

Cam Positioner H8PS

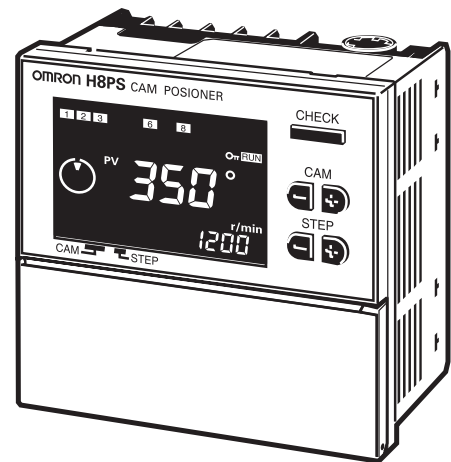

OPERATION MANUAL

Cam Positioner

H8PS

OPERATION MANUAL

PREFACE

Thank you for purchasing an H8PS Cam Positioner.

The H8PS Cam Positioner is a compact and highly functional controller for detecting angles of rotation. Its development has drawn on OMRON's advanced control technology and expertise in manufacturing various types of controllers.

This Operation Manual describes how to use the H8PS Cam Positioners.

Before using the H8PS Cam Positioner, read this manual carefully so that you can use it correctly. Keep the manual close at hand so that you can refer to it whenever necessary.

● Intended Audience

The Operation Manual is intended for the following readership.

- People in charge of introducing FA devices
- People who design FA systems
- People who install or connect FA devices
- People who manage working FA installations

Please note that persons who use this product must have sufficient knowledge of electrics.

Notice

- (1) All rights reserved. No part of this manual may be reprinted or copied without the prior written permission of OMRON.
- (2) The specifications and other information in this manual are subject to change without notice for purposes of improvement.
- (3) Considerable care has been taken in the preparation of this manual; however, OMRON assumes no responsibility or liability for any errors or inaccuracies that may appear. In the event that a problem is discovered, please contact one of the Omron offices or agents listed at the end of the manual, and provide the catalogue number shown on the cover of the manual.

Terms and Conditions Agreement

Warranty, Limitations of Liability

Warranties

- **Exclusive Warranty** Omron's exclusive warranty is that the Products will be free from defects in materials and workmanship for a period of twelve months from the date of sale by Omron (or such other period expressed in writing by Omron). Omron disclaims all other warranties, express or implied.

- **Limitations** OMRON MAKES NO WARRANTY OR REPRESENTATION, EXPRESS OR IMPLIED, ABOUT NON-INFRINGEMENT, MERCHANTABILITY OR FITNESS FOR A PARTICULAR PURPOSE OF THE PRODUCTS. BUYER ACKNOWLEDGES THAT IT ALONE HAS DETERMINED THAT THE PRODUCTS WILL SUITABLY MEET THE REQUIREMENTS OF THEIR INTENDED USE.

Omron further disclaims all warranties and responsibility of any type for claims or expenses based on infringement by the Products or otherwise of any intellectual property right.

- **Buyer Remedy** Omron's sole obligation hereunder shall be, at Omron's election, to (i) replace (in the form originally shipped with Buyer responsible for labor charges for removal or replacement thereof) the non-complying Product, (ii) repair the non-complying Product, or (iii) repay or credit Buyer an amount equal to the purchase price of the non-complying Product; provided that in no event shall Omron be responsible for warranty, repair, indemnity or any other claims or expenses regarding the Products unless Omron's analysis confirms that the Products were properly handled, stored, installed and maintained and not subject to contamination, abuse, misuse or inappropriate modification. Return of any Products by Buyer must be approved in writing by Omron before shipment. Omron Companies shall not be liable for the suitability or unsuitability or the results from the use of Products in combination with any electrical or electronic components, circuits, system assemblies or any other materials or substances or environments. Any advice, recommendations or information given orally or in writing, are not to be construed as an amendment or addition to the above warranty.

See <http://www.omron.com/global/> or contact your Omron representative for published information.

Limitation on Liability; Etc

OMRON COMPANIES SHALL NOT BE LIABLE FOR SPECIAL, INDIRECT, INCIDENTAL, OR CONSEQUENTIAL DAMAGES, LOSS OF PROFITS OR PRODUCTION OR COMMERCIAL LOSS IN ANY WAY CONNECTED WITH THE PRODUCTS, WHETHER SUCH CLAIM IS BASED IN CONTRACT, WARRANTY, NEGLIGENCE OR STRICT LIABILITY.

Further, in no event shall liability of Omron Companies exceed the individual price of the Product on which liability is asserted.

Application Considerations

Suitability of Use

Omron Companies shall not be responsible for conformity with any standards, codes or regulations which apply to the combination of the Product in the Buyer's application or use of the Product. At Buyer's request, Omron will provide applicable third party certification documents identifying ratings and limitations of use which apply to the Product. This information by itself is not sufficient for a complete determination of the suitability of the Product in combination with the end product, machine, system, or other application or use. Buyer shall be solely responsible for determining appropriateness of the particular Product with respect to Buyer's application, product or system. Buyer shall take application responsibility in all cases.

NEVER USE THE PRODUCT FOR AN APPLICATION INVOLVING SERIOUS RISK TO LIFE OR PROPERTY WITHOUT ENSURING THAT THE SYSTEM AS A WHOLE HAS BEEN DESIGNED TO ADDRESS THE RISKS, AND THAT THE OMRON PRODUCT(S) IS PROPERLY RATED AND INSTALLED FOR THE INTENDED USE WITHIN THE OVERALL EQUIPMENT OR SYSTEM.

Programmable Products

Omron Companies shall not be responsible for the user's programming of a programmable Product, or any consequence thereof.

Disclaimers

Performance Data

Data presented in Omron Company websites, catalogs and other materials is provided as a guide for the user in determining suitability and does not constitute a warranty. It may represent the result of Omron's test conditions, and the user must correlate it to actual application requirements. Actual performance is subject to the Omron's Warranty and Limitations of Liability.

Change in Specifications

Product specifications and accessories may be changed at any time based on improvements and other reasons. It is our practice to change part numbers when published ratings or features are changed, or when significant construction changes are made. However, some specifications of the Product may be changed without any notice. When in doubt, special part numbers may be assigned to fix or establish key specifications for your application. Please consult with your Omron's representative at any time to confirm actual specifications of purchased Product.

Errors and Omissions

Information presented by Omron Companies has been checked and is believed to be accurate; however, no responsibility is assumed for clerical, typographical or proofreading errors or omissions.

Precautions

Definition of Safety Notices and Information

The following notation is used in this manual to provide precautions required to ensure safe usage of the product.





The safety precautions that are provided are extremely important to safety. Always read and heed the information provided in all safety precautions.

The following notation is used.







Caution

Indicates a potentially hazardous situation which, if not avoided, may result in minor or moderate injury or in property damage.

● Symbols

Symbol		Meaning
Caution		General Caution Indicates non-specific general cautions, warnings and dangers.
		Electrical Shock Caution Indicates possibility of electric shock under specific conditions.
Prohibition		General Prohibition Indicates non-specific general prohibitions.
Mandatory Caution		General Caution Indicates non-specific general cautions, warnings, and dangers.

● **Precautionary Information**

 CAUTION	
<p>Do not touch the terminals when power is being supplied. For Surface-mounting H8PS, always connect the terminal cover for after completing wiring. Otherwise, minor injury due to electric shock may occasionally occur.</p>	
<p>Do not allow metal fragments, lead wire scraps, or chips from processing during installation to fall inside the H8PS. Otherwise, minor electric shock, fire, or malfunction may occasionally occur.</p>	
<p>Tighten terminal screws to a torque of 0.8 N·m so that they do not become loose. Minor fires or malfunction may occasionally occur.</p>	
<p>For 16- and 32-output Models, leave the protective label attached to the H8PS when wiring. Removing the label before wiring may occasionally result in fire if foreign matter enters the Unit. Remove the label after the completion of wiring to ensure proper heat dissipation. Leaving the label attached may occasionally result in fire.</p>	
<p>Do not disassemble, modify, or repair the H8PS or touch any of the internal parts. Otherwise, minor electric shock, fire, or malfunction may occasionally occur.</p>	

Precautions for Safe Use

Observe the following items to ensure the safe use of this product.

Environmental Precautions

- Store the H8PS within specified ratings. If the H8PS has been stored at temperatures -10°C or lower, let it stand for 3 hours or longer at room temperature before turning ON the power supply.
- Use the H8PS within the specified ratings for operating temperature and humidity.
- Do not operate the H8PS in locations subject to sudden or extreme changes in temperature, or locations where high humidity may result in condensation.
- Do not use the H8PS in locations subject to vibrations or shock. Extended use in such locations may result in damage due to stress.
- Do not use the H8PS in locations subject to excessive dust, corrosive gas, or direct sunlight.
- Install the H8PS well away from any sources of static electricity, such as pipes transporting molding materials, powders, or liquids.
- The H8PS is not waterproof or oil resistant.
Do not use it in locations subject to water or oil.
- The life expectancy of internal components may be reduced if the H8PS is mounted side-by-side.
- Do not use organic solvents (such as paint thinner or benzene), strong alkaline, or strong acids because they will damage the external finish.

Usage Precautions

- Install a switch or circuit breaker that allows the operator to immediately turn OFF the power, and label it to clearly indicate its function.
- Pay careful attention to polarity to avoid wrong connections when wiring terminals.
- Do not connect more than two crimp terminals to the same terminal.
- Use the specified wires for wiring.
Applicable Wires
AWG24 to AWG18 (cross-sectional area of 0.208 to 0.832 mm^2)
Solid or twisted wires of copper
- Do not connect loads that exceed the rated output current. The output elements may be destroyed, possibly resulting in short-circuit or open-circuit faults.
- Always connect a diode to protect against counterelectromotive force when using an inductive load. Counterelectromotive force may destroy output elements, possibly resulting in short-circuit or open-circuit faults.
- Use the specified cables to connect outputs.
- Do not install input lines in the same duct or conduit as power supply or other high-voltage lines. Doing so may result in malfunction due to noise. Separate the input lines from high-voltage lines.

- Internal elements may be destroyed if a voltage outside the rated voltage is applied.
- Maintain voltage fluctuations in the power supply within the specified range.
- Use a switch, relay, or other contact so that the rated power supply voltage will be reached within 0.1 s. If the power supply voltage is not reached quickly enough, the H8PS may malfunction or outputs may be unstable.
- Do not turn OFF the power supply when changing or deleting settings. The contents of the EEPROM may be corrupted.

Precautions for Correct Use

- (1) When using the Y92C-30 Parallel Operation Adapter for parallel operation, do not connect more than two Positioners to the same encoder.
- (2) Do not subject the connectors of outputs, encoder on the Positioner to more than 30 N of force.
- (3) Keep the USB cable connector straight when connecting or disconnecting it. Otherwise the Positioner or connector may be damaged.
- (4) Confirm the waveform of the power supply circuit and install a surge absorber. Surge or noise applied to the power supply may destroy internal elements or cause malfunctions.
- (5) Switch the power supply circuit with a device rated at 3.5 A or higher.
- (6) Inrush current of approximately 3.5 A will flow for a short period of time when the power supply is turned ON. The Positioner may not start if the capacity of the power supply is not sufficient. Be sure to use a power supply with sufficient capacity.
- (7) EEPROM is used as memory when the power is interrupted. The write life of the EEPROM is 100,000 writes. The EEPROM is written when settings are changed, settings are deleted, or the resolution is changed.
- (8) Make sure that all settings are appropriate for the application. Unexpected operation resulting in property damage or accidents may occur if the settings are not appropriate.
- (9) Inputs signals may be accepted, not accepted, or unstable for the following times when the power supply is turned ON or OFF. Set the system to allow leeway in the timing of input signals. Approximately 1 second is required from the time the power supply is turned ON until outputs are made.

For information on other timing, refer to "Appendix D Operation Timing Chart" in this manual.

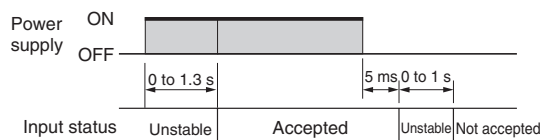

- (10) If you use the output cable, connect the minus (-) terminal and all of the COM terminals. For a PNP output, connect all Vs terminals. If you do not connect all of the terminals with the same name, the current will be concentrated on the connected terminals and the ratings of the parts may be exceeded.

(11) When connecting only one Positioner to the Parallel Operation Adapter, connect the cable with the ▲ mark.

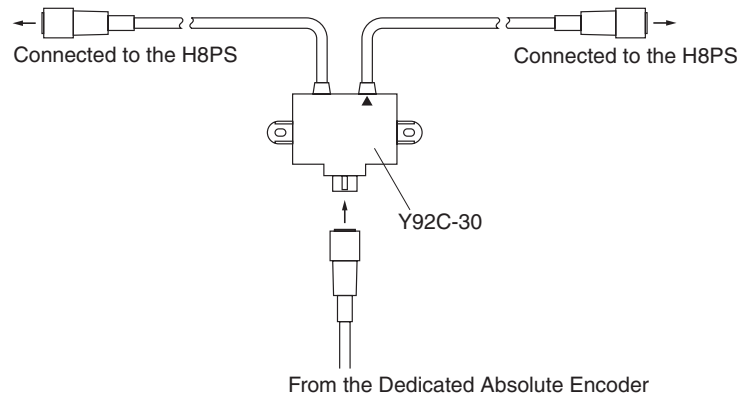

About this Manual

■ Contents of the Manual

Section	Contents
Section 1 OUTLINE	Explains the features of the H8PS Cam Positioner and gives outlines of its functions.
Section 2 INSTALLATION	Explains how to mount and wire an H8PS Cam Positioner, and how to connect it to an encoder.
Section 3 HOW TO USE THE BASIC FUNCTIONS	Explains the operating procedures to take the H8PS Cam Positioner up to the point where it is ready for operation. The H8PS Cam Positioner can be operated using just the basic functions described in this Section.
Section 4 HOW TO USE THE ADVANCED FUNCTIONS	Explains the operating procedures for getting the most out of the convenient and higher-level functions that your H8PS Cam Positioner offers.
APPENDICES	Presents specifications, error messages, and other information.

■ Indication of Applicable Models

In this manual the applicable models in a particular context are sometimes indicated in the following way.

8 output

Models with 8 cam outputs (H8PS-8□)

16 output

Models with 16 cam outputs (H8PS-16□)

32 output

Models with 32 cam outputs (H8PS-32□)

Revision History

The revision code of this manual can be found appended to the manual number (referred to as the "catalog number") at the bottom left of the front and back covers.

Cat. No. Z199-E1-02

↑ Revision code

Revision code	Date of revision	Page, details of change
01	May 2004	First edition
02	April 2015	Made corrections related to revision of EN 61326-1. Page A-2: Added information on electromagnetic environment. Corrected mistakes.

Contents

PREFACE	II
Precautions	V
Precautions for Safe Use	VII
Precautions for Correct Use	-IX
About this Manual	-XI
Revision History	XII

Section 1 OUTLINE

1.1 Outline	1-2
1.2 Features	1-3
1.3 System Configuration	1-7
1.3.1 8-output Model	1-7
1.3.2 16-/32-output Model	1-8
1.4 Table of Product Models	1-9
1.5 Nomenclature	1-11
1.5.1 8-output Models (H8PS-8£)	1-11
1.5.2 16-/32-output Models (H8PS-16£/-32£)	1-12

Section 2 INSTALLATION

2.1 Designing the System	2-2
2.1.1 Selecting the Encoder	2-2
2.1.2 Selecting the Output Cable	2-5
2.2 Mounting (Cam Positioner)	2-6
2.2.1 Dimensions	2-6
2.2.2 Mounting Method	2-8
2.2.3 Encoder Connecting Direction	2-14
2.3 Mounting (Encoder)	2-15
2.3.1 Dimensions and Mounting Method	2-15
2.3.2 Accessories (Order Separately)	2-18
2.3.3 Safety Precautions (Encoder)	2-20
2.3.4 Parallel Input Adapters (Order Separately)	2-22
2.4 Wiring	2-24
2.4.1 System Connection Diagram	2-24
2.4.2 Terminal Arrangement	2-25
2.4.3 Input Connections	2-29
2.4.4 Output Connections	2-30

Section 3 HOW TO USE THE BASIC FUNCTIONS

3.1 Operation Basics	3-2
3.2 Preparatory Steps before Starting Operation	3-4
3.3 DIP Switch Setting	3-5
3.3.1 Selecting the Encoder Resolution	3-5
3.3.2 Setting the Rotation Direction	3-6
3.4 Setting the Origin	3-7
3.5 Setting the ON/OFF Angles	3-8
3.5.1 Setting the ON/OFF Angles in the Manual Mode (Key Input)	3-10
3.5.2 Setting the ON/OFF Angles in the Teach Mode	3-11
3.6 Checking the Operation Timing	3-12

3.7	Operation	3-13
3.8	Clearing the Settings	3-15
3.8.1	Clearing Items Individually	3-16
3.8.2	All Clear (Deletes all programming)	3-17
3.9	Checking the Settings in the Run Mode	3-18
3.10	Switching the Display between Speed and Angle	3-19
3.11	All Protection Function	3-20

Section 4 HOW TO USE THE ADVANCED FUNCTIONS

4.1	Mode Transitions	4-2
4.2	Advance Angle Compensation (ADV) Function	4-4
4.2.1	What Is the Advance Angle Compensation (ADV) Function?	4-4
4.2.2	Specifications of Advance Angle Compensation Function Setting	4-5
4.2.3	Operation	4-9
4.3	Prohibiting Outputs	4-11
4.4	Pulse Output (F1/F2).....	4-12
4.4.1	Setting the Number of Pulse Outputs (F1)	4-13
4.4.2	Setting the Pulse Output Start Angle (F2)	4-14
4.5	Speed Alarm (F3/F4).....	4-15
4.5.1	Setting the Speed Alarm (Upper Limit) (F3)	4-16
4.5.2	Setting the Speed Alarm (Lower Limit) (F4)	4-18
4.6	Step Number Limit (F5).....	4-20
4.7	Cam Protection (F6).....	4-23
4.8	Bank Function (F7/F8/F9)	4-24
4.8.1	What Is the Bank Function?	4-24
4.8.2	Switching the Active Bank	4-25
4.8.3	Designating the Bank Using the Keys	4-27
4.8.4	Bank Switching Timing	4-28
4.8.5	Enabling the Bank (F7)	4-29
4.8.6	Selecting the Bank Switching Method (F8)	4-30
4.8.7	Bank Copy (F9)	4-31
4.9	E24 Detection Enable/Disable (F10).....	4-32

APPENDICES

Appendix A	Specifications (Ratings)	A-2
Appendix B	Troubleshooting	A-5
Appendix C	List of Settings	A-11
Appendix D	Operation Timing Chart	A-14
Appendix E	Angle Data Table (256 Resolution)	A-16
Appendix F	Coding Sheet	A-17

Section 1 OUTLINE

1.1	Outline	1-2
1.2	Features.....	1-3
1.3	System Configuration	1-7
1.4	Table of Product Models	1-9
1.5	Nomenclature	1-11

1.1 Outline

The H8PS Cam Positioner is an electronic cam switch that allows you to make complicated ON/OFF angle settings in a simple operation.

Conventionally, a combination of a mechanical cam and a limit switch (or photoelectric sensor) was used to detect angles of rotation.

This conventional method, however, required a very cumbersome process when adjusting an angle.

The H8PS Cam Positioner detects angles of rotation using an absolute encoder (a sensor that detects the absolute angle of rotation) to turn the output signal on and off at the preset ON/OFF angles (referred to as the "cam program").

The H8PS Cam Positioner can replace existing mechanical cam switches.

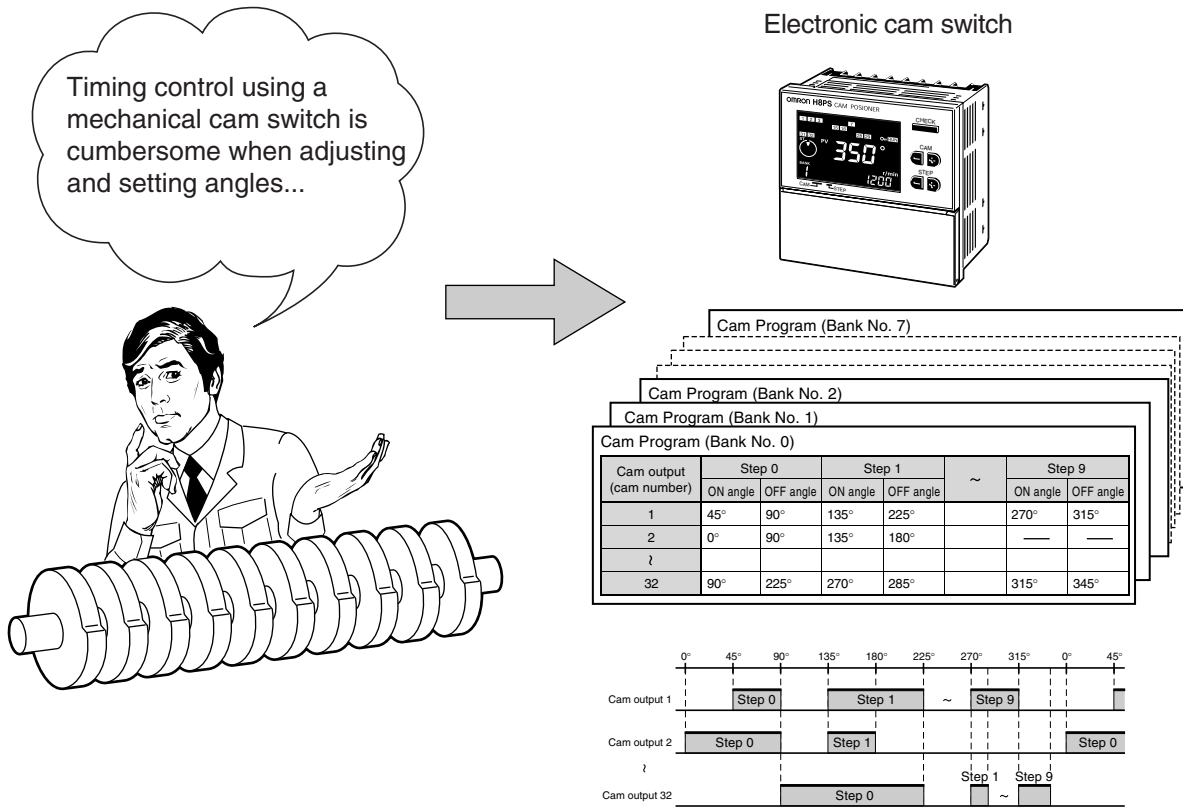

The H8PS Cam Positioner offers a number of advantages over a cam positioner unit of a PLC (programmable logic controller), including its easy-to-read display and the simple procedure for changing settings. Also you do not have to consider the adverse affect of scan time.

1.2 Features

The H8PS Cam Positioner offers the features described below.

For details, refer to Sections 3 and 4 in this Operation Manual.

Basic Functions

8 output 16 output 32 output

Available in three series with different numbers of cam outputs - 8/16/32

The basic functions described below are common to all 8-/16-/32-output models.

There are three series of the H8PS Cam Positioner providing different numbers of outputs, i.e., 8, 16 or 32 outputs. The number of outputs can be expanded to a maximum of 64 (using two units of 32-output model) by using a Y92C-30 Parallel Input Adapter, so that the most appropriate model may be chosen to suit the scale and application of the equipment.

The size of each cam positioner unit is a compact 1/4-DIN size for all three series for space-saving installation.

The wide range of models also allows you to choose the most suitable mounting method (flush-mounting model or surface-mounting model), configuration of outputs (NPN or PNP), and panel language (Japanese or English).

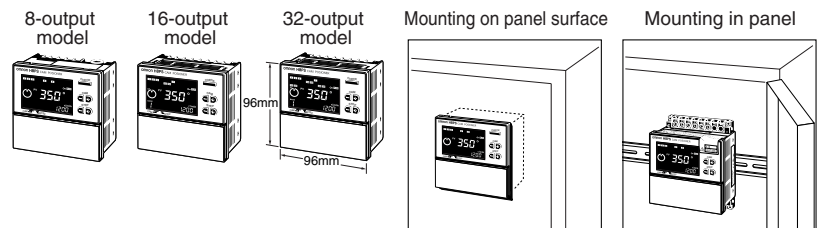

Choice of resolutions (256/360/720)

You can select the resolution of the absolute encoder from three levels: 256, 360, or 720. The angle of rotation can be controlled in units as small as 0.5° (at a resolution of 720).

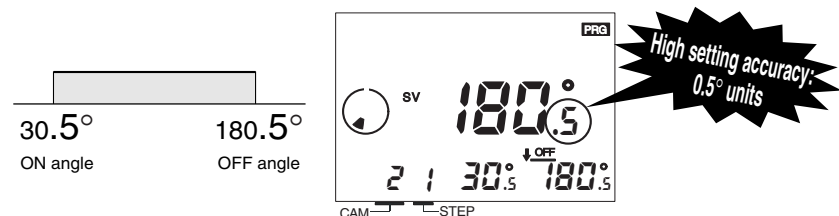

Suitable for high-speed operation up to 1600 r/min

Since the H8PS Cam Positioner is able to respond in high-speed operation up to a maximum of 1600 r/min (at a resolution of 256 or 360), it can be used in a wide range of applications.

- Can be used as a rotation meter using the rotational speed display function

The H8PS Cam Positioner can always display the rotational speed and present angle on the same display screen. It is also possible to display the rotational speed in enlarged characters as Main display. In applications where a rotation meter is independently installed, installing one H8PS Cam Positioner can satisfy the user's requirements.

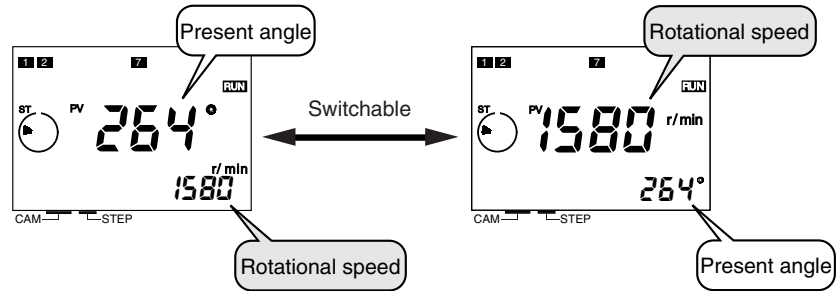

- Can be connected at a distance of up to 100 m from the control target equipment

The encoder cable can be extended to a length of up to 100 m. Operation is reliable even if the cam positioner is installed at a distance from the control target equipment (encoder mounting position).

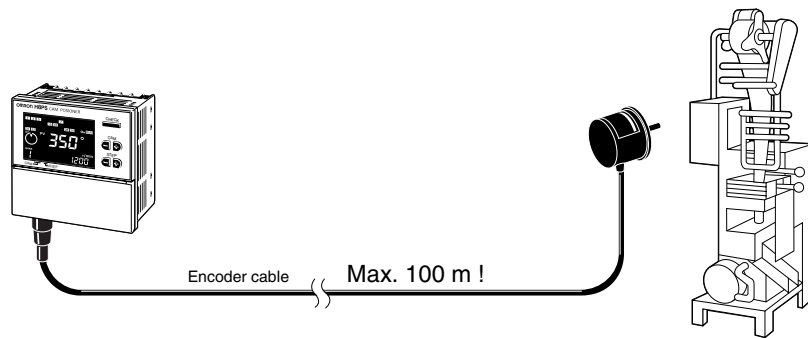

- Facility to set the desired number of output pulses and the desired pulse output starting angle

You can output the desired number of pulses at the desired timing during one turn of the encoder. Since a variety of devices can be connected to the cam positioner and it is easy to set the pulse output starting angle, it has many applications in addition to displaying revolution speeds, such as setting the timing of systems.

Refer to "4.4 Pulse Output (F1/F2)".

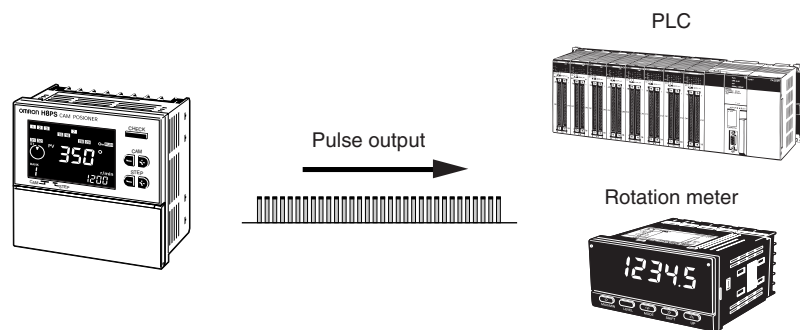

■ Convenient/Advanced Functions

● Advance angle compensation function

8 output 16 output 32 output

This function advances the ON/OFF timing from the preset angle in proportion to the rotational speed of the machine (encoder). It automatically compensates for the delay in output timing during high-speed operation, eliminating the need to switch the program according to the operation speed that is a characteristic of conventional systems.

Refer to "4.2 Advance Angle Compensation (ADV) Function".

Example When 2° is set to the angle advancement for a rotational speed of 100 r/min

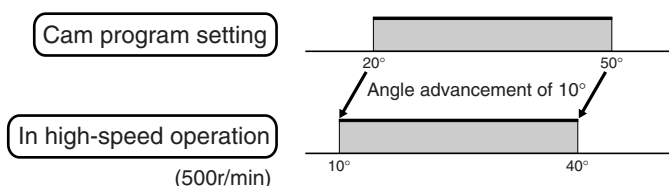

● Bank function

16 output 32 output

The bank function allows registration of up to eight types of programs. You can switch among them simply by selecting a desired program when changing a setup or the targeted type of a workpiece.

The bank function also simplifies programming since it offers a program copy function.

Refer to "4.8 Bank Function (F7/F8/F9)".

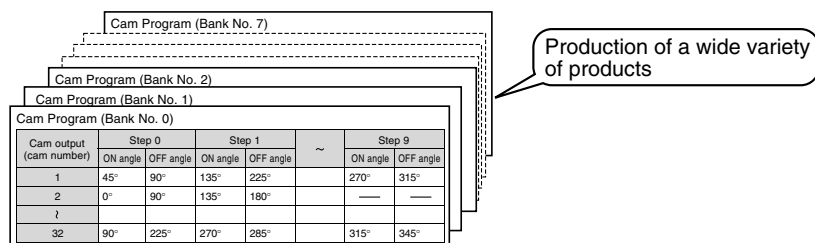

● Rotational speed alarm (upper limit/lower limit) function

8 output 16 output 32 output

It is possible to set upper and lower limit values for the rotational speed. When the actual rotational speed exceeds the upper-limit value or falls below the lower-limit value, the corresponding alarm is output.

Refer to "4.5 Speed Alarm (F3/F4)".

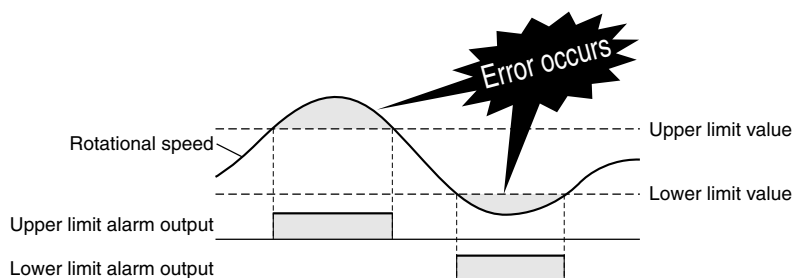

● All protect function

8 output 16 output 32 output

The all protect function disables all the operations (keys and switches) during Run mode operation. This function prevents operation errors and protects the H8PS Cam Positioner from unauthorized operation.

Refer to "3.11 All Protection Function".



● Cam protection function

8 output 16 output 32 output

The cam protection function allows you to set protection for individual cams so that the programmed values of specific cams are protected from inadvertent access during operation. This function can also be used to allow user access to the specified cams only. Effective use of this function enables the configuration of a safe and user-friendly human interface.

● Step-number limit function

8 output 16 output 32 output

The H8PS Cam Positioner allows the setting of up to 10 steps (10 sets of ON/OFF) for each cam (up to 160 steps in total).

The step-number limit function limits the number of usable steps to prevent an addition of a program by mistake.

Refer to "4.6 Step Number Limit (F5)".

1.3 System Configuration

1.3.1 8-output Model

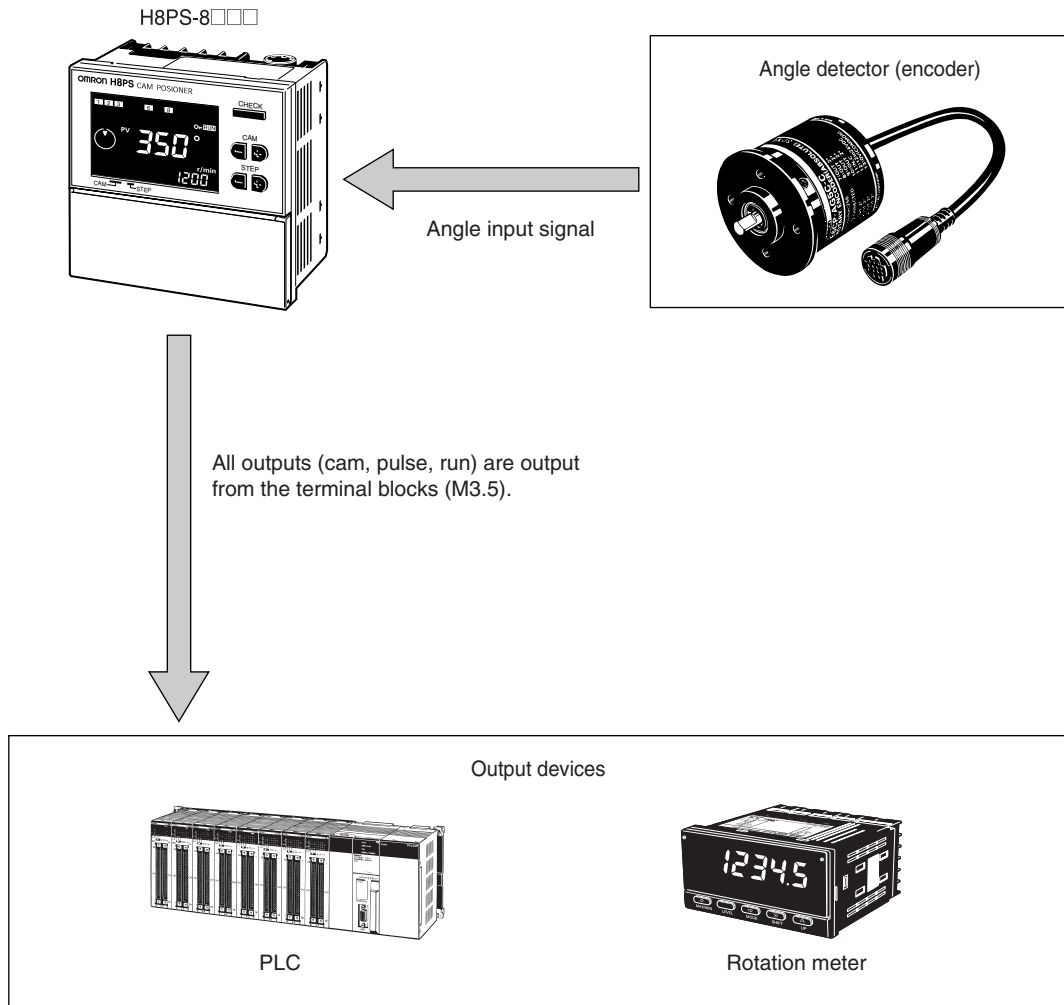

1.3.2 16-/32-output Model

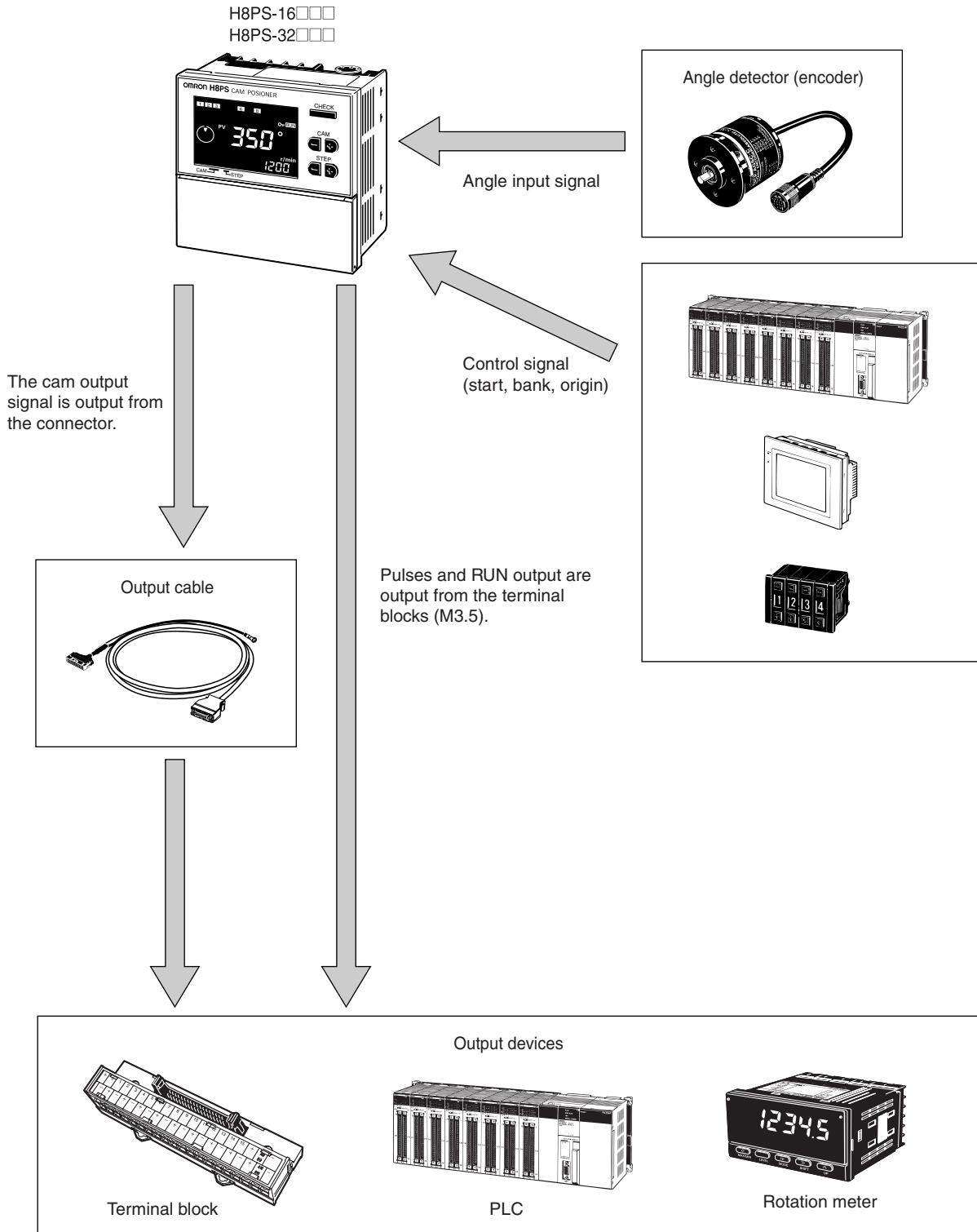

1.4 Table of Product Models

■ Model Number Legend

H8PS-□□□□
1 2 3 4

- | | | | |
|----------------------|-------------------|--|-----------------------------|
| 1. Number of outputs | 2. Panel language | 3. Mounting method | 4. Output configuration |
| 8: 8 outputs | B: English | None: Flush mounting | None: NPN transistor output |
| 16: 16 outputs | | F: Surface mounting/
track mounting | P: PNP transistor output |
| 32: 32 outputs | | | |

■ Cam Positioner

Number of outputs	Mounting method	Output configuration	Bank function	Model
8 outputs	Flush mounting	NPN transistor output	No	H8PS-8B
		PNP transistor output		H8PS-8BP
	Surface mounting/ track mounting	NPN transistor output		H8PS-8BF
		PNP transistor output		H8PS-8BFP
16 outputs	Flush mounting	NPN transistor output	Yes	H8PS-16B
		PNP transistor output		H8PS-16BP
	Surface mounting/ track mounting	NPN transistor output		H8PS-16BF
		PNP transistor output		H8PS-16BFP
32 outputs	Flush mounting	NPN transistor output		H8PS-32B
		PNP transistor output		H8PS-32BP
	Surface mounting/ track mounting	NPN transistor output		H8PS-32BF
		PNP transistor output		H8PS-32BFP

■ Dedicated Absolute Encoder

Type	Resolution	Cable length	Model
Economy	256	2 m	E6CP-AG5C-C 256P/R 2M
Standard	256	1 m	E6C3-AG5C-C 256P/R 1M
		2 m	E6C3-AG5C-C 256P/R 2M
	360		E6C3-AG5C-C 360P/R 2M
	720	E6C3-AG5C-C 720P/R 2M	
Rigid	256	2 m	E6F-AG5C-C 256P/R 2M
	360		E6F-AG5C-C 360P/R 2M
	720		E6F-AG5C-C 720P/R 2M

■ Accessories (Order Separately)

Name	Specifications	Model
Discrete Wire Output Cable	2 m	Y92S-41-200
Connector-type Output Cable	2 m	E5ZE-CBL200
Support Software	CD-ROM	H8PS-SOFT-V1
Shaft Coupling for the E6CP	Axis: 6 mm dia.	E69-C06B
Shaft Coupling for the E6C3	Axis: 8 mm dia.	E69-C08B
Shaft Coupling for the E6F	Axis: 10 mm dia.	E69-C10B
Extension Cable (*)	5 m (same for E6CP, E6C3, and E6F)	E69-DF5
Parallel Input Adapter	Two Units can operate in parallel.	Y92C-30
Protective Cover	---	Y92A-96B
Watertight Cover	---	Y92A-96N
Track Mounting Base	---	Y92F-91
Mounting Track	50 cm × 7.3 mm (l × t)	PFP-50N
	1 m × 7.3 mm (l × t)	PFP-100N
	1 m × 16 mm (l × t)	PFP-100N2
End Plate	---	PFP-M
Spacer	---	PFP-S

* Ask your OMRON representative about the availability of non-standard lengths.

● Recommended USB Cables

Name	Recommended manufacturer	Specifications	Model
USB Cable	ELECOM CO. Ltd.	A-mini B, 2 m	U2C-MF20BK

Note: If you cannot purchase the recommended replacement cable, purchase a commercially available USB cable with a ferrite core attached to it.

1.5 Nomenclature

1.5.1 8-output Models (H8PS-8□)

● Displays

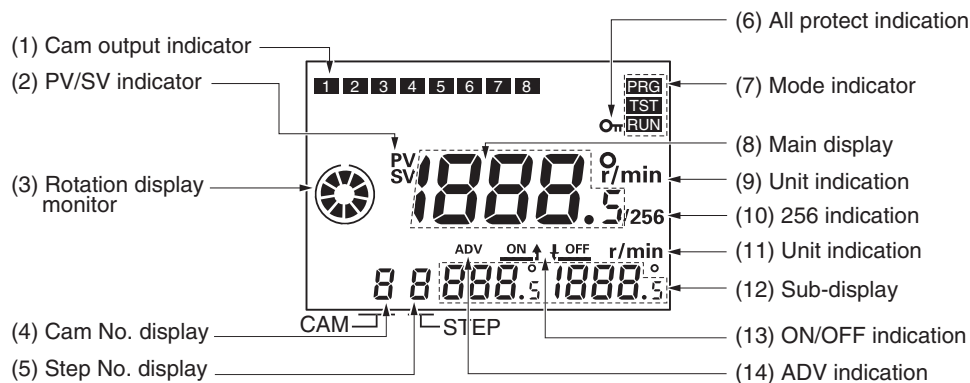

No.	Display color	Description
(1)	Orange	Lit while cam outputs are ON.
(2)	Red	PV: Lit while the present angular position or speed is displayed in Main display. SV: Lit while the setting value is displayed in Main display.
(3)	Orange	Displays Encoder present angular position, direction, and speed guidelines.
(4)	Green	Displays the cam number for the angle setting displayed on Sub-display.
(5)	Green	Displays the step number for the angle setting displayed on Sub-display.
(6)	Orange	Lit while the All Protection function is enabled.
(7)	Orange	The indicator for the selected mode is lit. PRG: Programming Mode TST: Test Mode RUN: Run Mode
(8)	Red	Displays the present angular position or the speed and settings being made.
(9)	Red	Displays units for the angle or the speed displayed on Main display.
(10)	Red	Lit while using an Encoder with a resolution of 256 if 256° display is selected.
(11)	Green	Displays units for the angle or the speed displayed on Sub-display.
(12)	Green	Displays the speed or the ON/OFF angle settings.
(13)	Green	Indicates whether Main display displays the ON or OFF angle setting.
(14)	Green	Lit while setting the Advance Angle Compensation (ADV) Function.

● Operation Buttons and Keys

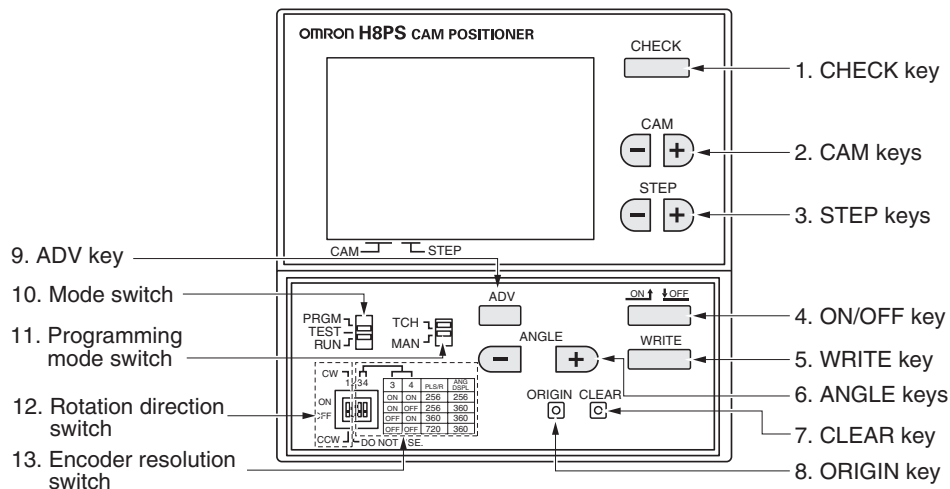

No.	Description
1	Displays program details in Run Mode.
2	Selects the cam number with $\boxed{+}$ $\boxed{-}$ Keys.
3	Selects the step number with $\boxed{+}$ $\boxed{-}$ Keys.
4	Selects the ON angle, or OFF angle.
5	Writes the set data to memory.
6	Changes the angle or other setting value with $\boxed{+}$ $\boxed{-}$ Keys.
7	Moves to the screen for clearing settings.
8	Designates the current angle of the machine (Encoder) as the origin (0°).
9	<p>Programming or Test Mode: Press to shift to the ADV function setting screen.</p> <p>Programming Mode: Press and hold at least 3 s to shift to the Function Setting Mode.</p> <p>Run Mode: Press and hold at least 5 s to enable/disable the All Protection function.</p>
10	<p>Switches modes.</p> <p>Programming Mode (PRGM): Used to write cam programs, set the ADV function, etc.</p> <p>Test Mode (TEST): Used to modify settings while the Encoder is running.</p> <p>Run Mode (RUN): Used for normal operation and to check the cam program.</p>
11	<p>Select the method used for programming cams.</p> <p>Teaching: ON/OFF Angles can be set based on actual machine (Encoder) operation.</p> <p>Manual: ANGLE Keys can be used to set ON/OFF angles.</p>
12	Sets the H8PS rotation direction (rotation display monitor, etc.) to the machine (Encoder) rotation direction.
13	<p>Sets the resolution of the connected Encoder.</p> <p>Also sets the unit for angle display when using an Encoder with a resolution of 256.</p>

1.5.2 16-/32-output Models (H8PS-16□/-32□)

● Displays

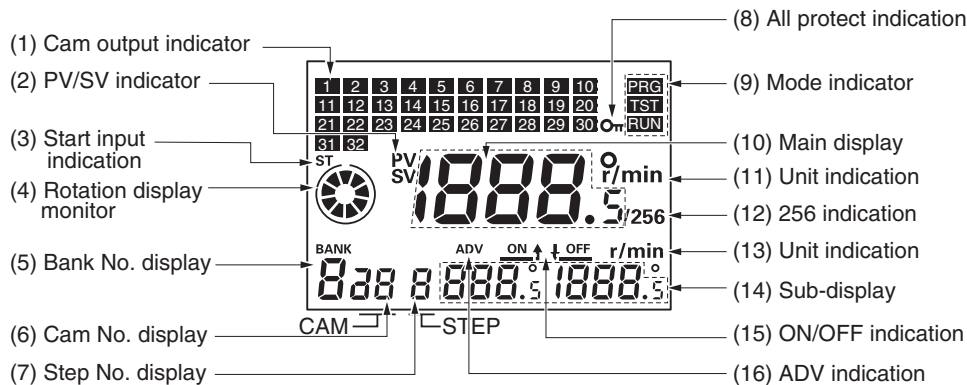

- * The illustration above shows the display section of a 32-output model.
16-output models have an output display covering 1 to 16 only.

No.	Display color	Description
(1)	Orange	Lit while cam outputs are ON.
(2)	Red	PV: Lit while the present angular position or speed is displayed in Main display. SV: Lit while the setting value is displayed in Main display.
(3)	Orange	Lit while the start input is ON in Run or Test Mode. Not lit when an error occurs.
(4)	Orange	Displays Encoder present angular position, direction, and speed guidelines.
(5)	Green	Displays the bank number that is running in Run or Test Mode and the bank number selected in Programming Mode.
(6)	Green	Displays the cam number for the angle setting displayed on Sub-display.
(7)	Green	Displays the step number for the angle setting displayed on Sub-display.
(8)	Orange	Lit while the All Protection function is enabled.
(9)	Orange	The indicator for the selected mode is lit. PRG: Programming Mode TST: Test Mode RUN: Run Mode
(10)	Red	Displays the present angular position or the speed and settings being made.
(11)	Red	Displays units for the angle or the speed displayed on Main display.
(12)	Red	Lit while using an Encoder with a resolution of 256 if 256° display is selected.
(13)	Green	Displays units for the angle or the speed displayed on Sub-display.
(14)	Green	Displays the speed or the ON/OFF angle settings.
(15)	Green	Indicates whether Main display displays the ON or OFF angle setting.
(16)	Green	Lit while setting the Advance Angle Compensation (ADV) Function.

● Operation Buttons and Keys

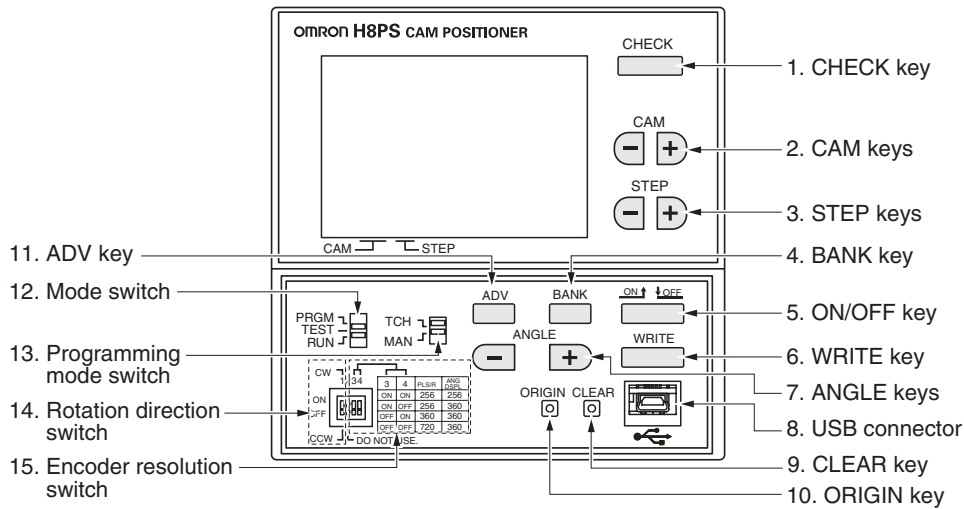

No.	Description
1	Displays program details in Run Mode.
2	Selects the cam number with $\boxed{+}$ $\boxed{-}$ Keys.
3	Selects the step number with $\boxed{+}$ $\boxed{-}$ Keys.
4	Selects the bank number.
5	Selects the ON angle, or OFF angle.
6	Writes the set data to memory.
7	Changes the angle or other setting value with $\boxed{+}$ $\boxed{-}$ Keys.
8	USB communications are scheduled to be supported in the near future.
9	Moves to the screen for clearing settings.
10	Designates the current angle of the machine (Encoder) as the origin (0°).
11	Programming or Test Mode: Press to shift to the ADV function setting screen. Programming Mode: Press and hold at least 3 s to shift to the Function Setting Mode. Run Mode: Press and hold at least 5 s to enable/disable the All Protection function.
12	Switches modes. Programming Mode (PRGM): Used to write cam programs, set the ADV function, etc. Test Mode (TEST): Used to modify settings while the Encoder is running. Run Mode (RUN): Used for normal operation and to check the cam program.
13	Select the method used for programming cams. Teaching: ON/OFF Angles can be set based on actual machine (Encoder) operation. Manual: ANGLE Keys can be used to set ON/OFF angles.
14	Sets the H8PS rotation direction (rotation display monitor, etc.) to the machine (Encoder) rotation direction.
15	Sets the resolution of the connected Encoder. Also sets the unit for angle display when using an Encoder with a resolution of 256.

Section 2 *INSTALLATION*

2.1	Designing the System.....	2-2
2.2	Mounting (Cam Positioner)	2-6
2.3	Mounting (Encoder)	2-15
2.4	Wiring	2-24

2.1 Designing the System

2.1.1 Selecting the Encoder

The three series (eight models) of dedicated absolute encoder products shown below are available.

Choose the most appropriate model for your application.

Note that the encoders can be used with all the H8PS-series Cam Positioners.

Refer to the relevant datasheet for details.

■ Dedicated Absolute Encoder

Type	Description	Resolution	Cable length	Model
Economy	Low-cost products	256	2 m	E6CP-AG5C-C 256P/R 2M
Standard	Standard products that can be used in environments where the encoder is directly exposed to water or oil	256	1 m	E6C3-AG5C-C 256P/R 1M
		360	2 m	E6C3-AG5C-C 256P/R 2M
				E6C3-AG5C-C 360P/R 2M
720	E6C3-AG5C-C 720P/R 2M			
Rigid	Ruggedly constructed products with high allowable shaft load tolerance that can be used in environments where the encoder is directly exposed to water or oil	256	2 m	E6F-AG5C-C 256P/R 2M
		360		E6F-AG5C-C 360P/R 2M
		720		E6F-AG5C-C 720P/R 2M

■ Ratings and Characteristics

Item	E6CP-AG5C-C	E6C3-AG5C-C	E6F-AG5C-C
Rated supply voltage	12 VDC – 10% to 24 VDC +15%, ripple (p-p) 5% max.		
Current consumption (*1)	70 mA max.		60 mA max.
Resolution (pulses per revolution)	256 (8-bit)	256 (8-bit), 360 (9-bit), or 720 (10-bit)	
Output code	Gray binary		
Output configuration	NPN open-collector output		
Output capacity	Applied voltage: 28 VDC max. Sink current: 16 mA max. Residual voltage: 0.4 V max. (sink current at 16 mA)	Applied voltage: 30 VDC max. Sink current: 35 mA max. Residual voltage: 0.4 V max. (sink current at 35 mA)	
Logic	Negative logic (H = 0, L = 1)		
Accuracy	Within $\pm 1^\circ$		
Rotation direction	Clockwise (viewed from the shaft) for output code increment		
Rise and fall times of output	1.0 μ s max. (control output voltage: 16 V; load resistance: 1 k Ω output cord: 2 m max.)	1.0 μ s max. (control output voltage: 5 V; load resistance: 1 k Ω ; output cord: 2 m max.)	
Starting torque	0.98 m N·m max.	10 m N·m max. (at room temperature), 30 m N·m max. (at low temperature)	9.8 m N·m max. (at room temperature), 14.7 m N·m max. (at low temperature)
Moment of inertia	1×10^{-6} kg·m ² max.	2.3×10^{-6} kg·m ² max.	1.5×10^{-6} kg·m ² max.
Shaft-load tolerance	Radial	30 N	120 N
	Thrust	20 N	50 N
Max. permissible rotation	1000 r/min	5000 r/min	
Ambient temperature	– 10 to 55°C (with no icing)	– 10 to 70°C (with no icing)	
Storage temperature	– 25 to 85°C (with no icing)		
Ambient humidity	35% to 85% (with no condensation)		
Degree of protection	IEC standard IP50	IEC standard IP65 (JEM standard IP65f) (*2)	IEC standard IP65 (JEM standard IP65f)
Insulation resistance	20 M Ω min. (at 500 VDC) between charged parts and the case		
Dielectric strength	500 VAC, 50/60 Hz for 1 min between charged parts and the case		

Item	E6CP-AG5C-C	E6C3-AG5C-C	E6F-AG5C-C
Vibration resistance	Destruction: 10 to 55 Hz, 1.5-mm double amplitude for 2 hr each in X, Y, and Z directions	Destruction: 10 to 500 Hz, 2-mm double amplitude, 150 m/s ² 3 times each in X, Y, and Z directions, 11-min sweep time	Destruction: 10 to 500 Hz, 1.5-mm double amplitude 3 times each in X, Y, and Z directions, 11-min sweep time
Shock resistance	Destruction: 1,000 m/s ² 3 times each in X, Y, and Z directions		
Weight	Approx. 200 g (with 2-m cord)	Approx. 300 g (with 1-m cord)	Approx. 500 g (with 2-m cord)
Datasheet Cat. No.	---	F058	E283

*1: The rush current indicated below will flow when the power is switched on.

Model E6CP-AG5C-C: Approx. 8 A (Time: Approx. 0.3 ms)

Model E6C3-AG5C-C: Approx. 6 A (Time: Approx. 0.8 ms)

Model E6F-AG5C-C: Approx. 9 A (Time: Approx. 5 μ s)

*2: JEM1030: Applied in 1991

■ Options

Name	Specifications	Model
Shaft Coupling for the E6CP	Axis: 6 mm dia.	E69-C06B
Shaft Coupling for the E6C3	Axis: 8 mm dia.	E69-C08B
Shaft Coupling for the E6F	Axis: 10 mm dia.	E69-C10B
Extension Cable (*)	5 m (same for E6CP, E6C3, and E6F)	E69-DF5
Parallel Input Adapter	Two Units can operate in parallel.	Y92C-30

* Ask your OMRON representative about the availability of non-standard lengths.

2.1.2 Selecting the Output Cable

■ Model H8PS-8□ (8-output model)

The cam outputs of 8-output model cam positioners are output from the M3.5 terminal block of the cam positioner unit.

No dedicated cable is provided, so the user should prepare the output cable.

■ Models H8PS-16□ (16-output model) and H8PS-32□ (32-output model)

With these models of cam positioner, cam outputs are output from the connector.

The two types of dedicated cables explained below are available and you should choose the one that suits your application.

For the terminal arrangement of the connector, refer to "2.4.2 Terminal Arrangement".

● Connector-type Output Cable (E5ZE-CBL200)

The cable length is approximately 2 m.

Using this type of cable, terminal blocks (XW2D, etc.) can be connected directly.

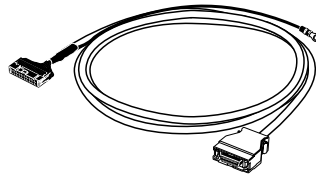

● Discrete Wire Output Cable (Y92S-41-200)

The cable length is approximately 2 m.

One end of the cable is discrete wires so that the wires can be treated appropriately according to the application.

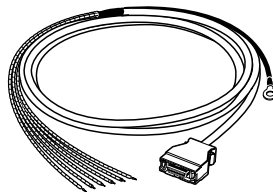

2.2 Mounting (Cam Positioner)

2.2.1 Dimensions

■ Flush Mounting H8PS-8□ (8-output Models)

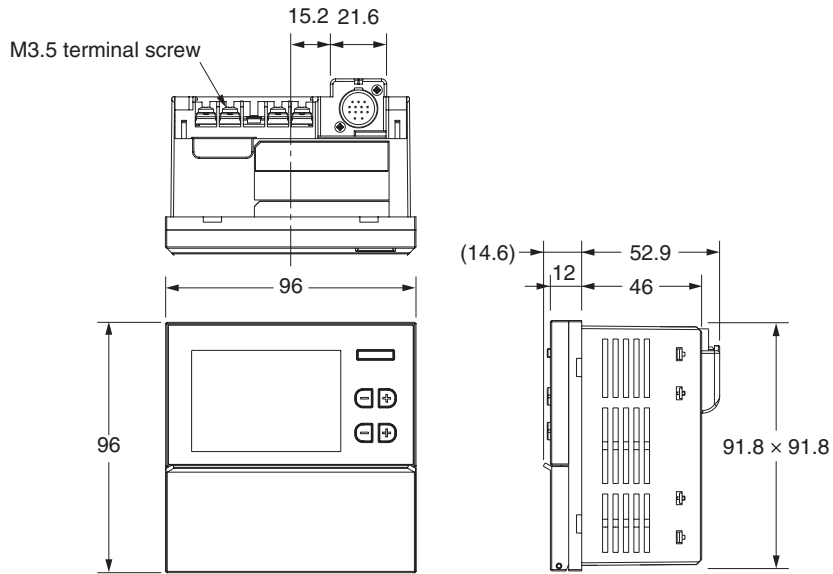

■ Surface Mounting H8PS-8□F□ (8-output Models)

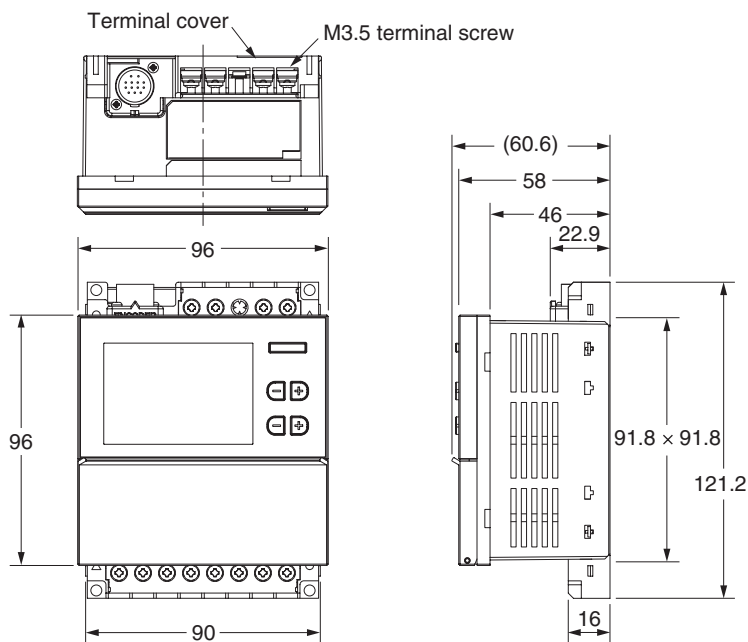

■ Flush Mounting H8PS-16□/32□ (16-/32-output Models)

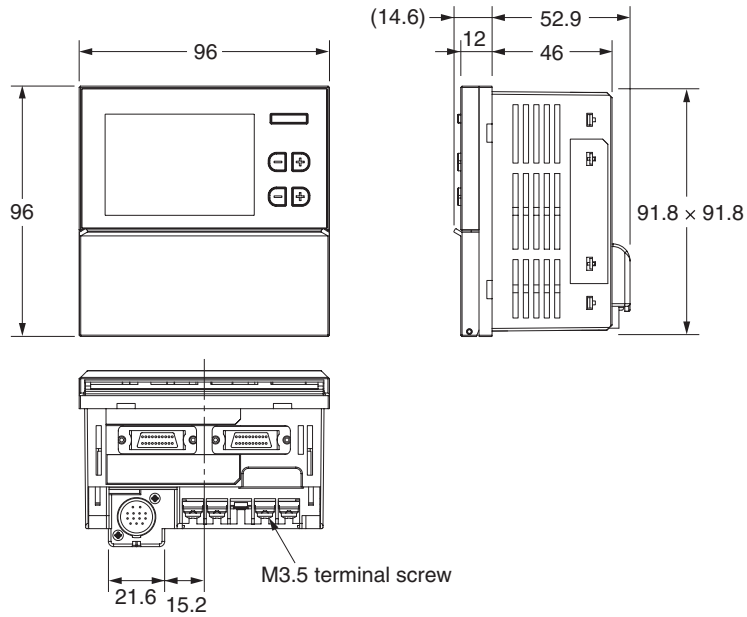

■ Surface Mounting H8PS-16□F□/32□F□ (16-/32-output models)

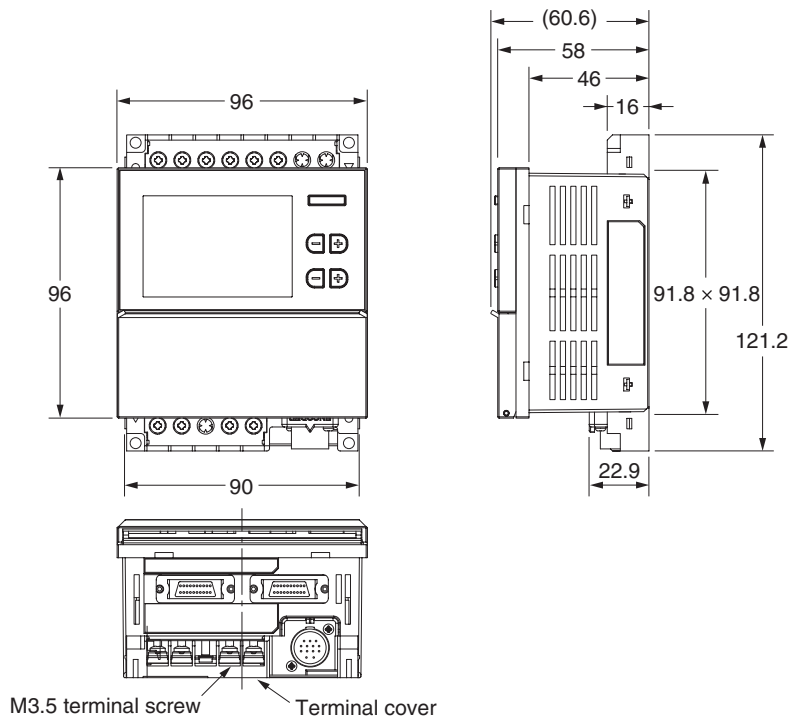

2.2.2 Mounting Method

■ Mounting on the Panel (for all flush mounting models)

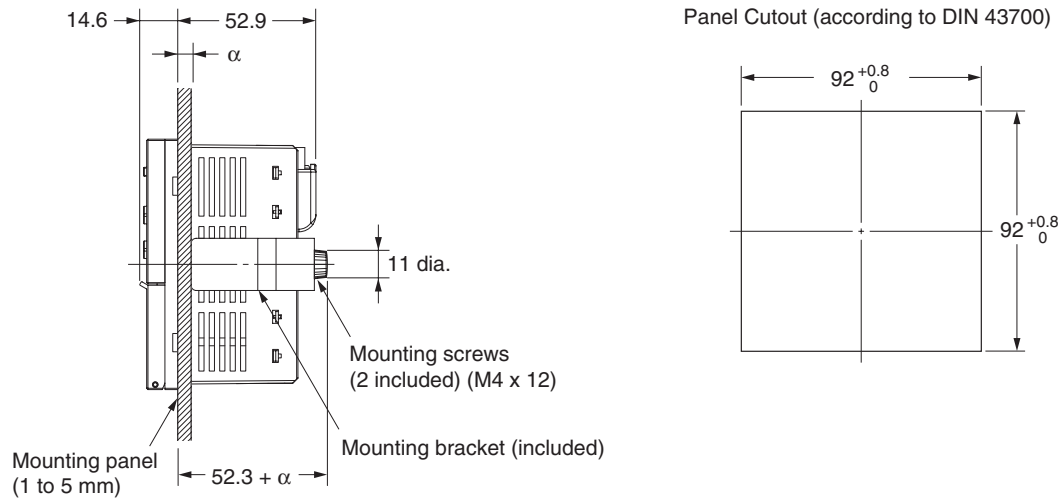

- Mounting panel thickness should be 1 to 5 mm.
- The illustration shows an 8-output model. With 16-/32-output models, the encoder cable is connected at the bottom of the cam positioner unit.

■ Options for Panel Mounting (sold separately)

● Protective Cover

Y92A-96B

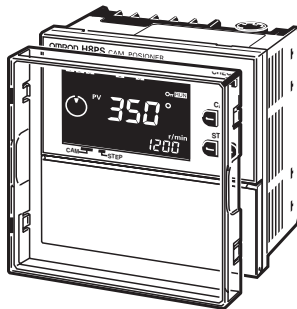

A hardened Y92A-96B Protective Cover is available.
Use it for the following:

- To protect the front panel from dust and dirt.
- To prevent the set value from being altered due to accidental contact with the keys or switches.

● Waterproof Cover

Y92A-96N

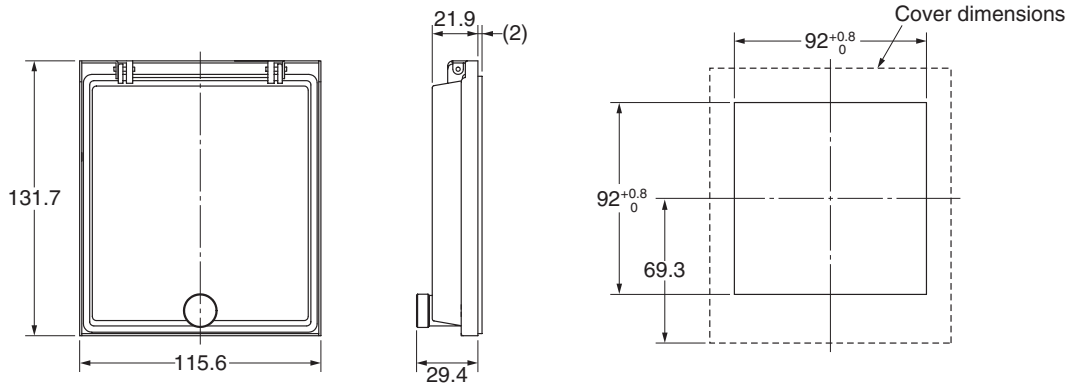
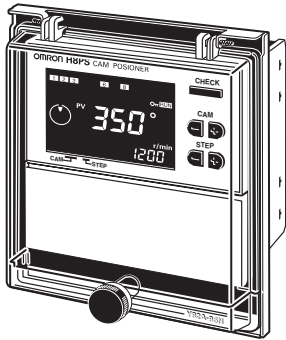

Use for flush mounting when waterproofing is required.

The Y92A-96N conforms to IP66 and NEMA4 (for indoor use) standards for waterproofing.

The operating environment may cause the waterproof packing to deteriorate, shrink, or harden.

Therefore, it is recommended that the packing be replaced regularly.

■ Surface Mounting (for all surface-mounting models)

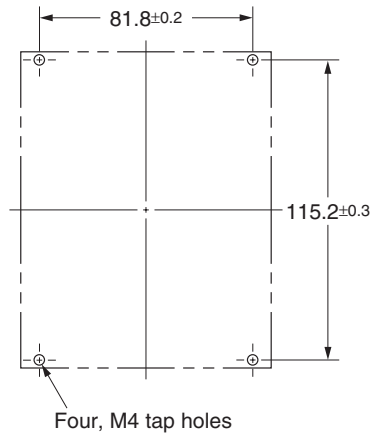

Surface Mounting

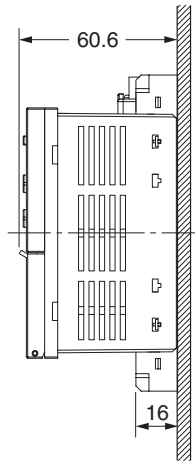

Track Mounting

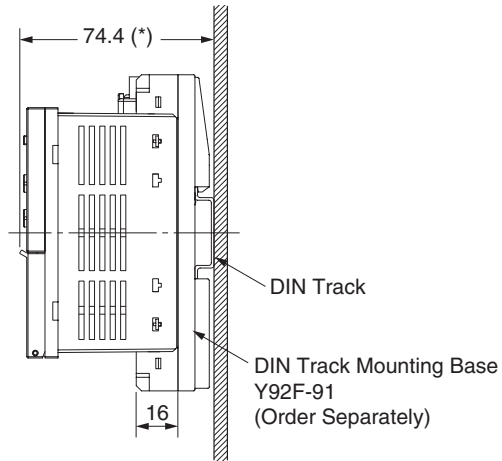

* This dimension (*) differs depending on the DIN track type (74.4 is only for reference).

The illustration shows an 8-output model. With 16-/32-output models, the encoder cable is connected at the bottom of the cam positioner unit.

■ DIN Track Mounting Options (sold separately)

● DIN Track Mounting Base

Y92F-91

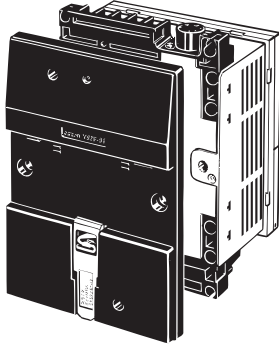

● Mounting Track

PFP-100N
PFP-50N

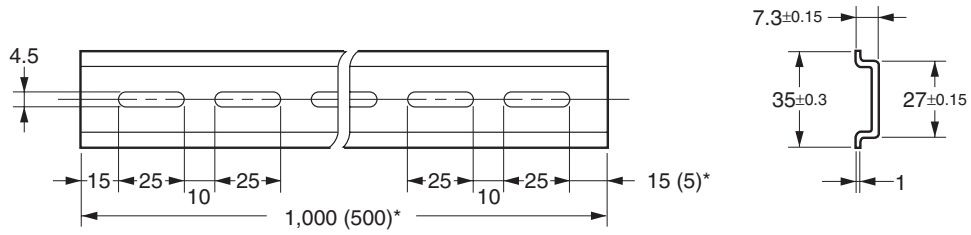
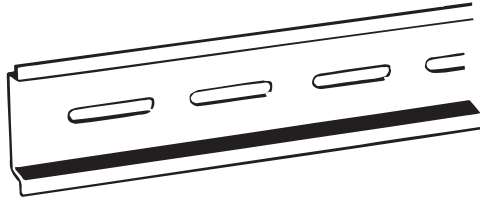

* Dimensions in parentheses () are for PFP-50N.

PFP-100N2

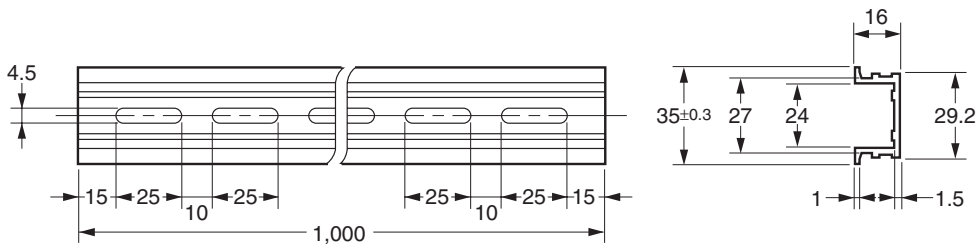
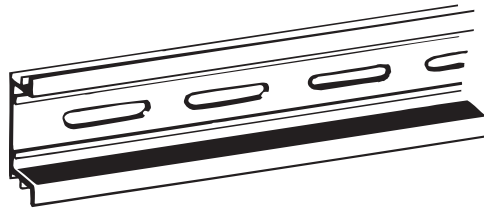

● End Plate

PFP-M

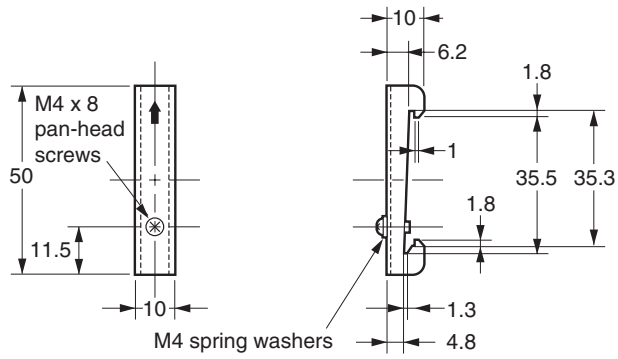
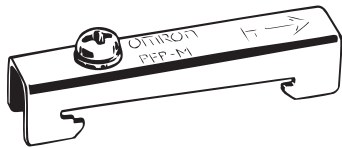

● Spacer

PFP-S

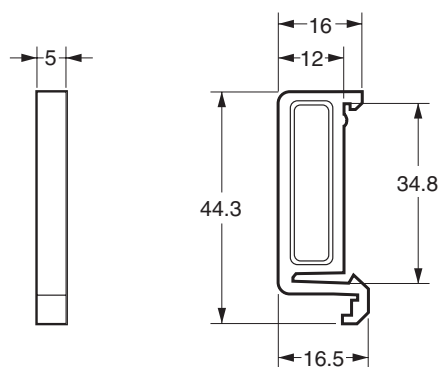
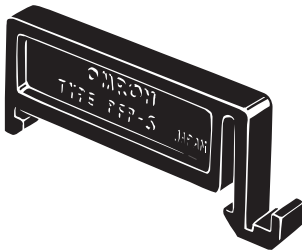

2.2.3 Encoder Connecting Direction

H8PS-8B□

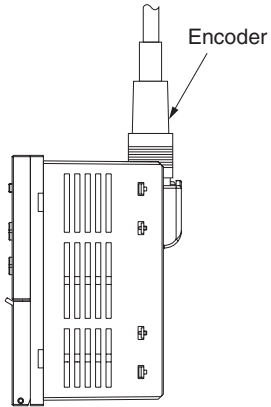

H8PS-8BF□

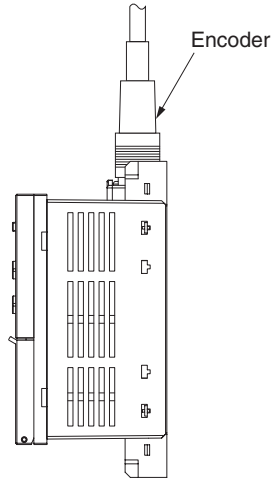

H8PS-16B□
H8PS-32B□

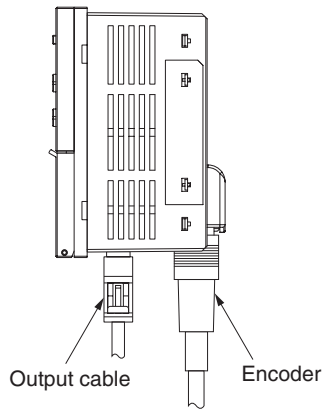

H8PS-16BF□
H8PS-32BF□

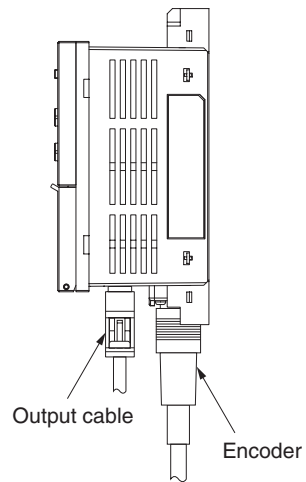

2.3 Mounting (Encoder)

Refer to the relevant datasheet for details.

2.3.1 Dimensions and Mounting Method

■ E6CP-AG5C-C



• Dimensions

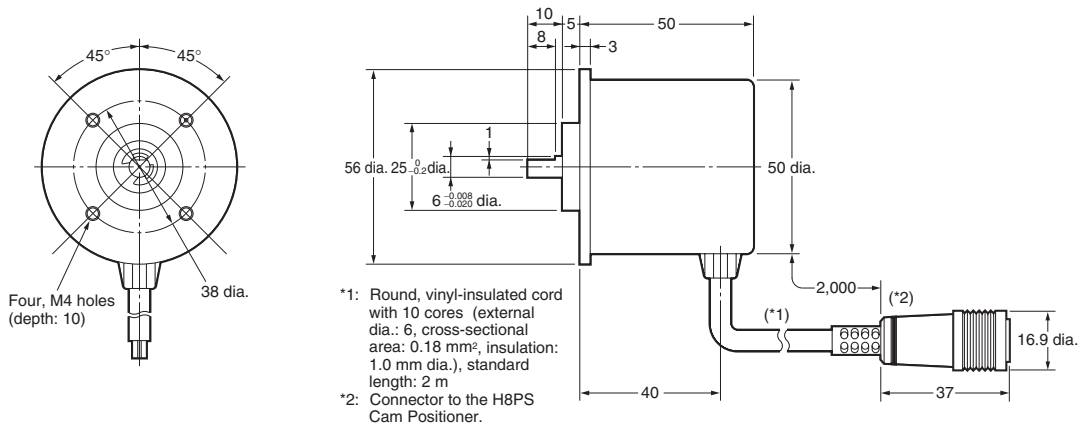

• Bracket Mounting Diagram

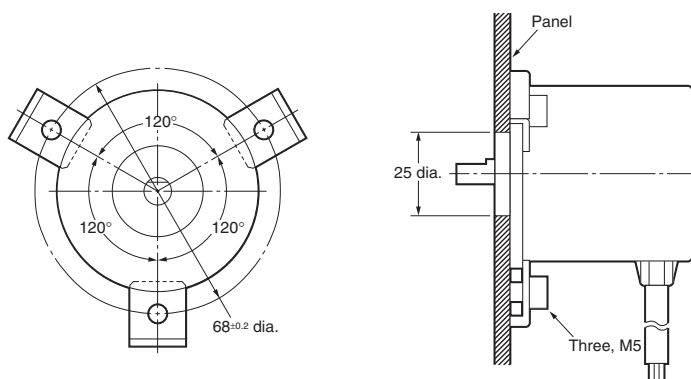

• Accessory Mounting Bracket (Included)

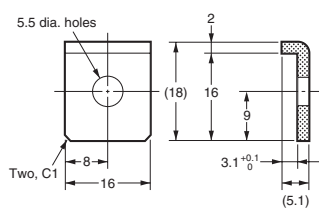

■ E6C3-AG5C-C



• Dimensions

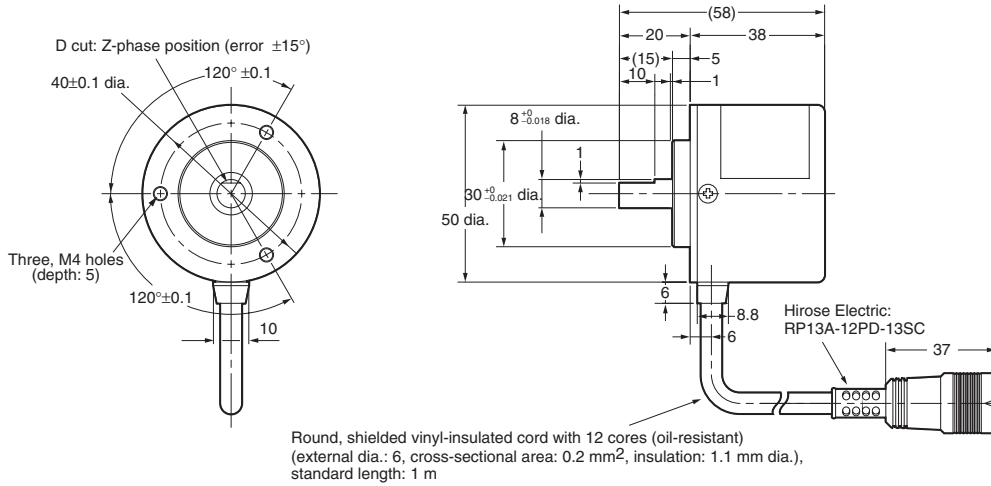

* Order coupling E69-C08B separately.

■ E6F-AG5C-C

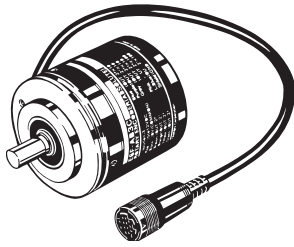

• Dimensions

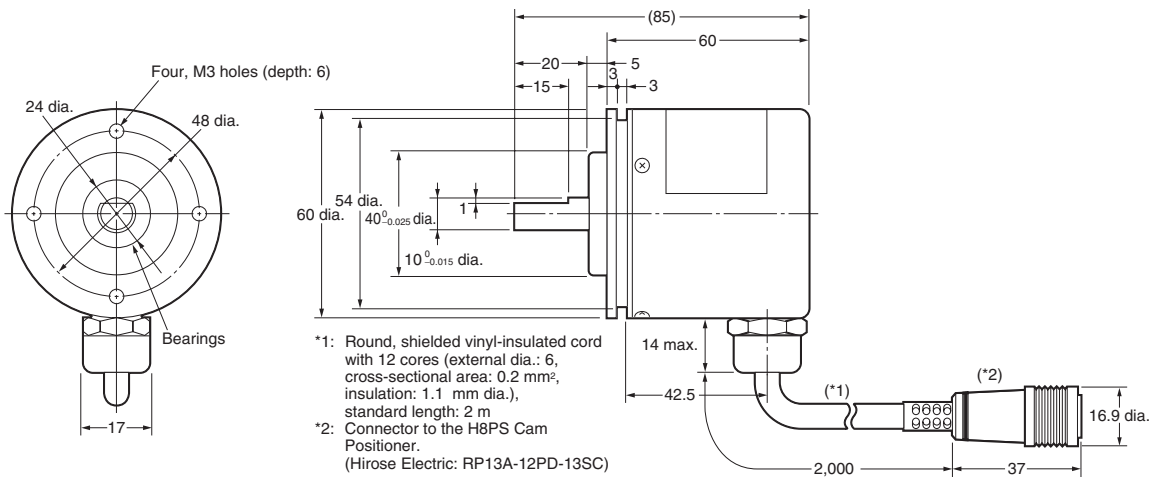

• Bracket Mounting Diagram

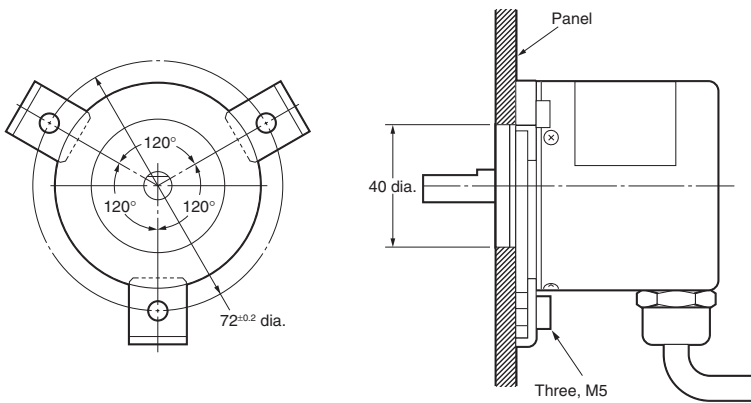

• Accessory
Mounting Bracket (Included)

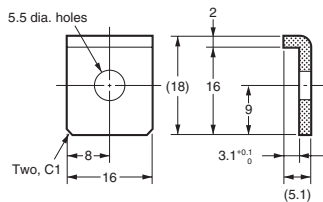

2.3.2 Accessories (Order Separately)

■ Shaft Coupling

- Shaft coupling E69-C06B (for E6CP)

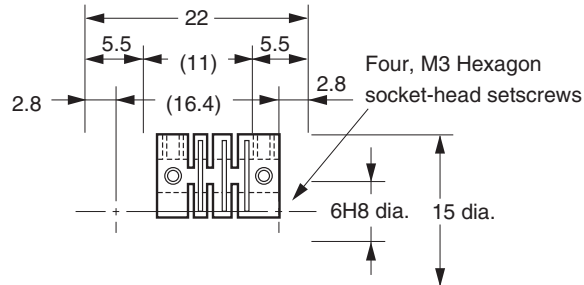

Material: Glass fiber reinforced polybutylene terephthalate resin (PBT)

- Shaft coupling E69-C08B (for E6C3)

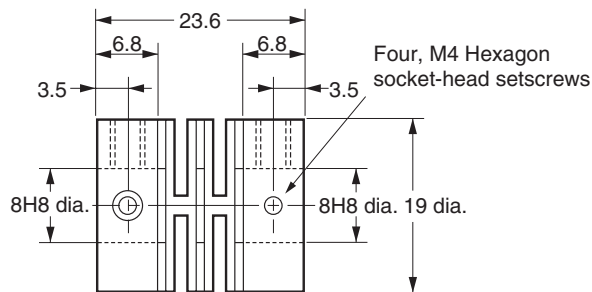

Material: Glass fiber reinforced polybutylene terephthalate resin (PBT)

- Shaft coupling E69-C10B (for E6F)

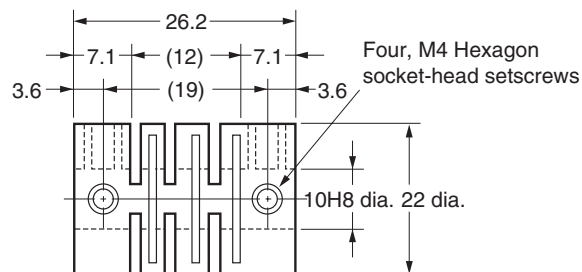

Material: Glass fiber reinforced polybutylene terephthalate resin (PBT)

■ Extension Cable

● E69-DF5 extension cable

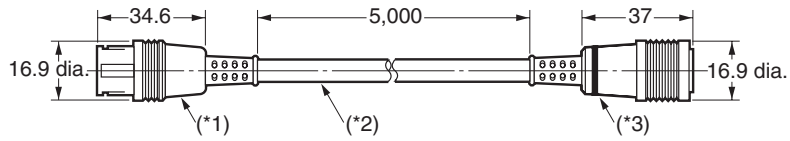
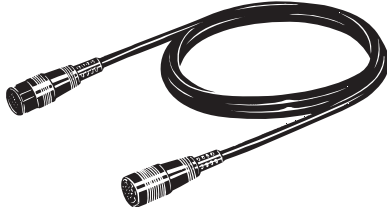

*1: E6F-AG5C-C, E6CP-AG5C-C, and E6C3-AG5C-C Connectors for the H8PS.

*2: 6-dia., 12-core shielded cord (cross-sectional area: 0.2 mm^2 , insulation: 1.1 mm dia.), standard length: 5 m

*3: Connected to the H8PS Cam Positioner.

2.3.3 Safety Precautions (Encoder)

■ Precautions for Correct Use

- Do not subject the E6CP Encoder to oil or water.
- The Encoder consists of high-precision components. Handle it with utmost care and do not drop it, otherwise malfunctioning may result.
- When connecting the shaft of the Encoder with a chain timing belt or gear, connect the chain timing belt or gear with the shaft via a bearing or coupling as shown in the following diagram.

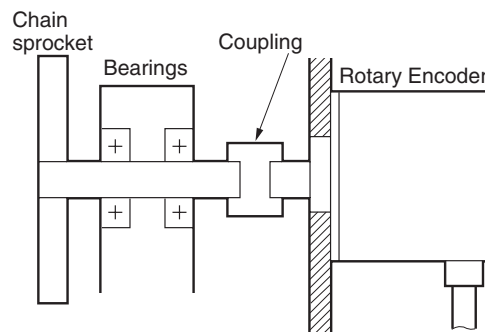

- If the decentering or declination value exceeds the tolerance, an excessive load imposed on the shaft may damage or shorten the life of the Encoder.
- Do not place excessive loads on the shaft if the shaft is connected to a gear.
- The tightening torque must not exceed the value given in the table at the right when the Rotary Encoder is mounted with screws.
- Do not pull wires with a force greater than 29.4 N while the Rotary Encoder is secured and wired.

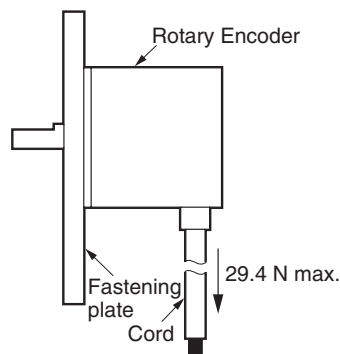

- Do not subject the shaft to shock. Therefore, do not strike the shaft or coupling with a hammer when inserting the shaft into the coupling.
- Make sure there is no foreign matter in the Connector before connecting it to the Encoder.

● Mounting Procedure

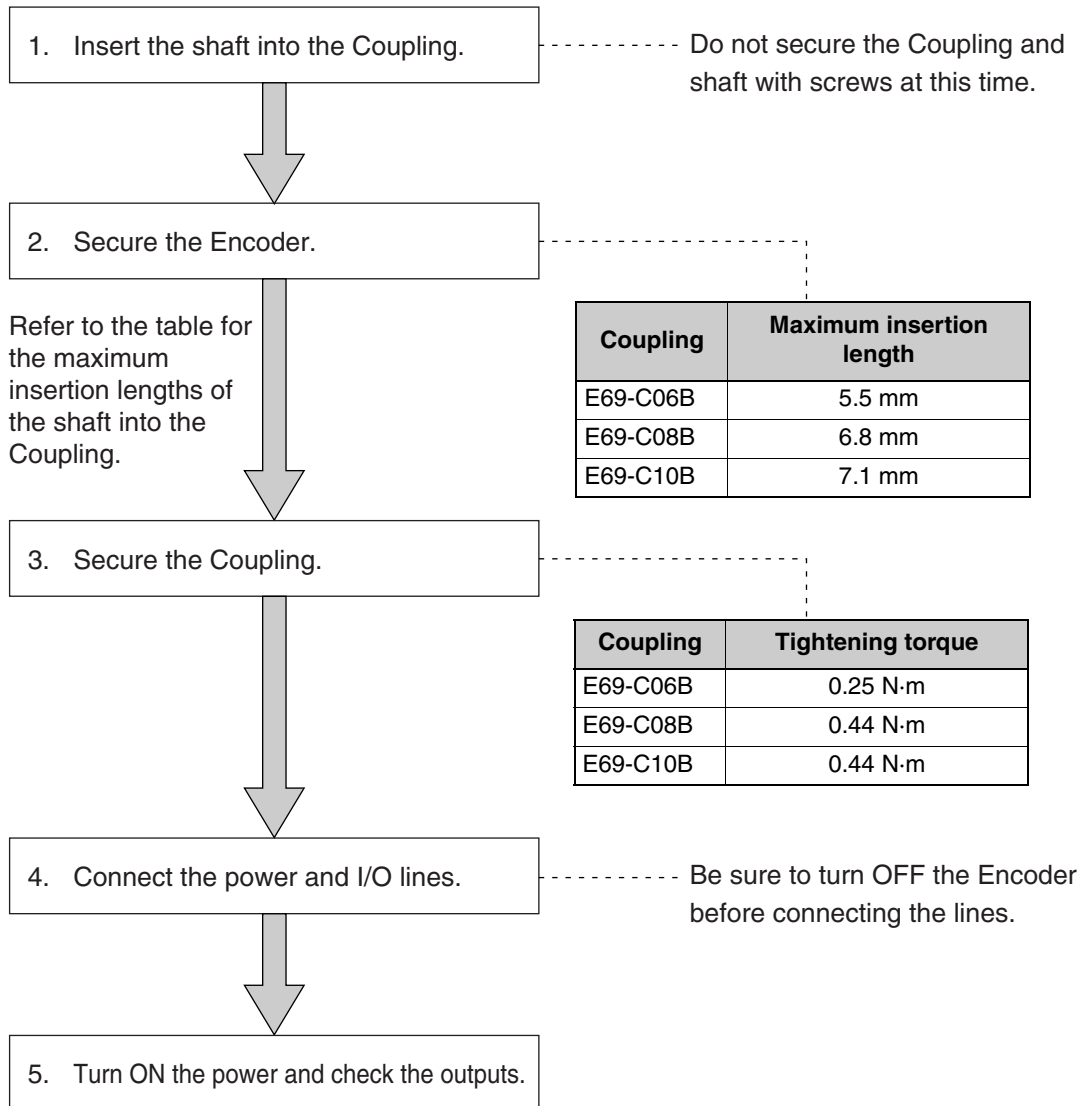

2.3.4 Parallel Input Adapters (Order Separately)

■ Y92C-30

This Adapter enables two H8PS Cam Positioners to share signals from an Encoder.

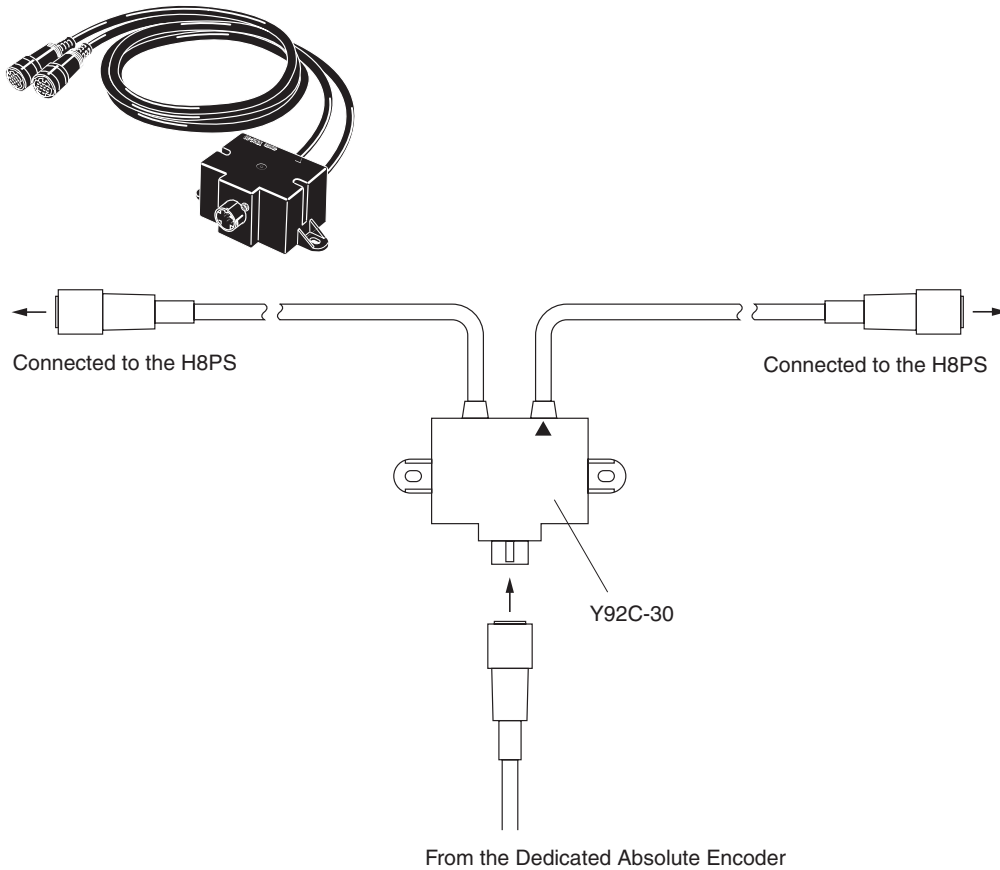

When connecting only one Positioner to the Parallel Operation Adapter, connect the cable with the ▲ mark.

■ Precautions for Correct Use

Starting in April 2004, H8PS Cam Positioners have been functionally improved to support high-resolution encoders as given below.

Previous H8PS Cam Positioners: The encoder input resolution was 256.

New H8PS Cam Positioners: The encoder input resolution can be 256, 360, or 720.

You cannot use the previous and new Cam Positioners together with a Y92C-30 Parallel Input Adapter for parallel operation. If you perform parallel operation, do not combine different types of H8PS Cam Positioners.

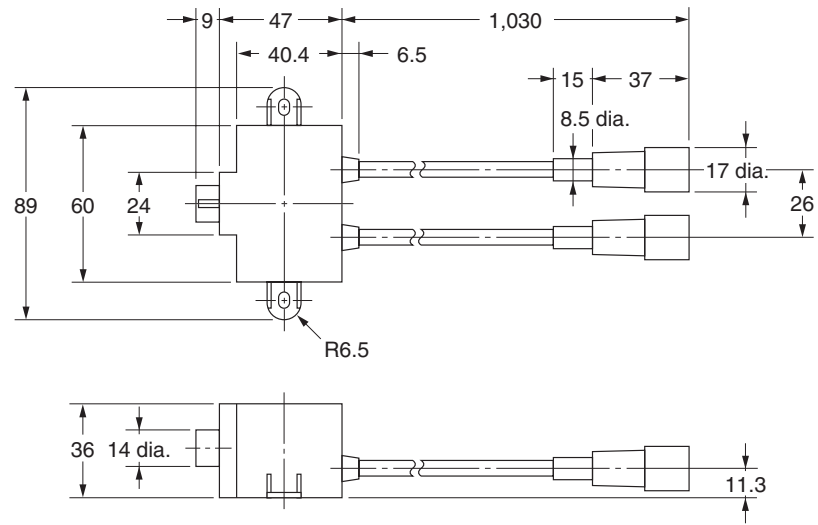

• Panel Surface Mounting

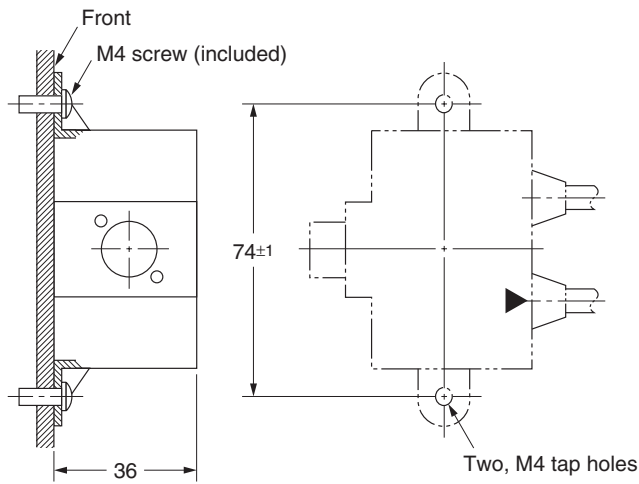

• Panel Back Mounting

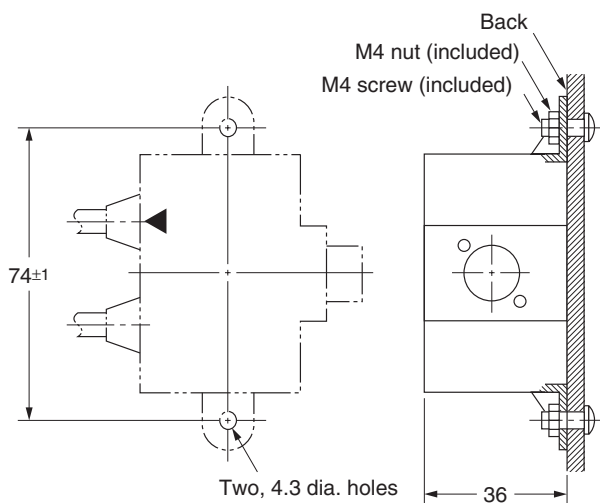

2.4 Wiring

2.4.1 System Connection Diagram

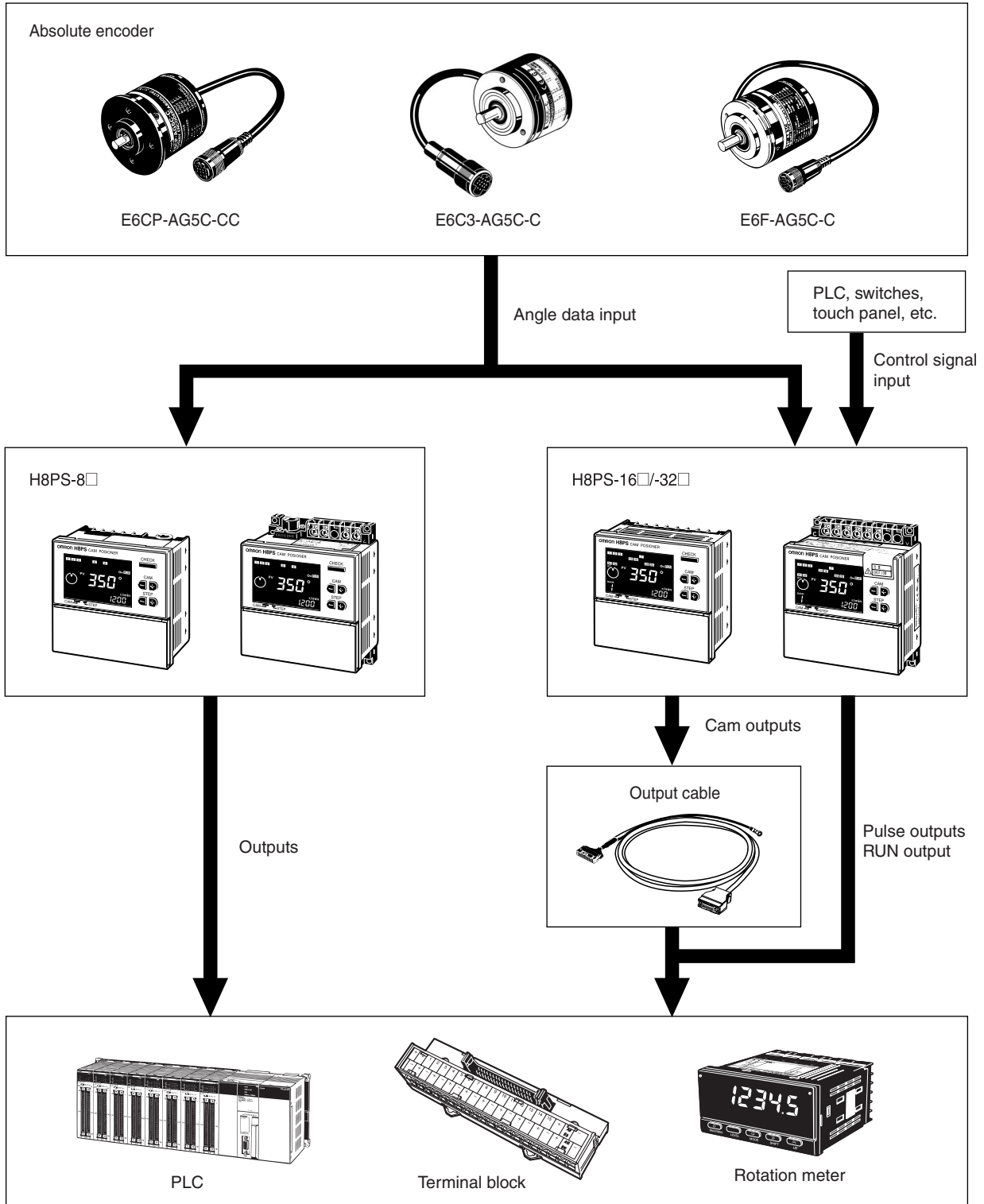

2.4.2 Terminal Arrangement

H8PS-8□ (8-output Models)	H8PS-16□/-32□ (16-/32-output Models)
<p>NPN Output, Flush Mounting H8PS-8□</p> <p>(Rear view)</p>	<p>NPN Output, Flush Mounting H8PS-16□/-32□</p> <p>(Rear view)</p>
<p>NPN Output, Surface Mounting H8PS-8□F</p> <p>(Front view)</p>	<p>NPN Output, Surface Mounting H8PS-16□F/-32□F</p> <p>(Front view)</p>
<p>PNP Output, Flush Mounting H8PS-8□P</p> <p>(Rear view)</p>	<p>PNP Output, Flush Mounting H8PS-16□P/-32□P</p> <p>(Rear view)</p>
<p>PNP Output, Surface Mounting H8PS-8□FP</p> <p>(Front view)</p>	<p>PNP Output, Surface Mounting H8PS-16□FP/-32□FP</p> <p>(Front view)</p>

Output Cable Connections (16-/32-output Models Only)

Flush Mounting Models

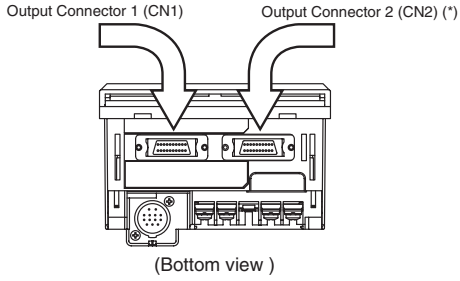

Surface Mounting Models

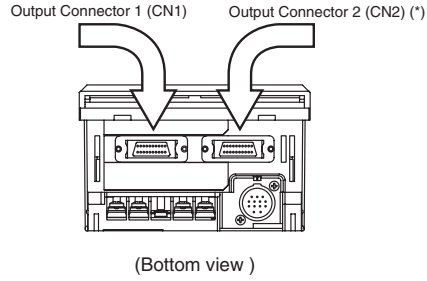

Output connector	Output signal
Output connector (CN1)	Cam 1 to Cam 16, COM and Vs
Output connector (CN2)*	Cam 17 to Cam 32, COM and Vs

* 16-output models do not have CN2 connector.

● E5ZE-CBL200 Connector-type Output Cable (Order Separately) Connections

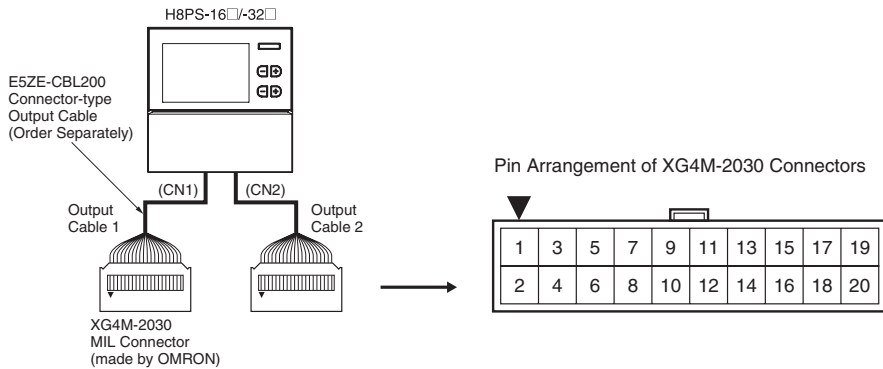

Wiring table - Output cable 1

Output	Connector pin No.	Output	Connector pin No.
Cam 1	20	Cam 9	19
Cam 2	18	Cam 10	17
Cam 3	16	Cam 11	15
Cam 4	14	Cam 12	13
Cam 5	12	Cam 13	11
Cam 6	10	Cam 14	9
Cam 7	8	Cam 15	7
Cam 8	6	Cam 16	5
COM	4	COM	3
Vs	2	Vs	1

Wiring table - Output cable 2

Output	Connector pin No.	Output	Connector pin No.
Cam 17	20	Cam 25	19
Cam 18	18	Cam 26	17
Cam 19	16	Cam 27	15
Cam 20	14	Cam 28	13
Cam 21	12	Cam 29	11
Cam 22	10	Cam 30	9
Cam 23	8	Cam 31	7
Cam 24	6	Cam 32	5
COM	4	COM	3
Vs	2	Vs	1

Note 1. The COM signal on the output connector is connected to the minus terminal of the 24-VDC power input inside the Cam Positioner.

Note 2. The Vs signal on the output connector is connected to Vs terminal inside the Cam Positioner.

Note 3. For an NPN output, the Vs signal on the output connector is not used.

Note 4. The COM signals on output connectors 1 and 2 are connected inside the Cam Positioner. Also, the Vs signals are connected inside the Cam Positioner.

- Using Connector-Terminal Block Conversion Units

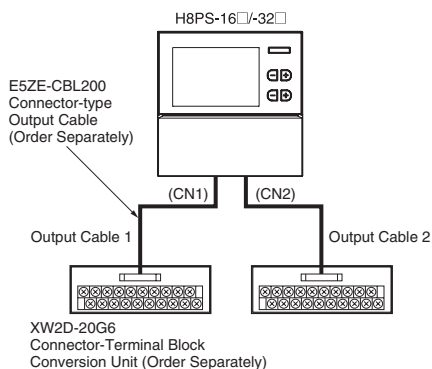

Terminal Arrangement of the XW2D-20G6 Connector-Terminal Block Conversion Unit

Output Cable 1

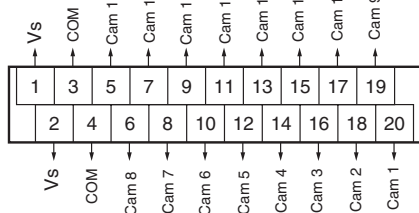

Output Cable 2

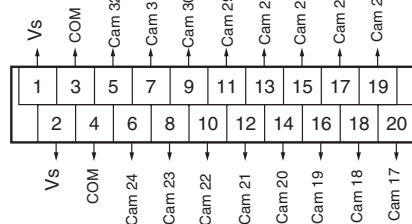

● Y92S-41-200 Discrete Wire Output Cable (Order Separately) Connections

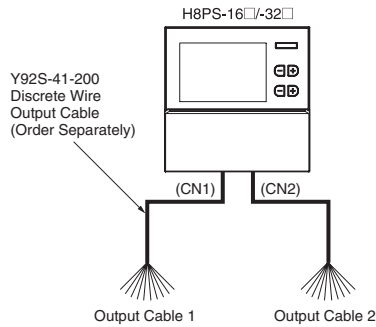

Output Cable 1 Wiring Table

Outputs	Cable color	Marks	Marking color	Outputs	Cable color	Marks	Marking color
Cam 1	Orange	■	Black	Cam 9	Orange	■	Red
Cam 2	Gray	■	Black	Cam 10	Gray	■	Red
Cam 3	White	■	Black	Cam 11	White	■	Red
Cam 4	Yellow	■	Black	Cam 12	Yellow	■	Red
Cam 5	Pink	■	Black	Cam 13	Pink	■	Red
Cam 6	Orange	■ ■	Black	Cam 14	Orange	■ ■	Red
Cam 7	Gray	■ ■	Black	Cam 15	Gray	■ ■	Red
Cam 8	White	■ ■	Black	Cam 16	White	■ ■	Red
COM	Yellow	■ ■	Black	COM	Yellow	■ ■	Red
Vs	Pink	■ ■	Black	Vs	Pink	■ ■	Red

Output Cable 2 Wiring Table

Outputs	Cable color	Marks	Marking color	Outputs	Cable color	Marks	Marking color
Cam 17	Orange	■	Black	Cam 25	Orange	■	Red
Cam 18	Gray	■	Black	Cam 26	Gray	■	Red
Cam 19	White	■	Black	Cam 27	White	■	Red
Cam 20	Yellow	■	Black	Cam 28	Yellow	■	Red
Cam 21	Pink	■	Black	Cam 29	Pink	■	Red
Cam 22	Orange	■ ■	Black	Cam 30	Orange	■ ■	Red
Cam 23	Gray	■ ■	Black	Cam 31	Gray	■ ■	Red
Cam 24	White	■ ■	Black	Cam 32	White	■ ■	Red
COM	Yellow	■ ■	Black	COM	Yellow	■ ■	Red
Vs	Pink	■ ■	Black	Vs	Pink	■ ■	Red

2.4.3 Input Connections

Only the Encoder inputs are connected with 8-output Models.

For 16-/32-point models, the inputs are no-voltage (short-circuit or open) inputs.

■ No-voltage Inputs

<Open Collector>

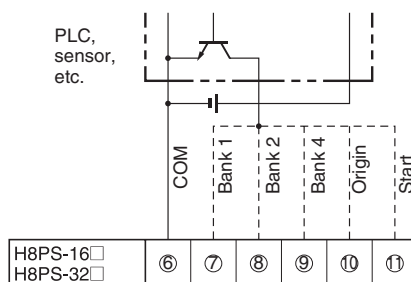

Note: Operates when the transistor turns ON.

<Contact Input>

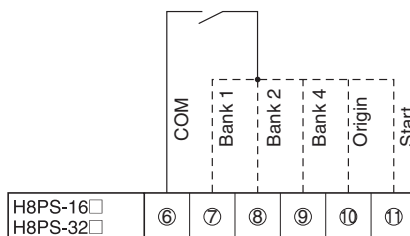

Note: Operates when the contact turns ON.

Voltage-output sensors can also be connected.

<Connection Examples>

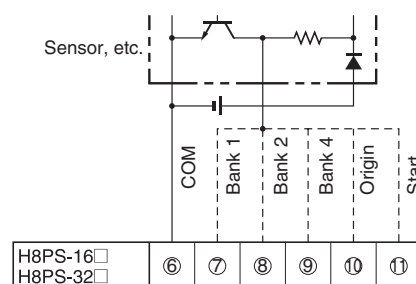

Note: Operates when the transistor turns ON.

- No-voltage Input Signal Levels

No-contact inputs	Short-circuit level for transistor ON
	<ul style="list-style-type: none"> • Residual voltage: 2 V max. • Impedance when ON: 1 kΩ max. (The leakage current is approx. 2 mA when the impedance is 0 Ω.)
Contact inputs	Open level for transistor OFF
	<ul style="list-style-type: none"> • Impedance when OFF: 100 kΩ min.
	Use a contact that can adequately switch 2 mA at 5 V.

* Use a maximum DC power supply of 30 V.

2.4.4 Output Connections

Internal circuit damage may result from a short circuit in the load.

■ NPN Output Models

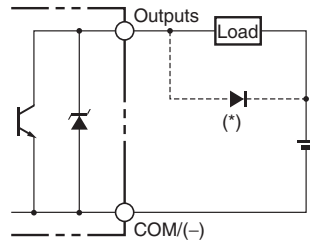

* Always connect a diode to absorb counter-electromotive force when connecting an inductive load.

Item	Cam outputs, RUN output	Pulse output
Output method	NPN open collector	
Dielectric strength	30 VDC	
Rated current	100 mA (See note.)	30 mA
Residual voltage	2 VDC max.	0.5 VDC max.
Leakage current	100 μ A max.	5 μ A max.

* Do not exceed 1.6 A total for all cam outputs and the RUN output.

■ PNP Output Models

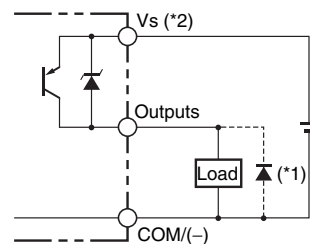

*1 Always connect a diode to absorb counter-electromotive force when connecting an inductive load.
 *2 The Vs terminal and power supply terminals are not connected.

Item	Cam outputs, RUN output	Pulse output
Output method	PNP open collector	
Dielectric strength	8-output Models: 30 VDC 16-/32-output Models: 26.4 VDC	
Rated current	100 mA (*)	30 mA
Residual voltage	2 VDC max.	
Leakage current	100 μ A max.	

* Do not exceed 1.6 A total for all cam outputs and the RUN output.

Section 3 HOW TO USE THE BASIC FUNCTIONS

The H8PS Cam Positioners can be operated easily by simply following the operational steps described in this section.

3.1	Operation Basics	3-2
3.2	Preparatory Steps before Starting Operation	3-4
3.3	DIP Switch Setting	3-5
3.4	Setting the Origin	3-7
3.5	Setting the ON/OFF Angles	3-8
3.6	Checking the Operation Timing	3-12
3.7	Operation	3-13
3.8	Clearing the Settings	3-15
3.9	Checking the Settings in the Run Mode	3-18
3.10	Switching the Display between Speed and Angle	3-19
3.11	All Protection Function.....	3-20

3.1 Operation Basics

The basics of the operation of the H8PS Cam Positioner are explained below.
 For more details on operation, refer to "4.1 Mode Transitions".

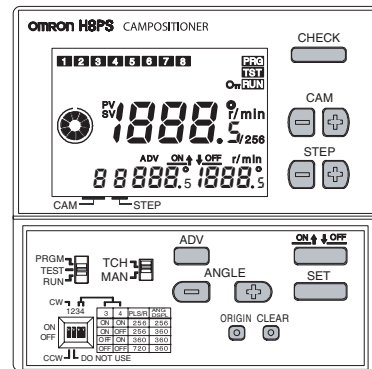
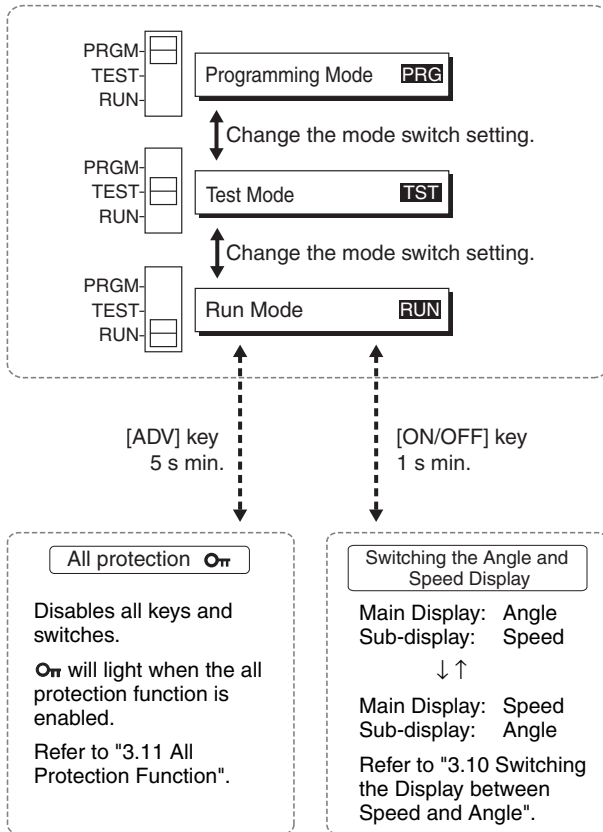

HOW TO USE THE BASIC FUNCTIONS

● Operation Modes and Functions

Operation mode	Display	Outline	Main functions
Programming Mode	[PRG] lights.	In this mode, programming and setting, e.g. writing cam programs and setting the advance angle compensation (ADV) function, are performed. No outputs will be given in this mode.	<ul style="list-style-type: none"> • Writing cam programs (manual/teach) • Clearing cam programs • All clear • Setting the origin • Setting the advance angle compensation (ADV) function • Switching to the function setting mode
Test Mode	[TST] lights.	In this mode, programming and setting, e.g. writing cam programs and setting the advance angle compensation (ADV) function, are performed while confirming the outputs. This mode should also be selected for making adjustments such as changing the settings while running the Cam Positioner.	<ul style="list-style-type: none"> • Writing cam programs (manual/teach) • Clearing cam programs • All clear • Setting the origin • Setting the advance angle compensation (ADV) function
Run Mode	[RUN] lights.	In this mode, normal operation is performed. Programming and setting operations such as writing cam programs and setting the advance angle compensation (ADV) function are not possible.	<ul style="list-style-type: none"> • Checking cam programs • Switching the display between Speed and Angle • All protection

* The items in ***italic*** are explained in "4 HOW TO USE THE ADVANCED FUNCTIONS".

3.2 Preparatory Steps before Starting Operation

The steps to be followed before starting the operation of the H8PS Cam Positioner are explained below.

(The steps described below are a series of preparatory steps before starting H8PS Cam Positioner operation under the default settings.)

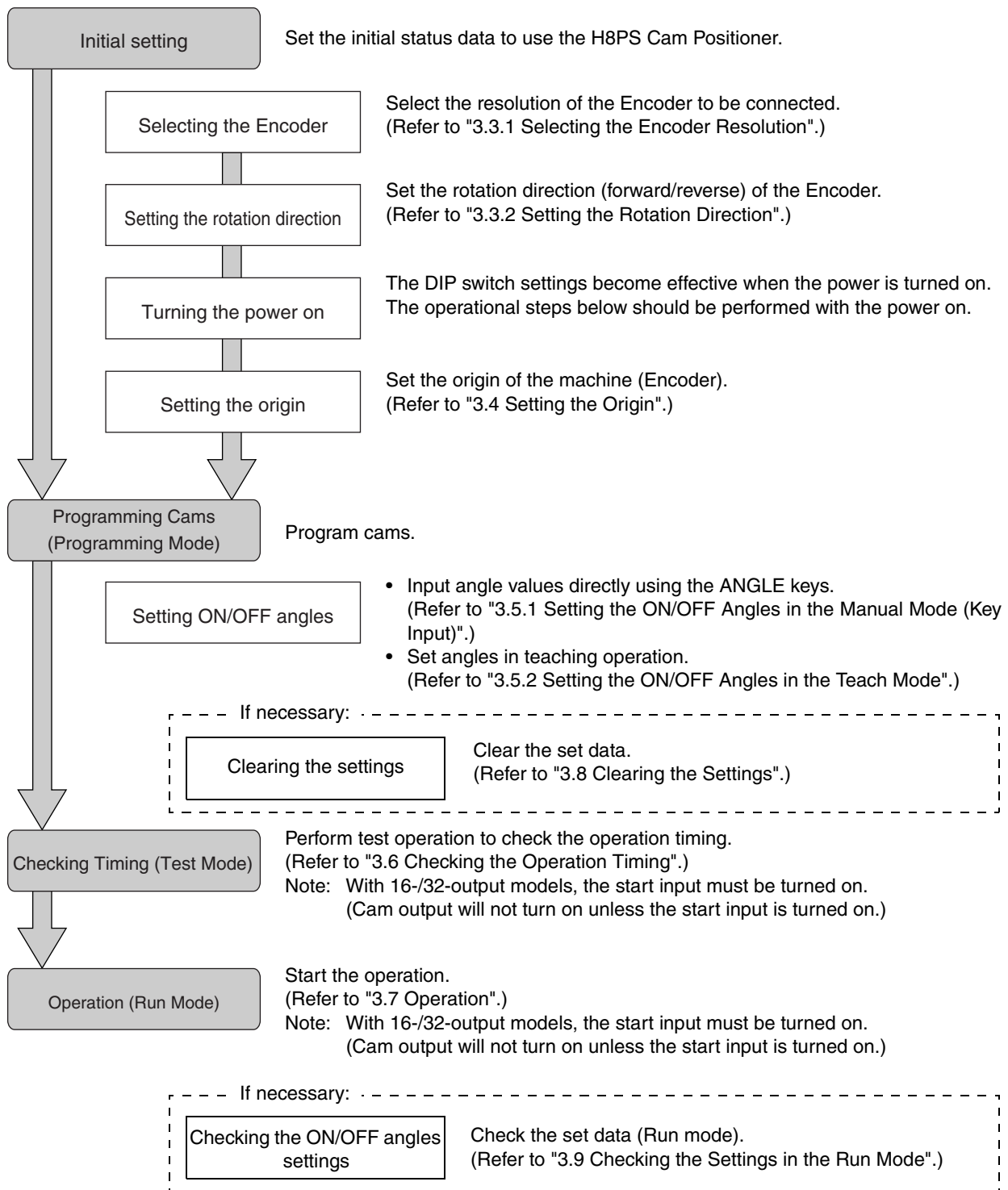

3.3 DIP Switch Setting

3.3.1 Selecting the Encoder Resolution

The Encoder to be connected to the H8PS Cam Positioner can be chosen from among three resolutions (256/360/720).

In this step the resolution and display angle are designated.

■ Operation

Make sure that the power is off.

Open the front cover at the lower part of the H8PS and set pins 3 and 4 on the DIP switch.

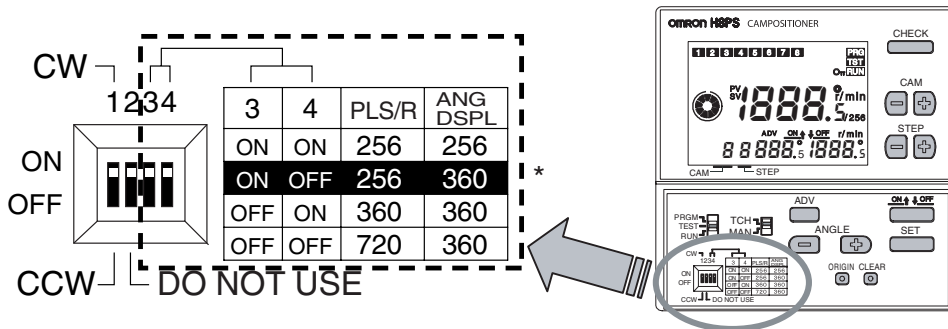

* The factory setting is indicated by white characters on a black background.

If an Encoder with a resolution of 256 per rotation is used, angles cannot be displayed using 360° notation if the Encoder outputs are used as they are. To facilitate operation, the H8PS Cam Positioner has a function for displaying/setting the angles using 360° notation even if a 256 resolution Encoder is connected. With this type of Encoder, however, there are angles that cannot be displayed if 360° notation display is selected.

Hint

- When operating the DIP switch, use a tip of tweezers or a tool with a tip approximately 0.8 mm in width.
- The DIP switch settings are read to the H8PS Cam Positioner when the power is turned on.
- When the resolution selection is changed and read, all types of information including all the programs, the data set in the function setting mode, and the origin information are cleared (initialized). This does not happen if just the display angle setting is changed on a 256 resolution Encoder.
- If the all protection function is active (Refer to "3.11 All Protection Function"), changing the settings is not allowed and any attempt to do so is disregarded.
- Pin 2 on the DIP switch is not used and must remain in the factory setting.

3.3.2 Setting the Rotation Direction

Set the rotation direction of the machine (Encoder).

■ Checking the Rotation Direction

Turn the machine (Encoder) in the direction of actual operation and confirm that the rotation display monitor shows clockwise rotation. (This can also be checked by observing the angle display values increase as the Encoder turns).



Monitoring is possible in the following modes:

- Run mode (unconditionally)
- Test mode (only in the teaching mode)

■ Operation

Make sure that the power is off.

Open the front cover at the lower part of the H8PS and set pin 1 on the DIP switch.

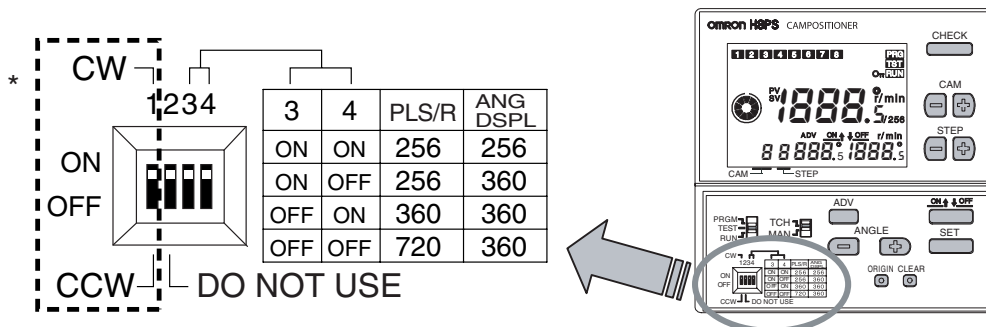

* Default setting.

Hint

- When operating the DIP switch, use a tip of tweezers or a tool with a tip approximately 0.8 mm in width.
- The DIP switch settings are read to the H8PS Cam Positioner when the power is turned on.
- If the all protection function is active (Refer to "3.11 All Protection Function"), changing the settings is not allowed and any attempt to do so is disregarded.
- Pin 2 on the DIP switch is not used and must remain in the factory setting.

3.4 Setting the Origin

This step (origin designation) is necessary to match the origin of the H8PS Cam Positioner with that of the machine (Encoder).

Origin designation is necessary when the system is introduced. It is also required in the cases indicated below.

- When an Absolute Encoder is replaced.
- When an H8PS Cam Positioner is replaced.
- When the Encoder resolution setting is changed by DIP switch setting.
- Adjustments that require the origin to be changed.

Hint

The origin information set by pressing the [ORIGIN] key is retained even if the power to the H8PS Cam Positioner is turned off. Note that the origin is common to all banks. (The bank function is available only with 16-/32-output models.)

■ Operation

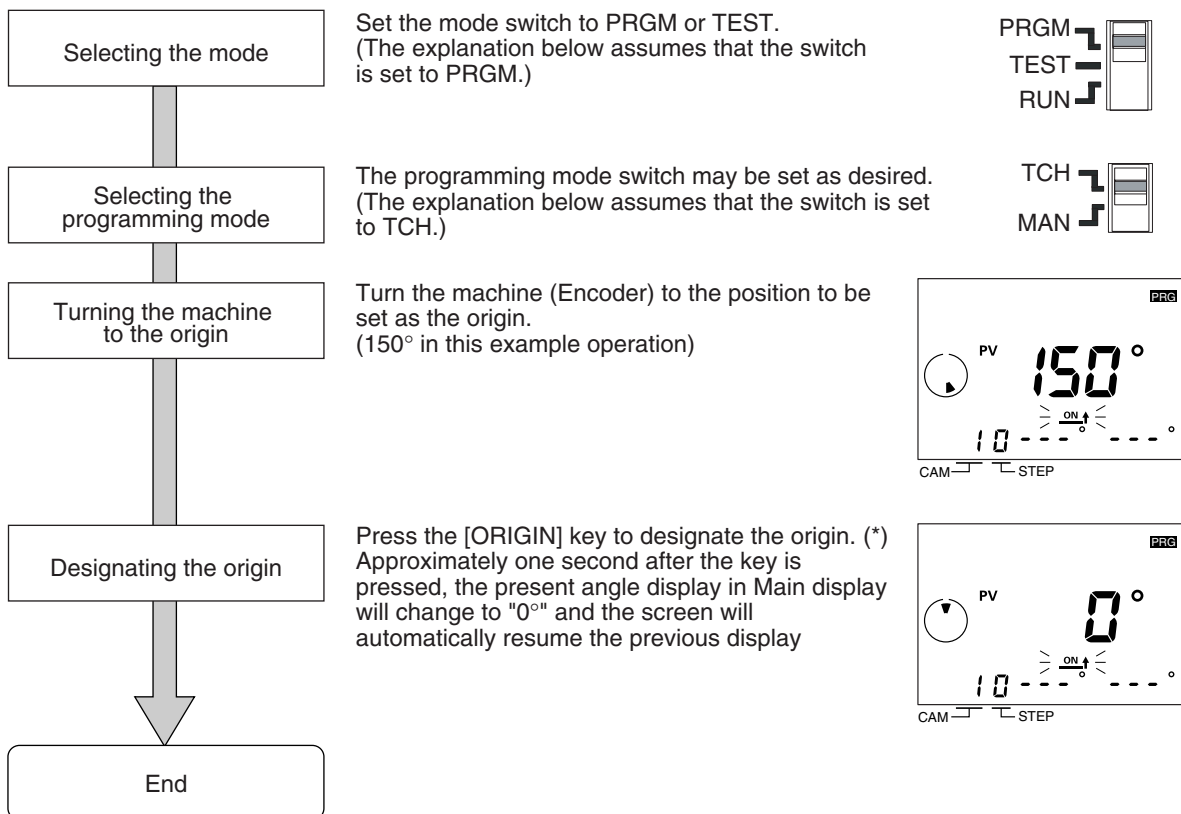

* With 16-/32-output models, the origin input from the terminal block can be turned ON to specify the origin.

3.5 Setting the ON/OFF Angles

● The number of programmable steps

ON/OFF angles may be set with up to 10 steps for each cam.

With a 32-output model, however, the total number of programmable steps is 160 for all cams and if an attempt is made to set ON/OFF angles exceeding this limit, "FULL" will appear, setting being disabled.

Hint

It is also possible to limit the number of programmable steps for each cam. (Refer to "4.6 Step Number Limit (F5)".)

● Programming

The two methods shown below are provided for setting ON/OFF angles and any of these may be used.

1. Manual mode setting using the keys (Refer to "3.5.1 Setting the ON/OFF Angles in the Manual Mode (Key Input)".)

In this method, the desired angle is set directly using the keys on the front of the Cam Positioner.

This setting can be done without connecting an Encoder.

2. Teaching mode setting (Refer to "3.5.2 Setting the ON/OFF Angles in the Teach Mode".)

In this method, the machine (Encoder) is actually turned and the desired angle is set by teaching operation.

Hint

For your convenience, use the coding sheet to write cam programs. (Refer to "Appendix A Specifications (Ratings)".)

The next pages explain the actual programming steps using the following ON/OFF chart as an example.

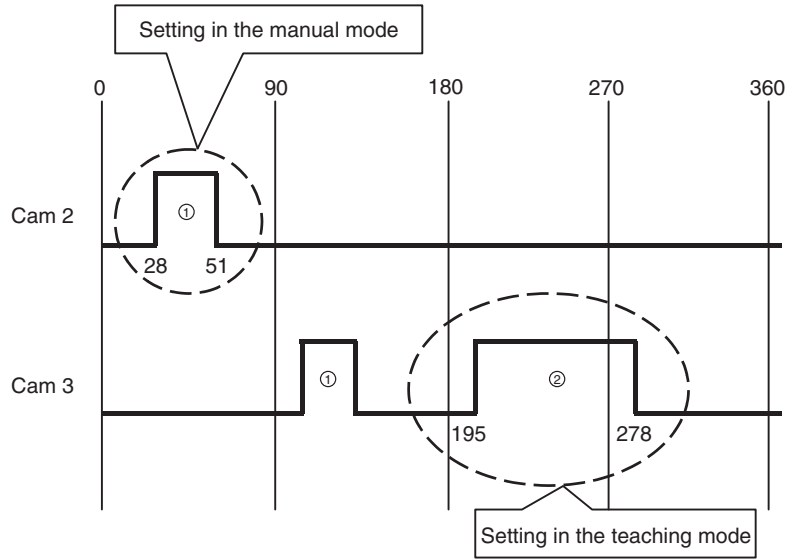

3.5.1 Setting the ON/OFF Angles in the Manual Mode (Key Input)

<Example>

To set "ON at 25° and OFF at 51°" for Cam 2, Step No. 1

Selecting the mode

Set the mode switch to PRGM or TEST.
(The explanation below assumes that the switch is set to PRGM.)



Selecting the programming mode

Set the programming mode switch to MAN.



Setting a bank number

When banks are used with 16-/32-output models

Set the bank number of the bank to be used.
For details on setting a bank function, refer to "4.8 Bank Function (F7/F8/F9)".

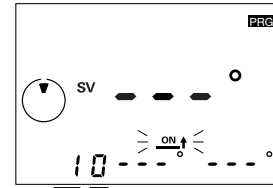

Designating the cam No./step No.

Press the [+] or [-] key of the CAM keys to change the cam number to "2".
Similarly, press the [+] or [-] key of the STEP keys to change the step number to "1."

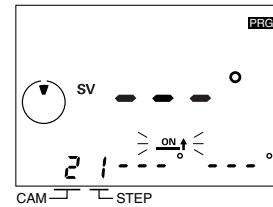

Setting the ON angle

Press the [ON↑ ↓OFF] key to select the ON angle setting state (ON↑ flashing).
Pressing the [+] or [-] key of the ANGLE keys to set the desired ON angle (28° in this example) and then press the [WRITE] key. (Make sure 28° appears in Sub-display.)

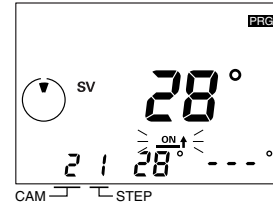

Setting the OFF angle

Press the [ON↑ ↓OFF] key to select the OFF angle setting state (↓OFF flashing).
Pressing the [+] or [-] key of the ANGLE keys to set the desired OFF angle (51° in this example) and then press the [WRITE] key. (Make sure 51° appears in Sub-display.)

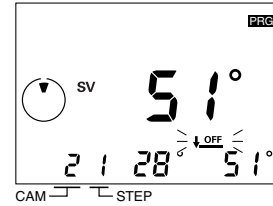

End

Hint

- The value being set using the CAM keys ([+] and [-]), STEP keys ([+], [-]) or ANGLE keys ([+], [-]) changes rapidly if the key is held down. In the case of the ANGLE keys, the value being set changes more rapidly when the other key is pressed.
- The setting procedure explained above may not be possible if the step-number limit function (Refer to "4.6 Step Number Limit (F5)"), the cam protection function (Refer to "4.7 Cam Protection (F6)") or the all protection function (Refer to "3.11 All Protection Function") is used.

3.5.2 Setting the ON/OFF Angles in the Teach Mode

<Example>

To set "ON at 195° and OFF at 278°" for Cam 3, Step No. 2

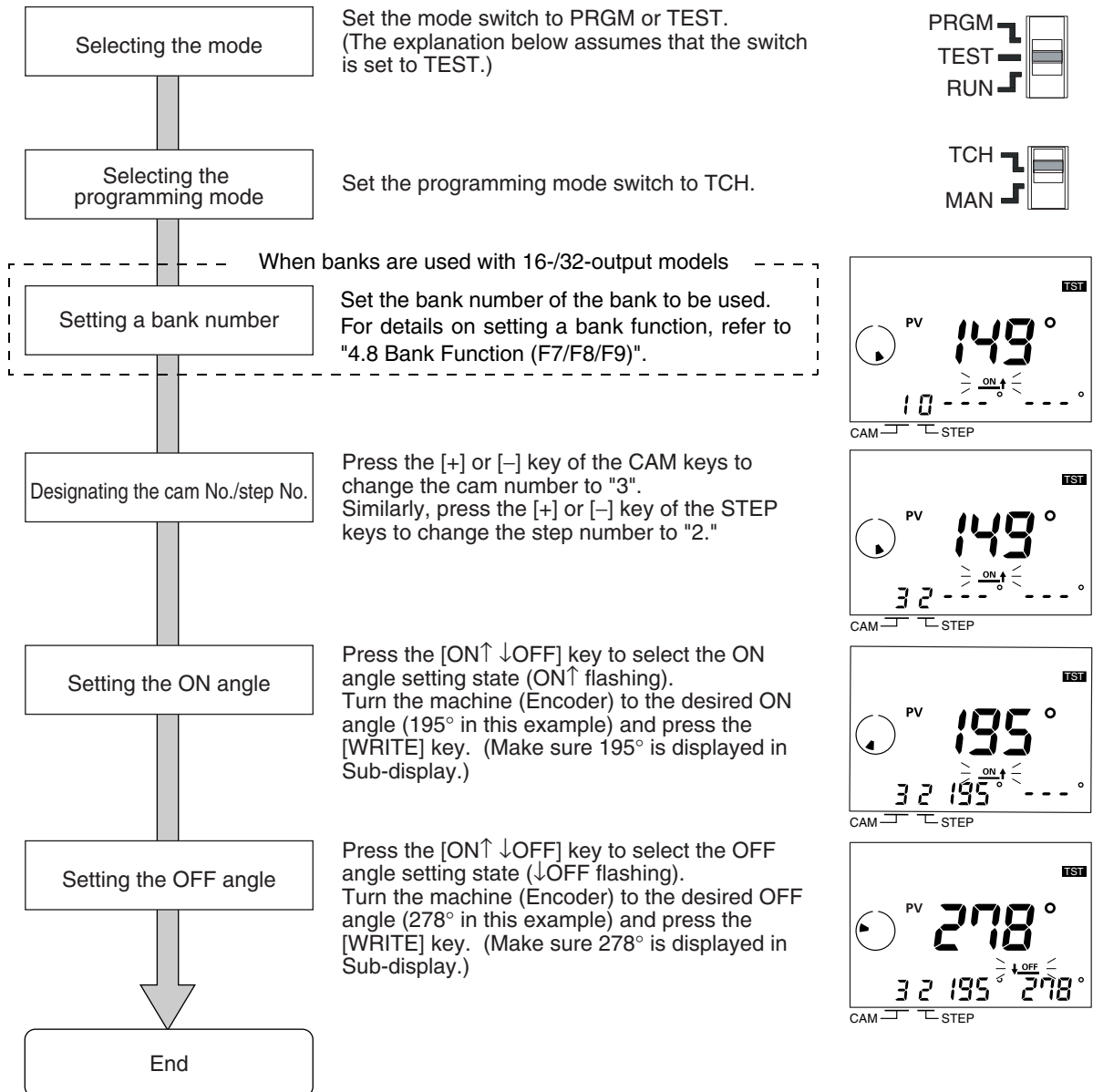

Hint

- The value being set using the CAM keys ([+] and [-]) or STEP keys ([+] and [-]) changes rapidly if the key is held down.
- The setting procedure explained above may not be possible if the step-number limit function (Refer to "4.6 Step Number Limit (F5)"), the cam protection function (Refer to "4.7 Cam Protection (F6)") or the all protection function (Refer to "3.11 All Protection Function") is used.

3.6 Checking the Operation Timing

Set the mode switch to TEST and check the ON/OFF angles while turning on the outputs.



Operating the machine (Encoder) to confirm the operation timing.

If it is not correct, change the set ON/OFF angles.

For the procedure to change the ON/OFF angles, refer to "3.5 Setting the ON/OFF Angles".

■ For 16-/32-output Models

Be sure to turn ON the start input. ("ST" will light on the display.)

Cam outputs and the RUN output are not turned ON unless the start input is turned ON.

For details of operation chart, refer to "Appendix D Operation Timing Chart".

3.7 Operation

Set the mode switch to RUN to start the operation.



■ For 16-/32-output Models

Be sure to turn ON the start input. ("ST" will light on the display.)

Cam outputs and the RUN output are not turned ON unless the start input is turned ON.

For details of operation chart, refer to "Appendix D Operation Timing Chart".

■ Differences between the Run Mode and the Test Mode

In the Run mode, cam programs cannot be changed.

In the Test mode, cam programs can be changed while being executed. Therefore, the Test mode operation can be considered "operation for adjustment purposes."

The table below shows the differences between the two modes. Select an operation mode that suits the purpose of your operation.

	Run mode	Test mode	Remarks
Outputs (Cam, Pulse, RUN)	Turned on	Turned on	With 16-/32-output models, the start input must be ON.
Cam program	Checking only (*1 and *2)	Can be changed (*2)	
Speed display	Possible	Not possible	Refer to the display examples below.
All protection operation	Possible	Not possible	Refer to "3.11 All Protection Function".
Switch to the function setting mode	Not possible	Not possible	
Origin setting	Not possible	Possible	Refer to "3.4 Setting the Origin".
Clear	Not possible	Possible	Refer to "3.8 Clearing the Settings".
Bank switching (16-/32-output models only)	Possible (*3)	Possible (*4)	Refer to "4.8 Bank Function (F7/F8/F9)".
ADV function setting	Not possible	Possible (*2)	Refer to "4.2 Advance Angle Compensation (ADV) Function".

*1: Not possible when the all protection function is enabled.

*2: Not possible for cams with the cam protection function being enabled.

*3: Switching in response to inputs at "bank input terminals" only

*4: Switching in response to inputs at the "bank input terminals" or the [BANK] key. (selectable)

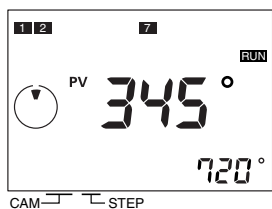

Display example in the Run mode

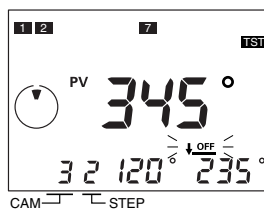

Display example in the Test mode

3.8 Clearing the Settings

The two methods for clearing settings are provided: clearing by steps/cams/banks and "all clear", where all the settings are cleared collectively.

The table below shows the details of the data to be cleared.
(The bank function is available only with 16-/32-output models.)

		Target step	Target cam	Target bank	Advance angle compensation	Function setting mode	Origin data
Clear items individually	By steps	○	×	×	×	×	×
	By cams	○	○	×	×*2	×	×
	By banks	○	○	○	○*3	×	×
All clear		○				○*1	×

○: Cleared ×: Not cleared

- *1: The settings in the function setting mode are reset to the factory settings. (Refer to "Appendix C List of Settings".)
- *2: If the settings are cleared by cams, the advance angle compensation (ADV) function setting of the cam subject to the clear operation is not cleared.
- *3: ADV function settings of all cams in the bank subject to the clear operation are also cleared.

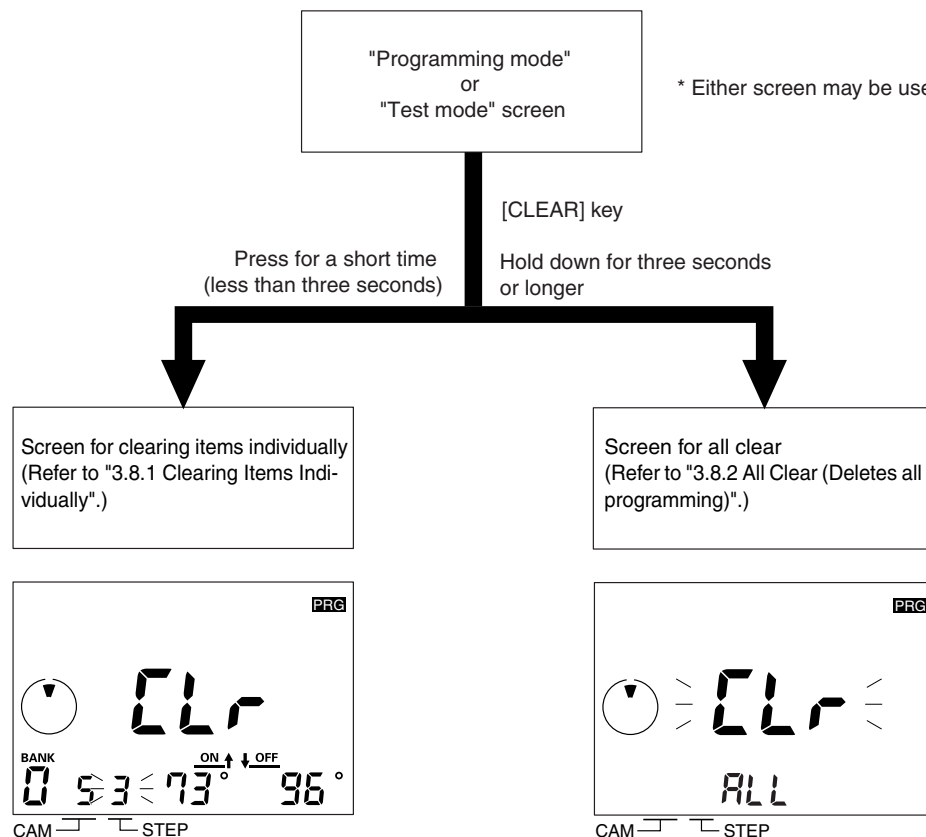

3.8.1 Clearing Items Individually

The procedure for clearing individual steps, cams, and banks is explained below.

- Set the mode switch to PRGM or TEST.

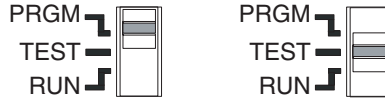

- Press the [CLEAR] key for a short time (less than three seconds) to display for clearing items individually. In this state, pressing the [WRITE] key enables to clear the settings by steps being displayed, and pressing the CAM or [BANK] key will display a clear screen for by cams or by banks.

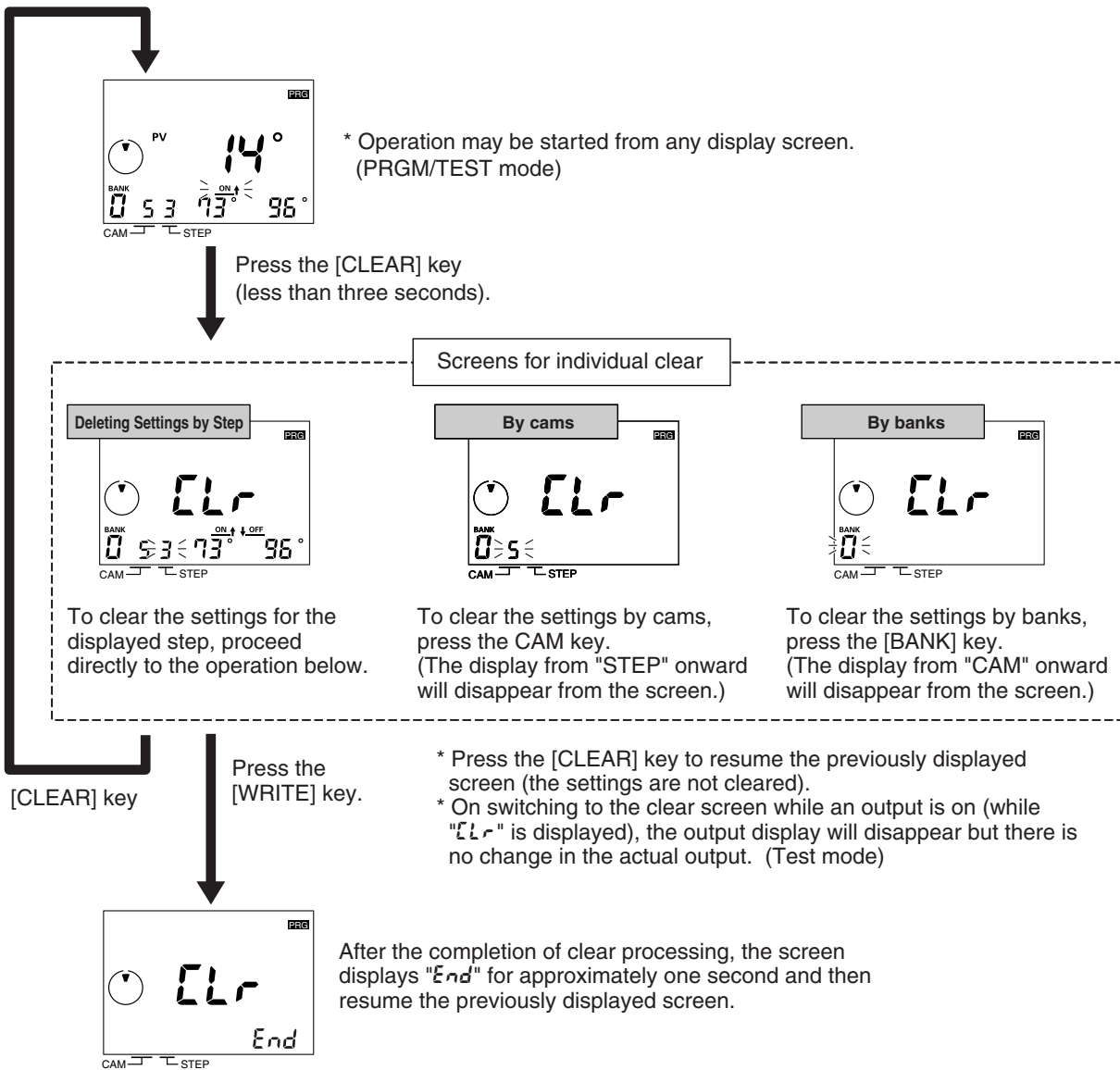

3.8.2 All Clear (Deletes all programming)

The section below explains the procedure for clearing all programs.

- Set the mode switch to PRGM or TEST.

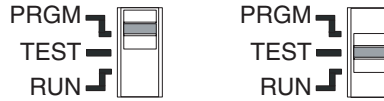

- Hold the [CLEAR] key down for at least three seconds to set the all clear mode.
Simply press the [WRITE] key to clear all programs.

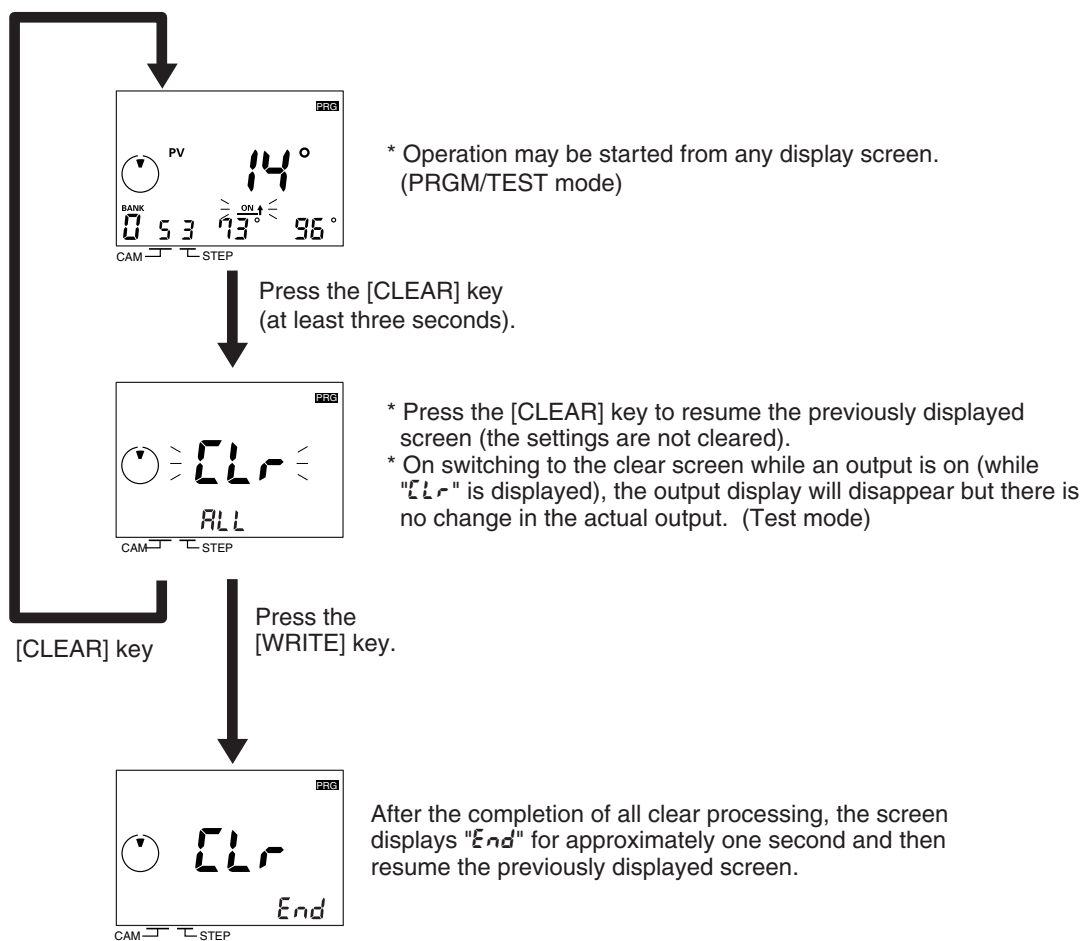

3.9 Checking the Settings in the Run Mode

The section below explains the procedure for checking cam programs in the Run mode.



- Press the [CHECK] key to check the programmed ON/OFF angles.

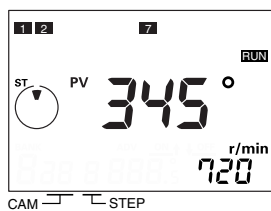

* Operation may be started from any display screen. (RUN mode)

Press the [CHECK] key.

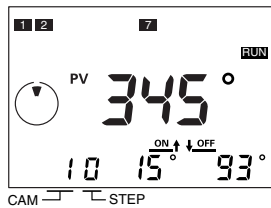

The cam programs are displayed in the sequence as they were written. (Cams and steps where ON/OFF angles are not set are skipped.)

[CHECK] key

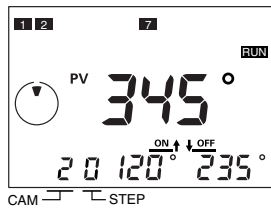

Pressing the CAM keys ([+], [-]) and the STEP keys ([+], [-]) enables to designate the cam number and the step number to be checked directly. In this operation, the cams and steps where ON/OFF angles are not set are displayed.

[CHECK] key

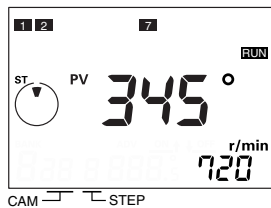

After checking all programs, the previous display will be resumed. If there is no key operation for 10 seconds or longer during the checking operation, the previous display will be resumed.

3.10 Switching the Display between Speed and Angle

The displayed information ("Angle" and "Speed") can be switched between Main display and Sub-display (only in the Run mode).

Pressing the [ON↑ ↓OFF] key for one second will toggle the information displayed at Main display and Sub-display between "Angle" and "Speed"

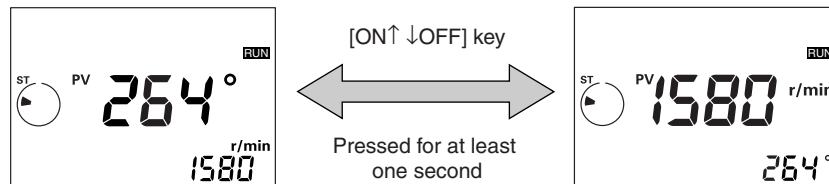

Main display (red): Present angular position
Sub-display (green): Speed (r/min)

Main display (red): Speed (r/min)
Sub-display (green): Present angular position

- The display pattern setting is retained even after the power is turned off. Accordingly, the screen displays information in the same pattern as before the power was turned off.
- This function is not reset even by executing the all clear function. (Refer to "3.8.2 All Clear (Deletes all programming)".)
- The speed is detected/updated in 200-ms intervals.
- With a resolution setting of 256 per rotation, the speed is not displayed as continuous values; some values are skipped.
Example: 0, 1, 2, □, 4, 5, 6, 7, 8, 9, □, 10, 11...
- Speeds up to 1,999 r/min can be displayed. Note that 1,999 r/min will remain displayed until the error code E21 appears even if the actual speed is 2,000 r/min or higher.
(Use the Cam Positioner at a speed slower than the maximum response speed.)

3.11 All Protection Function

The all protection function disables all operations (keys and switches) in the Run mode.

Since the status of the Cam Positioner when the all protection function was enabled remains in memory even after the power is turned off, the settings are protected from incorrect or unauthorized operations.

- **Display** The **OT** symbol appears at the upper right of the screen when the all protection function is enabled.
- **Operation mode** When the mode switch is set to TEST or PRGM, the Run mode remains in effect.
The **OT** symbol flashes at intervals of approximately 0.5 second if the mode switch is moved from Run to TEST or PRGM, indicating that the setting can not be changed.
- **Key operation** All key operations are disabled.
- **DIP switch** Changing the DIP switch setting used to select the rotation direction and the resolution of an Encoder is also disabled.
As the DIP switch settings are read when the power is turned on, when the power is turned on after changing the DIP switch settings, the **OT** symbol flashes at intervals of approximately 0.5 second to indicate that the settings cannot be changed.

■ Operation

In the Run mode, hold the [ADV] key down for at least five seconds.

To cancel the all protection function, do the same way.

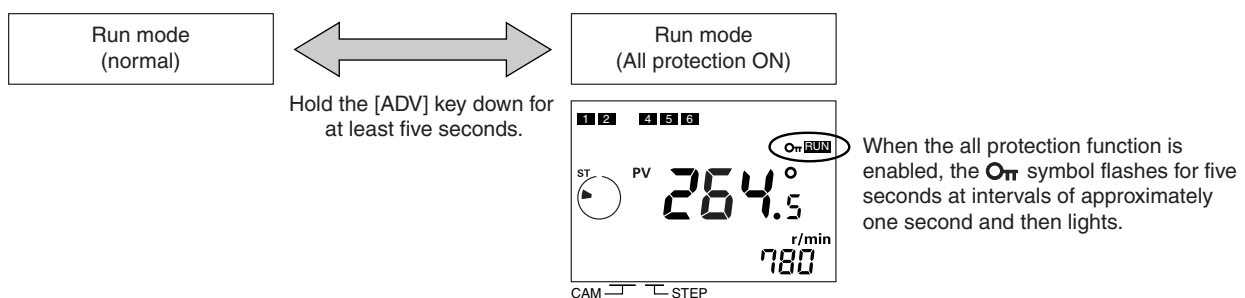

Section 4 HOW TO USE THE ADVANCED FUNCTIONS

The basic operation of the H8PS Cam Positioner can be mastered by following the explanations in Section 3.

Section 4 deals with the functions that make operation easier, and the advanced functions.

The functions explained in this section can be really advantageous depending on the application. Please read about these functions and become familiar with them so that you can use the appropriate functions for efficient operation.

4.1	Mode Transitions.....	4-2
4.2	Advance Angle Compensation (ADV) Function	4-4
4.3	Prohibiting Outputs	4-11
4.4	Pulse Output (F1/F2)	4-12
4.5	Speed Alarm (F3/F4)	4-15
4.6	Step Number Limit (F5)	4-20
4.7	Cam Protection (F6)	4-23
4.8	Bank Function (F7/F8/F9).....	4-24
4.9	E24 Detection Enable/Disable (F10)	4-32

4.1 Mode Transitions

8 output 16 output 32 output

The H8PS Cam Positioner has the modes shown below.

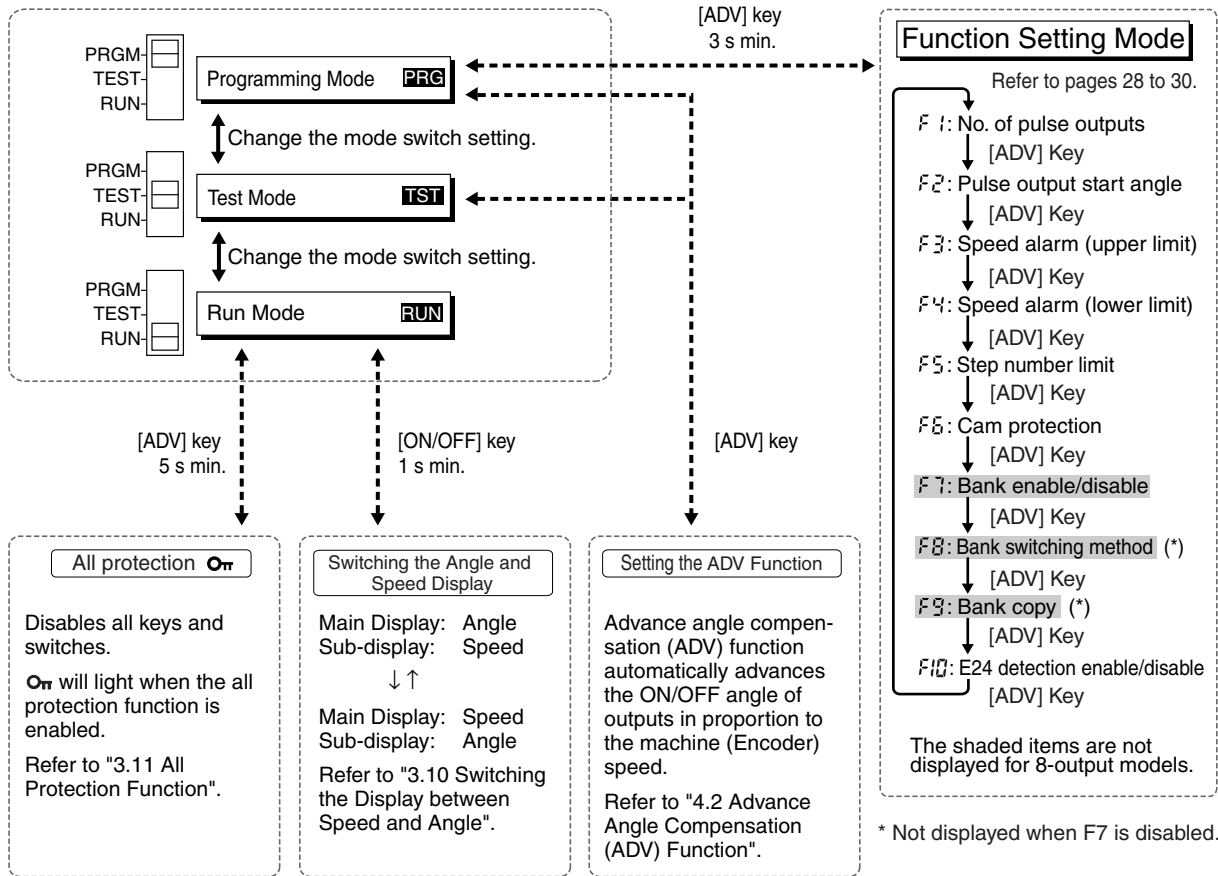

Operation mode	Display	Outline	Main functions
Programming mode	[PRG] lights.	In this mode, programming and setting, e.g. writing cam programs and setting ADV values, are performed. No outputs will be given in this mode.	<ul style="list-style-type: none"> • Writing cam programs (manual/teach) • Clearing cam programs • All clear • Setting the origin • Setting the ADV value • Switching to the function setting mode
Test mode	[TST] lights.	In this mode, programming and setting, e.g. writing cam programs and setting ADV values, are performed while confirming the outputs. This mode should also be selected for making adjustments such as changing the settings while running the Cam Positioner.	<ul style="list-style-type: none"> • Writing cam programs (manual/teach) • Clearing cam programs • All clear • Setting the origin • Setting the ADV value
Run mode	[RUN] lights.	In this mode, normal operation is performed. Programming and setting operations such as writing cam programs and setting ADV values are not possible.	<ul style="list-style-type: none"> • Checking cam programs • Switching the display between Speed and Angle • All protection
Function setting mode		In this mode, the convenient functions and advanced functions are set.	<ul style="list-style-type: none"> • F1 Number of pulse outputs • F2 Pulse output start angle • F3 Speed alarm (upper limit) • F4 Speed alarm (lower limit) • F5 Step number limit • F6 Cam protection • F7 Bank enable/disable • F8 Bank switching method • F9 Bank copy • F10 E24 detection enable/disable

4.2 Advance Angle Compensation (ADV) Function

8 output 16 output 32 output

4.2.1 What Is the Advance Angle Compensation (ADV) Function?

The ADV function advances the ON/OFF timing relative to the preset value and proportional to the Encoder rotation speed. As the speed of the machine increases, the system can be affected by the delay in outputs. If the ADV function is used, the output delay caused by higher speeds is automatically compensated.

■ General Concept of the ADV Function

The ADV value (point A) is set for a particular speed (2° at 100 r/min in this example), ADV value is used to linearly compensate outputs according to the speed based on an ADV value set for a specific speed.

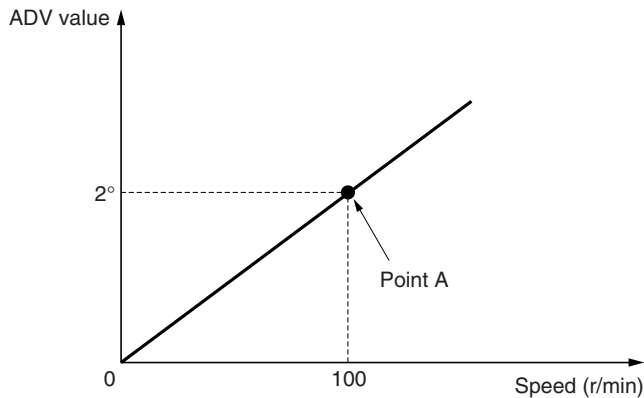

Speed (r/min)	ADV value (°)
0	0
⋮	⋮
50	1
⋮	⋮
100	2
⋮	⋮
500	10
⋮	⋮

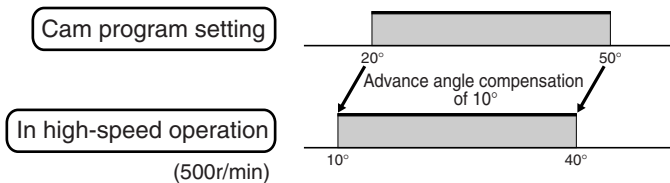

4.2.2 Specifications of Advance Angle Compensation Function Setting

■ The Number of Advance Angle Compensation Function Setting Enabled Outputs

The function can be set for seven outputs (cam No. 1 to 7).
(Common to all of the 8-/16-/32-output models)

The settings for each of the seven outputs can be made independently.

■ Settings (setting ranges)

When setting the ADV function, the speed and ADV value must be set.

If "---" is set for either of these settings, the ADV function is disabled for the corresponding cam

Encoder		Speed	ADV value (*)
Resolution	Display angle		
256	256	"---", 1 to 1600	"---", 0 to 255
256	360	"---", 1 to 1600	"---", 0 to 359
360	—	"---", 1 to 1600	"---", 0 to 359
720	—	"---", 1 to 800	"---", 0 to 359.5

* Even if the ADV value is set to 0°, the cam must be included in the number of cams with ADV values set, which affects the maximum response speed.

■ Maximum Response Speed

The maximum response speed will decrease as shown in the following table when ADV values are set for 4 cams or more.

The number of cams with ADV settings	Encoder resolution	Max. response speed
0 to 3	256/360	1600 r/min (*2)
	720	800 r/min
4 to 7	256/360	1200 r/min (*1, *2)
	720	600 r/min (*1)

*1 The setting range for the ADV value is the same as that when the number of cams with ADV values is 0 to 3.

*2 The maximum speed is 1,000 r/min when an E6CP-AG5C-C Encoder is connected.

■ Advance Timing Refreshing Period

200 ms

This is the time taken for one cycle, i.e. "measuring the speed/calculating the ADV value/making the output effective".

■ Precautions on Using the Advance Angle Compensation Function

● Maximum amount of angle compensation

In some cases the calculated amount of angle compensation may exceed 360° depending on the setting. In these cases the amount of angle compensation is clamped at 360° as shown in the figure below. Take this into consideration and set an ADV value appropriate for the speed in actual operation.

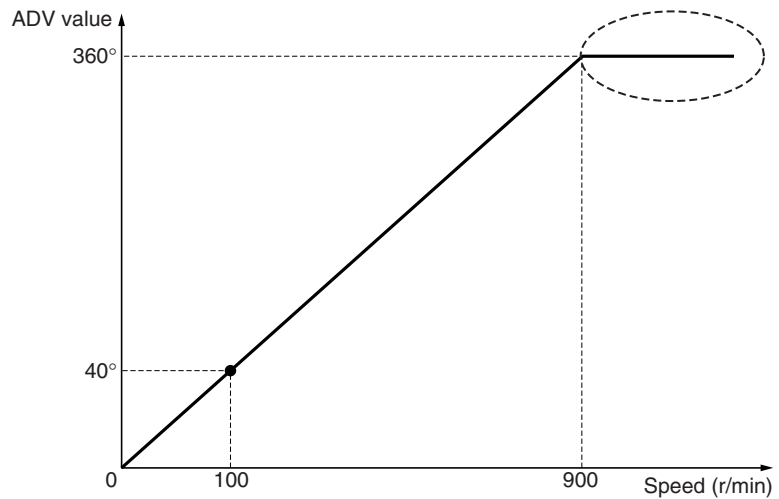

● Precautions on the deceleration stage

As described above, the ADV function executes one "measuring the speed/calculating the advance angle/making the output effective" cycle every 200 ms. This enables to advance the output ON/OFF timing correctly while the speed is accelerating as well as during high-speed operation. However, the function must be used carefully if the operation has a deceleration stage since the problem described below may occur during such an operation stage.

- Conditions

- There is a step deceleration during one turn of the machine (Encoder).
- The set duration of each output is short.

- Output operation

Although the program includes a single ON/OFF operation as shown below, output may turn ON/OFF more than one time as shown below.

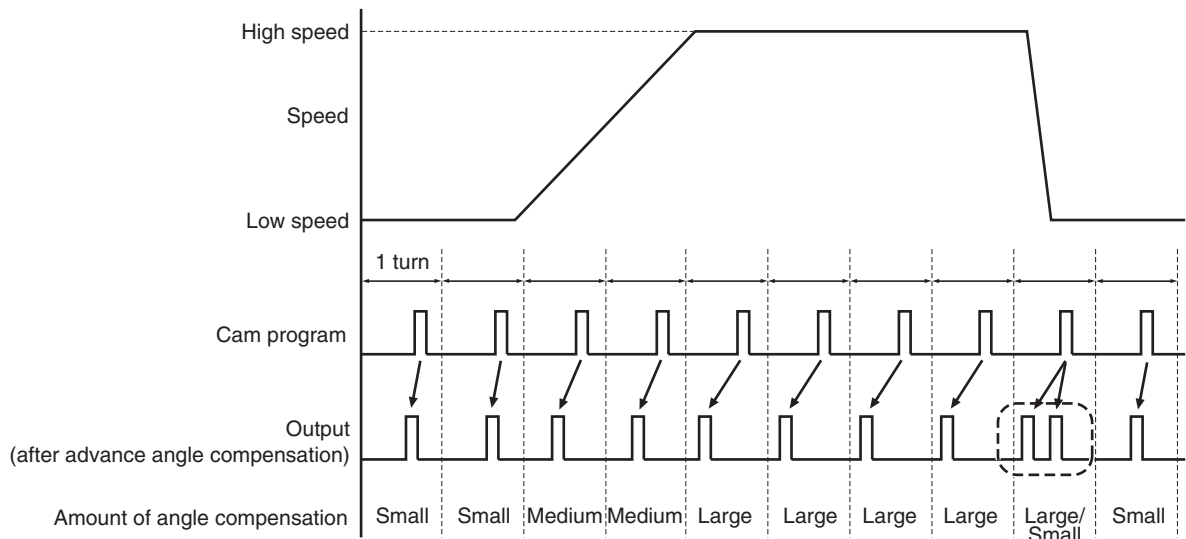

The output is turned ON at the advanced timing by angle compensation during high-speed operation. The calculation is executed again during a low-speed operation after the steep deceleration, causing the output to turn ON again.

- Example countermeasures

- Make the duration of each output as long as possible. This decreases the possibility that the output will turn on again during a steep deceleration.

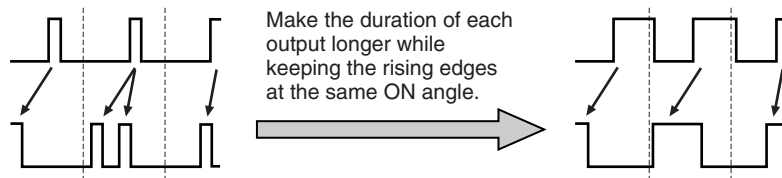

- Consider using an external sequence circuit that will not be affected by outputs turning on more than one time during a steep deceleration (e.g. one that detects the rise of the first pulse only).
- Design the system so that the variation in amount of angle compensation will be as small as possible.
- Examine the possibility of reducing the variation in amount of angle compensation by slowing the deceleration, or increasing the operating speed of the peripheral device (or reducing the speed of the drive shaft) to reduce the compensation amount itself.
- Run the system only after the speed has stabilized.

Run the system for production only after ensuring that the machine operates normally.

4.2.3 Operation

<Example>

Setting an ADV value for cam 4 (speed: 100 r/min, advance angle: 2°)

(The same example as explained in "4.2.1 What Is the Advance Angle Compensation (ADV) Function?")

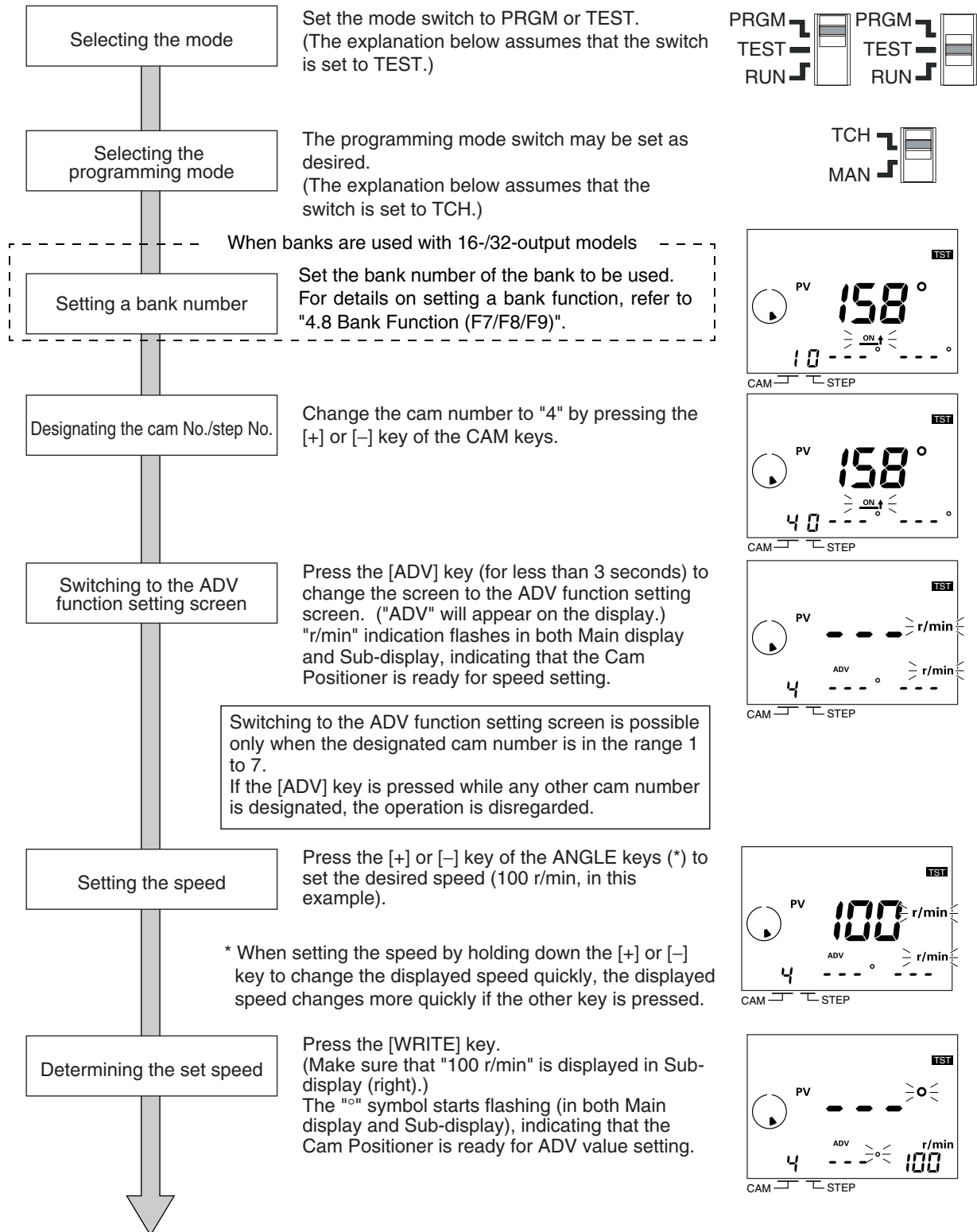

HOW TO USE THE
ADVANCED FUNCTIONS

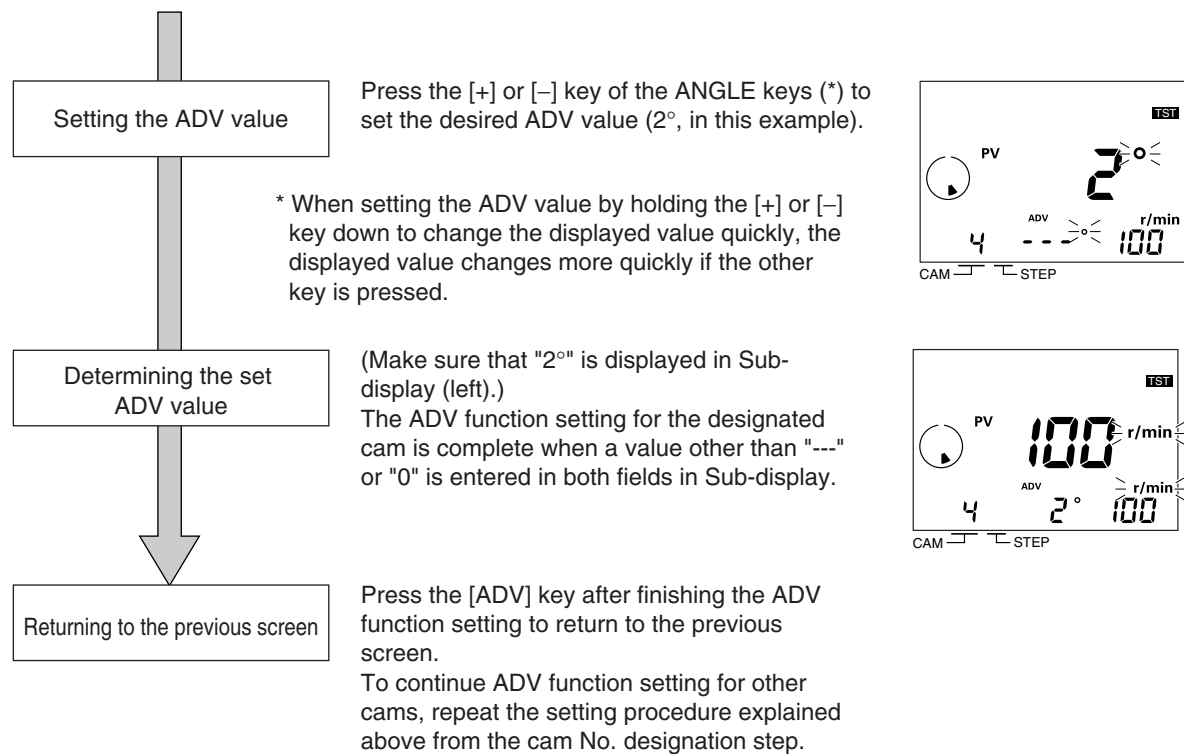

■ Clearing the ADV Function Setting

Setting "---" for either the speed or ADV value disables the ADV function setting for that cam, which effectively means that the ADV function setting is cleared.

Although the ADV function is disabled if "0" is set for the ADV value, the cam concerned is included in the "number of cams with the ADV function", which affects the maximum response speed.

Note that the ADV function setting is not cleared even if the target cam program is cleared using the [CLEAR] key.

(Refer to "3.8 Clearing the Settings".)

■ Relationship between the Speed Alarm (upper limit) and the ADV Function

With an 8-output model, cam 7 may be allocated to the speed alarm (upper limit).

Although ADV function setting is still allowed under these circumstances, the actual operation of the output is the speed alarm (upper limit).

4.3 Prohibiting Outputs

As explained in "3.7 Operation", with 16-/32-output models, outputs do not turn on unless the "start input" is input.

In other words cam outputs are prohibited if the start input is turned off, as shown in the figure below.

Note that although the run output turns off if the start input turns off, the pulse outputs are not affected by the turning off of the start input.

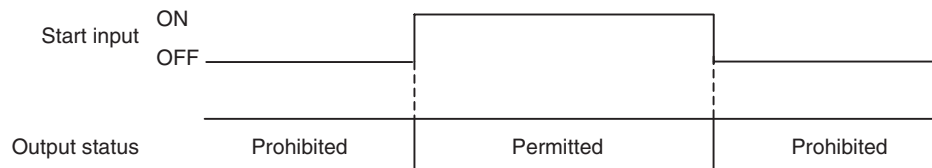

* For details of timing, refer to "Appendix D Operation Timing Chart".

4.4 Pulse Output (F1/F2)

8 output 16 output 32 output

It is possible to output the desired number of pulses during one turn of the Encoder.

Output pulses can be used as outputs to a rotation meter and the ability to set the number of pulses per turn as required makes selection of the device to be connected easier.

The fact that it is also possible to set the pulse output timing allows the H8PS Cam Positioner to be used for setting the system operating timing and similar applications.

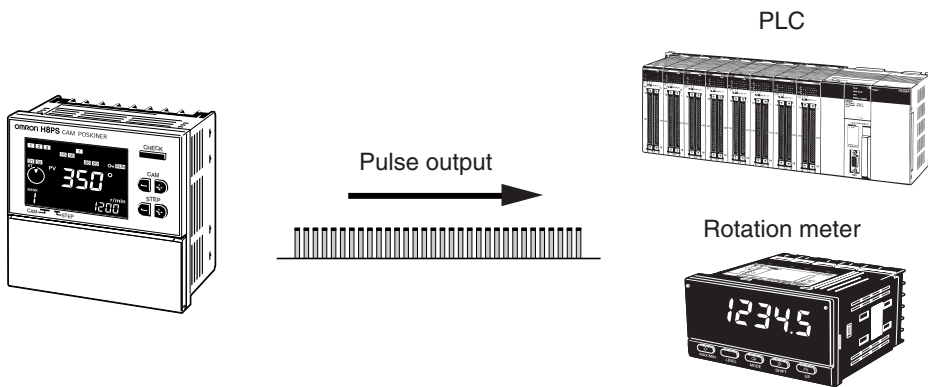

<Example 1>

Number of output pulses: 20, start angle: 0°

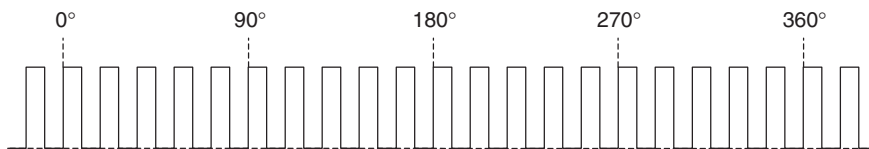

<Example 2>

Number of output pulses: 4, start angle: 10°

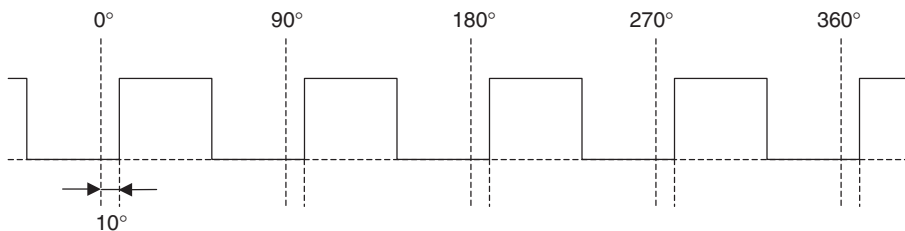

* In Example 2, setting a pulse output start angle of 100°, 190° or 280° would result in the same pattern of pulse outputs.

4.4.1 Setting the Number of Pulse Outputs (F1)

Set the number of output pulses in the function setting mode.

- Parameter

Encoder resolution	The settable number of pulses
256	1,2,3,4,5,6, 9,10,12,15,18,20, 30,36, 45, 60 , 90
360	1,2,3,4,5,6, 9,10,12,15,18,20, 30,36, 45, 60 , 90, 180
720	1,2,3,4,5,6, 9,10,12,15,18,20,24,30,36,40, 45, 60 ,72, 90,120, 180,360

* The numbers in *italic* indicate the default values.

■ Operation

<Example>

Changing to 90 pulses per rotation

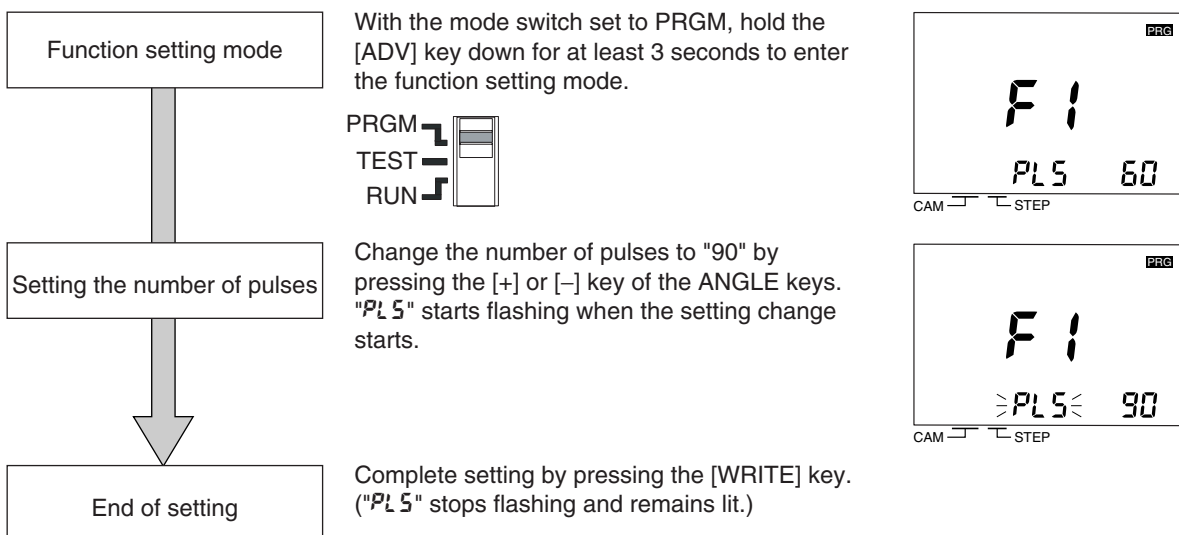

4.4.2 Setting the Pulse Output Start Angle (F2)

Set the pulse output start angle in the function setting mode.

- Parameter

Encoder resolution	Pulse output start angle setting range
256 (256 display)	0 to 255
256 (360 display)	0° to 359° (Not all angles can be set. Refer to "Appendix E Angle Data Table (256 Resolution)")
360	0° to 359°
720	0° to 359.5°

* The default value is 0°

■ Operation

<Example>

Setting the pulse output start angle to 100°

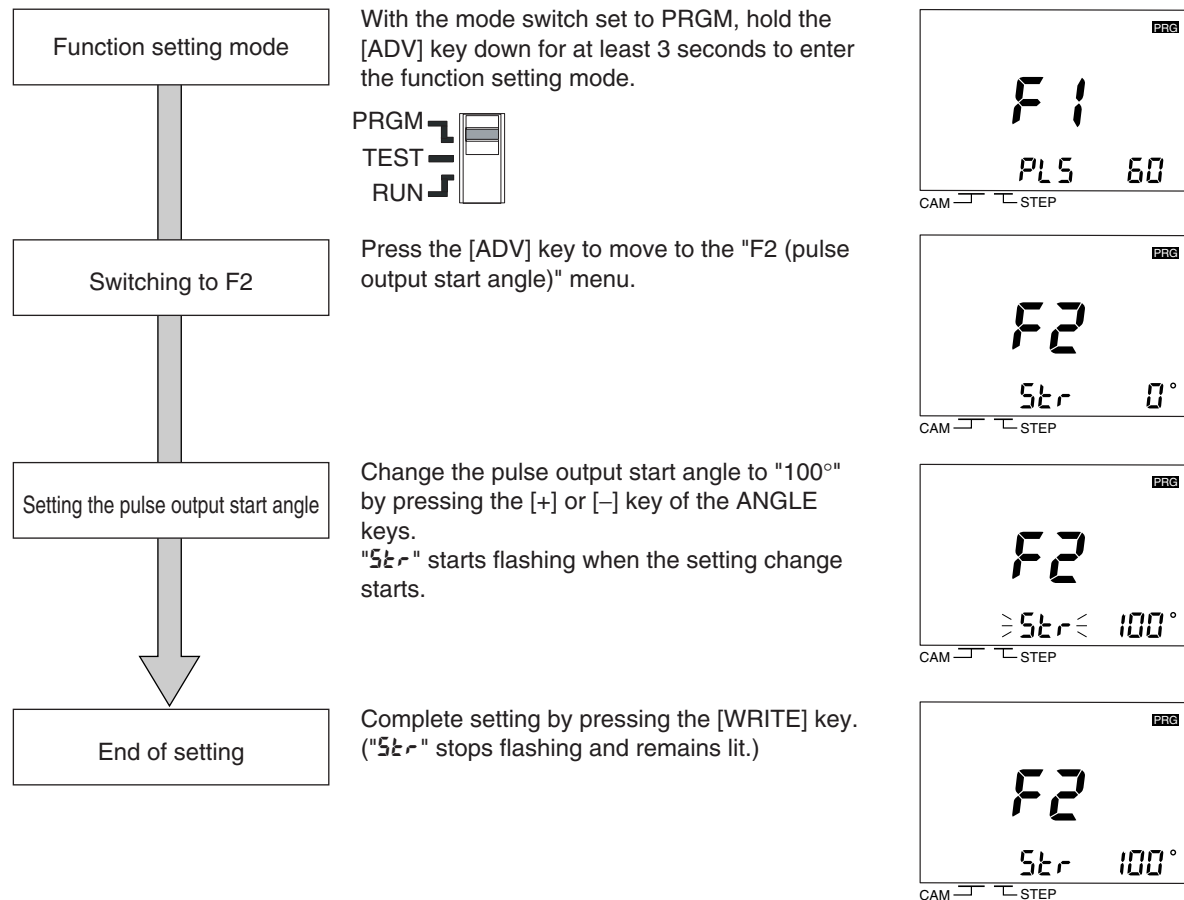

4.5 Speed Alarm (F3/F4)

8 output

16 output

32 output

The H8PS Cam Positioner allows the speed alarm function to be allocated to an output in addition to its capability to display the speed.

Since "speed alarm (upper limit)" and "speed alarm (lower limit)" are allocated to different outputs, this function can be used in conventional ways to meet the requirements for various applications.

Thanks to this feature, one H8PS Cam Positioner unit can be used for applications where previously a rotation meter would have had to be installed separately or a PLC would have been used to process the data.

● Speed Alarm outputs

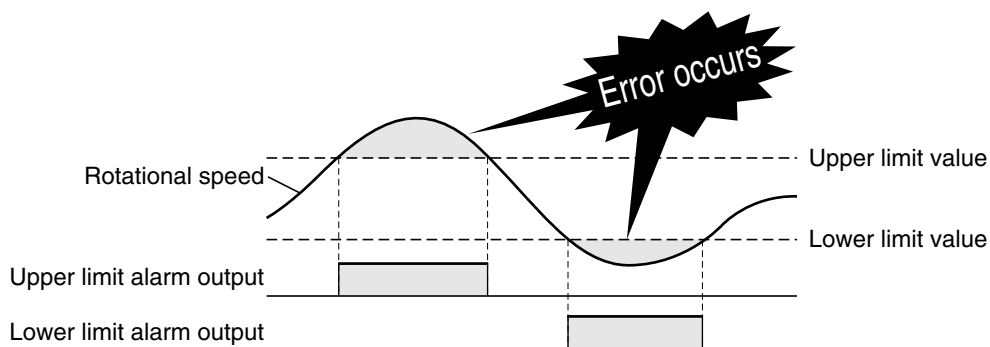

■ Output Allocation

The speed alarm output is allocated to the designated cam number as shown in the table below.

In the default setting, the speed alarm output is not allocated. However, if any value (0 to 1600 (800)) other than "---" is set for the speed alarm value, the normal ON/OFF program (including angle advance setting) of the corresponding cam number is disabled. (Even in this case, the program of the corresponding cam number is not cleared.)

Speed alarm output allocation

	Upper limit alarm output	Lower limit alarm output
H8PS-8□ (8-output model)	Cam 7	Cam 8
H8PS-16□ (16-output model)	Cam 15	Cam 16
H8PS-32□ (32-output model)	Cam 31	Cam 32

1. Setting only an upper or lower limit is allowed.
2. The speed alarm can be set independently for each bank.
(When banks are used with 16-/32-output models)

4.5.1 Setting the Speed Alarm (Upper Limit) (F3)

Set the speed alarm upper limit using the F3 menu in the function setting mode.

● Parameter

Set the speed alarm upper limit.

If it is set to "---", the upper limit speed alarm function is disabled and the output can be used as a normal cam output.

Encoder resolution	Speed setting range
256	"---" or 0 to 1600
360	
720	"---" or 0 to 800

* The default value is "---".

■ Operation

<Example>

Setting the upper limit alarm value to "700 r/min" for a 16-output model

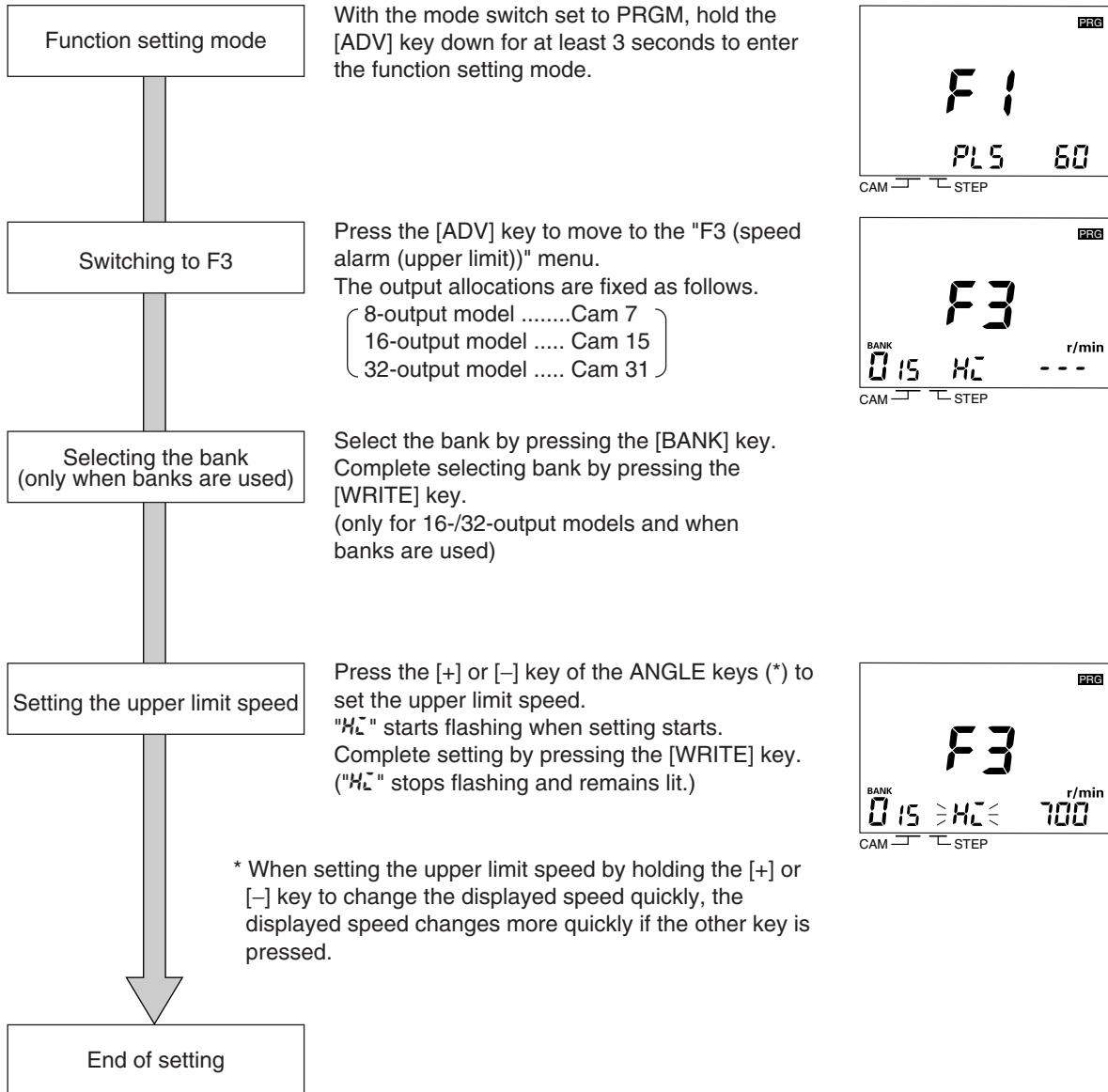

4.5.2 Setting the Speed Alarm (Lower Limit) (F4)

Set the speed lower limit alarm using the F4 menu in the function setting mode.

● Parameter

Set the lower limit alarm speed.

If it is set to "---", the lower limit speed alarm function is disabled and the output can be used as a normal cam output.

Encoder resolution	Speed setting range
256	"---" or 0 to 1600
360	
720	"---" or 0 to 800

* The default value is "---".

■ Operation

<Example>

Setting the lower limit alarm value to 20 r/min for a 16-output model

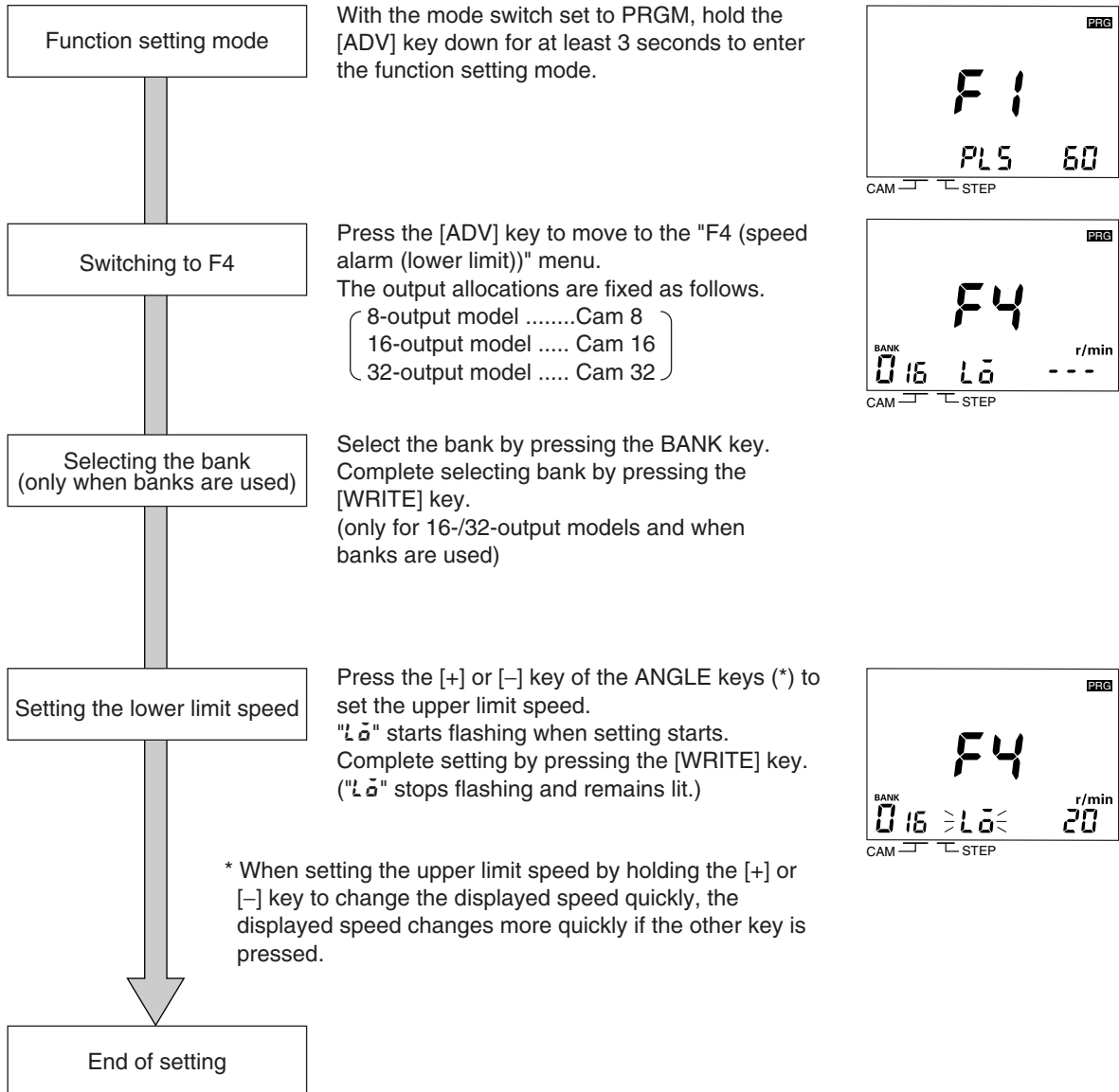

4.6 Step Number Limit (F5)

8 output

16 output

32 output

The H8PS Cam Positioner has the capacity to make a 10-step program for each cam. It also has a function to limit the number of programmable steps.

The step number limit function may be used in cases where, for example:

Making/changing cam programs is to be allowed, but addition of a program by operation errors must be avoided.

This function provides two limiting methods: "collective setting for all cams," and "independent setting for each cam".

Setting is accomplished using the F5 menu of the function setting mode.

■ Operation

<Example 1>

Limiting the number of steps to "2" for all cams collectively

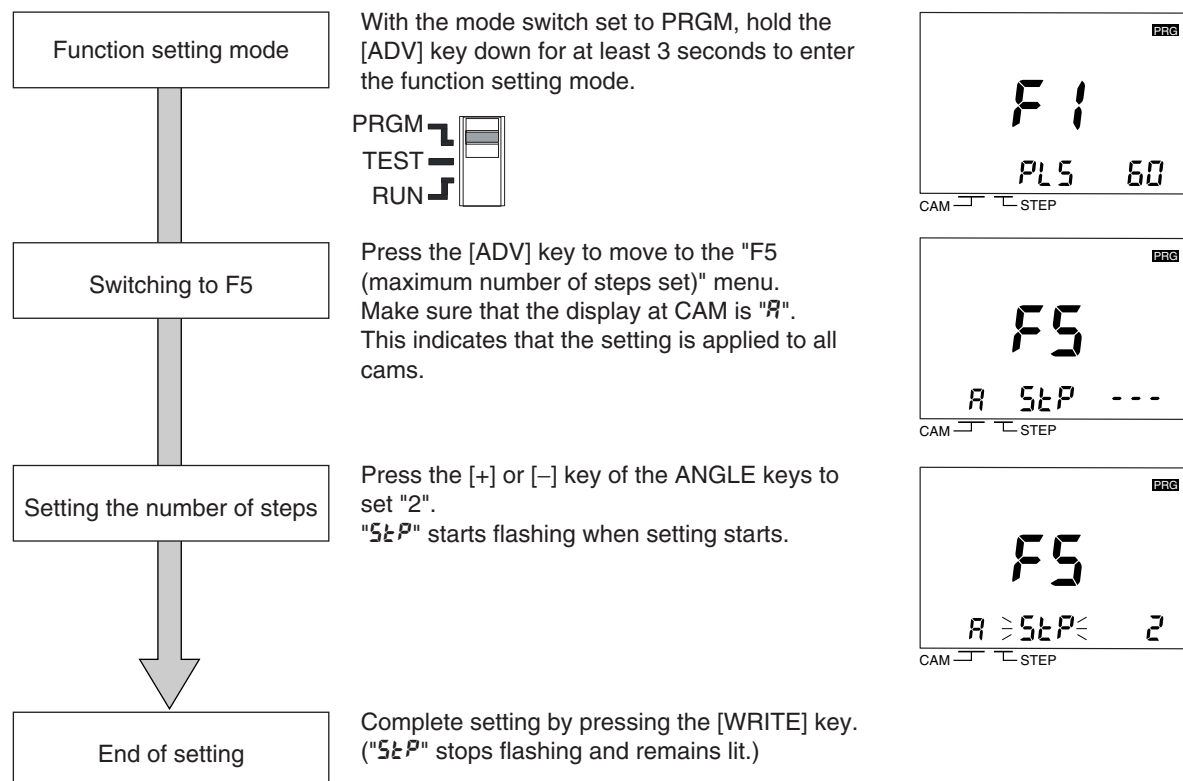

<Example 2>

Limiting the number of steps to "1" for cam 3

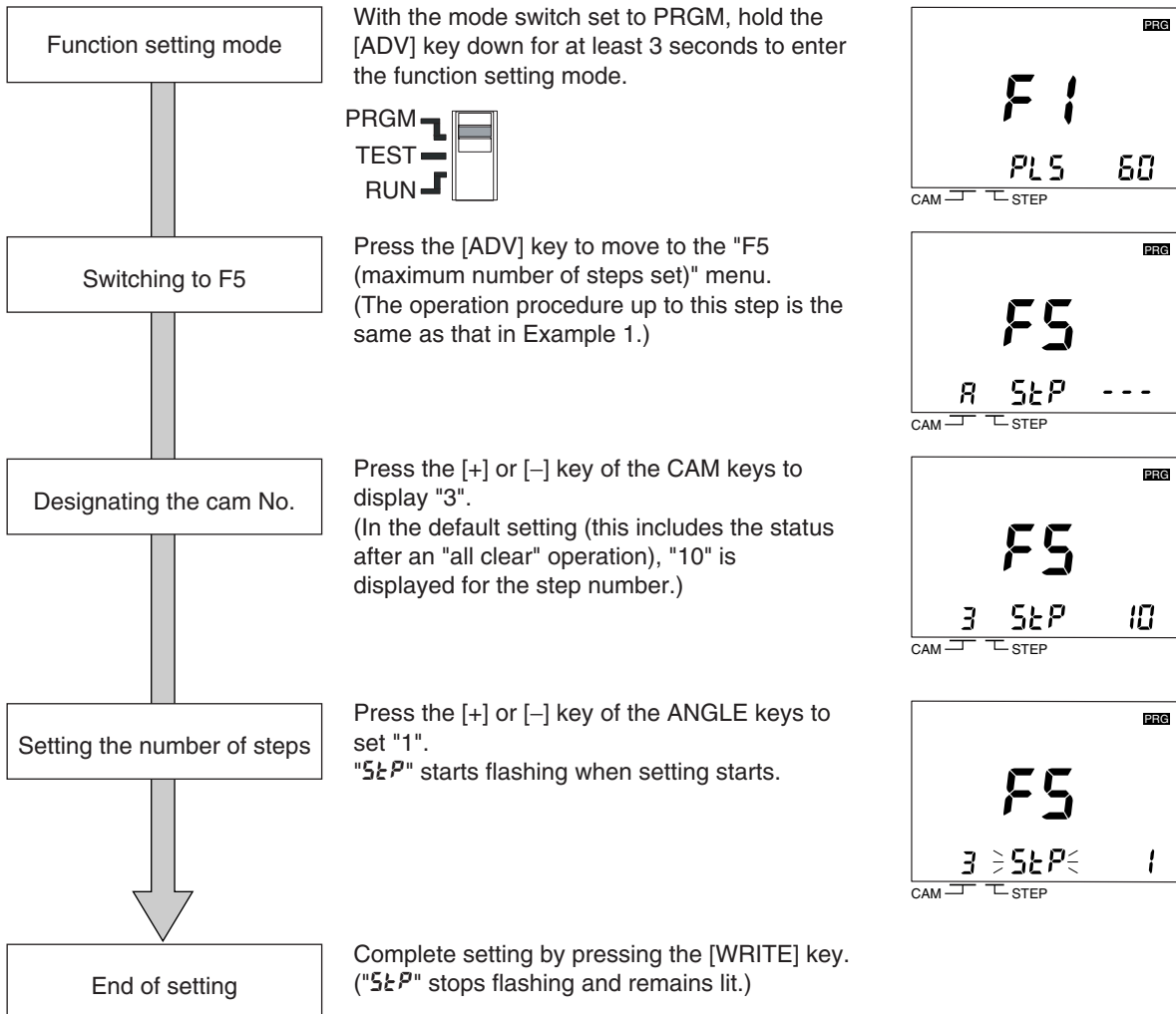

● Precautions on using the step number limit function

Before setting the step number limit function, make sure that a program has not been set for the target cam.

If this function is set without due care as in the case shown below, a cam program that cannot be checked in the programming mode could run.

	Step No.					
	0	1	2	...	8	9
Before setting the step number limit function	20° ON 30° OFF	70° ON 90° OFF	—	...	—	200° ON 230° OFF
Setting "2" as the limit of step numbers	20° ON 30° OFF	70° ON 90° OFF	—	...	—	200° ON 230° OFF

Programming is possible for up to 2 steps only (Step No. 0 and No. 1).

Program addition is not possible.

The output turns ON since this has been included in the program. (This step cannot be checked in the program check operation.)

4.7 Cam Protection (F6)

8 output

16 output

32 output

The H8PS Cam Positioner allows protection to be set, in cam units, to disable program writing.

The cam protection function may be used in cases like this:

The setting of the program of a specific cam number must not be changed.

This function can be used effectively to prevent malfunction.

■ Operation

<Example 1>

Protecting cam 3

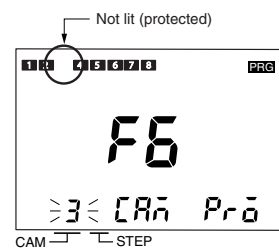
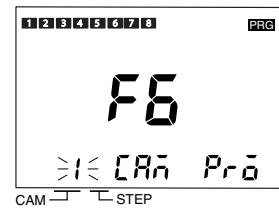
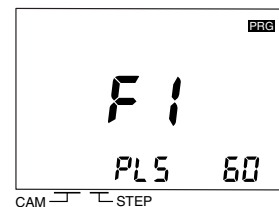
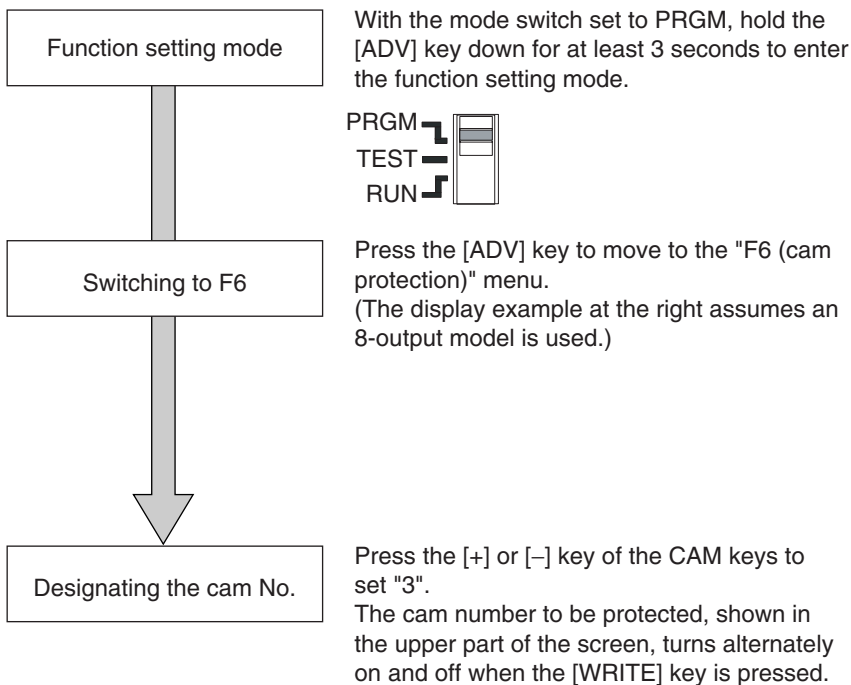

<Output display>

ON Cam protection OFF
(Lit) (Setting/confirmation can be done as desired for the target cam)

OFF Cam protection ON
(Not lit) (Setting/confirmation of the target cam is disabled unless the cam protection function is canceled.)

* In the default setting (this includes the status after an "all clear" operation), "cam protection" is OFF for all cams.

4.8 Bank Function (F7/F8/F9)

16 output 32 output

4.8.1 What Is the Bank Function?

The bank function is available with 16-/32-output models.

The bank function allows switching of the entire cam program. A program can be selected simply by selecting the corresponding bank number when changing the setup. (*)

* In the default setting (this includes the status after an "all clear" operation), the bank function is OFF.

- To use the bank function, switch the function ON using the F7 menu (Refer to "4.8.5 Enabling the Bank (F7)") in the function setting mode.

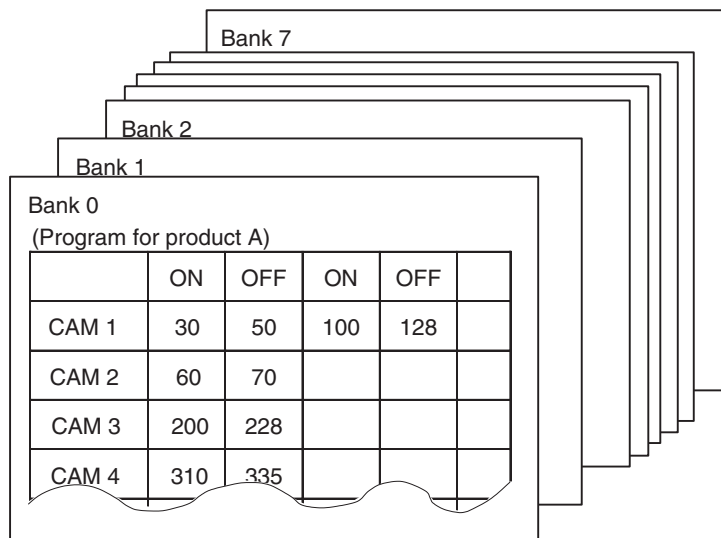

* Up to eight banks can be registered.

4.8.2 Switching the Active Bank

The two methods are provided for selecting the bank to be run: selection using the bank input (terminal block) and selection using the [BANK] key on the Cam Positioner unit.

For details, refer to the table below.

* In the default setting (this includes the status after an "all clear" operation), the "selection using the bank input terminals (㉔)" method is set.

If necessary, change the bank switching method using the F8 menu (Refer to "4.8.6 Selecting the Bank Switching Method (F8)") in the function setting mode.

	Description	Run mode	Test mode
Selection using the bank input terminals (㉔)	Designate the bank by "bank input" at the terminal block. If another bank is already set in the programming mode, the designation by bank input has priority over this setting and the designated bank is selected when the mode is changed to test or run (when the start input turns on).	Switchable (*1)	Switchable (*1)
Selection by BANK key (㉕)	The bank designated in the programming mode or test mode is selected. All the inputs from the bank input terminals are invalid.	Not switchable	Switchable (*2)

1. Control of the start input is necessary. For details of the timing, refer to "Appendix D Operation Timing Chart".
2. Refer to "4.8.3 Designating the Bank Using the Keys".

● Bank input terminals

Bank No.	Bank input terminals		
	1	2	3
0	OFF	OFF	OFF
1	ON	OFF	OFF
2	OFF	ON	OFF
3	ON	ON	OFF
4	OFF	OFF	ON
5	ON	OFF	ON
6	OFF	ON	ON
7	ON	ON	ON

ON: Shorted to COM terminal.

OFF: Open

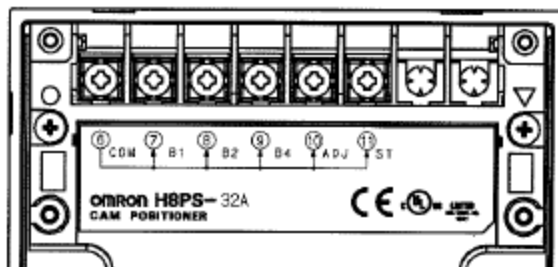

4.8.3 Designating the Bank Using the Keys

Use the [BANK] key on the front of the Cam Positioner unit to designate the bank in the programming and test mode.

Make sure that the display for the bank switching method is "KEY". (Refer to "4.8.6 Selecting the Bank Switching Method (F8)".)

<Example>

Switching the bank from bank 0 to bank 2

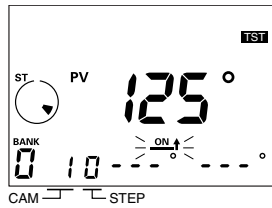

* Operation may be started from any display screen. (PRGM mode or TEST mode)



Press the [BANK] key.

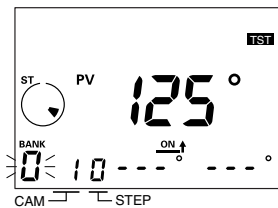

The displayed bank number starts flashing.

Press the [BANK] key.

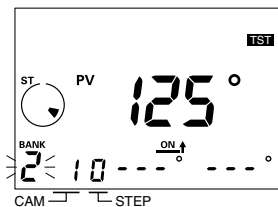

The bank number increases each time the [BANK] key is pressed. Press the [BANK] key repeatedly until the desired bank number is displayed. (The bank is not switched at this stage.)

Press the [WRITE] key.

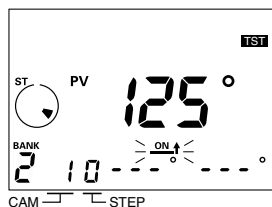

Selection of the displayed bank is complete when the [WRITE] key is pressed. The displayed bank number stops flashing and lights continuously. (The ON display starts flashing.)

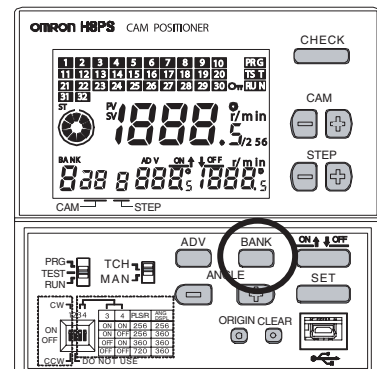

4.8.4 Bank Switching Timing

To switch the bank in the programming or test mode, the start input must be turned off and back on as shown below. This means the timing for turning the start input ON and OFF must be controlled appropriately. (*)

* Switching banks is possible even if the start input remains on by changing the mode switching setting like this: "RUN (TEST)" → "PRGM" → "RUN (TEST)". (This is because the start input is recognized as being off in the PRGM mode.)

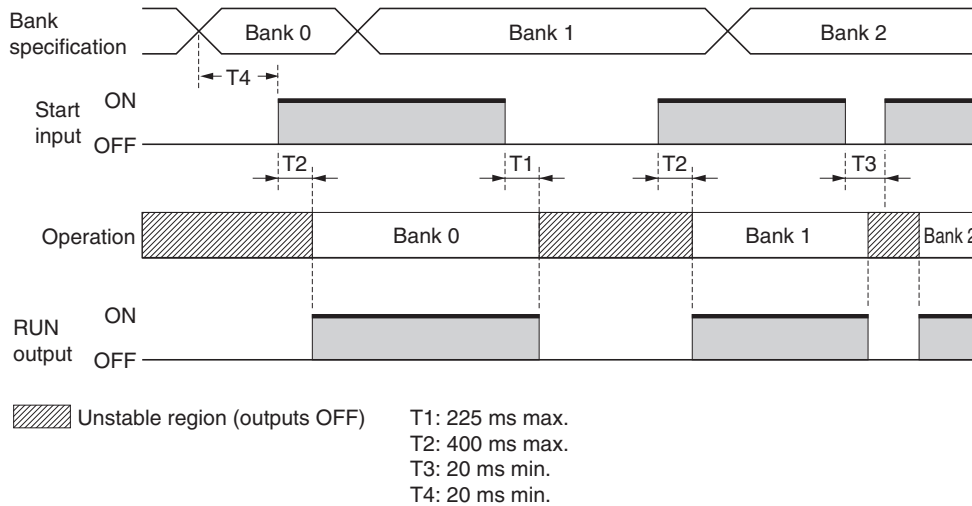

Refer to "Appendix D Operation Timing Chart" for the operation timing chart for H8PS Cam Positioner.

● Cautions on using banks

If the power is cycled after switching the bank but without setting a new bank by start input, the previously selected bank is set as the active bank.

4.8.5 Enabling the Bank (F7)

In the default setting, the bank function is disabled.

To use the bank function, it must be enabled by using the F7 menu (bank enable/disable) in the function setting mode.

● Parameter

Setting data	Description
no (No)	The bank function is disabled. The bank display is not shown in the RUN, TEST and PRGM modes. The [BANK] key and bank input are also disabled.
YES (Yes)	The bank function is enabled.

* The default setting is "no (No)".

■ Operation

<Example>

Enabling the bank switching function

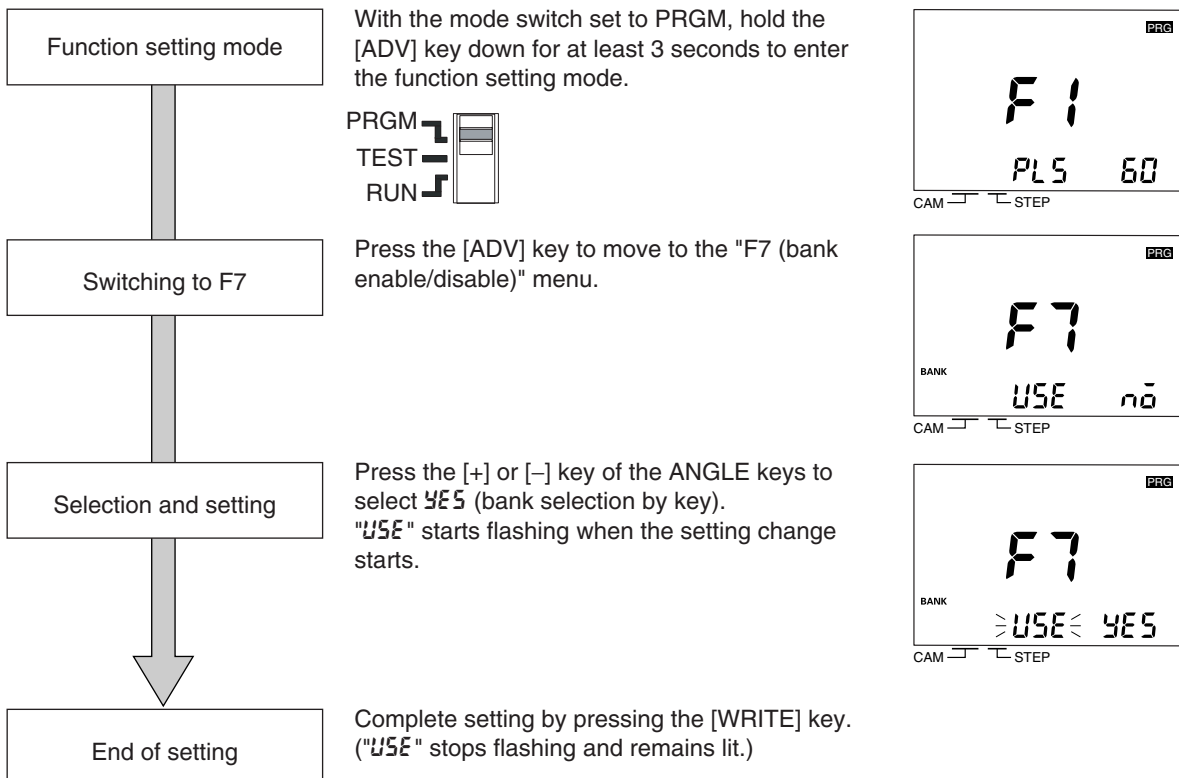

4.8.6 Selecting the Bank Switching Method (F8)

Select the method for switching the active bank using the operation below.

● Parameter

Setting data	Description
㊦ (in)	The bank can only be switched by means of the bank input at the terminals. If a different bank is displayed in the PRGM mode, the bank designated by the bank input at the terminals is selected when the mode is changed to TEST or RUN.
KEY (key)	The bank can only be switched with the [BANK] key. All the bank inputs at the terminals are disabled.

* The default setting is "㊦ (in)".

■ Operation

<Example>

Changing the bank switching method to "KEY (key)"

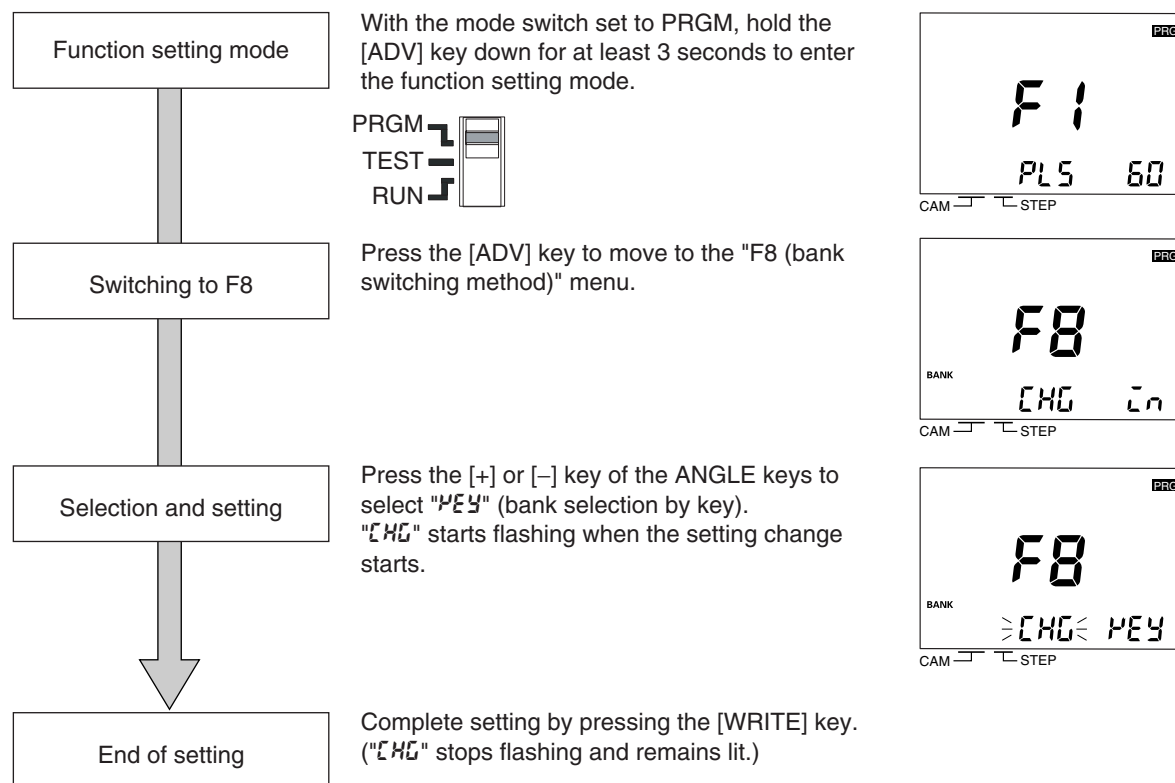

* This function (F8) can only be set when the bank function is enabled in the setting of F7.

4.8.7 Bank Copy (F9)

The bank copy function is used to copy a program in one bank to another.

If only some of ON/OFF angles differ between programs, this function makes it easy to create a program with different ON/OFF angles by copying the template program to another bank.

■ Operation

<Example>

Copying the program in bank 2 to bank 3

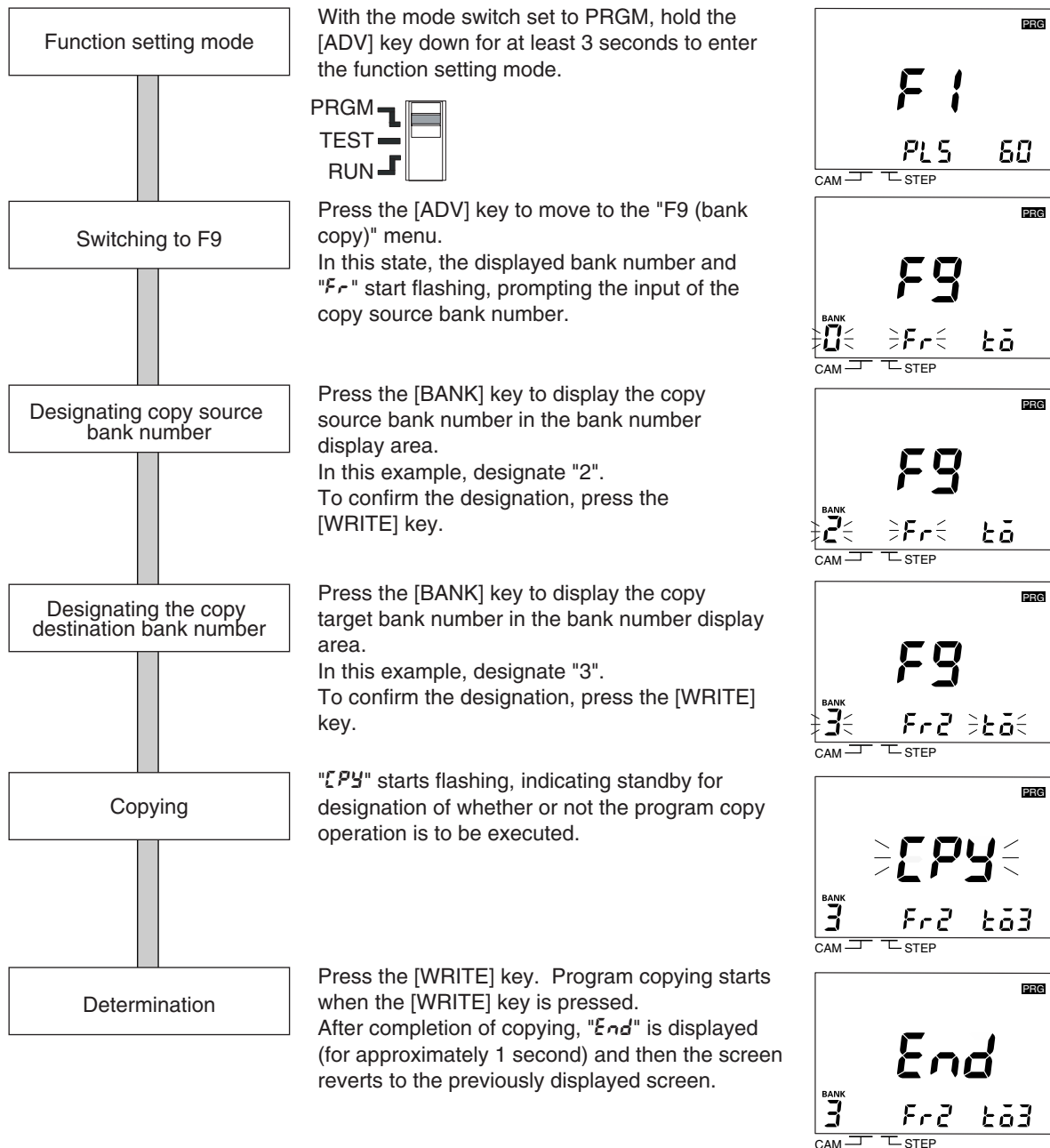

* This function (F9) can only be set when the bank function is enabled in the setting of F7.

4.9 E24 Detection Enable/Disable (F10)

8 output

16 output

32 output

The H8PS Cam Positioner allows the output of an error display (E24) when the connector of the connected Encoder is disconnected.

In normal operation the E24 detection function should be enabled to ensure safe operation.

If several H8PS Cam Positioner units are connected in parallel using a Y92C-30 Parallel Input Adapter, an E24 error might be output even if the Encoder is connected correctly. To prevent this problem, the E24 error detection function must be disabled.

Whether the E24 error detection function is enabled or disabled is set using the F10 menu in the function setting mode.

● Parameter

Setting data	Description
YES (enabled)	In the RUN or TEST mode, the E24 error code is displayed if the Encoder is not connected correctly.
NO (disabled)	E24 error is not detected.

* The default setting is "**YES** (enabled)".

■ Operation

<Example>

Changing the E24 detection function setting to "no (disabled)"

Function setting mode

With the mode switch set to PRGM, hold the [ADV] key down for at least 3 seconds to enter the function setting mode.

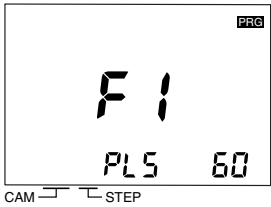

Switching to F10

Press the [ADV] key to move to the "F10 (E24 detection enable/disable)" menu.

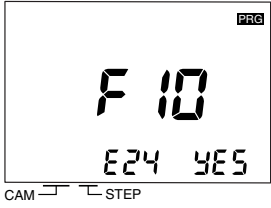

Selection and setting

Press the [+] or [-] key of the ANGLE keys to select no (disabled). "E24" starts flashing when the setting change starts.

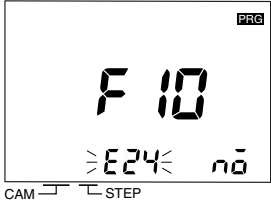

End of setting

Complete setting by pressing the [WRITE] key. ("E24" stops flashing and remains lit.)

HOW TO USE THE
ADVANCED FUNCTIONS

APPENDICES

Appendix A	Specifications (Ratings).....	A-2
Appendix B	Troubleshooting.....	A-5
Appendix C	List of Settings.....	A-11
Appendix D	Operation Timing Chart.....	A-14
Appendix E	Angle Data Table (256 Resolution)	A-16
Appendix F	Coding Sheet.....	A-17

Appendix A Specifications (Ratings)

■ Ratings and Characteristics

● Ratings

Item		H8PS-□B	H8PS-□BF	H8PS-□BP	H8PS-□BFP
Rated supply voltage		24 VDC			
Operating voltage range		85% to 110% of rated supply voltage			
Mounting method		Flush mounting	Surface mounting, track mounting	Flush mounting	Surface mounting, track mounting
Power consumption		Approx. 4.5 W at 26.4 VDC for 8-output models Approx. 6.0 W at 26.4 VDC for 16-/32-output models			
Inputs	Encoder input		Connections to a dedicated absolute encoder		
	External inputs	Input signals	8-output Models: None 16-/32-output Models: Bank inputs 1/2/4, origin input, start input		
		Input type	No voltage inputs: ON impedance: 1 kΩ max. (Leakage current: approx. 2 mA at 0 Ω) ON residual voltage: 2 V max., OFF impedance: 100 kΩ min., Applied voltage: 30 VDC max., Minimum input signal width: 20 ms		
Outputs	Cam outputs RUN output		NPN open-collector transistor outputs 30 VDC max., 100 mA max. (Do not exceed 1.6 A total for all cam outputs and the RUN output.), residual voltage: 2 VDC max.	PNP open-collector transistor outputs 30 VDC max. (26.4 VDC for 16-/32-output Models), 100 mA max. (Do not exceed 1.6 A total for all cam outputs and the RUN output.), residual voltage: 2 VDC max.	
	Pulse output		NPN open-collector transistor output 30 VDC max., 30 mA max., residual voltage: 0.5 VDC max.	PNP open-collector transistor output 30 VDC max. (26.4 VDC for 16-/32-output Models) 30 mA max., residual voltage: 2 VDC max.	
	Number of outputs		8-output Models: 8 cam outputs, 1 RUN output, 1 pulse output 16-output Models: 16 cam outputs, 1 RUN output, 1 pulse output 32-output Models: 32 cam outputs, 1 RUN output, 1 pulse output		
Number of banks		8 banks (for 16-/32-output Models only)			
Display method		7-segment, negative transmissive LCD (Main Display: 11 mm (red), Sub-display: 5.5 mm (green))			
Memory backup method		EEPROM (overwrites: 100000 times min.) that can store data for 10 years min.			
Ambient operating temperature		– 10 to 55°C (with no icing or condensation)			
Storage temperature		– 25 to 65°C (with no icing or condensation)			
Ambient humidity		25% to 85%			
Degree of protection		Panel surface: IP40, Rear case: IP20			
Case color		Light gray (Munsell 5Y7/1)			
Electromagnetic environment		Industrial electromagnetic (EN/IEC 61326-1 Table 2)			

● Characteristics

Setting unit		0.5° increments at a resolution of 720, 1° increments at a resolution of 256 or 360 (*1)
Number of steps		Up to 10 steps can be set for each cam to turn the output ON/OFF 10 times. (*2)
Inputs	Encoder input	<p>Connections to a dedicated absolute encoder</p> <ul style="list-style-type: none"> Response rotation speed (in Run/Test Mode) 1,600 r/min max. at a resolution of 256 or 360 (1,200 r/min max. if angle advancement is set for 4 or more cams) (*3) 800 r/min max. at a resolution of 720 (600 r/min max. if angle advancement is set for 4 or more cams) Includes error data detection
Encoder cable extension distance		<p>256/360 resolution 100 m max. at 330 r/min or less 52 m max at 331 to 1,200 r/min (331 to 900 r/min if angle advancement is set for 4 or more cams) 12 m max. at 1,201 to 1,600 r/min (901 to 1,200 r/min if angle advancement is set for 4 or more cams)</p> <p>720 resolution 100 m max. at 330 r/min or less 52 m max at 331 to 600 r/min (331 to 450 r/min if angle advancement is set for 4 or more cams) 12 m max. at 601 to 800 r/min (451 to 600 r/min if angle advancement is set for 4 or more cams)</p>
Output response time		0.3 ms max.
Insulation resistance		100 MΩ min. (at 500 VDC) between current-carrying terminals and exposed non-current-carrying metal parts, between all current-carrying parts and the USB connector
Dielectric strength		1,000 VAC, 50/60 Hz for 1 min between current-carrying terminals and exposed non-current-carrying metal parts 500 VAC, 50/60 Hz for 1 min between current-carrying section and USB connector, and between current-carrying terminals and non-current-carrying metal part of output connector
Impulse withstand voltage		1 kV between power terminals 1.5 kV between current-carrying terminals and exposed non-current-carrying metal parts
Noise immunity		± 480 V between power terminals, ± 600 V between input terminals Square-wave noise by noise simulator (pulse width: 100 ns/1 μs, 1-ns rise)
Static immunity		8 kV (malfunction), 15 kV (destruction)
Vibration resistance	Destruction	10 to 55 Hz with 0.75-mm single amplitude each in 3 directions for 2 hours each
	Malfunction (*4)	10 to 55 Hz with 0.5-mm single amplitude each in 3 directions for 10 minutes each
Shock resistance	Destruction	300 m/s ² 3 times each in 3 directions
	Malfunction (*4)	200 m/s ² 3 times each in 3 directions
Weight		Approx. 300 g (Cam Positioner main unit only)

*1: Cam output precision, however, is 2° max. for Encoder with 256 resolution (P/R).

*2: All 32-output Models have a maximum of 160 steps total for all cam outputs.

*3: 1000 r/min max. when an E6CP AG5C-C Encoder is connected.

*4: Excluding USB communications.

● Approved Standards

Approved safety standards	cULus (Listing): UL508/CSA C22.2 No. 14	
EMC (*)	(EMI) Emission Enclosure: (EMS) Immunity ESD: Immunity RF-interference: Immunity Conducted Disturbance Immunity Burst: Immunity Surge:	EN61326 EN55011 Group1 Class A EN61326 EN61000-4-2: 4 kV contact discharge 8 kV air discharge EN61000-4-3: 10 V/m (Amplitude-modulated, 80 MHz to 1 GHz) 10 V/m (Pulse-modulated, 900 MHz ± 5 MHz) EN61000-4-6: 10 V (0.15 to 80 MHz) EN61000-4-4: 2 kV for power-line 1 kV for I/O signal-line EN61000-4-5: 1 kV line to line (power line) 2 kV line to ground (power line)

* CE marking does not apply to the USB cable.

Appendix B Troubleshooting

■ Self Diagnostic Function

Display	Meaning	Recovery method
<i>E00</i>	Origin designation data error	Press the CLEAR Key for at least 3 s. All settings, including the origin designation data, will be initialized.
<i>E11</i>	Memory error: RAM error	Cycle the power supply.
<i>E12</i>	Memory error: Checksum error	Press the CLEAR Key for at least 3 s. All settings, including the origin designation data, will be initialized.
<i>E13</i>	CPU error	Cycle the power supply.
<i>E21</i>	Response speed exceeded	The Encoder is rotating faster than the allowable range. Reduce the speed to within the allowable range. Then cycle the power supply or switch to Programming Mode and then to Run Mode.
<i>E22</i>	Encoder data error	This error is output if the encoder resolution setting on the DIP switch does not agree with the resolution of the encoder. Check the setting on the DIP switch and then cycle the power supply.
<i>E23</i>	Encoder resolution inconsistent	Set the Encoder resolution according to the specifications of the Encoder. Then cycle the power supply.
<i>E24</i>	Encoder disconnected	Connect the Encoder connector properly. Then, cycle the power supply or switch to Programming Mode and then to Run Mode.

* If an error occurs, all outputs (including cam, pulse, and run outputs) will be turned OFF.

● About E2□ Errors

In some cases, depending on the encoder resolution and the angle at which the error occurs, it may not be certain which of E21 to E24 has occurred.

If operation cannot be recovered by following the specified recovery method, follow the recovery method for other E2□ errors.

■ Problems during Preparatory Steps/Initial Setting

Symptom	Probable cause	Corrective action
None of indicators is lit.	Power is not supplied correctly.	Check if the power cables are connected to the power supply terminals correctly and also if the power supply voltage is correct.
After turning the power on, all indicators are lit for too a long time.	Power on operation immediately after changing the DIP switch setting (changing the encoder resolution setting)	In this case, the processing time is longer (by approx. 3 seconds) than for normal processing. In normal processing, i.e., when the DIP switch setting has not been changed, the H8PS Cam Positioner starts running after approximately one second.
The display angle does not match the actual angle of the encoder.	The DIP switch resolution setting does not match the resolution of the encoder.	Correct the DIP switch setting (encoder resolution) to match the encoder to be connected. Refer to "3.3.1 Selecting the Encoder Resolution"
An E2□ error suddenly occurs although the encoder is rotating at a low speed.		
Although the DIP switch setting has been changed, the new setting is not effective.	The power has not been cycled.	The H8PS Cam Positioner reads the DIP switch setting when the power is turned on. To make the new setting effective, cycle the power. Refer to "3.3 DIP Switch Setting"
The movement is not smooth although the encoder has been replaced with another with the same resolution	The origin has shifted.	When the encoder is replaced, the origin must be set again. Refer to "3.4 Setting the Origin"
The angle decreases. (The rotation display monitor turns counterclockwise.)	The direction of rotation setting is incorrect.	Set the direction of rotation correctly with the DIP switch. Refer to "3.3.2 Setting the Rotation Direction"
Switching to the function setting mode is not possible.	The programming mode is not selected.	After setting the mode switch to PRGM, hold the [ADV] key down for at least three seconds.
	The bank number display is flashing (16-/32-output models only).	No key operation is accepted while a bank is not identified. Select a bank by pressing the [WRITE] key. Refer to "4.8.3 Designating the Bank Using the Keys"
	The [ADV] key is not held down long enough.	Hold the [ADV] key down for at least three seconds, until "F1" appears in Main display.
Some angle display values are skipped.	A 256 resolution/rotation (360° notation display) encoder is used.	Since the encoder angle is converted to 360° notation to display, some angle values are not displayed. Refer to "Appendix E Angle Data Table (256 Resolution)"

■ Problems in PRGM Mode Operation

Symptom	Probable cause	Corrective action
Some angle display values are skipped.	A 256 resolution/rotation (360° notation display) encoder is used.	Since the encoder angle is converted to 360° notation to display, some angle values are not displayed. Refer to "Appendix E Angle Data Table (256 Resolution)"
Nothing appears in the bank number display area.	The bank function is disabled (16-/32-output models).	Enable the bank function using the F7 menu (bank enable/disable) in the function setting mode. Refer to "4.8.5 Enabling the Bank (F7)"
	An 8-output model is used.	The bank function is available only with 16-/32-output models and is not provided on an 8-output model.
There is no response when the CAM, STEP, or ANGLE key is pressed.	The bank number display is flashing because a bank has not been selected. (16-/32-output models)	No key operation is accepted while a bank is not identified. Select a bank by pressing the [WRITE] key. Refer to "4.8.3 Designating the Bank Using the Keys"
The step number does not increase above a certain value even when the STEP key is pressed.	The step number limit function has been set.	The step number limit function is enabled to prevent setting errors. To change the set limit on the number of steps, use the F5 menu (step number limit) in the function setting mode. Refer to "4.6 Step Number Limit (F5)"
Some cams are not displayed when the CAM key is pressed.	Cam protection is set.	The cam protection function is enabled to stop displaying specific cams in order to prevent setting errors. To change the setting for the cam protection function, use the F6 menu (cam protect) in the function setting mode. Refer to "4.7 Cam Protection (F6)"
Settings are not cleared although the [CLEAR] key is pressed.	The [WRITE] key has not been pressed.	Even if the [CLEAR] key is pressed, clear processing is not executed unless the [WRITE] key is pressed. Pressing the [CLEAR] key simply causes the H8PS Cam Positioner to enter the clear mode. Refer to "3.8 Clearing the Settings"
Moving to the ADV function setting screen is not possible.	The cam display does not show a number in the range No. 1 to No. 7.	ADV function setting is allowed for cam No. 1 to No. 7. Setting is not possible for other cam numbers. Set the ADV function for cam No. 1 to No. 7. Refer to "4.2.2 Specifications of Advance Angle Compensation Function Setting"
The cam number does not increase to No. 8 or a higher number when the CAM key is pressed on the ADV function setting screen.		
"FUL" appears in Main display for one second in response to the pressing of the [WRITE] key. (during programming for a cam with a 32-point model)	An attempt was made to write a program that will exceed the maximum number of steps, which is 160.	Although up to 10 steps can be programmed for each cam, the total number of steps for all cams must not exceed 160. Take appropriate measures to ensure that the programmed number of steps does not exceed 160, such as enabling the pulse output function (refer to "4.4 Pulse Output (F1/F2)").
The E24 error message does not appear although an encoder is disconnected.	The present mode setting is PRGM/MAN.	In the PRGM/MAN mode setting, programming is allowed without connecting an encoder.
	The E24 detection function is disabled.	Enable the function using the F10 menu (E24 detection enable/disable) in the function setting mode. Refer to "4.9 E24 Detection Enable/Disable (F10)"

■ Problems in RUN Mode Operation

Symptom	Probable cause	Corrective action
Some angle display values are skipped.	A 256 resolution/rotation (360° notation display) encoder is used.	Since the encoder angle is converted to 360° notation to display, some angle values are not displayed. Refer to "Appendix E Angle Data Table (256 Resolution)"
Nothing appears in the bank number display area.	The bank function is disabled (16-/32-output models).	Enable the bank function using the F7 menu (bank enable/disable) in the function setting mode. Refer to "4.8.5 Enabling the Bank (F7)"
	An 8-output model is used.	The bank function is available only with 16-/32-output models and is not provided on an 8-output model.
The operation differs from that of the intended program.	The operation is controlled in accordance with a wrong bank.	Check if the active bank number is the one of the programmed (desired) bank.
The step number does not increase above a certain value even when the STEP key is pressed.	The step number limit function has been set.	The step number limit function is enabled to prevent setting errors. To change the set limit on the number of steps, use the F5 menu (step number limit) in the function setting mode. Refer to "4.6 Step Number Limit (F5)"
Some cams are not displayed when the CAM key is pressed.	Cam protection is set.	The cam protection function is enabled to stop displaying specific cams in order to prevent setting errors. To change the setting for the cam protection function, use the F6 menu (cam protection) in the function setting mode. Refer to "4.7 Cam Protection (F6)"
The output ON/OFF timing changes depending on the speed.	An ADV function setting has been made.	Check the ADV function setting of the target cam. Refer to "4.2 Advance Angle Compensation (ADV) Function"
The actual ON/OFF timing differs from the programmed timing.		
The E21 error message appears although the actual speed is lower than the maximum response speed.	An ADV function setting is made for more than four cams.	If ADV function settings are made for more than four cams, the maximum response speed is lowered. If the operation does not allow the speed to be lowered, reduce the number of cams for which an ADV function setting is made. Refer to "4.2 Advance Angle Compensation (ADV) Function"
The speed is not displayed when in run.	Running in the test mode.	In the test mode, the speed is not displayed. To check the speed, run in the RUN mode.

Symptom	Probable cause	Corrective action
The speed/angle display cannot be switched between Main display and Sub-display.	The all protection function is enabled. (OT symbol lights or flashes at the upper right area of the LCD screen.)	The all protection function is enabled to prevent erroneous operation. Refer to "3.11 All Protection Function"
The operation mode does not change from Run Mode to Programming or Test Mode although the mode switch setting is changed.		
Program check is not possible while running.		
OT symbol lights or flashes at the upper right area of the LCD screen.	The all protection function is enabled.	
A program check is not possible although the [CHECK] key is pressed in the RUN mode.	No program has been set.	If the [CHECK] key is pressed while running, only the registered programs are displayed, in sequence.
The cams described below operate differently from the programmed operation. 8-output model: cam No. 7 or 8 16-output model: cam No. 15 or 16 32-output model: cam No. 31 or 32	Speed alarm (upper or lower limit) is allocated.	If Speed alarm is allocated, it has priority over the cam program. Refer to "4.5 Speed Alarm (F3/F4)" Cancel the allocation of Speed alarm, or use other cams.
The RUN output does not turn on. (16-/32-output models)	The start input is not turned on.	The H8PS Cam Positioner is in the output prohibited state (Refer to "4.3 Prohibiting Outputs") unless the start input is turned on. Turn on the start input.
Output does not turn on although a program is set. (16-/32-output models)	The bank input designation is incorrect.	Check if the active bank number is the one of the programmed (desired) bank.
The active bank does not change when the bank input is changed. (16-/32-output models)	Bank input is disabled.	Enable the bank function using the F7 menu (bank enable/disable) in the function setting mode. Refer to "4.8.5 Enabling the Bank (F7)"
	The start input timing is not controlled.	Bank input is switched at the rising edge of the start input. Refer to "4.8.4 Bank Switching Timing" Also, check the timing of start input. Refer to "Appendix D Operation Timing Chart"
	Bank switching method is set at [BANK] key.	To switch the bank with the bank input set so using the F8 menu (selecting the bank switching method) in the function setting mode. Refer to "4.8.6 Selecting the Bank Switching Method (F8)"
The E24 error message does not appear although an encoder is disconnected.	The present mode setting is PRGM/MAN.	In the PRGM/MAN mode setting, programming is allowed without connecting an encoder.
	The E24 detection function is disabled.	Enable the function using the F10 menu (E24 detection enable/disable) in the function setting mode. Refer to "4.9 E24 Detection Enable/Disable (F10)"

Symptom	Probable cause	Corrective action
The E22 error was output even after I checked the setting on the DIP switch and cycled the power supply.	There is noise on a signal line.	Attach ferrite cores to the signal lines. Change the path of the signal lines. Separate the cables from power lines.
	There is noise on the power supply line to the H8PS or encoder.	Attach a ferrite core to power supply line on the AC input or DC output side. Disconnect the FG line. Ground the FG to a different location. Change the path of the power supply line. Separate the cables from power lines.
	The Encoder is faulty.	Replace the Encoder.
An error message (E**) appears.	—	Refer to "Appendix B Troubleshooting"

Appendix C List of Settings

	Setting	RUN	TEST	PRGM	Function setting	Power OFF	Setting range	Factory setting	Refer to (Section No.)
Switch	Mode switch	○	○	○	—	—	PRGM/TEST/RUN	PRGM	3.1
	Programming mode switch	—	○	○	—	—	TCH/MAN	TCH	3.5
DIP switch	No. 1: CW/CCW rotation	—	—	—	—	○	ON (CW)/OFF (CCW)	ON	3.3.2
	No. 2: Not used	—	—	—	—	—	Fixed to ON	ON	—
	No. 3: Resolution	—	—	—	—	○	ON/OFF	ON	3.3.1
	No. 4: Resolution	—	—	—	—	○	ON/OFF	OFF	

	Setting	RUN	TEST	PRGM	Function setting	Power OFF	Setting range	Factory setting	Refer to (Section No.)
Function setting mode	F1: No. of pulse outputs.	—	—	—	○	—	Select from 1, 2, 3, 4, 5, 6, 9, 10, 12, 15, 18, 20, 30, 36, 45, 60, 90 (at 256 resolution/rotation)	60	4.4.1
							Select from 1, 2, 3, 4, 5, 6, 9, 10, 12, 15, 18, 20, 30, 36, 45, 60, 90, 180 (at 360 resolution/rotation)		
							Select from 1, 2, 3, 4, 5, 6, 8, 9, 10, 12, 15, 18, 20, 24, 30, 36, 40, 45, 60, 72, 90, 120, 180, 360 (at 720 resolution/rotation)		
	F2: Pulse output start angle	—	—	—	○	—	0 to 255 (256 resolution/256 display)	0°	4.4.2
							0 to 359° (256 resolution/360 display)		
							0 to 359° (360 resolution)		
							0 to 359.5° (720 resolution)		
	F3: Speed alarm (upper limit)	—	—	—	○	—	"---" or 0 to 1600 (256/360 resolution)	---	4.5.1
							"---" or 0 to 800 (720 resolution)		
	F4: Speed alarm (lower limit)	—	—	—	○	—	"---" or 0 to 1600 (256/360 resolution)	---	4.5.2
"---" or 0 to 800 (720 resolution)									
F5: Step number limit	—	—	—	○	—	1 to 10	10	4.6	
F6: Cam protection	—	—	—	○	—	Enable/disable	Disable	4.7	
F7: Bank enable/disable	—	—	—	○	—	Enable/disable	Disable	4.8.5	
F8: Bank switching method	—	—	—	○	—	in (terminals)/key (BANK key)	in (terminals)	4.8.6	
F9: Bank copy	—	—	—	○	—	—	—	4.8.7	
F10: E24 detection enable/disable	—	—	—	○	—	Enable/disable	Enable	4.9	

	Setting	RUN	TEST	PRGM	Function setting	Power OFF	Setting range	Factory setting	Refer to (Section No.)
Operation	Origin setting	—	○	○	—	—	—	—	3.4
	Cam programming	—	○	○	—	—	—	—	3.5
	Clear	—	○	○	—	—	—	—	3.8
	Checking the setting	○	—	—	—	—	—	—	3.9
	Switch to the function setting mode	—	—	○	—	—	—	—	4.1
	ADV function setting	—	○	○	—	—	—	—	4.2
	Switching the angle and speed display	○	—	—	—	—	Switching Main display (1)/ Sub-display (2)	1: Angle 2: Speed	3.10
	All protection operation	○	—	—	—	—	—	—	3.11
	Bank designation (key)	—	○	○	—	—	—	—	4.8.3
Input	Bank designation (terminal)	○	○	—	—	—	—	—	4.8.2
	Start input	○	○	—	—	—	—	—	Appendix D
	Origin designation input	—	○	○	—	—	—	—	3.4
Output	Cam output	○	○	—	—	—	—	—	Appendix D
	Run output	○	○	—	—	—	—	—	Appendix D
	Pulse output	○	○	—	—	—	—	—	4.4
	Speed alarm output	○	○	—	—	—	—	—	4.5

Appendix D Operation Timing Chart

Relationship between Start Input and Output (bank not used)

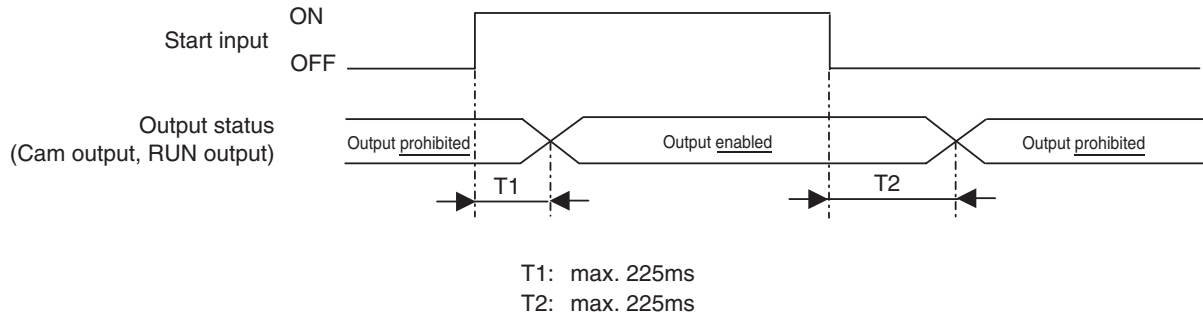

Bank Switching Timing

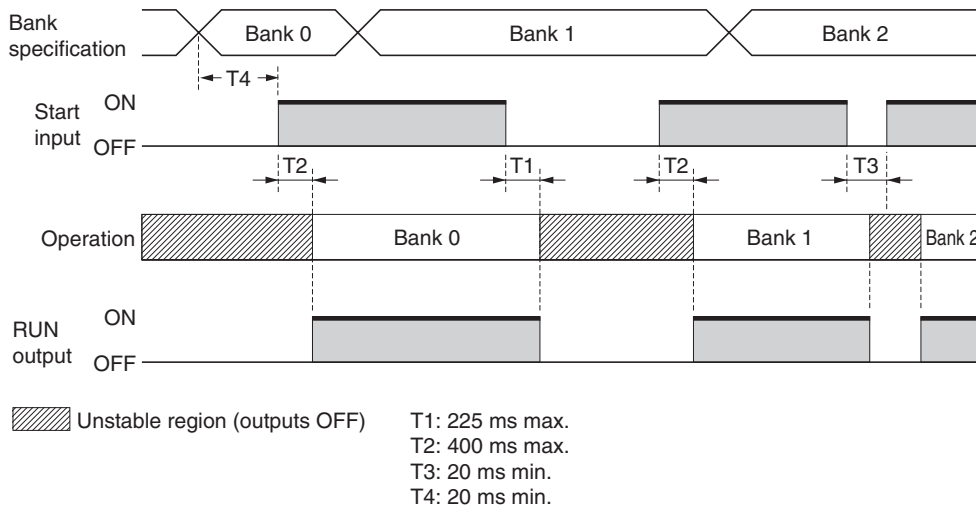

Output Response Time

<Example> ON angle: 28°, OFF angle: 51° (The response time is not influenced by the set angles.)

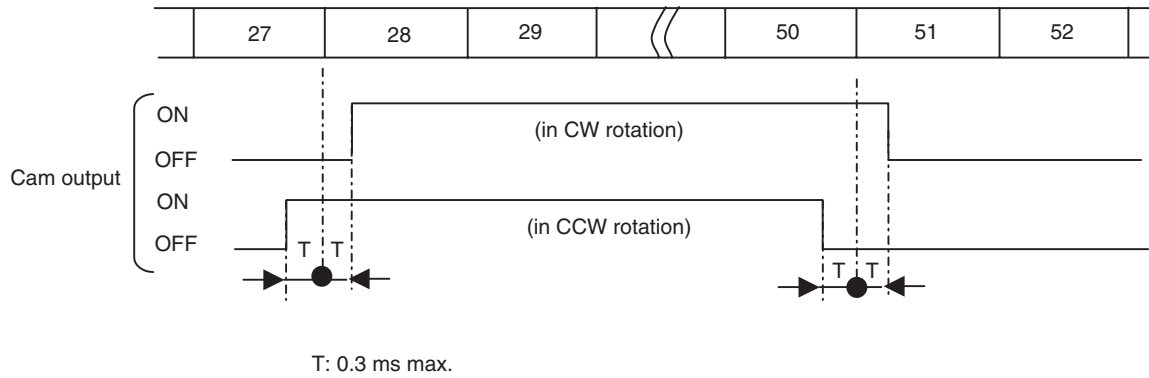

At Power ON/OFF

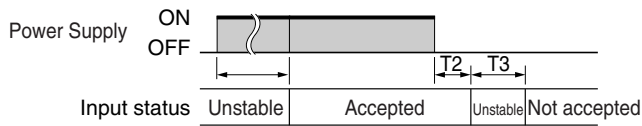

- T1: 1.3 s max. (in normal operation)
3.5 s max. (when the resolution is changed with the DIP switch)
- T2: 5 ms max.
- T3: 1 s max.

Appendix E Angle Data Table (256 Resolution)

■ When a 256 Resolution/rotation Encoder is Used

To assist with programming when using an Encoder with a resolution of 256/rotation, displays and settings may be done by conversion to 360 degrees by setting a pin on the DIP switch inside the front cover. (Refer to "3.3.1 Selecting the Encoder Resolution")

The following table shows the conversions.

Display with 256 resolution	Display in 360° notation	Display with 256 resolution	Display in 360° notation	Display with 256 resolution	Display in 360° notation	Display with 256 resolution	Display in 360° notation	Display with 256 resolution	Display in 360° notation	Display with 256 resolution	Display in 360° notation	Display with 256 resolution	Display in 360° notation	Display with 256 resolution	Display in 360° notation
0	0°	32	45°	64	90°	96	135°	128	180°	160	225°	192	270°	224	315°
1	1°	33	46°	65	91°	97	136°	129	181°	161	226°	193	271°	225	316°
2	3°	34	48°	66	93°	98	138°	130	183°	162	228°	194	273°	226	318°
3	4°	35	49°	67	94°	99	139°	131	184°	163	229°	195	274°	227	319°
4	6°	36	51°	68	96°	100	141°	132	186°	164	231°	196	276°	228	321°
5	7°	37	52°	69	97°	101	142°	133	187°	165	232°	197	277°	229	322°
6	8°	38	53°	70	98°	102	143°	134	188°	166	233°	198	278°	230	323°
7	10°	39	55°	71	100°	103	145°	135	190°	167	235°	199	280°	231	325°
8	11°	40	56°	72	101°	104	146°	136	191°	168	236°	200	281°	232	326°
9	13°	41	58°	73	103°	105	148°	137	193°	169	238°	201	283°	233	328°
10	14°	42	59°	74	104°	106	149°	138	194°	170	239°	202	284°	234	329°
11	15°	43	60°	75	105°	107	150°	139	195°	171	240°	203	285°	235	330°
12	17°	44	62°	76	107°	108	152°	140	197°	172	242°	204	287°	236	332°
13	18°	45	63°	77	108°	109	153°	141	198°	173	243°	205	288°	237	333°
14	20°	46	65°	78	110°	110	155°	142	200°	174	245°	206	290°	238	335°
15	21°	47	66°	79	111°	111	156°	143	201°	175	246°	207	291°	239	336°
16	23°	48	68°	80	113°	112	158°	144	203°	176	248°	208	293°	240	338°
17	24°	49	69°	81	114°	113	159°	145	204°	177	249°	209	294°	241	339°
18	25°	50	70°	82	115°	114	160°	146	205°	178	250°	210	295°	242	340°
19	27°	51	72°	83	117°	115	162°	147	207°	179	252°	211	297°	243	342°
20	28°	52	73°	84	118°	116	163°	148	208°	180	253°	212	298°	244	343°
21	30°	53	75°	85	120°	117	165°	149	210°	181	255°	213	300°	245	345°
22	31°	54	76°	86	121°	118	166°	150	211°	182	256°	214	301°	246	346°
23	32°	55	77°	87	122°	119	167°	151	212°	183	257°	215	302°	247	347°
24	34°	56	79°	88	124°	120	169°	152	214°	184	259°	216	304°	248	349°
25	35°	57	80°	89	125°	121	170°	153	215°	185	260°	217	305°	249	350°
26	37°	58	82°	90	127°	122	172°	154	217°	186	262°	218	307°	250	352°
27	38°	59	83°	91	128°	123	173°	155	218°	187	263°	219	308°	251	353°
28	39°	60	84°	92	129°	124	174°	156	219°	188	264°	220	309°	252	354°
29	41°	61	86°	93	131°	125	176°	157	221°	189	266°	221	311°	253	356°
30	42°	62	87°	94	132°	126	177°	158	222°	190	267°	222	312°	254	357°
31	44°	63	89°	95	134°	127	179°	159	224°	191	269°	223	314°	255	359°

Appendix F Coding Sheet

Bank No. _____

(/)

Cam			Step											Step number limit	Angle advancement setting	
No.	Name	Protection	0	1	2	3	4	5	6	7	8	9				
1			ON													Speed
			OFF													ADV value
2			ON													Speed
			OFF													ADV value
3			ON													Speed
			OFF													ADV value
4			ON													Speed
			OFF													ADV value
5			ON													Speed
			OFF													ADV value
6			ON													Speed
			OFF													ADV value
7			ON													Speed
			OFF													ADV value
8			ON													Speed
			OFF													ADV value
9			ON													Speed
			OFF													ADV value
10			ON													Speed
			OFF													ADV value
11			ON													Speed
			OFF													ADV value
12			ON													Speed
			OFF													ADV value
13			ON													Speed
			OFF													ADV value
14			ON													Speed
			OFF													ADV value
15			ON													Speed
			OFF													ADV value
16			ON													Speed
			OFF													ADV value

F1: Number of output pulses _____

F2: Pulse output start angle _____

F3: Speed alarm (upper limit) _____

F4: Speed alarm (lower limit) _____

APPENDICES

Bank No. _____

(/)

Cam			Step											
No.	Name	Protection		0	1	2	3	4	5	6	7	8	9	Step number limit
17			ON											
			OFF											
18			ON											
			OFF											
19			ON											
			OFF											
20			ON											
			OFF											
21			ON											
			OFF											
22			ON											
			OFF											
23			ON											
			OFF											
24			ON											
			OFF											
25			ON											
			OFF											
26			ON											
			OFF											
27			ON											
			OFF											
28			ON											
			OFF											
29			ON											
			OFF											
30			ON											
			OFF											
31			ON											
			OFF											
32			ON											
			OFF											

F1: Number of output pulses _____

F2: Pulse output start angle _____

F3: Speed alarm (upper limit) _____

F4: Speed alarm (lower limit) _____

Index

Numerics

256 indication 1-11

A

ABS encoder 2-2
 Absolute encoder 2-2
 Advance angle compensation (ADV)
 function 4-4
 Advance indication 1-11
 ADVANCE key 1-12
 All clear 3-17
 All protect indication 1-11
 All protection function 3-20
 Angle advancement 4-4
 Angle data table A-15
 ANGLE keys 1-12
 Angle offset 4-4
 Approved safety standards A-4
 Approved standards A-4

B

Bank copy 4-31
 Bank enable/disable 4-29
 Bank function 4-24
 Bank input 4-25
 BANK key 1-14
 Bank No. display 1-13
 Bank switching method 4-30
 Bank switching timing 4-28

C

CAM keys 1-12
 Cam No. display 1-11
 Cam output display 1-11
 Cam protect 4-23
 Cam switch 1-2
 $\text{C}\checkmark\text{P}\checkmark\text{r}\checkmark\text{d}$ 4-23
 CE marking A-4
 Characteristics A-3
 Chart A-13
 CHECK key 1-12
 Checking the operation timing 3-12
 $\text{C}\checkmark\text{H}\checkmark$ 4-30
 CLEAR 3-15
 clear 3-15
 CLEAR key 1-12
 $\text{C}\checkmark\text{L}\checkmark$ 3-15
 Coding sheet A-16
 Conversion table A-15
 CSA A-4

D

Data table A-15
 Degree of protection A-2
 DIN track mounting base 2-11
 DIP switch 3-5
 Display method A-2

E

E A-5
 $\text{E}\checkmark\text{24}$ 4-32
 E24 Detection enable/disable 4-32
 E69-C□□B 2-18
 E69-DF5 2-19
 EMC A-4
 EN A-4
 Encoder 2-2
 Encoder cable extension distance A-3
 Encoder resolution switch 1-12, 1-13, 1-14
 End plate 2-13
 Error display A-5
 Extension cable 2-19
 Extension distance A-3

F

F1 4-13
 F2 4-14
 F3 4-16
 F4 4-18
 F5 4-20
 F6 4-23
 F7 4-29
 F8 4-30
 F9 4-31
 F10 4-32
 $\text{F}\checkmark$ 4-31
 $\text{F}\checkmark\text{UL}$ 3-8
 Function setting mode 4-2

H

H8PS-SOFT-V1 1-10
 $\text{H}\checkmark$ 4-16

I

Input connections 2-29
 Input reception A-14
 Inrush current VIII

K

Key symbol 3-20

L	List of settings A-10	S	Self diagnostic function A-5
	↳ 4-18		Sensor connection 2-29
M	Main display 1-11		Setting levels 4-2
	Maximum number of steps set 4-20		Setting the ON/OFF angles 3-8
	Mode indicator 1-11		Setting the origin 3-7
	Mode switch 1-12		Shaft coupling 2-18
	Mode transitions 4-2		Spacer 2-13
	Mounting track 2-12		Specifications A-2
N	Nomenclature 1-11		Speed alarm 4-15
	Number of pulses 4-13		Speed alarm (lower limit) 4-18
O	ON/OFF indication 1-11		Speed alarm (upper limit) 4-16
	ON/OFF key 1-12		Start input A-13
	Operation timing chart A-13		Start input indication 1-13
	ORIGIN 3-7		STEP keys 1-12
	Origin designation 3-7		Step No. display 1-11
	Origin input 3-7		↳ 4-20
	ORIGIN key 1-12		↳ 4-14
	Output cable 2-5		Sub-display 1-11
	Output connections 2-30		Support Software 1-10
	Output delay 4-4		Switching the display 3-19
	Output response time A-3, A-14		Switching the display between speed and angle 3-19
P	Parallel input adapters 2-22		System configuration 1-7
	PFP-□ 2-13	T	Table of product models 1-9
	Pin arrangement 2-26		Terminal arrangement 2-25
	↳ 4-13		Tightening torque 1-IV
	Power consumption A-2		Timing chart A-13
	Product models 1-9		↳ 4-31
	Programming mode switch 1-12		Troubleshooting A-5
	Prohibiting outputs 4-11	U	UL A-4
	Protective cover 2-8		Unit indication 1-11
	PULSE OUT (Pulse output) 4-12		Unit ratings A-2
	Pulse output 4-12		Update interval 3-19
	Pulse output start angle 4-14		USB cable 1-10
	PV display 1-11		USB connector 1-14
R	Rated supply voltage A-2		USE 4-29
	Ratings A-2	W	Waterproof cover 2-9
	Refreshing period 4-6		What is cam positioner? 1-2
	Rotation direction 3-6		Wiring table 2-26
	Rotation direction switch 1-12		WRITE key 1-12
	Rotation display 1-11	X	XW2D 2-27
	Rotation meter 4-15		
	RUN OUT (RUN output) A-13		
	RUN output A-13		
	Rush current 2-4		

Y

Y92A-96B 2-8
Y92A-96N 2-9
Y92C-30 2-22
Y92F-91 2-11

OMRON Corporation Industrial Automation Company
Tokyo, JAPAN

Contact: www.ia.omron.com

Regional Headquarters

OMRON EUROPE B.V.

Wegalaan 67-69, 2132 JD Hoofddorp
The Netherlands
Tel: (31)2356-81-300/Fax: (31)2356-81-388

OMRON ELECTRONICS LLC

2895 Greenspoint Parkway, Suite 200
Hoffman Estates, IL 60169 U.S.A
Tel: (1) 847-843-7900/Fax: (1) 847-843-7787

OMRON ASIA PACIFIC PTE. LTD.

No. 438A Alexandra Road # 05-05/08 (Lobby 2),
Alexandra Technopark,
Singapore 119967
Tel: (65) 6835-3011/Fax: (65) 6835-2711

OMRON (CHINA) CO., LTD.

Room 2211, Bank of China Tower,
200 Yin Cheng Zhong Road,
PuDong New Area, Shanghai, 200120, China
Tel: (86) 21-5037-2222/Fax: (86) 21-5037-2200

Authorized Distributor:

© OMRON Corporation 2004. All Rights Reserved.
In the interest of product improvement,
specifications are subject to change without notice.

Cat. No. Z199-E1-02

0415