

Machine Automation Controller

NX-series

Analog I/O Units

User's Manual

for Analog Input Units and Analog Output Units

NX-AD□□□□

NX-DA□□□□

Analog I/O Units

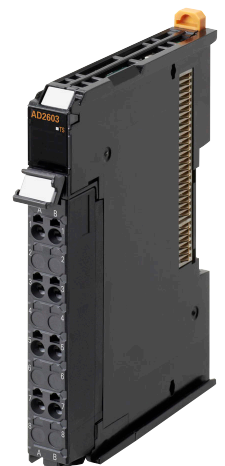



NOTE

All rights reserved. No part of this publication may be reproduced, stored in a retrieval system, or transmitted, in any form, or by any means, mechanical, electronic, photocopying, recording, or otherwise, without the prior written permission of OMRON.

No patent liability is assumed with respect to the use of the information contained herein. Moreover, because OMRON is constantly striving to improve its high-quality products, the information contained in this manual is subject to change without notice. Every precaution has been taken in the preparation of this manual. Nevertheless, OMRON assumes no responsibility for errors or omissions. Neither is any liability assumed for damages resulting from the use of the information contained in this publication.

Trademarks

- Sysmac and SYSMAC are trademarks or registered trademarks of OMRON Corporation in Japan and other countries for OMRON factory automation products.
- Microsoft, Windows, Windows Vista, Excel, and Visual Basic are either registered trademarks or trademarks of Microsoft Corporation in the United States and other countries.
- EtherCAT® is registered trademark and patented technology, licensed by Beckhoff Automation GmbH, Germany.
- Safety over EtherCAT® is registered trademark and patented technology, licensed by Beckhoff Automation GmbH, Germany.
- ODVA, CIP, CompoNet, DeviceNet, and EtherNet/IP are trademarks of ODVA.
- The SD and SDHC logos are trademarks of SD-3C, LLC.  

Other company names and product names in this document are the trademarks or registered trademarks of their respective companies.

Copyrights

Microsoft product screen shots reprinted with permission from Microsoft Corporation.

Introduction

Thank you for purchasing an Analog Input Unit or Analog Output Unit.

This manual contains information that is necessary to use these Analog Input Units and Analog Output Units, which are classified as NX-series Analog I/O Units. Please read this manual and make sure you understand the functionality and performance of the NX-series Analog I/O Unit before you attempt to use it in a control system.

Keep this manual in a safe place where it will be available for reference during operation.

Intended Audience

This manual is intended for the following personnel, who must also have knowledge of electrical systems (an electrical engineer or the equivalent).

- Personnel in charge of introducing FA systems.
- Personnel in charge of designing FA systems.
- Personnel in charge of installing and maintaining FA systems.
- Personnel in charge of managing FA systems and facilities.

For programming, this manual is intended for personnel who understand the programming language specifications in international standard IEC 61131-3 or Japanese standard JIS B 3503.

Applicable Products

This manual covers the following product.

- NX-series Analog Input Units
NX-AD□□□□
- NX-series Analog Output Units
NX-DA□□□□

CONTENTS

Introduction	1
Intended Audience	1
Applicable Products	1
Relevant Manuals	6
Manual Structure	7
Page Structure and Icons	7
Special Information	8
Precaution on Terminology	8
Terms and Conditions Agreement	10
Warranty, Limitations of Liability	10
Application Considerations	11
Disclaimers	11
Safety Precautions	12
Definition of Precautionary Information	12
Symbols	12
Warnings	13
Cautions	14
Precautions for Safe Use	16
Precautions for Correct Use	21
Regulations and Standards	22
Conformance to EU Directives	22
Conformance Requirement to EU Directives	23
Conformance to UL and CSA Standards	23
Conformance to Shipbuilding Standards	23
Conformance to KC Certification	24
Software Licenses and Copyrights	24
Unit Versions	25
Unit Versions	25
Unit Versions and Support Software Versions	26
Related Manuals	27
Terminology	31
Revision History	33
Sections in this Manual	35

Section 1 Features and System Configuration

1-1 Features and Applications	1-2
1-1-1 Features of the Analog Input Units and Analog Output Units	1-2
1-1-2 Applications of the Analog Input Units and Analog Output Units	1-3
1-2 System Configuration	1-4
1-2-1 System Configuration in the Case of a CPU Unit	1-4
1-2-2 System Configuration of Slave Terminals	1-5

1-2-3	System Configuration in the Case of a Communication Control Unit	1-7
1-3	Model List	1-9
1-3-1	Model Notation.....	1-9
1-3-2	Analog Input Units	1-11
1-3-3	Analog Output Units.....	1-13
1-4	List of Functions.....	1-14
1-4-1	Analog Input Units	1-14
1-4-2	Analog Output Units.....	1-15
1-5	Support Software.....	1-16

Section 2 Specifications

2-1	General Specifications	2-2
2-2	Individual Specifications	2-3

Section 3 Part Names and Functions

3-1	Part Names	3-2
3-1-1	Screwless Clamping Terminal Block Type	3-2
3-2	Indicators	3-6
3-2-1	TS Indicator	3-7
3-2-2	Appearance Change of the Indicators	3-8

Section 4 Installation and Wiring

4-1	Installing NX Units	4-2
4-1-1	Installing NX Units	4-2
4-1-2	Attaching Markers.....	4-4
4-1-3	Removing NX Units	4-6
4-1-4	Installation Orientation	4-7
4-2	Power Supply Types and Wiring	4-9
4-2-1	Applications of I/O Power Supply and Supply Methods.....	4-9
4-2-2	Calculating the Total Current Consumption from I/O Power Supply	4-11
4-3	Wiring the Terminals	4-12
4-3-1	Wiring to the Screwless Clamping Terminal Block.....	4-12
4-3-2	Checking the Wiring.....	4-28
4-4	Wiring Examples.....	4-29
4-4-1	Wiring the Analog Input Units	4-29
4-4-2	Wiring the Analog Output Units.....	4-31
4-4-3	Precautions when Using Common Power Supply for Input Devices of Analog Input Units	4-32

Section 5 I/O Refreshing

5-1	I/O Refreshing	5-2
5-1-1	I/O Refreshing from CPU Units to NX Units	5-2
5-1-2	I/O Refreshing from CPU Units or Industrial PCs to Slave Terminal	5-3
5-1-3	I/O Refreshing from the Communication Control Unit to NX Units	5-4
5-1-4	Calculating the I/O Response Times of NX Units	5-5
5-2	I/O Refreshing Methods	5-6
5-2-1	Types of I/O Refreshing Methods	5-6
5-2-2	Setting the I/O Refreshing Methods.....	5-8

5-2-3	Selecting NX Units	5-9
5-2-4	Free-Run Refreshing.....	5-9
5-2-5	Synchronous Input Refreshing.....	5-13
5-2-6	Synchronous Output Refreshing.....	5-17

Section 6 Analog Input Units

6-1	Types of Analog Input Units	6-2
6-2	Input Range and Converted Values	6-4
6-3	Specifications of I/O Data	6-6
6-3-1	Allocable I/O Data	6-6
6-4	List of Settings.....	6-8
6-5	Function	6-12
6-5-1	List of Analog Input Unit Functions.....	6-12
6-5-2	Selecting Channel To Use.....	6-13
6-5-3	Moving Average	6-17
6-5-4	Input Disconnection Detection	6-23
6-5-5	Over Range/Under Range Detection	6-24
6-5-6	User Calibration	6-25

Section 7 Analog Output Units

7-1	Types of Analog Output Units	7-2
7-2	Output Range and Output Set Values.....	7-3
7-3	Specifications of I/O Data	7-5
7-3-1	Allocable I/O Data	7-5
7-4	List of Settings.....	7-6
7-5	Functions	7-9
7-5-1	List of Analog Output Unit Functions.....	7-9
7-5-2	Selecting Channel To Use.....	7-10
7-5-3	Load Rejection Output Setting	7-14
7-5-4	Over Range/Under Range Detection	7-19
7-5-5	User Calibration	7-20

Section 8 Troubleshooting

8-1	How to Check for Errors	8-2
8-2	Checking for Errors with the Indicators	8-3
8-3	Checking for Errors and Troubleshooting on the Support Software.....	8-5
8-3-1	Checking for Errors from the Sysmac Studio.....	8-5
8-3-2	Checking for Errors from Support Software Other Than the Sysmac Studio.....	8-6
8-3-3	Event Codes and Corrections for Errors	8-7
8-3-4	Meaning of Error	8-13
8-4	Resetting Errors	8-35
8-5	Troubles Specific to Each Type of NX Units	8-36
8-5-1	Troubles Common to All Analog Input Units and Analog Output Units.....	8-36
8-5-2	Analog Input Units.....	8-36
8-5-3	Analog Output Units.....	8-37
8-6	Troubleshooting Flowchart	8-38

Section 9 Inspection and Maintenance

9-1	Cleaning and Inspection	9-2
9-1-1	Cleaning.....	9-2
9-1-2	Periodic Inspection	9-2
9-2	Maintenance Procedures	9-5

Appendices

A-1	Data Sheet	A-2
A-1-1	Model List	A-2
A-1-2	Analog Input Units	A-4
A-1-3	Analog Output Units.....	A-24
A-2	Dimensions	A-37
A-2-1	Screwless Clamping Terminal Block Type	A-37
A-3	List of NX Objects.....	A-39
A-3-1	Format of Object Descriptions	A-39
A-3-2	Analog Input Units	A-40
A-3-3	Analog Output Units.....	A-49
A-4	List of Screwless Clamping Terminal Block Models	A-54
A-4-1	Model Notation.....	A-54
A-4-2	List of Terminal Block Models	A-54
A-5	Version Information with CPU Units	A-55
A-5-1	Relationship between Unit Versions of Units	A-55
A-6	Version Information with Communications Coupler Units	A-57
A-6-1	Connection to an EtherCAT Coupler Unit	A-57
A-6-2	Connection to an EtherNet/IP Coupler Unit	A-59
A-7	Version Information with Communication Control Units.....	A-61
A-7-1	Relationship between Unit Versions of Units	A-61
A-8	Displaying the Edit Unit Operation Settings Tab Page	A-63
A-8-1	Connection to the CPU Unit or the Communication Control Unit	A-63
A-8-2	Slave Terminal	A-65

Index

Relevant Manuals

The table below provides the relevant manuals for the NX-series Analog I/O Units.

Read all of the manuals that are relevant to your system configuration and application to make the most of the NX-series Analog I/O Units.

Other manuals, such as related product manuals, are necessary for specific system configurations and applications. Refer to *Related Manuals* on page 27 for the related manuals.

Manual name	Application
NX-series Analog I/O Units User's Manual for Analog Input Units and Analog Output Units ^{*1}	Learning how to use NX-series Analog Input Units and Analog Output Units
NX-series Data Reference Manual	Referencing lists of the data that is required to configure systems with NX-series Units

*1. From revision 05 of this manual, information on the NX-series Temperature Input Units (NX-TS□□□□) that were included in previous revisions was moved to the following manual: *NX-series Analog I/O Units User's Manual for Temperature Input Units and Heater Burnout Detection Units* (Cat. No. W566). Accompanying that change, the name of this manual was changed from the *NX-series Analog I/O Units User's Manual* (Cat. No. W522) to the *NX-series Analog I/O Units User's Manual for Analog Input Units and Analog Output Units* (Cat. No. W522).

Manual Structure

Page Structure and Icons

The following page structure and icons are used in this manual.

The diagram illustrates the structure of a manual page. On the left, annotations identify various elements:

- Level 1 heading:** Points to the main section number '4' at the top right.
- Level 2 heading:** Points to the section title '4-3 Mounting Units'.
- Level 3 heading:** Points to the subsection title '4-3-1 Connecting Controller Components'.
- Page tab:** Points to the small '4' in a dark box on the right margin.
- Special information:** Points to a 'Precautions for Correct Use' icon and text block.
- Manual name:** Points to the footer text 'NJ-series CPU Unit Hardware User's Manual (W500)'.

 On the right, additional annotations explain:

- Level 3 heading:** Gives the current headings.
- Page tab:** Gives the number of the main section.

 The page content includes:

- Section 4: Installation and Wiring
- Section 4-3: Mounting Units
- Section 4-3-1: Connecting Controller Components
- Text: The Units that make up an NJ-series Controller can be connected simply by pressing the Units together and locking the sliders by moving them toward the back of the Units. The End Cover is connected in the same way to the Unit on the far right side of the Controller.
- Step 1: Join the Units so that the connectors fit exactly. Includes a diagram showing 'Hook', 'Connector', and 'Hook holes'.
- Step 2: The yellow sliders at the top and bottom of each Unit lock the Units together. Move the sliders toward the back of the Units as shown below until they click into place. Includes a diagram showing 'Move the sliders toward the back until they lock into place.', 'Release', 'Lock', and 'Slider'.
- Precautions for Correct Use: The sliders on the tops and bottoms of the Power Supply Unit, CPU Unit, I/O Units, Special I/O Units, and CPU Bus Units must be completely locked (until they click into place) after connecting the adjacent Unit connectors.
- Page number: 4-9

Note This illustration is provided only as a sample. It may not literally appear in this manual.

Special Information

Special information in this manual is classified as follows:



Precautions for Safe Use

Precautions on what to do and what not to do to ensure safe usage of the product.



Precautions for Correct Use

Precautions on what to do and what not to do to ensure proper operation and performance.



Additional Information

Additional information to read as required.

This information is provided to increase understanding or make operation easier.



Version Information

Information on differences in specifications and functionality for CPU Units, Industrial PCs, Communications Coupler Units, and Communication Control Units with different unit versions and for different versions of the Support Software is given.

Note References are provided to more detailed or related information.

Precaution on Terminology

- In this manual, “download” refers to transferring data from the Support Software to a physical device and “upload” refers to transferring data from a physical device to the Support Software.
- In this manual, the directions in relation to the Units are given in the following figure, which shows upright installation.

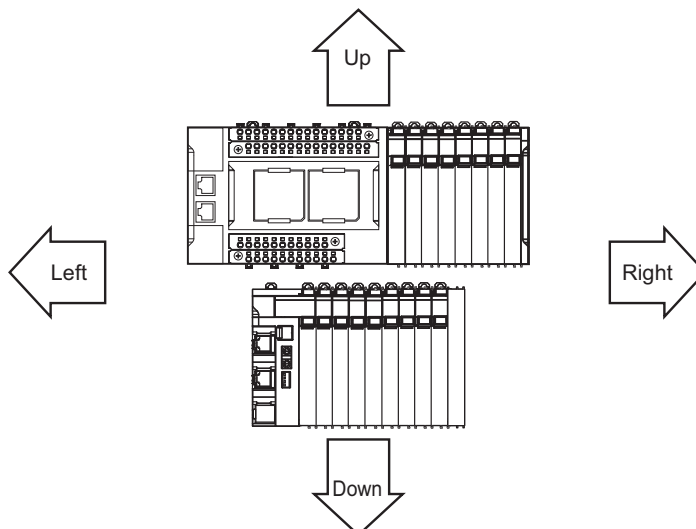

- This user's manual refers to the NY-series IPC Machine Controller Industrial Panel PCs and Industrial Box PCs as simply *Industrial PCs* or as *NY-series Industrial PCs*.

- This user's manual refers to the built-in EtherCAT port on an NJ/NX-series Controller or NY-series Industrial PC as simple a built-in EtherCAT port.
- This user's manual may omit manual names and manual numbers in places that refer to the user's manuals for CPU Units and Industrial PCs. The following table gives some examples. When necessary, refer to *Related Manuals* on page 27 to determine the appropriate manual based on the common text for the omitted contents.

Examples:

Manual name	Omitted contents	Common text
NJ/NX-series CPU Unit Software User's Manual	Software user's manual for the connected CPU Unit or Industrial PC	Software User's Manual
NY-series IPC Machine Controller Industrial Panel PC / Industrial Box PC Software User's Manual		
NJ/NX-series CPU Unit Built-in EtherCAT® Port User's Manual	User's manual for built-in EtherCAT port on the connected CPU Unit or Industrial PC	Built-in EtherCAT port
NY-series IPC Machine Controller Industrial Panel PC / Industrial Box PC Built-in EtherCAT® Port User's Manual		

- This user's manual may omit manual names and manual numbers in places that refer to the user's manuals for Communications Coupler Units. If you use a Communications Coupler Unit, refer to *Related Manuals* on page 27 to identify the manual for your Unit.
- This user's manual may omit manual names and manual numbers in places that refer to the user's manuals for Communication Control Units. If you use a Communication Control Unit, refer to *Related Manuals* on page 27 to identify the manual for your Unit.

Terms and Conditions Agreement

Warranty, Limitations of Liability

Warranties

● Exclusive Warranty

Omron's exclusive warranty is that the Products will be free from defects in materials and workmanship for a period of twelve months from the date of sale by Omron (or such other period expressed in writing by Omron). Omron disclaims all other warranties, express or implied.

● Limitations

OMRON MAKES NO WARRANTY OR REPRESENTATION, EXPRESS OR IMPLIED, ABOUT NON-INFRINGEMENT, MERCHANTABILITY OR FITNESS FOR A PARTICULAR PURPOSE OF THE PRODUCTS. BUYER ACKNOWLEDGES THAT IT ALONE HAS DETERMINED THAT THE PRODUCTS WILL SUITABLY MEET THE REQUIREMENTS OF THEIR INTENDED USE.

Omron further disclaims all warranties and responsibility of any type for claims or expenses based on infringement by the Products or otherwise of any intellectual property right.

● Buyer Remedy

Omron's sole obligation hereunder shall be, at Omron's election, to (i) replace (in the form originally shipped with Buyer responsible for labor charges for removal or replacement thereof) the non-complying Product, (ii) repair the non-complying Product, or (iii) repay or credit Buyer an amount equal to the purchase price of the non-complying Product; provided that in no event shall Omron be responsible for warranty, repair, indemnity or any other claims or expenses regarding the Products unless Omron's analysis confirms that the Products were properly handled, stored, installed and maintained and not subject to contamination, abuse, misuse or inappropriate modification. Return of any Products by Buyer must be approved in writing by Omron before shipment. Omron Companies shall not be liable for the suitability or unsuitability or the results from the use of Products in combination with any electrical or electronic components, circuits, system assemblies or any other materials or substances or environments. Any advice, recommendations or information given orally or in writing, are not to be construed as an amendment or addition to the above warranty.

See <http://www.omron.com/global/> or contact your Omron representative for published information.

Limitation on Liability; Etc

OMRON COMPANIES SHALL NOT BE LIABLE FOR SPECIAL, INDIRECT, INCIDENTAL, OR CONSEQUENTIAL DAMAGES, LOSS OF PROFITS OR PRODUCTION OR COMMERCIAL LOSS IN ANY WAY CONNECTED WITH THE PRODUCTS, WHETHER SUCH CLAIM IS BASED IN CONTRACT, WARRANTY, NEGLIGENCE OR STRICT LIABILITY.

Further, in no event shall liability of Omron Companies exceed the individual price of the Product on which liability is asserted.

Application Considerations

Suitability of Use

Omron Companies shall not be responsible for conformity with any standards, codes or regulations which apply to the combination of the Product in the Buyer's application or use of the Product. At Buyer's request, Omron will provide applicable third party certification documents identifying ratings and limitations of use which apply to the Product. This information by itself is not sufficient for a complete determination of the suitability of the Product in combination with the end product, machine, system, or other application or use. Buyer shall be solely responsible for determining appropriateness of the particular Product with respect to Buyer's application, product or system. Buyer shall take application responsibility in all cases.

NEVER USE THE PRODUCT FOR AN APPLICATION INVOLVING SERIOUS RISK TO LIFE OR PROPERTY OR IN LARGE QUANTITIES WITHOUT ENSURING THAT THE SYSTEM AS A WHOLE HAS BEEN DESIGNED TO ADDRESS THE RISKS, AND THAT THE OMRON PRODUCT(S) IS PROPERLY RATED AND INSTALLED FOR THE INTENDED USE WITHIN THE OVERALL EQUIPMENT OR SYSTEM.

Programmable Products

Omron Companies shall not be responsible for the user's programming of a programmable Product, or any consequence thereof.

Disclaimers

Performance Data

Data presented in Omron Company websites, catalogs and other materials is provided as a guide for the user in determining suitability and does not constitute a warranty. It may represent the result of Omron's test conditions, and the user must correlate it to actual application requirements. Actual performance is subject to the Omron's Warranty and Limitations of Liability.

Change in Specifications

Product specifications and accessories may be changed at any time based on improvements and other reasons. It is our practice to change part numbers when published ratings or features are changed, or when significant construction changes are made. However, some specifications of the Product may be changed without any notice. When in doubt, special part numbers may be assigned to fix or establish key specifications for your application. Please consult with your Omron's representative at any time to confirm actual specifications of purchased Product.

Errors and Omissions

Information presented by Omron Companies has been checked and is believed to be accurate; however, no responsibility is assumed for clerical, typographical or proofreading errors or omissions.



Safety Precautions

Definition of Precautionary Information





The following notation is used in this manual to provide precautions required to ensure safe usage of the NX-series Analog Input Units and Analog Output Units.

The safety precautions that are provided are extremely important to safety. Always read and heed the information provided in all safety precautions.

The following notation is used.

 WARNING	Indicates a potentially hazardous situation which, if not avoided, could result in death or serious injury. Additionally, there may be severe property damage.
 Caution	Indicates a potentially hazardous situation which, if not avoided, may result in minor or moderate injury, or property damage.

Symbols

	The circle and slash symbol indicates operations that you must not do. The specific operation is shown in the circle and explained in text. This example indicates prohibiting disassembly.
	The triangle symbol indicates precautions (including warnings). The specific operation is shown in the triangle and explained in text. This example indicates a precaution for electric shock.
	The triangle symbol indicates precautions (including warnings). The specific operation is shown in the triangle and explained in text. This example indicates a general precaution.
	The filled circle symbol indicates operations that you must do. The specific operation is shown in the circle and explained in text. This example shows a general precaution for something that you must do.

Warnings

WARNING

During Power Supply

Do not touch the terminal section while power is ON.
Electric shock may occur.



Do not attempt to take any Unit apart.

In particular, high-voltage parts are present in Units that supply power while power is supplied or immediately after power is turned OFF. Touching any of these parts may result in electric shock. There are sharp parts inside the Unit that may cause injury.



Fail-safe Measures

Provide safety measures in external circuits to ensure safety in the system if an abnormality occurs due to malfunction of the CPU Unit, Industrial PC, other Units, or slaves or due to other external factors affecting operation.



Not doing so may result in serious accidents due to incorrect operation.

Emergency stop circuits, interlock circuits, limit circuits, and similar safety measures must be provided in external control circuits.



The CPU Unit or Industrial PC will turn OFF all outputs from Output Units in the following cases. The remote I/O slaves will operate according to the settings in the slaves.

- If a power supply error occurs.
- If the power supply connection becomes faulty.
- If a CPU watchdog timer error or CPU reset occurs.
- If a Controller error in the major fault level occurs.
- While the CPU Unit is on standby until RUN mode is entered after the power is turned ON



External safety measures must be provided to ensure safe operation of the system in such cases.

The outputs may remain ON or OFF due to deposition or burning of the output relays or destruction of the output transistors. As a countermeasure for such problems, external safety measures must be provided to ensure safe operation of the system.



If external power supplies for slaves or other devices are overloaded or short-circuited, the voltage will drop, outputs will turn OFF, and the system may be unable to read inputs. Provide external safety measures in control with monitoring of external power supply voltage as required so that the system operates safely in such a case.



You must take fail-safe measures to ensure safety in the event of incorrect, missing, or abnormal signals caused by broken signal lines, momentary power interruptions, or other causes.



Not doing so may result in serious accidents due to incorrect operation.

Voltage and Current Inputs

Make sure that the voltages and currents that are input to the Units and slaves are within the specified ranges.

Inputting voltages or currents that are outside of the specified ranges may cause accidents or fire.



Transferring

Always confirm safety at the destination node before you transfer Unit configuration information, parameters, settings, or other data from tools such as the Sysmac Studio.

The devices or machines may operate unexpectedly, regardless of the operating mode of the Controller.



Cautions

Caution

Wiring

When you connect a computer or other peripheral device to a Communications Coupler Unit that has a non-isolated DC power supply, either ground the 0-V side of the external power supply (i.e. Unit power supply) or do not ground it at all.

If the peripheral devices are grounded incorrectly, the external power supply (i.e. Unit power supply) may be short-circuited.

Never ground the 24-V side of the power supply, as shown in the following figure.

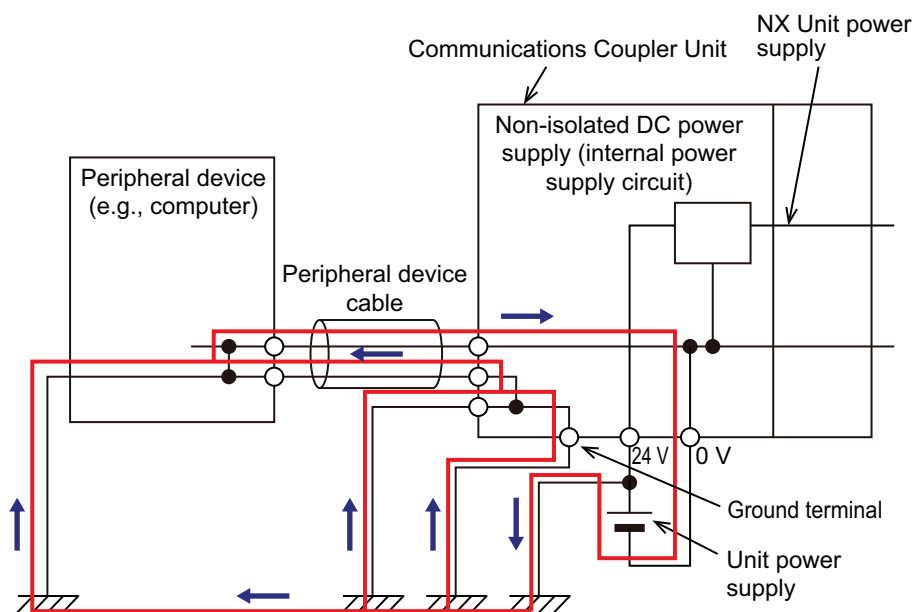

Be sure that all terminal screws and cable connector screws are tightened to the torque specified in the relevant manuals. The loose screws may result in fire or malfunction.



Online Editing

Execute online editing only after confirming that no adverse effects will be caused by deviations in the timing of I/O. If you perform online editing, the task execution time may exceed the task period, I/O may not be refreshed with external devices, input signals may not be read, and output timing may change.



Precautions for Safe Use

Transporting

- When transporting any Unit, use the special packing box for it. Also, do not subject the Unit to excessive vibration or shock during transportation.
- Do not drop any Unit or subject it to abnormal vibration or shock. Doing so may result in Unit malfunction or burning.

Mounting

- Mount terminal blocks and connectors only after checking the mounting location carefully.
- Be sure that the terminal blocks, expansion cables, and other items with locking devices are properly locked into place.

Installation

- Always turn OFF the power supply before installing the Unit. If the power supply is not OFF, the Unit may malfunction or may be damaged.
- Always turn OFF the Unit power supply and I/O power supply before you remove the NX Unit.
- Do not apply labels or tape to the Unit. When the Unit is installed or removed, adhesive or scraps may adhere to the pins in the NX bus connector, which may result in malfunctions.
- Do not touch the pins in the NX bus connector on the Unit. Dirt may adhere to the pins in the NX bus connector, which may result in malfunctions.

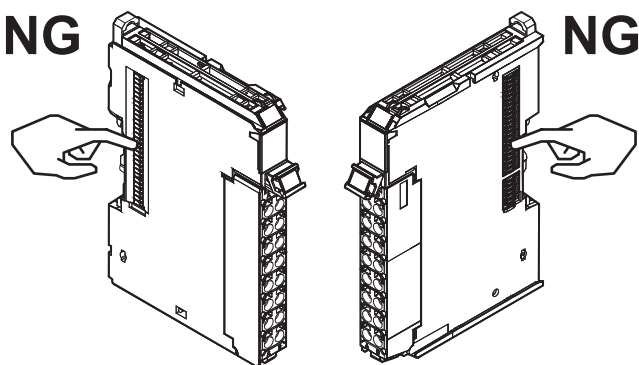

Example: NX Unit (12 mm width)

- Do not write on an NX Unit with ink within the restricted region that is shown in the following figure. Also do not get this area dirty. When the Unit is installed or removed, ink or dirt may adhere to the pins in the NX bus connector, which may result in malfunctions in the CPU Rack or the Slave Terminal.

Refer to the user's manual for the connected CPU Unit, Communications Coupler Unit, or Communication Control Unit for details on the restricted region on the CPU Unit, Communications Coupler Unit, or Communication Control Unit.

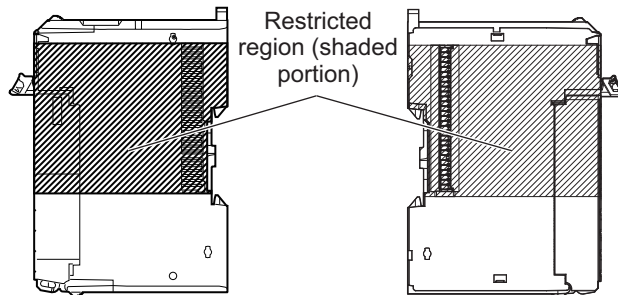

- For the installation orientations in the following figure, support the cables, e.g., with a duct, so that the End Plate on the bottom is not subjected to the weight of the cables. The weight of the cables may cause the bottom End Plate to slide downward so that the Slave Terminal is no longer secured to the DIN Track, which may result in malfunctions.

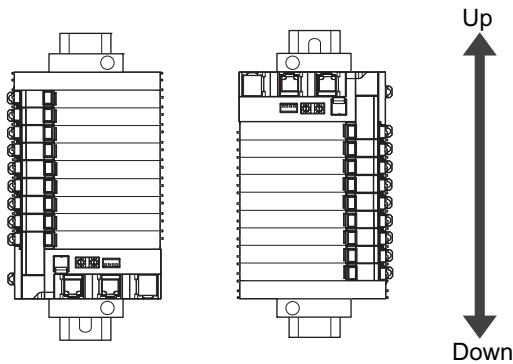

Wiring

- Double-check all switches and other settings and double-check all wiring to make sure that they are correct before turning ON the power supply.
Use the correct wiring parts and tools when you wire the system.
- Do not pull on the cables or bend the cables beyond their natural limit. Also, do not place heavy objects on top of the cables or other wiring lines. Doing so may break the cable.
- When wiring or installing the Units, do not allow metal fragments to enter the Units.
- Do not press the flat-blade screwdriver straight into the release holes on a screwless clamping terminal block. Doing so may damage the terminal block.

NG

OK

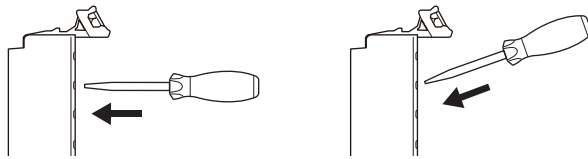

- When you insert a flat-blade screwdriver into a release hole on a screwless clamping terminal block, press it down with a force of 30N or less. Applying excessive force may damage the terminal block.
- Do not incline or twist the flat-blade screwdriver while it is in a release hole on a screwless clamping terminal block. Doing so may damage the terminal block.

NG

NG



- Use crimp terminals for wiring the M3 screw terminal blocks. Do not connect bare stranded wires directly to the M3 screw terminal blocks.

Power Supply Design

- Use all Units within the I/O power supply ranges that are given in the specifications.
- The I/O power supply current for the CPU Rack with an NX-series CPU Unit should be within the range specified for the CPU Unit model. For example, use the NX1P2 CPU Unit with a current of 4 A or less. Using the currents that are outside of the specifications may cause failure or damage. Refer to the user's manual for the connected CPU Unit for the I/O power supply current for the CPU Unit model.
- Supply sufficient power according to the contents of this manual.
- Use the power supply voltage that is specified in this manual.
- Do not apply voltages that exceed the rated value to any Input Unit.
- Do not apply voltages or connect loads to the Output Units or slaves in excess of the maximum ratings.
- Inrush current occurs when the power supply is turned ON. When selecting fuses or breakers for external circuits, consider their fusing and detection characteristics as well as the above precautions and allow sufficient margin in shut-off performance.
- Install external breakers and take other safety measures against short-circuiting and overcurrents in external wiring.

Turning ON the Power Supply

- When you set the Operating Mode at Startup, confirm that no adverse effect will occur in the system.

Actual Operation

- Before you start operation, always register the NX Units that are connected to the Communications Coupler Unit in the host communications master as the Unit Configuration Information.
- Check the user program, data, and parameter settings for proper execution before you use them for actual operation.
- If you change the fail-soft operation setting, the output status when the error occurs may also change. Confirm safety before you change the fail-soft operation setting.
- If you use fail-soft operation, write programming to determine whether Unit I/O data is valid. Without such programming, the user program cannot distinguish between Units for which I/O refreshing is continued and Units for which I/O refreshing is stopped.

Turning OFF the Power Supply

- Do not disconnect the cable or turn OFF the power supply to the Controller or a Slave Terminal when downloading data or the user program from the Support Software.
- Always turn OFF the external power supply to the Units before attempting any of the following.
 - Mounting or removing an NX Unit, Communications Coupler Unit, CPU Unit, Industrial PC, or Communication Control Unit
 - Setting DIP switches or rotary switches
 - Connecting or wiring cables
 - Attaching or removing terminal blocks or connectors
 Units that supply power continue to supply power to the Units for up to several seconds after the power supply is turned OFF. The PWR indicator remains lit as long as power is supplied. Confirm that the PWR indicator is not lit before you perform any of the above.

Operation

- Confirm that the controlled system will not be adversely affected before you perform any of the following operations.
 - Changing the operating mode of the CPU Unit or the Industrial PC (including changing the setting of the Operating Mode at Startup)
 - Changing the user program or settings
 - Changing set values or present values
 - Forced refreshing
- Always sufficiently check the safety at the connected devices before you change the settings of a slave or Unit.

General Communications

- Do not exceed the ranges that are given in the specifications for the communications distance and number of connected Units.
- Refer to the user's manual for the Communications Coupler Unit for precautions for the safe use of communications with the connected Communications Coupler Unit.

Unit Replacement

- When you replace a Unit, start operation only after you transfer the settings and variables that are required for operation to the new Unit.

Disposal

- Dispose of the product according to local ordinances as they apply.

Precautions for Correct Use

Storage, Mounting, and Wiring

- Follow the instructions in this manual to correctly perform installation and wiring.
- Do not operate or store the Units in the following locations. Doing so may result in malfunction, in operation stopping, or in burning.
 - Locations subject to direct sunlight
 - Locations subject to temperatures or humidity outside the range specified in the specifications
 - Locations subject to condensation as the result of severe changes in temperature
 - Locations subject to corrosive or flammable gases
 - Locations subject to dust (especially iron dust) or salts
 - Locations subject to exposure to water, oil, or chemicals
 - Locations subject to shock or vibration
- Take appropriate and sufficient countermeasures during installation in the following locations.
 - Locations subject to strong, high-frequency noise
 - Locations subject to static electricity or other forms of noise
 - Locations subject to strong electromagnetic fields
 - Locations subject to possible exposure to radioactivity
 - Locations close to power lines
- Before touching a Unit, be sure to first touch a grounded metallic object in order to discharge any static build-up.
- Use the rated power supply voltage for the Units that supply power. Take appropriate measures to ensure that the specified power with the rated voltage and frequency is supplied in places where the power supply is unstable.
- Install the Units away from sources of heat and ensure proper ventilation. Not doing so may result in malfunction, in operation stopping, or in burning.
- Do not allow foreign matter to enter the openings in the Unit. Doing so may result in Unit burning, electric shock, or failure.

Actual Operation

- If you change the event level of an error, the output status when the error occurs may also change. Confirm safety before you change an event level.

Turning OFF the Power Supply

- Do not turn OFF the power supply while data is being transferred.
- Do not turn OFF the power supply while parameters are being written to the CPU Unit, the Communications Coupler Unit, Communication Control Unit, or NX Units.

General Communications

- Refer to the user's manual for the Communications Coupler Unit for precautions for the correct use of communications with the connected Communications Coupler Unit.
- Refer to the user's manual for the Communication Control Unit for precautions for the correct use of communications with the connected Communication Control Unit.

Regulations and Standards

Conformance to EU Directives

Applicable Directives

- EMC Directives
- Low Voltage Directive

Concepts

● EMC Directives

OMRON devices that comply with EU Directives also conform to the related EMC standards so that they can be more easily built into other devices or the overall machine. The actual products have been checked for conformity to EMC standards.*1

Whether the products conform to the standards in the system used by the customer, however, must be checked by the customer. EMC-related performance of the OMRON devices that comply with EU Directives will vary depending on the configuration, wiring, and other conditions of the equipment or control panel on which the OMRON devices are installed. The customer must, therefore, perform the final check to confirm that devices and the overall machine conform to EMC standards.

*1. Applicable EMC (Electromagnetic Compatibility) standards are as follows:

EMS (Electromagnetic Susceptibility): EN 61131-2

EMI (Electromagnetic Interference): EN 61131-2 (Radiated emission: 10-m regulations).

● Low Voltage Directive

Always ensure that devices operating at voltages of 50 to 1,000 VAC and 75 to 1,500 VDC meet the required safety standards. The applicable directive is EN 61010-2-201.

● Conformance to EU Directives

The NX-series Units comply with EU Directives. To ensure that the machine or device in which the NX-series Units are used complies with EU Directives, the following precautions must be observed.

- The NX-series Units must be installed within a control panel.
- You must use SELV power supply for the DC power supplies that are connected as the Unit power supplies and I/O power supplies for the NX-series Units.

EMC standard compliance was confirmed for the recommended Power Supplies. Refer to the user's manual for the connected CPU Unit for the recommended power supplies for the CPU Rack with an NX-series CPU Unit. Refer to the user's manual for the connected Communications Coupler Unit for the recommended power supplies for the Slave Terminal. Refer to the user's manual for the connected Communication Control Unit for the recommended power supplies for the CPU Rack with an NX-series Communication Control Unit.

- NX-series Units that comply with EU Directives also conform to the Common Emission Standard (EN 61131-2). Radiated emission characteristics (10-m regulations) may vary depending on the configuration of the control panel used, other devices connected to the control panel, wiring, and other conditions.

You must therefore confirm that the overall machine or equipment in which the NX-series Units are used complies with EU Directives.

- You must use power supplies with an output hold time of 10 ms or longer for the DC power supplies that are connected as the Unit power supplies and I/O power supplies for the NX-series Units.
- This is a Class A product (for industrial environments). In a residential environment, it may cause radio interference. If radio interference occurs, the user may be required to take appropriate measures.

Conformance Requirement to EU Directives

The immunity test conditions for the NX-series Analog Input Units and Analog Output Units are as follows:

Unit Type	Conversion time	Overall accuracy
Analog Input Units	250 μ s/point	+3% / -6%
	10 μ s/point	+6% / -6%
Analog Output Units	250 μ s/point	+4% / -4%
	10 μ s/point	+4.5% / -4.5%

Use a shield wire (2 conductors, twisted wire) or a shield wire (3 conductors) to connect the Analog Input Units and Analog Output Units. The compatibility was confirmed in a condition that the shield wire was not connected.

Conformance to UL and CSA Standards

Some NX-series products comply with UL and CSA standards. If you use an NX-series product that complies with UL or CSA standards and the machinery or system in which you use the NX-series product must also comply with the standards, refer to the *Instruction Sheet* that is provided with the product. The *Instruction Sheet* provides the application conditions for complying with the standards.

Conformance to Shipbuilding Standards

Some NX-series products comply with shipbuilding standards. If you use an NX-series product that complies with shipbuilding standards and the machinery or system in which you use the NX-series product must also comply with the standards, consult with your OMRON representative. Application conditions are defined according to the installation location. Application may not be possible for some installation locations.

For shipbuilding standard usage conditions, refer to *Conformance to Shipbuilding Standards* in the user's manual for the CPU Unit, Communications Coupler Unit, or Communication Control Unit that the NX Units are connected to.

Note that the usage conditions are provided in the relevant user's manuals for Units whose conformance to shipbuilding standards is confirmed.

Conformance to KC Certification

Observe the following precaution if you use NX-series Units in Korea.

A급 기기 (업무용 방송통신기자재)
이 기기는 업무용(A급) 전자파적합기기로서 판매자
또는 사용자는 이 점을 주의하시기 바라며, 가정외의
지역에서 사용하는 것을 목적으로 합니다.

Class A Device (Broadcasting Communications Device for Office Use)

This device obtained EMC registration for office use (Class A), and it is intended to be used in places other than homes.

Sellers and/or users need to take note of this.

Software Licenses and Copyrights

This product incorporates certain third party software. The license and copyright information associated with this software is available at http://www.fa.omron.co.jp/nj_info_e/.

Unit Versions

This section describes the notation that is used for unit versions, the confirmation method for unit versions, and the relationship between unit versions and Support Software versions.

Unit Versions

A “unit version” has been introduced to manage the Units in the NX Series according to differences in functionality accompanying Unit upgrades.

An example is provided below for Communications Coupler Units and NX Units. Refer to the user’s manual for each Unit for details on the version notation and the method for checking version information of the CPU Units, Industrial PCs, and Communication Control Units.

Notation of Unit Versions on Products

The unit version is given with the Unit specifications on the side of the Unit or in the notched area.

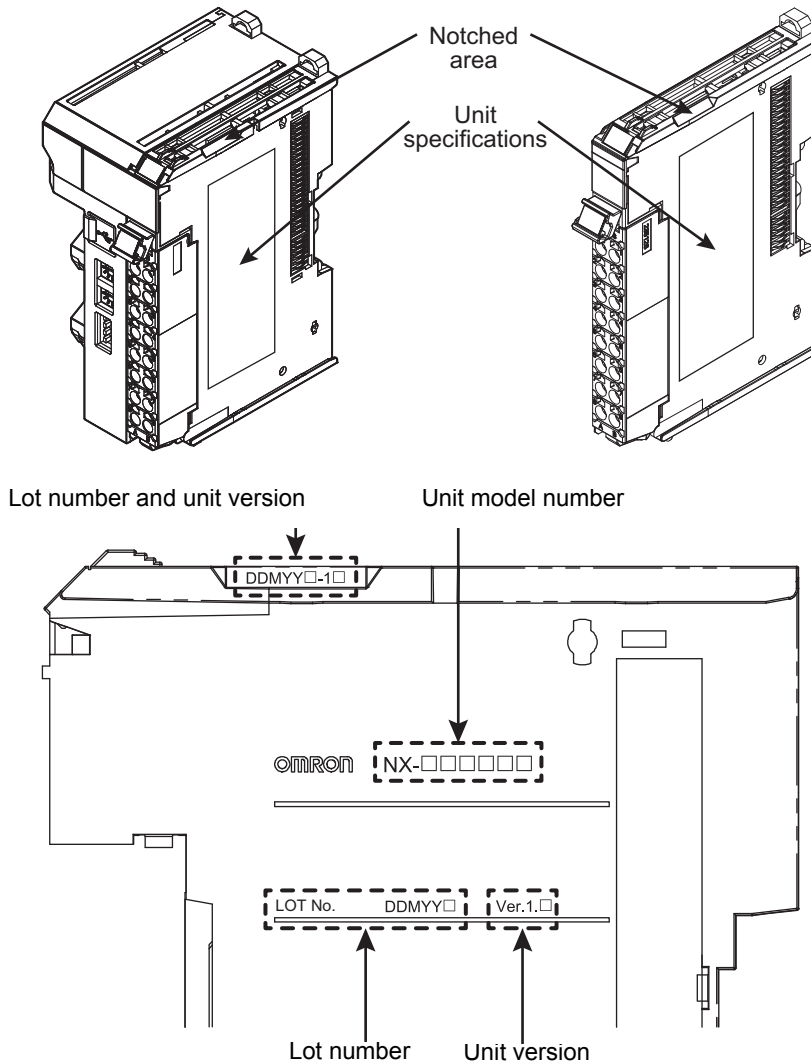

The following information is provided in the Unit specifications on the Unit.

Name	Function
Unit model number	Gives the model of the Unit.
Unit version	Gives the unit version of the Unit.
Lot number	Gives the lot number of the Unit. DDMY□□: Lot number, □: Used by OMRON. “M” gives the month (1 to 9: January to September, X: October, Y: November, Z: December)

The following information is provided in the notched area on the Unit.

Name	Function
Lot number and unit version	Gives the lot number and unit version of the Unit. <ul style="list-style-type: none"> • DDMY□□: Lot number, □: Used by OMRON. “M” gives the month (1 to 9: January to September, X: October, Y: November, Z: December) • 1□: Unit version The decimal portion of the unit version is omitted. (It is provided in the Unit specifications.)

Confirming Unit Versions with the Support Software

If your NX Unit is connected to a CPU Unit, refer to the user’s manual of the connected CPU Unit for the confirmation method for the unit version of the NX Unit.

If your NX Unit is connected to a Communications Coupler Unit, refer to the user’s manual of the connected Communications Coupler Unit for the confirmation method for the unit version of the Communications Coupler Unit and NX Unit.

If your NX Unit is connected to a Communication Control Unit, refer to the user’s manual of the connected Communication Control Unit for the confirmation method for the unit version of the NX Unit.

Unit Versions and Support Software Versions

The functions that are supported depend on the unit version of the Unit. The version of Support Software that supports the functions that were added for an upgrade is also required to use those functions.

Depending on the Unit to which the NX Unit is connected, refer to the following appendices for the functions that are supported by each unit version.

A-5 Version Information with CPU Units on page A-55

A-6 Version Information with Communications Coupler Units on page A-57

A-7 Version Information with Communication Control Units on page A-61

Related Manuals

The following table shows related manuals. Use these manuals for reference.

Manual name	Cat. No.	Model numbers	Application	Description
NX-series Analog I/O Units User's Manual for Analog Input Units and Analog Output Units*1	W522	NX-AD□□□□ NX-DA□□□□	Learning how to use NX-series Analog Input Units and Analog Output Units	The hardware, setup methods, and functions of the NX-series Analog Input Units and Analog Output Units are described.
NX-series Data Reference Manual	W525	NX-□□□□□□	Referencing lists of the data that is required to configure systems with NX-series Units	Lists of the power consumptions, weights, and other NX Unit data that is required to configure systems with NX-series Units are provided.
NX-series System Units User's Manual	W523	NX-PD1□□□ NX-PF0□□□ NX-PC0□□□ NX-TBX01	Learning how to use NX-series System Units	The hardware and functions of the NX-series System Units are described.
Sysmac Studio Version 1 Operation Manual	W504	SYSMAC-SE2□□□	Learning about the operating procedures and functions of the Sysmac Studio	Describes the operating procedures of the Sysmac Studio.
NX-IO Configurator Operation Manual	W585	CXONE-AL□□D-V4	Learning about the operating procedures and functions of the NX-IO Configurator.	Describes the operating procedures of the NX-IO Configurator.
NJ/NX-series Troubleshooting Manual	W503	NX701-□□□□ NJ501-□□□□ NJ301-□□□□ NJ101-□□□□ NX102-□□□□ NX1P2-□□□□	Learning about the errors that may be detected in an NJ/NX-series Controller	Concepts on managing errors that may be detected in an NJ/NX-series Controller and information on individual errors are described.
NY-series Troubleshooting Manual	W564	NY532-□□□□ NY512-□□□□	Learning about the errors that may be detected in an NY-series Industrial PC	Concepts on managing errors that may be detected in an NY-series Controller and information on individual errors are described.
NX-series EtherCAT® Coupler Unit User's Manual	W519	NX-ECC20□	Learning how to use an NX-series EtherCAT Coupler Unit and EtherCAT Slave Terminals	The following items are described: the overall system and configuration methods of an EtherCAT Slave Terminal (which consists of an NX-series EtherCAT Coupler Unit and NX Units), and information on hardware, setup, and functions to set up, control, and monitor NX Units through EtherCAT.

Manual name	Cat. No.	Model numbers	Application	Description
NX-series Ether-Net/IP™ Coupler Unit User's Manual	W536	NX-EIC202	Learning how to use an NX-series EtherNet/IP Coupler Unit and EtherNet/IP Slave Terminals	The following items are described: the overall system and configuration methods of an EtherNet/IP Slave Terminal (which consists of an NX-series EtherNet/IP Coupler Unit and NX Units), and information on hardware, setup, and functions to set up, control, and monitor NX Units.
NX-series CPU Unit Hardware User's Manual	W535	NX701-□□□□	Learning the basic specifications of the NX-series NX701 CPU Units, including introductory information, designing, installation, and maintenance. Mainly hardware information is provided.	An introduction to the entire NX701 CPU Unit system is provided along with the following information on the CPU Unit. <ul style="list-style-type: none"> • Features and system configuration • Overview • Part names and functions • General specifications • Installation and wiring • Maintenance and Inspection
NX-series NX102 CPU Unit Hardware User's Manual	W593	NX102-□□□□	Learning the basic specifications of the NX-series NX102 CPU Units, including introductory information, designing, installation, and maintenance. Mainly hardware information is provided.	An introduction to the entire NX102 CPU Unit system is provided along with the following information on the CPU Unit. <ul style="list-style-type: none"> • Features and system configuration • Overview • Part names and functions • General specifications • Installation and wiring • Maintenance and inspection
NX-series NX1P2 CPU Unit Hardware User's Manual	W578	NX1P2-□□□□	Learning the basic specifications of the NX-series NX1P2 CPU Units, including introductory information, designing, installation, and maintenance. Mainly hardware information is provided.	An introduction to the entire NX1P2 CPU Unit system is provided along with the following information on the CPU Unit. <ul style="list-style-type: none"> • Features and system configuration • Overview • Part names and functions • General specifications • Installation and wiring • Maintenance and Inspection
NJ-series CPU Unit Hardware User's Manual	W500	NJ501-□□□□ NJ301-□□□□ NJ101-□□□□	Learning the basic specifications of the NJ-series CPU Units, including introductory information, designing, installation, and maintenance. Mainly hardware information is provided.	An introduction to the entire NJ-series system is provided along with the following information on the CPU Unit. <ul style="list-style-type: none"> • Features and system configuration • Overview • Part names and functions • General specifications • Installation and wiring • Maintenance and Inspection <p>Use this manual together with the <i>NJ-series CPU Unit Software User's Manual</i> (Cat. No. W501).</p>

Manual name	Cat. No.	Model numbers	Application	Description
NY-series IPC Machine Controller Industrial Panel PC Hardware User's Manual	W557	NY532-□□□□	Learning the basic specifications of the NY-series Industrial Panel PCs, including introductory information, designing, installation, and maintenance. Mainly hardware information is provided.	An introduction to the entire NY-series system is provided along with the following information on the Industrial Panel PC. <ul style="list-style-type: none"> • Features and system configuration • Introduction • Part names and functions • General specifications • Installation and wiring • Maintenance and inspection
NY-series IPC Machine Controller Industrial Box PC Hardware User's Manual	W556	NY512-□□□□	Learning the basic specifications of the NY-series Industrial Box PCs, including introductory information, designing, installation, and maintenance. Mainly hardware information is provided.	An introduction to the entire NY-series system is provided along with the following information on the Industrial Box PC. <ul style="list-style-type: none"> • Features and system configuration • Introduction • Part names and functions • General specifications • Installation and wiring • Maintenance and inspection
NJ/NX-series CPU Unit Software User's Manual	W501	NX701-□□□□ NJ501-□□□□ NJ301-□□□□ NJ101-□□□□ NX102-□□□□ NX1P2-□□□□	Learning how to program and set up an NJ/NX-series CPU Unit. Mainly software information is provided.	The following information is provided on an NJ/NX-series CPU Unit. <ul style="list-style-type: none"> • CPU Unit operation • CPU Unit features • Initial settings • Programming based on IEC 61131-3 language specifications
NY-series IPC Machine Controller Industrial Panel PC / Industrial Box PC Software User's Manual	W558	NY532-□□□□ NY512-□□□□	Learning how to program and set up the Controller functions of an NY-series Industrial PC	The following information is provided on NY-series Machine Automation Control Software. <ul style="list-style-type: none"> • Controller operation • Controller features • Controller settings • Programming based on IEC 61131-3 language specifications
NJ/NX-series CPU Unit Built-in EtherCAT® Port User's Manual	W505	NX701-□□□□ NJ501-□□□□ NJ301-□□□□ NJ101-□□□□ NX102-□□□□ NX1P2-□□□□	Using the built-in EtherCAT port on an NJ/NX-series CPU Unit	Information on the built-in EtherCAT port is provided. This manual provides an introduction and provides information on the configuration, features, and setup.
NY-series IPC Machine Controller Industrial Panel PC / Industrial Box PC Built-in EtherCAT® Port User's Manual	W562	NY532-□□□□ NY512-□□□□	Using the built-in EtherCAT port on an NY-series Industrial PC	Information on the built-in EtherCAT port is provided. This manual provides an introduction and provides information on the configuration, features, and setup.

Manual name	Cat. No.	Model numbers	Application	Description
NJ/NX-series Instructions Reference Manual	W502	NX701-□□□□ NJ501-□□□□ NJ301-□□□□ NJ101-□□□□ NX102-□□□□ NX1P2-□□□□	Learning detailed specifications on the basic instructions of an NJ/NX-series CPU Unit	The instructions in the instruction set (IEC 61131-3 specifications) are described.
NY-series Instructions Reference Manual	W560	NY532-□□□□ NY512-□□□□	Learning detailed specifications on the basic instructions of an NY-series Industrial PC	The instructions in the instruction set (IEC 61131-3 specifications) are described.
NX-series Safety Control Unit / Communication Control Unit User's Manual	Z395	NX-SL5□□□ NX-SI□□□□ NX-SO□□□□ NX-CSG□□□	Learning how to use the NX-series Safety Control Units and Communication Control Units.	Describes the hardware, setup methods, and functions of the NX-series Safety Control Units and Communication Control Units.

*1. From revision 05 of this manual, information on the NX-series Temperature Input Units (NX-TS□□□□) that were included in previous revisions was moved to the following manual: *NX-series Analog I/O Units User's Manual for Temperature Input Units and Heater Burnout Detection Units* (Cat. No. W566). Accompanying that change, the name of this manual was changed from the *NX-series Analog I/O Units User's Manual* (Cat. No. W522) to the *NX-series Analog I/O Units User's Manual for Analog Input Units and Analog Output Units* (Cat. No. W522).

Terminology

Term	Abbreviation	Description
application layer status, AL status	---	Status for indicating information on errors that occur in an application on a slave.
CAN application protocol over EtherCAT	CoE	A CAN application protocol service implemented on EtherCAT.
CAN in Automation	CiA	CiA is the international users' and manufacturers' group that develops and supports higher-layer protocols.
Communication Control Unit		An interface unit for CIP Safety communications between a Safety CPU Unit and a CIP Safety on EtherNet/IP device on a network.
Communications Coupler Units	---	The generic name of an interface unit for remote I/O communications on a network between NX Units and a host network master.
CPU Rack	---	A Rack to which a CPU Unit or Communication Control Unit is mounted. For NX-series CPU Units to which NX Units can be connected, a CPU Rack has a CPU Unit with NX Units and an End Cover mounted to it. For NX-series Communication Control Units, a CPU Rack has a Communication Control Unit with NX Units and an End Cover mounted to it.
DC time	---	In a CPU Rack of a NX-series CPU Unit to which NX Units can be connected, time indicated by the clock shared between the CPU Unit and the NX Units. EtherCAT slaves that support distributed clock synchronization have a clock that is shared by all slaves in the network. The time that is based on this distributed clock is called the DC time. The same clock is shared by a CPU Unit, NX Units connected to the CPU Unit, and applicable EtherCAT slaves.
device profile	---	A collection of device dependent information and functionality providing consistency between similar devices of the same device type.
device variable	---	A variable that is used to access a specific device through an I/O port by an NJ/NX-series CPU Unit or NY-series Industrial PC. Process data on an EtherCAT slave is allocated to this variable. For NX-series CPU Units to which NX Units can be connected, I/O data for the NX Units on a CPU Unit is allocated. A user application on a CPU Unit or Industrial PC accesses a device that can be connected, by directly reading and writing this device variable.
distributed clock	DC	Clock distribution mechanism used to synchronize EtherCAT slaves and the EtherCAT master.
EtherCAT slave controller	ESC	A controller for EtherCAT slave communications.
EtherCAT slave information	ESI	An XML file that contains setting information for an EtherCAT slave.
EtherCAT state machine	ESM	An EtherCAT communications state machine.
EtherCAT Technology Group	ETG	The ETG is a global organization in which OEM, end users, and technology providers join forces to support and promote the further technology development.
I/O map settings	---	Settings that assign variables to I/O ports. Assignment information between I/O ports and variables.
I/O port	---	A logical interface that is used by the NJ/NX-series CPU Unit or NY-series Industrial PC to exchange data with an external device (slave or Unit).
I/O refreshing	---	Cyclic data exchange with external devices that is performed with predetermined memory addresses.
index	---	Address of an object within an application process.
network configuration information	---	The EtherCAT network configuration information held by the EtherCAT master.

Term	Abbreviation	Description
NX bus	---	The NX-series internal bus.
object	---	An abstract representation of a particular component within a device, which consists of data, parameters, and methods.
object dictionary	OD	Data structure that contains description of data type objects, communication objects and application objects.
Operational	---	A state in which I/O refresh communications and NX message communications are possible between the communications master and the Communications Coupler Unit or NX Units.
PDO communications	---	An acronym for process data communications.
Pre-Operational	---	A state in which NX message communications are possible between the communications master and the Communications Coupler Unit or NX Units, but I/O refresh communications are not possible.
primary periodic task	---	The task with the highest priority.
process data	---	Collection of application objects designated to be downloaded cyclically or acyclically for the purpose of measurement and control.
process data communications	---	One type of EtherCAT communications in which process data objects (PDOs) are used to exchange information cyclically and in realtime. This is also called PDO communications.
process data object	PDO	A structure that describes the mappings of parameters that have one or more process data entities.
receive PDO	RxPDO	A process data object received by an EtherCAT slave.
Safe-Operational	---	A state in which input refresh communications and NX message communications are possible between the communications master and the Communications Coupler Unit or NX Units, but output refresh communications are not possible.
Safety Network Controller		A building-block Safety Controller, which consists of a Communication Control Unit connected with Safety Control Units.
SDO communications	---	One type of EtherCAT communications in which service data objects (SDOs) are used to transmit information whenever required.
service data object	SDO	CoE asynchronous mailbox communications where all objects in the object dictionary can be read and written.
Slave Information Interface	SII	Slave information that is stored in non-volatile memory in the slave.
Slave Terminal	---	A building-block remote I/O terminal to which a Communications Coupler Unit and NX Units are mounted
subindex	---	Sub-address of an object within the object dictionary.
Sync0	---	A signal that gives the interrupt timing based on the distributed clock (DC) in EtherCAT communications. The slaves execute controls according to this interrupt timing.
Sync Manager	SM	Collection of control elements to coordinate access to concurrently used objects.
task period	---	The interval at which the primary periodic task or a periodic task is executed.
transmit PDO	TxPDO	A process data object sent from an EtherCAT slave.

Revision History

A manual revision code appears as a suffix to the catalog number on the front and back covers of the manual.

Cat. No.	W522-E1-10
-----------------	-------------------

↑
Revision code

Revision code	Date	Revised content
01	April 2013	Original production
02	June 2013	Corrected mistakes
03	September 2013	<ul style="list-style-type: none"> • Made changes accompanying release to unit version 1.1 of the Temperature Input Units. • Added information on the NX-TS□□02/TS□□04. • Corrected mistakes.
04	April 2015	<ul style="list-style-type: none"> • Made changes accompanying the addition of the NX-series CPU Unit and EtherNet/IP Coupler Unit. • Corrected mistakes.
05	April 2016	<ul style="list-style-type: none"> • Deleted information on Temperature Input Units because it was moved to the <i>NX-series Analog I/O Units User's Manual for Temperature Input Units and Heater Burnout Detection Units</i> (Cat. No. W566). • Corrected mistakes.
06	October 2016	<ul style="list-style-type: none"> • Made changes accompanying the addition of NY-series IPC Machine Controller Industrial Panel PCs and Industrial Box PCs. • Made changes accompanying the addition of the NX-series NX1P2 CPU Unit. • Corrected mistakes.
07	June 2017	<ul style="list-style-type: none"> • Made changes accompanying the upgrade of the NX-ECC203 unit version to version 1.5. • Made changes accompanying the upgrade of the NX-EIC202 unit version to version 1.2. • Corrected mistakes.
08	April 2018	<ul style="list-style-type: none"> • Made changes accompanying the addition of the NX-series NX102 CPU Unit. • Corrected mistakes.
09	July 2018	Made changes accompanying the addition of the NX-series Communication Control Unit.
10	October 2018	<ul style="list-style-type: none"> • Made revisions accompanying the appearance change of the indicators. • Corrected mistakes.

Sections in this Manual

1	Features and System Configuration	A	Appendices	1	A
2	Specifications	I	Index	2	I
3	Part Names and Functions			3	
4	Installation and Wiring			4	
5	I/O Refreshing			5	
6	Analog Input Units			6	
7	Analog Output Units			7	
8	Troubleshooting			8	
9	Inspection and Maintenance			9	

1

Features and System Configuration

This section describes NX system configuration and the applications of the Analog Input Units and Analog Output Units.

1-1	Features and Applications	1-2
1-1-1	Features of the Analog Input Units and Analog Output Units	1-2
1-1-2	Applications of the Analog Input Units and Analog Output Units	1-3
1-2	System Configuration	1-4
1-2-1	System Configuration in the Case of a CPU Unit	1-4
1-2-2	System Configuration of Slave Terminals	1-5
1-2-3	System Configuration in the Case of a Communication Control Unit	1-7
1-3	Model List	1-9
1-3-1	Model Notation	1-9
1-3-2	Analog Input Units	1-11
1-3-3	Analog Output Units	1-13
1-4	List of Functions	1-14
1-4-1	Analog Input Units	1-14
1-4-2	Analog Output Units	1-15
1-5	Support Software	1-16

1-1 Features and Applications

This section describes the features and applications of the Analog Input Units and Analog Output Units.

1-1-1 Features of the Analog Input Units and Analog Output Units

The Analog Input Units and Analog Output Units are used to process inputs and outputs of analog signals.

The NX-series Analog Input Units and Analog Output Units have the following features.



Additional Information

CPU Rack

A CPU Rack is a rack to which a CPU Unit or Communication Control Unit is mounted. For NX-series CPU Units to which NX Units can be connected, a CPU Rack is configured to have a CPU Unit with NX Units and an End Cover mounted to it. For NX-series Communication Control Units, a CPU Rack has a Communication Control Unit with NX Units and an End Cover mounted to it.

Slave Terminal

Slave Terminal is a generic name for a building block-type remote I/O terminal that contains a group of NX Units connected to a Communications Coupler Unit.

Can Be Connected to More Than One Unit with the NX Bus

NX-series Analog Input Units and Analog Output Units can be connected to the following Units, which each support an NX bus. *1

- NX-series CPU Unit
- NX-series Communications Coupler Unit
- NX-series Communication Control Unit

When these Units are used, you can unify the methods for installing, wiring, and setting up NX Units, and eventually reduce design costs.

Example:

NX-series NX1P2 CPU Unit

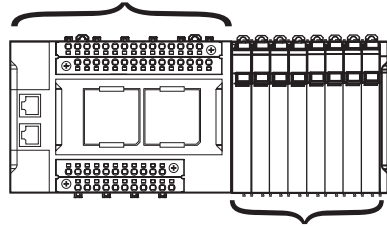

NX Units: NX-series Analog Input Units and Analog Output Units

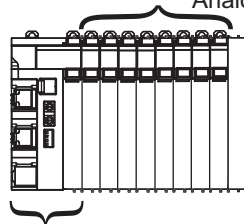

NX-series EtherCAT Coupler Unit

- *1. For whether NX Units can be connected to the CPU Unit or Communications Coupler Unit to be used, refer to the user's manual for the CPU Unit or Communications Coupler Unit to be used.

Synchronous I/O with Refresh Cycle of the NX Bus

When the NX-series CPU Unit or EtherCAT Coupler Unit is used together with NX Units that support synchronous I/O refreshing, the I/O control of multiple NX Units can be synchronized at the time to synchronize with the refresh cycle of the NX bus.

This provides an accurate I/O control because it suppresses jitter in the I/O timing of multiple NX Units.

Simple I/O Wiring with a Screwless Clamping Terminal Block

The terminal block is a screwless clamping terminal block.

You can connect the wires simply by pushing the ferrules into the terminals. The amount of wiring work is reduced without requiring the use of screws.

1-1-2 Applications of the Analog Input Units and Analog Output Units

This section describes the applications of the Analog Input Units and Analog Output Units.

Type	Application
Analog Input Units	These are Units with functionality to convert analog input signals to digital values.
Analog Output Units	These are Units with functionality to convert output set values set by a user program etc. to analog signals.

Refer to *1-3 Model List* on page 1-9 for details on the models of the Analog Input Units and Analog Output Units and to *1-4 List of Functions* on page 1-14 for details on their functions.

1-2 System Configuration

NX Unit NX-series Analog Input Units and Analog Output Units can be connected to the following Units.

- NX-series CPU Unit
- NX-series Communications Coupler Unit
- NX-series Communication Control Unit

The following explains the system configuration for each NX Unit connection destination.

1-2-1 System Configuration in the Case of a CPU Unit

The following figure shows a system configuration when a group of NX Units is connected to an NX-series NX1P2 CPU Unit.

You can connect the EtherCAT Slave Terminal to the built-in EtherCAT port on the CPU Unit. Refer to *1-2-2 System Configuration of Slave Terminals* on page 1-5 for details on the system configuration of a Slave Terminal.

Refer to the user's manual for the connected CPU Unit for details on how to configure the system if the connected CPU Unit is not an NX1P2 CPU Unit.

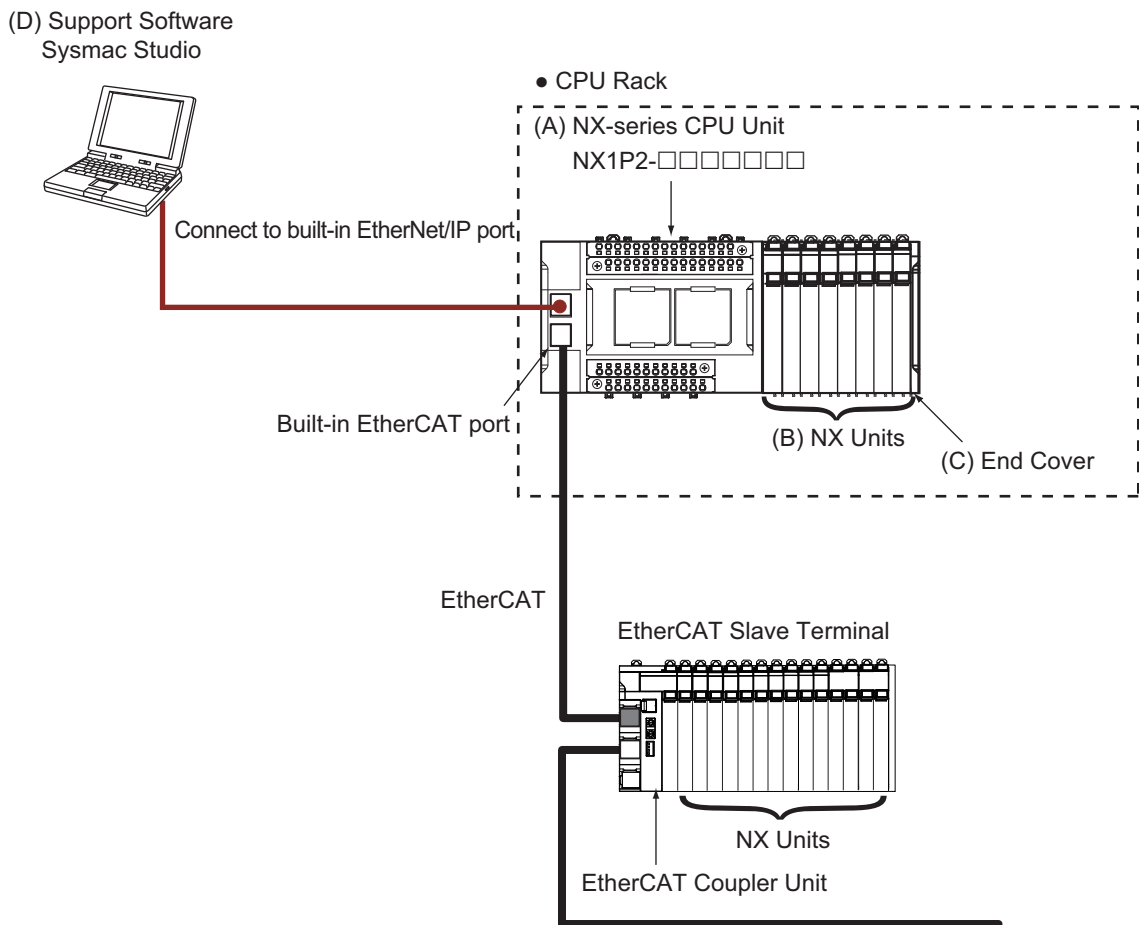

Symbol	Item	Description
(A)	NX-series CPU Unit	The Unit that serves as the center of control for a Machine Automation Controller. It executes tasks, refreshes I/O for other Units and slaves, etc. NX Units can be connected to an NX1P2 CPU Unit.

Symbol	Item	Description
(B)	NX Units ^{*1}	The NX Units perform I/O processing with connected external devices. The NX Units exchange data with the CPU Unit through I/O refreshing. A maximum of eight NX Units can be connected to an NX1P2 CPU Unit.
(C)	End Cover	The End Cover is attached to the end of a CPU Rack.
(D)	Support Software (Sysmac Studio)	A computer software application for setting, programming, debugging, and troubleshooting NJ/NX/NY-series Controllers. For an NX1P2 CPU Unit, this application performs setting operation by making a connection to a built-in EtherNet/IP port.

*1. For whether an NX Unit can be connected to the CPU Unit, refer to the version information in the user's manual for the NX Unit.

1-2-2 System Configuration of Slave Terminals

A building-block remote I/O slave provided with a group of NX Units connected to a Communications Coupler Unit is generically called a Slave Terminal.

The NX Units can be flexibly combined with a Communications Coupler Unit to achieve the optimum remote I/O slave for the application with less wiring, less work, and less space.

The following figure shows an example of the system configuration when an EtherCAT Coupler Unit is used as a Communications Coupler Unit.

Refer to the user's manual for the connected Communications Coupler Unit for details on how to configure the system when any other type of Communications Coupler Unit is used.

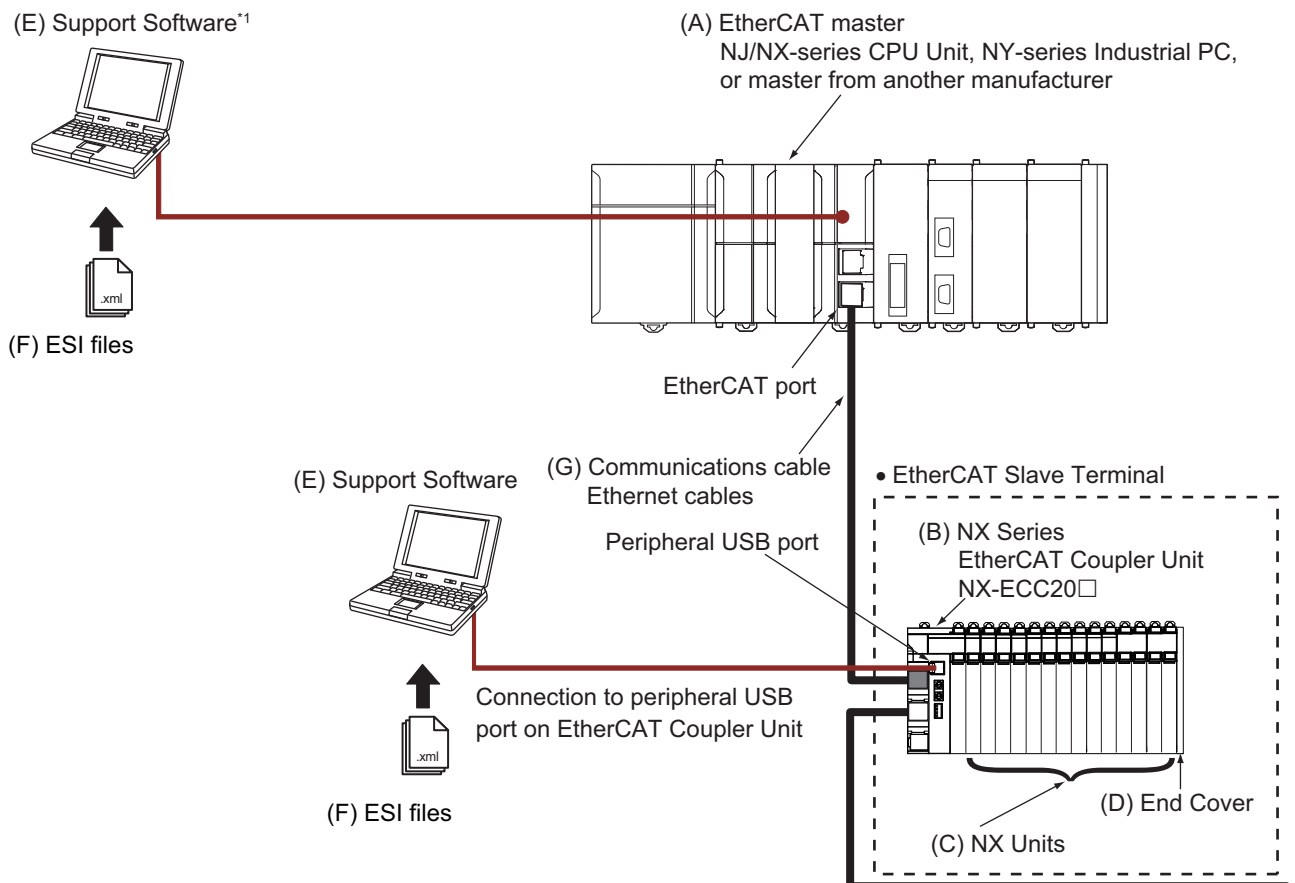

*1. The connection method for the Support Software depends on the model of the CPU Unit or Industrial PC.

Letter	Item	Description
(A)	EtherCAT master ^{*1}	The EtherCAT master manages the network, monitors the status of slaves, and exchanges I/O data with slaves.
(B)	EtherCAT Coupler Unit	<p>The EtherCAT Coupler Unit serves as an interface for process data communications on the EtherCAT network between the NX Units and the EtherCAT master.</p> <p>The I/O data for the NX Units is accumulated in the EtherCAT Coupler Unit and then all of the data is exchanged with the EtherCAT master at the same time.</p> <p>The EtherCAT Coupler Unit can also perform message communications (SDO communications) with the EtherCAT master.</p>
(C)	NX Units ^{*2}	<p>The NX Units perform I/O processing with connected external devices.</p> <p>The NX Units perform process data communications with the EtherCAT master through the EtherCAT Coupler Unit.</p>
(D)	End Cover	The End Cover is attached to the end of the Slave Terminal.
(E)	Support Software ^{*3 *4}	The Support Software runs on a personal computer and it is used to configure the EtherCAT network and EtherCAT Slave Terminal, and to program, monitor, and troubleshoot the Controllers.
(F)	ESI (EtherCAT Slave Information) file	<p>The ESI file contains information that is unique to the EtherCAT Slave Terminal in XML format. You can load an ESI file into the Support Software to easily allocate Slave Terminal process data and make other settings.</p> <p>The ESI files for OMRON EtherCAT slaves are installed in the Support Software. You can obtain the ESI files for the latest models through the Support Software's automatic update function.</p>
(G)	Communications cable	Use a double-shielded cable with aluminum tape and braiding of Ethernet category 5 (100Base-TX) or higher, and use straight wiring.

*1. An EtherCAT Slave Terminal cannot be connected to any of the OMRON CJ1W-NC□81/□82 Position Control Units even though they can operate as EtherCAT masters.

*2. For whether an NX Unit can be connected to the Communications Coupler Unit, refer to the version information in the user's manual for the NX Unit.

*3. The term Support Software indicates software that is provided by OMRON. If you connect to a master from another company, use the software tool corresponding to that master.

*4. Refer to 1-5 *Support Software* on page 1-16 for information on Support Software.

1-2-3 System Configuration in the Case of a Communication Control Unit

The following figure shows a system configuration when a group of NX Units is connected to an NX-series Communication Control Unit. To configure a Safety Network Controller, mount the Safety CPU Unit, which is one of the NX Units, to the CPU Rack of the Communication Control Unit.

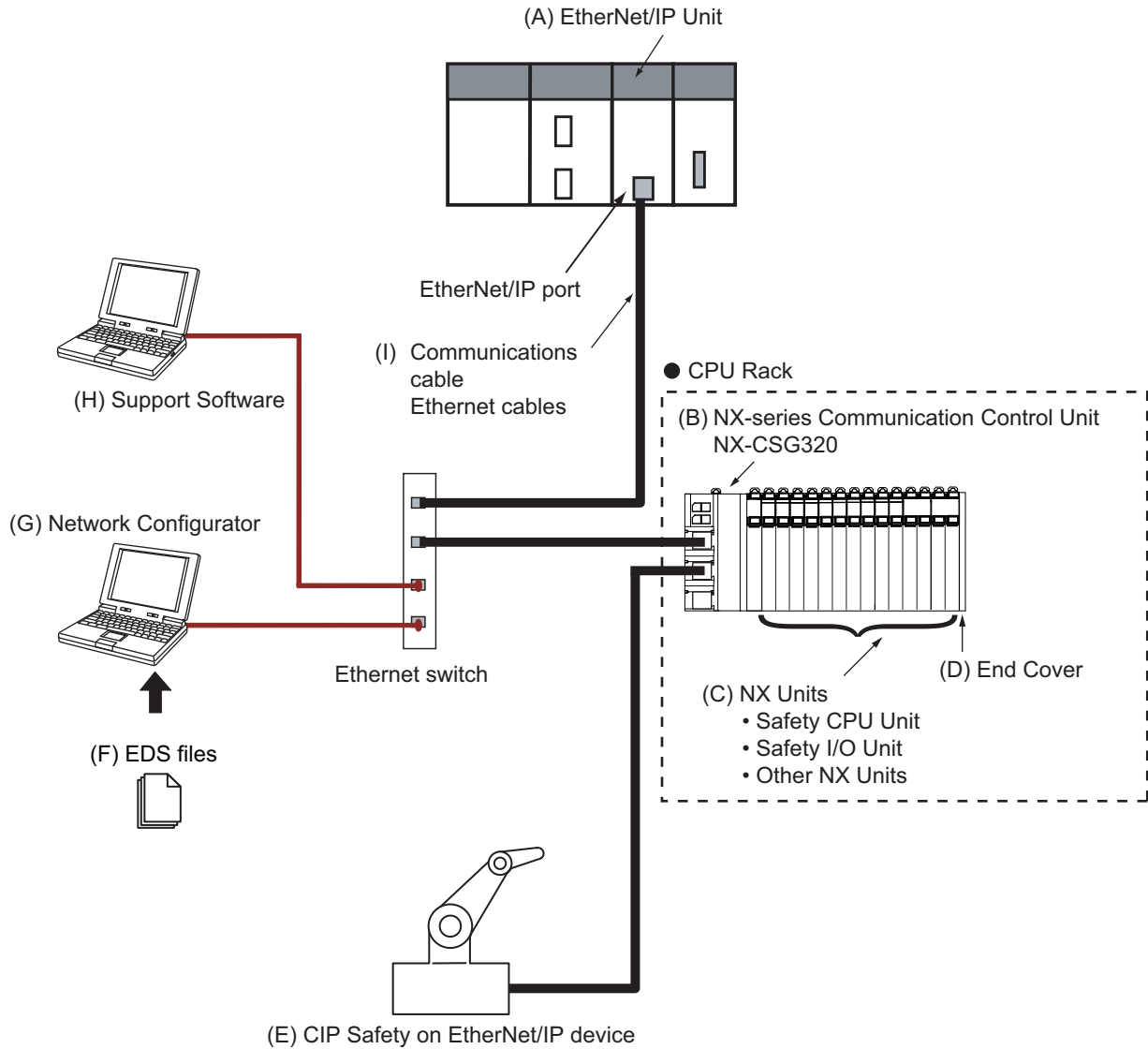

Letter	Item	Description
(A)	EtherNet/IP Unit	The EtherNet/IP Unit manages the EtherNet/IP network, monitors the status of slaves, and exchanges I/O data with the slaves. The types of EtherNet/IP Units are listed below. <ul style="list-style-type: none"> • CJ1W-EIP21 • Built-in EtherNet/IP port on a CPU Unit Refer to the user's manual for your EtherNet/IP Unit for information on the Support Software to configure the EtherNet/IP Unit.
(B)	Communication Control Unit	The Communication Control Unit has built-in EtherNet/IP ports and relays CIP Safety communications between the Safety CPU Unit and CIP Safety on EtherNet/IP devices. It also performs tag data link communications with standard controllers.

Letter	Item	Description
(C)	NX Units ^{*1}	<ul style="list-style-type: none"> • Safety CPU Unit This Unit serves as the center of control for the Safety Network Controller. It executes safety programs and CIP Safety communications. • Safety I/O Unit This Unit performs safety input or output processing. • Other NX Units Digital I/O Units and other types of NX Units perform standard I/O processing.
(D)	End Cover	The End Cover is attached to the end of the CPU Rack.
(E)	CIP Safety on EtherNet/IP device	The CIP Safety on EtherNet/IP device performs CIP Safety communications with the Safety CPU Unit.
(F)	EDS (Electronic Data Sheet) file	The EDS file contains information that is unique to the Communication Control Unit. You can load EDS files into the Network Configurator or other EtherNet/IP network setup software to easily allocate data and view or change settings.
(G)	Network Configurator	The software tool to configure the EtherNet/IP network.
(H)	Support Software ^{*2}	The Support Software runs on a personal computer and it is used to configure the CPU Rack, and to perform programming, monitoring, and troubleshooting.
(I)	Communications cable	Use an STP (shielded twisted-pair) cable of category 5 or higher. You can use either a straight or cross cable.

*1. For whether an NX Unit can be connected to the Communication Control Unit, refer to the version information in the user's manual for the NX Unit.

*2. Refer to *1-5 Support Software* on page 1-16 for information on Support Software.

1-3 Model List

1-3-1 Model Notation

The model numbers of the Analog Input Units and Analog Output Units are assigned based on the following rules.

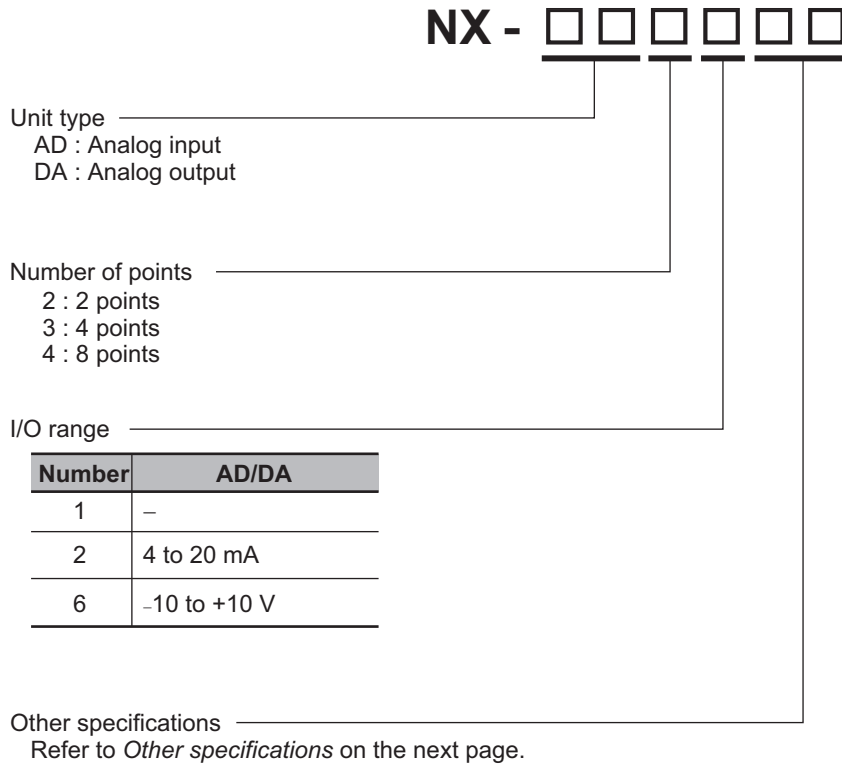

Other Specifications

● Analog Input Units

Number	Resolution	Conversion time	Input method	I/O refreshing method	
				Free-Run refreshing ^{*1} only	Switching Synchronous I/O refreshing ^{*2} and Free-Run refreshing
03	1/8000	250 μ s/point	Single-ended	Yes	---
04	1/8000	250 μ s/point	Differential	Yes	---
08	1/30000	10 μ s/point	Differential	---	Yes

*1. Free-Run refreshing

*2. Synchronous I/O refreshing

● Analog Output Units

Number	Resolution	Conversion time	I/O refreshing method	
			Free-Run refreshing ^{*1} only	Switching Synchronous I/O refreshing ^{*2} and Free-Run refreshing
03	1/8000	250 μ s/point	Yes	---
05	1/30000	10 μ s/point	---	Yes

*1. Free-Run refreshing

*2. Synchronous I/O refreshing

Refer to *Section 5 I/O Refreshing* for details on the I/O refreshing method.

1-3-2 Analog Input Units

This section shows the specifications for Analog Input Units.

Refer to *A-1-2 Analog Input Units* on page A-4 for details on the specifications of individual Analog Input Units.

Analog Input Units (Screwless Clamping Terminal Block, 12 mm Width)

Model	Number of points	Input range	Resolution	Input method	I/O refreshing method	Conversion time	Reference
NX-AD2203	2 points	4 to 20 mA	1/8000	Single-ended	Free-Run refreshing	250 μ s/point	P. A-5
NX-AD2204							P. A-7
NX-AD2208			Differential	Switching Synchronous I/O refreshing and Free-Run refreshing	10 μ s/point	P. A-8	
NX-AD2603		-10 to +10 V	1/8000	Single-ended	Free-Run refreshing	250 μ s/point	P. A-9
NX-AD2604							P. A-10
NX-AD2608			Differential	Switching Synchronous I/O refreshing and Free-Run refreshing	10 μ s/point	P. A-11	
NX-AD3203	4 points	4 to 20 mA	1/8000	Single-ended	Free-Run refreshing	250 μ s/point	P. A-12
NX-AD3204							P. A-13
NX-AD3208			Differential	Switching Synchronous I/O refreshing and Free-Run refreshing	10 μ s/point	P. A-14	
NX-AD3603		-10 to +10 V	1/8000	Single-ended	Free-Run refreshing	250 μ s/point	P. A-15
NX-AD3604							P. A-16
NX-AD3608			Differential	Switching Synchronous I/O refreshing and Free-Run refreshing	10 μ s/point	P. A-17	

Model	Number of points	Input range	Resolution	Input method	I/O refreshing method	Conversion time	Reference
NX-AD4203	8 points	4 to 20 mA	1/8000	Single-ended	Free-Run refreshing	250 μ s/point	P. A-18
NX-AD4204							P. A-19
NX-AD4208			1/30000	Differential	Switching Synchronous I/O refreshing and Free-Run refreshing	10 μ s/point	P. A-20
NX-AD4603		-10 to +10 V	1/8000	Single-ended	Free-Run refreshing	250 μ s/point	P. A-21
NX-AD4604							P. A-22
NX-AD4608			1/30000	Differential	Switching Synchronous I/O refreshing and Free-Run refreshing	10 μ s/point	P. A-23

1-3-3 Analog Output Units

This section shows the specifications for Analog Output Units.

Refer to *A-1-3 Analog Output Units* on page A-24 for details on the specifications of individual Analog Output Units.

Analog Output Units (Screwless Clamping Terminal Block, 12 mm Width)

Model	Number of points	Output range	Resolution	I/O refreshing method	Conversion time	Reference
NX-DA2203	2 points	4 to 20 mA	1/8000	Free-Run refreshing	250 μ s/point	P. A-25
NX-DA2205			1/30000	Switching Synchronous I/O refreshing and Free-Run refreshing	10 μ s/point	P. A-27
NX-DA2603		-10 to +10 V	1/8000	Free-Run refreshing	250 μ s/point	P. A-29
NX-DA2605			1/30000	Switching Synchronous I/O refreshing and Free-Run refreshing	10 μ s/point	P. A-30
NX-DA3203	4 points	4 to 20 mA	1/8000	Free-Run refreshing	250 μ s/point	P. A-31
NX-DA3205			1/30000	Switching Synchronous I/O refreshing and Free-Run refreshing	10 μ s/point	P. A-33
NX-DA3603		-10 to +10 V	1/8000	Free-Run refreshing	250 μ s/point	P. A-35
NX-DA3605			1/30000	Switching Synchronous I/O refreshing and Free-Run refreshing	10 μ s/point	P. A-36

1-4 List of Functions

This section provides an overview of functions that Analog Input Units and Analog Output Units have. Refer to the specifications of each model in *A-1 Data Sheet* on page A-2 for details on the functions.

1-4-1 Analog Input Units

Function name	Description	Reference
Free-Run Refreshing	With this I/O refreshing method, the refresh cycle of the NX bus and the I/O refresh cycles of the NX Units are asynchronous.	<i>5-2-4 Free-Run Refreshing</i> on page 5-9
Synchronous I/O Refreshing	With this I/O refreshing method, the timing to read inputs or to refresh outputs is synchronized on a fixed interval between more than one NX Unit connected to a CPU Unit. In addition, with this I/O refreshing method, the timing to read inputs or to refresh outputs is synchronized on a fixed interval between more than one NX Unit on more than one Slave Terminal.	<i>5-2-5 Synchronous Input Refreshing</i> on page 5-13
Selecting Channel To Use	This function omits the conversion processing for unused inputs. It is used to reduce the conversion cycle for its own Unit.	<i>6-5-2 Selecting Channel To Use</i> on page 6-13
Moving Average	This function uses the average value of inputs of the set time as the converted value. When the input value fluctuates frequently due to noises, averaging can be used to obtain a stable converted value. This function can be used only for Free-Run refreshing.	<i>6-5-3 Moving Average</i> on page 6-17
Input Disconnection Detection	This function detects disconnections of the analog input signal lines. It can be used only for models with an input range of 4 to 20 mA.	<i>6-5-4 Input Disconnection Detection</i> on page 6-23
Over Range/Under Range Detection	This function detects when the input signal exceeds the range for which conversion is possible.	<i>6-5-5 Over Range/Under Range Detection</i> on page 6-24
User Calibration	This function corrects offsets in the converted values that occur due to the deterioration of the NX Units and calibrate the Units.	<i>6-5-6 User Calibration</i> on page 6-25

1-4-2 Analog Output Units

Function name	Description	Reference
Free-Run Refreshing	With this I/O refreshing method, the refresh cycle of the NX bus and the I/O refresh cycles of the NX Units are asynchronous.	5-2-4 <i>Free-Run Refreshing</i> on page 5-9
Synchronous I/O Refreshing	With this I/O refreshing method, the timing to read inputs or to refresh outputs is synchronized on a fixed interval between more than one NX Unit connected to a CPU Unit. In addition, with this I/O refreshing method, the timing to read inputs or to refresh outputs is synchronized on a fixed interval between more than one NX Unit on more than one Slave Terminal.	5-2-6 <i>Synchronous Output Refreshing</i> on page 5-17
Selecting Channel To Use	This function omits the conversion processing for unused inputs. It is used to reduce the conversion cycle for its own Unit.	7-5-2 <i>Selecting Channel To Use</i> on page 7-10
Load Rejection Output Setting	A function that performs the preset output operation when the Analog Output Unit cannot receive output data due to the following causes: When the Unit is connected to a CPU Unit: NX bus error, CPU Unit watchdog timer error, etc. When the Unit is connected to a Communications Coupler Unit: Host error on the Communications Coupler Unit, NX bus error, etc. When the Unit is connected to a Communication Control Unit: NX bus error, Communication Control Unit watchdog timer error, etc.	7-5-3 <i>Load Rejection Output Setting</i> on page 7-14
Over Range/Under Range Detection	This function detects when the output set value exceeds the range for which conversion is possible.	7-5-4 <i>Over Range/Under Range Detection</i> on page 7-19
User Calibration	This function corrects offsets in the converted values that occur due to the deterioration of the NX Units and calibrate the Units.	7-5-5 <i>User Calibration</i> on page 7-20

1-5 Support Software

The Support Software that is used depends on the system configuration.

- **Support Software for a System Configured with a CPU Unit**

If your system is configured by connecting an NX Unit to a CPU Unit, the Sysmac Studio is used as the Support Software.

- **Support Software for a System Configured with a Slave Terminal**

If your system is configured by connecting an NX Unit to a Communications Coupler Unit, refer to the user's manual for the Communications Coupler Unit for information on the Support Software.

- **Support Software for a System Configured with a Communication Control Unit**

If your system is configured by connecting an NX Unit to a Communication Control Unit, the Sysmac Studio is used as the Support Software.

Depending on the Unit to which the NX Unit is connected, refer to the following appendices for information on the Support Software versions.

A-5 Version Information with CPU Units on page A-55

A-6 Version Information with Communications Coupler Units on page A-57

A-7 Version Information with Communication Control Units on page A-61

2

Specifications

This section describes the general specifications and individual specifications of the Analog Input Units and Analog Output Units.

2-1	General Specifications	2-2
2-2	Individual Specifications	2-3

2-1 General Specifications

This section provides the general specifications of the Analog Input Units and Analog Output Units.

Item		Specification
Enclosure		Mounted in a panel
Grounding methods		Ground of 100 Ω or less
Operating environment	Ambient operating temperature	0 to 55°C
	Ambient operating humidity	10 to 95% RH (with no icing or condensation)
	Atmosphere	Must be free from corrosive gases.
	Ambient storage temperature	-25 to 70°C (with no icing or condensation)
	Altitude	2,000 m max.
	Pollution degree	Pollution degree 2 or less: Conforms to JIS B 3502 and IEC 61131-2.
	Noise immunity	Conforms to IEC 61000-4-4, 2 kV (power supply line)
	Overvoltage category	Category II: Conforms to JIS B 3502 and IEC 61131-2.
	EMC immunity level	Zone B
	Vibration resistance	Conforms to IEC 60068-2-6. 5 to 8.4 Hz with amplitude of 3.5 mm, 8.4 to 150 Hz, acceleration of 9.8 m/s ² 100 min each in X, Y, and Z directions (10 sweeps of 10 min each = 100 min total)
	Shock resistance	Conforms to IEC 60068-2-27, 147 m/s ² , 3 times each in X, Y, and Z directions
	Insulation resistance	*1
Dielectric strength	*1	
Applicable standards*2		cULus: Listed (UL 508), ANSI/ISA 12.12.01, EU: EN 61131-2, C-Tick, KC (KC Registration), NK, and LR

*1. Varies with NX Unit Models. Refer to *A-1 Data Sheet* on page A-2 for the specifications of individual NX Units.

*2. Refer to the OMRON website (www.ia.omron.com) or ask your OMRON representative for the most recent applicable standards for each model.

2-2 Individual Specifications

Refer to *A-1 Data Sheet* on page A-2 for the specifications of individual Analog Input Units and Analog Output Units.

3

Part Names and Functions

This section describes the names and functions of the parts of the Analog Input Units and Analog Output Units.

3-1 Part Names	3-2
3-1-1 Screwless Clamping Terminal Block Type	3-2
3-2 Indicators	3-6
3-2-1 TS Indicator	3-7
3-2-2 Appearance Change of the Indicators	3-8

3-1 Part Names

This section describes the names and functions of the parts of the Analog Input Units and Analog Output Units.

3-1-1 Screwless Clamping Terminal Block Type

● 12 mm Width

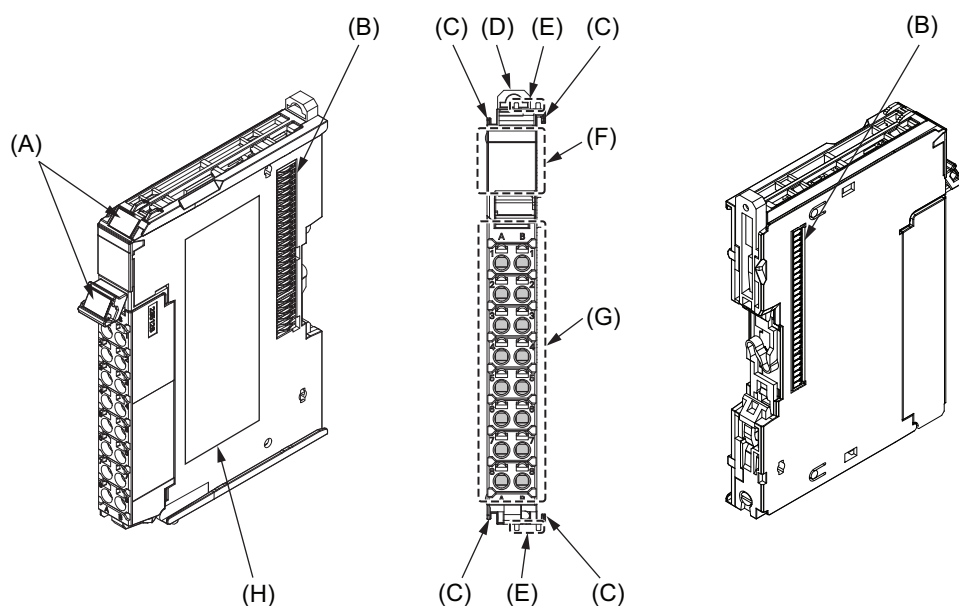

Letter	Name	Function
(A)	Marker attachment locations	The locations where markers are attached. The markers made by OMRON are installed for the factory setting. Commercially available markers can also be installed. Refer to 4-1-2 <i>Attaching Markers</i> on page 4-4
(B)	NX bus connector	This connector is used to connect each Unit.
(C)	Unit hookup guides	These guides are used to connect two Units.
(D)	DIN Track mounting hooks	These hooks are used to mount the NX Unit to a DIN Track.
(E)	Protrusions for removing the Unit	The protrusions to hold when removing the Unit.
(F)	Indicators	The indicators show the current operating status of the Unit. Refer to 3-2 <i>Indicators</i> on page 3-6
(G)	Terminal block	The terminal block is used to connect external devices. The number of terminals depends on the type of Unit.
(H)	Unit specifications	The specifications of the Unit are given.

Terminal Blocks

There are two models of screwless clamping terminal blocks: NX-TB□□□2 and NX-TB□□□1. Each model has three types of terminal blocks: 8-terminal type, 12-terminal type, and 16-terminal type.

● NX-TB□□□2

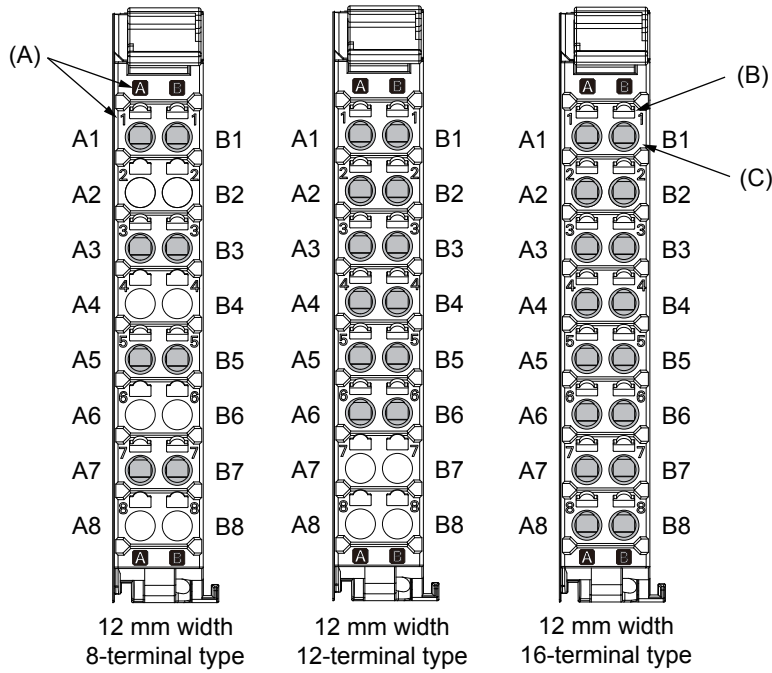

● NX-TB□□□1

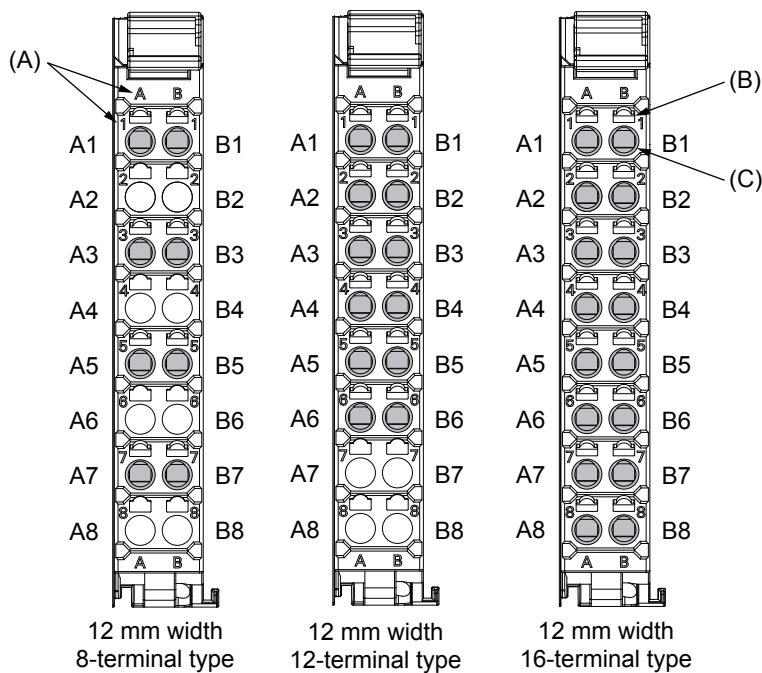

Letter	Name	Function
(A)	Terminal number indications	Terminal numbers for which A to D indicate the column, and 1 to 8 indicate the line are displayed. The terminal number is a combination of column and line, i.e. A1 to A8 and B1 to B8. The terminal number indications are the same regardless of the number of terminals on the terminal block.
(B)	Release holes	Insert a flat-blade screwdriver into these holes to connect and remove the wires.
(C)	Terminal holes	The wires are inserted into these holes.

The NX-TB□□□2 and NX-TB□□□1 Terminal Blocks have different terminal current capacities. The NX-TB□□□2 has 10 A and NX-TB□□□1 has 4 A.

To differentiate between the two models of terminal blocks, use the terminal number column indications. The terminal block with white letters on a dark background is the NX-TB□□□2.

You can mount either NX-TB□□□1 or NX-TB□□□2 Terminal Blocks to the Units that the current capacity specification of the terminals is 4 A or less.

You can only mount the NX-TB□□□2 Terminal Block to the Units that the current capacity specification of the terminals is greater than 4 A.



Additional Information

- Each of the Analog Input Units and Analog Output Units is compatible with only one of three types of terminal blocks. You cannot use a terminal block with a number of terminals that differs from the specifications for a particular Unit.
- The 8-terminal type and 12-terminal type do not have terminal holes and release holes for following terminal numbers.

8-terminal type: A2, A4, A6, A8, B2, B4, B6, and B8

12-terminal type: A7, A8, B7, and B8

● Applicable Terminal Blocks for Each Unit Model

The following indicates the terminal blocks that are applicable to each Unit.

Unit model number	Terminal block			
	Model	Number of terminals	Ground terminal mark	Current capacity
NX-AD2□□□	NX-TBA081	8	Not provided	4 A
	NX-TBA082			10 A
NX-AD3□□□	NX-TBA121	12		4 A
	NX-TBA122			10 A
NX-AD4□□□	NX-TBA161	16		4 A
	NX-TBA162			10 A
NX-DA2□□□	NX-TBA081	8		4 A
	NX-TBA082			10 A
NX-DA3□□□	NX-TBA121	12		4 A
	NX-TBA122			10 A



Precautions for Correct Use

You can mount either NX-TB□□□1 or NX-TB□□□2 Terminal Blocks to the Units that the current capacity specification of the terminals is 4 A or less.

However, even if you mount the NX-TB□□□2 Terminal Block, the current specification does not change because the current capacity specification of the terminals on the Units is 4 A or less.

Refer to *A-4 List of Screwless Clamping Terminal Block Models* on page A-54 for information on the models of terminal blocks.

3-2 Indicators

There is an indicator that shows the current operating status of the Analog Input Unit or Analog Output Unit. The indicator is shown below.

The appearance of the indicators has been changed for models released in or before September 2018 with lot numbers that represent the date of or after September 20, 2018. In this manual, those models are shown with the indicators after the change. For details on the applicable models and the changes, refer to 3-2-2 *Appearance Change of the Indicators* on page 3-8.

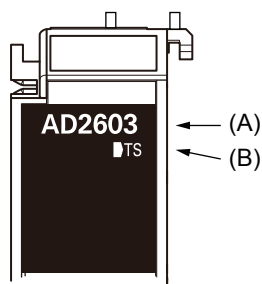

12 mm width

Letter	Name	Function
(A)	Model number indications	<p>The model numbers of the NX Unit are displayed. (Example) "AD2603" in the case of NX-AD2603</p> <p>The NX Units are separated in the following color depending on the type of inputs and outputs.</p> <ul style="list-style-type: none"> • Analog Input Unit: Orange • Analog Output Unit: Yellow
(B)	TS indicator	The indicator shows the current operating status of the NX Unit.



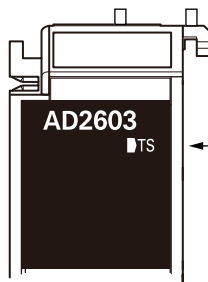

The following section describes the specifications of the TS indicator.

3-2-1 TS Indicator



This indicator shows the current status of the Analog I/O Unit and its communications status with the CPU Unit, with the Communications Coupler Unit, or with the Communication Control Unit.

The meanings of light statuses are described as follows:

Color	Status	Description
Green	 Lit	<ul style="list-style-type: none"> The Unit is operating normally. The Unit is ready for I/O refreshing. I/O checking is operating.*¹
	 Flashing at 2-s intervals.	<ul style="list-style-type: none"> Initializing Restarting is in progress for the Unit. Downloading
Red	 Lit	A hardware failure, WDT error, or other fatal error that is common to all I/O Units occurred.
	 Flashing at 1-s intervals.	A communications error or other NX bus-related error that is common to all I/O Units occurred.
---	 Not lit	<ul style="list-style-type: none"> No Unit power supply Restarting is in progress for the Unit. Waiting for initialization to start

*1. Refer to the manual for the Communications Coupler Unit for the status of the indicator on the Communications Coupler Units when I/O checking is in progress.

3-2-2 Appearance Change of the Indicators

The appearance of the indicators has been changed for models released in or before September 2018 with lot numbers that represent the date of or after September 20, 2018. See below for details on the applicable models and the changes. Models that are not listed here have the appearance after the change.

Applicable Models

NX-AD2203, NX-AD2204, NX-AD2208, NX-AD2603, NX-AD2604, NX-AD2608, NX-AD3203, NX-AD3204, NX-AD3208, NX-AD3603, NX-AD3604, NX-AD3608, NX-AD4203, NX-AD4204, NX-AD4208, NX-AD4603, NX-AD4604, NX-AD4608, NX-DA2203, NX-DA2205, NX-DA2603, NX-DA2605, NX-DA3203, NX-DA3205, NX-DA3603, NX-DA3605

Change Details

The shape of the light emitting part of the TS indicator has been changed from a square to a pentagon. See below.



Before change



After change

4

Installation and Wiring

This section describes how to install the NX Units, the types of power supplies provided to the NX Units and wiring methods, and how to wire the NX Units.

4

4-1	Installing NX Units	4-2
4-1-1	Installing NX Units	4-2
4-1-2	Attaching Markers	4-4
4-1-3	Removing NX Units	4-6
4-1-4	Installation Orientation	4-7
4-2	Power Supply Types and Wiring	4-9
4-2-1	Applications of I/O Power Supply and Supply Methods	4-9
4-2-2	Calculating the Total Current Consumption from I/O Power Supply	4-11
4-3	Wiring the Terminals	4-12
4-3-1	Wiring to the Screwless Clamping Terminal Block	4-12
4-3-2	Checking the Wiring	4-28
4-4	Wiring Examples	4-29
4-4-1	Wiring the Analog Input Units	4-29
4-4-2	Wiring the Analog Output Units	4-31
4-4-3	Precautions when Using Common Power Supply for Input Devices of Analog Input Units	4-32

4-1 Installing NX Units

This section describes how to install NX Units.

Refer to the user's manual for the CPU Unit, Communications Coupler Unit, or Communication Control Unit to which NX Units are connected for information on preparations of installation and installation in a control panel.

4-1-1 Installing NX Units

This section describes how to mount two NX Units to each other.

Always turn OFF the power supply before you mount NX Units.

Always mount NX Units one at a time. If you attempt to mount multiple NX Units that are already connected together, the connections between the NX Units may separate from each other and fall.



Precautions for Safe Use

- Always turn OFF the power supply before installing the Unit. If the power supply is not OFF, the Unit may malfunction or may be damaged.
- Do not apply labels or tape on the NX Units. When the Unit is installed or removed, adhesive or scrap may adhere to the pins of the NX bus connector, which may cause malfunctions.
- Do not touch the pins in the NX bus connector on the Unit. Dirt may adhere to the pins in the NX bus connector, which may result in malfunctions.

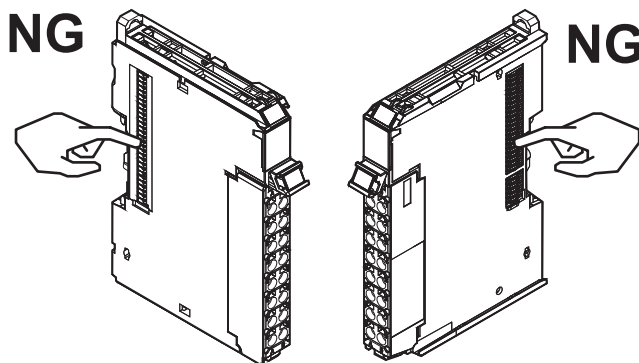

Example: NX Unit (12 mm width)

- Do not write on an NX Unit with ink within the restricted region that is shown in the following figure. Also do not get this area dirty. When the Unit is installed or removed, ink or dirt may adhere to the pins in the NX bus connector, which may result in malfunctions in the Slave Terminal.

Refer to the user's manual for the connected CPU Unit, Communications Coupler Unit, or Communication Control Unit for details on the restricted region on the CPU Unit, Communications Coupler Unit, or Communication Control Unit.

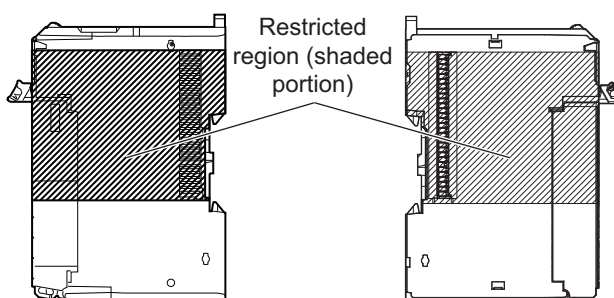



Precautions for Correct Use

- When you install an NX Unit, do not touch or bump the pins in the NX bus connector.
- When you handle an NX Unit, be careful not to apply any stress to the pins in the NX bus connector. If you install an NX Unit and turns ON the power supply when the pins in the NX bus connector are deformed, a contact defect may cause malfunctions.

- 1 From the front of the previously mounted NX Unit, engage the Unit hookup guides on a new Unit with the Unit hookup guides on the previously mounted NX Unit.

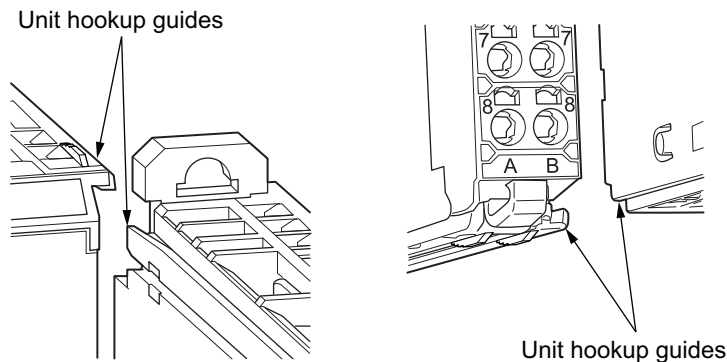

- 2 Slide the NX Unit in on the hookup guides.

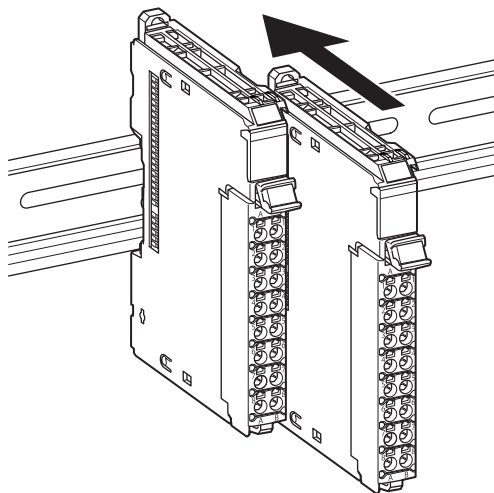

- 3 Press the NX Unit with a certain amount of force against the DIN Track until you hear the DIN Track mounting hook lock into place.

When you mount the NX Unit, it is not necessary to release the DIN track mounting hook on the NX Unit.

After you mount the NX Unit, make sure that it is locked to the DIN Track.



Additional Information

- Normally, it is not necessary to release the DIN track mounting hook when you mount the NX Unit. However, if you mount the NX Unit on a DIN Track that is not a recommended DIN Track, the DIN track mounting hook may not lock correctly. If that happens, first unlock the DIN track mounting hook, mount the NX Unit to the DIN Track, then lock the DIN track mounting hook.
- Refer to the user's manual for the CPU Unit to which NX Units can be connected for information on how to mount the CPU Unit, and how to mount NX Units to the CPU Unit.
- Refer to the user's manual for the Communications Coupler Unit for information on how to mount the Communications Coupler Unit, and how to mount the NX Unit to the Communications Coupler Unit.
- Refer to the user's manual for the Communication Control Unit for information on how to mount the Communication Control Unit, and how to mount NX Units to the Communication Control Unit.

4-1-2 Attaching Markers

Markers can be attached to the NX Units and terminal blocks on NX Units to identify them.

The plastic markers made by OMRON are installed for the factory setting. The ID information can be written on them.

Commercially available markers can also be installed.

Replace the markers made by OMRON if you use commercially available markers now.

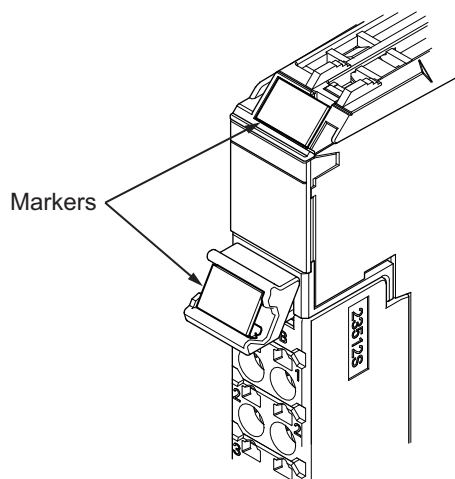

● Installation Method

Insert the protrusions on the markers into the marker attachment locations on the NX Units and terminal blocks on NX Units.

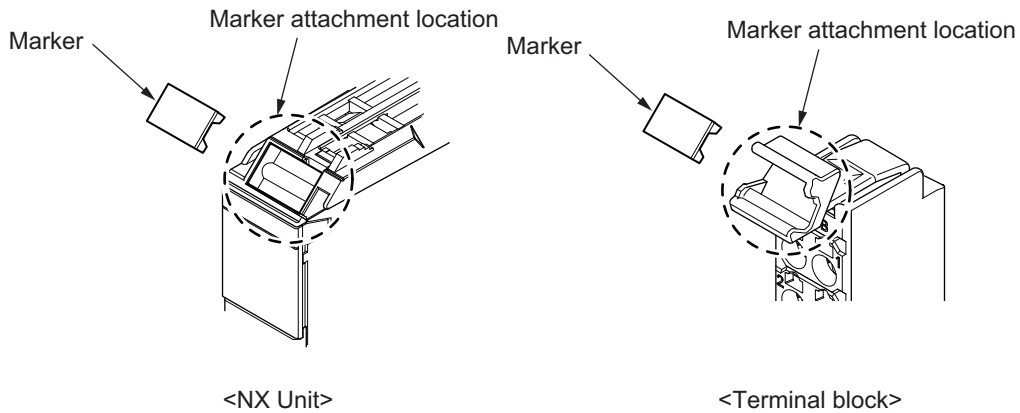

● Commercially Available Markers

Commercially available markers are made of plastic and can be printed on with a special printer. To use commercially available markers, purchase the following products.

Product name	Model number	
	Manufactured by Phoenix Contact	Manufactured by Weidmuller
Markers	UC1-TMF8	DEK 5/8
Special marker printer	UM EN BLUEMARK X1	PrintJet PRO

The markers made by OMRON cannot be printed on with commercially available special printers.

4-1-3 Removing NX Units



Precautions for Safe Use

Always turn OFF the Unit power supply and I/O power supply before you remove the NX Unit.

- 1 Use a flat-blade screwdriver to pull up the DIN Track mounting hook on the Unit to remove.

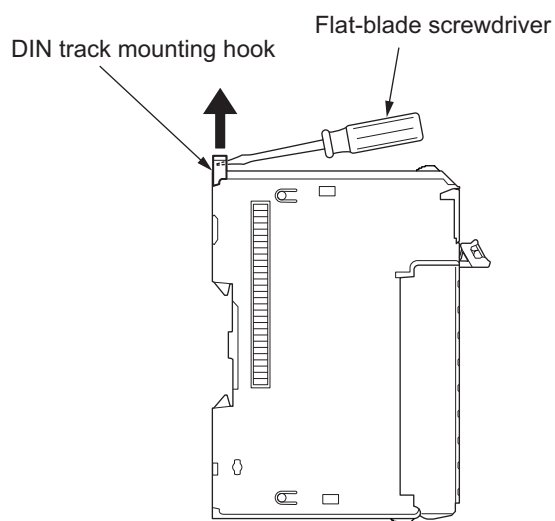

- 2 Put your fingers on the protrusions for removing multiple NX Units including the Unit to be removed, then pull out straight forward to remove.

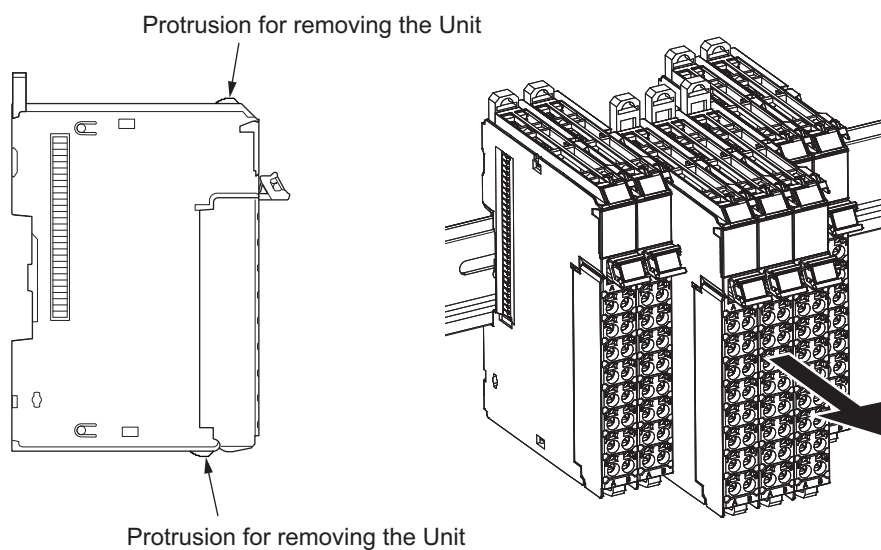



Precautions for Correct Use

- When removing an NX Unit, remove multiple Units together which include the one you want to remove. If you attempt to remove only one Unit, it is stuck and hard to pull out.
- Do not unlock the DIN track mounting hooks on all of the NX Units at the same time. If you unlock the DIN Track mounting hooks on all of the NX Units at the same time, all of the Units may come off.

4-1-4 Installation Orientation

The following explains the installation orientation for each NX Unit connection destination.

Installation Orientation in the Case of a CPU Unit or Communication Control Unit

Orientation is possible only in the upright installation orientation.

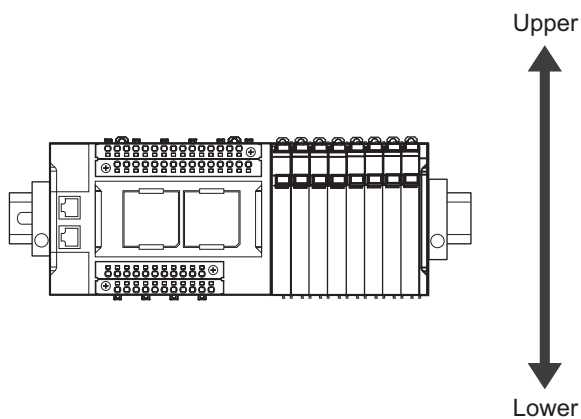

However, there are restrictions on the specifications depending on the NX Units to be used.

Refer to the user's manuals for the NX Units and System Units that you will use for details on restrictions.

Installation Orientation in the Case of a Slave Terminal

Orientation is possible in the following six directions.

(A) is the upright orientation and (B) to (F) are other orientations.

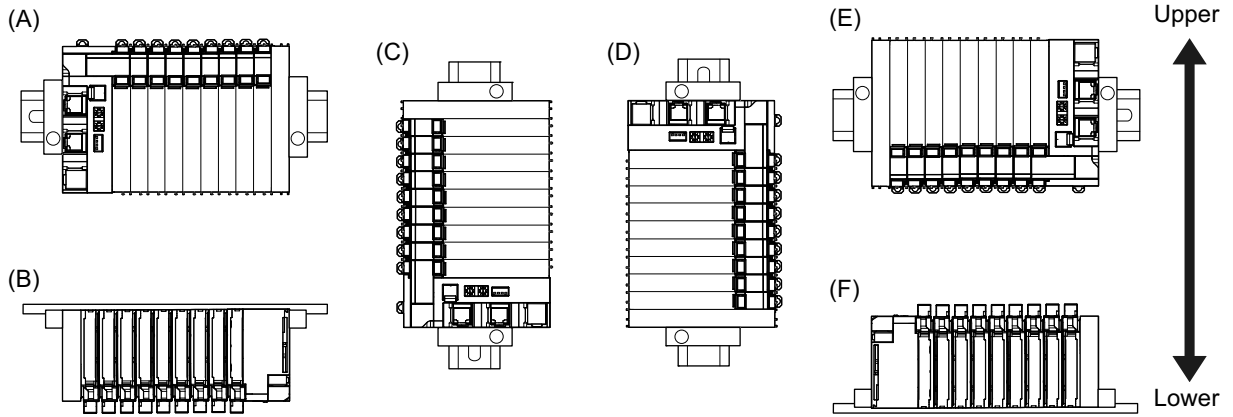

However, there are restrictions on the installation orientation and restrictions to the specifications that can result from the Communications Coupler Units and NX Units that are used.

Refer to the user's manuals for the Communications Coupler Units, NX Units and System Units that you will use for details on restrictions.



Precautions for Safe Use

For installation orientations (C) and (D) in the above figure, support the cables, e.g., with a duct, so that the End Plate on the bottom is not subjected to the weight of the cables. The weight of the cables may cause the bottom End Plate to slide downward so that the Slave Terminal is no longer secured to the DIN Track, which may cause malfunctions.

4-2 Power Supply Types and Wiring

There are the following two types of power supplies that supply power to the NX Units.

Power supply name	Description
NX Unit power supply	This power supply is used for operating the NX Units.
I/O power supply	This power supply is used for driving the I/O circuits of the NX Units and for the connected external devices.

The method for supplying power to the NX Units and the wiring method depend on the specifications for the CPU Unit, Slave Terminal, or Communication Control Unit to which NX Units are connected. Depending on where the NX Unit is connected, refer to *Designing the Power Supply System* or *Wiring* in the following manuals for details on the method for supplying power to the NX Units and the wiring method.

- CPU Unit Hardware User's Manual
- User's manual for the Communications Coupler Unit
- User's manual for the Communication Control Unit

The subsequent sections describe the applications of I/O power supply for the Analog Input Units and Analog Output Units and supply methods, and how to calculate the total current consumption from the I/O power supply.

4-2-1 Applications of I/O Power Supply and Supply Methods

The applications of I/O power supply and supply methods for the Analog Input Units and Analog Output Units are given as follows:

Applications of I/O Power Supply

The I/O power supply is used for the following applications.

- Driving the I/O circuits of the Analog Input Units and Analog Output Units
- Power supply for the connected external devices

I/O Power Supply Method

This power is supplied by one of the following two methods. Refer to *A-1 Data Sheet* on page A-2 for the supply methods for the individual Analog Input Units and Analog Output Units.

● Supply from the NX Bus

This power is supplied through the NX bus connectors by connecting an I/O power supply to the I/O power supply terminals on the Communications Coupler Unit or Additional I/O Power Supply Unit.

For the Units to which I/O power supply is provided by a CPU Rack with an NX-series CPU Unit, refer to *Designing the Power Supply System* or *Wiring* in the hardware user's manual for the CPU Unit to be connected.

For the Units to which I/O power supply is provided by a Slave Terminal, refer to *Designing the Power Supply System* or *Wiring* in the user's manual for the Communications Coupler Unit to be connected.

For the Units to which I/O power supply is provided by a CPU Rack with a Communication Control Unit, refer to *Designing the Power Supply System* or *Wiring* in the user's manual for the Communication Control Unit to be connected.

● Supply from External Source

This power is supplied to the Units from an external source.

I/O power is supplied by connecting an I/O power supply to the I/O power supply terminals on the Units.



Additional Information

Power Supply-related Units for the NX-series

The following three NX-series Units are related to power supply.

- Additional NX Unit Power Supply Unit
- Additional I/O Power Supply Unit
- I/O Power Supply Connection Unit

Refer to the *NX-series System Unit User's Manual (Cat. No. W523)* for the specifications of these Units.

For a complete list of the latest power supply Units in the NX Series, refer to the product catalog or OMRON websites, or contact your OMRON representatives.

4-2-2 Calculating the Total Current Consumption from I/O Power Supply

The total current consumption of I/O power supplied from the NX bus must be within the range of the maximum I/O power supply current of the Communications Coupler Unit, Communication Control Unit, or Additional I/O Power Supply Unit.

However, when an Additional I/O Power Supply Unit is connected to the CPU Rack of a CPU Unit, the maximum I/O power supply current value may be smaller than that of the Additional I/O Power Supply Unit. For example, the maximum I/O power supply current for the CPU Rack of an NX1P2 CPU Unit is 4 A.

To confirm this and to calculate the I/O power supply capacity, calculate the total current consumption from I/O power supply from the NX bus.

The total current consumption from I/O power supply from the NX bus is the total sum of current consumption from I/O power supply of the NX Unit that supplies the I/O power from the NX bus, the current of each applicable I/O circuit, and current consumption of any connected external devices.

Note that the current consumption from I/O power supply indicated in the data sheet for each Unit type does not include the load current of any external connection load and current consumption of any connected external devices.

The total current consumption from I/O power supply of the Analog Input Units and Analog Output Units is calculated as follows:

- **Total Current Consumption from I/O Power Supply of the Analog Input Units**
= (Current consumption from I/O power supply of the Analog Input Units) + (Total current consumption of connected external devices)
- **Total Current Consumption from I/O Power Supply of the Analog Output Units**
= (Current consumption from I/O power supply of the Analog Output Units) + (Total current consumption of connected external devices)

Refer to *A-1 Data Sheet* on page A-2 for the current consumption from the I/O power supply for the individual Analog Input Units and Analog Output Units.



Precautions for Safe Use

The I/O power supply current for the CPU Rack with an NX-series CPU Unit should be within the range specified for the CPU Unit model. For example, use the NX1P2 CPU Unit with a current of 4 A or less. Using the currents that are outside of the specifications may cause failure or damage. Refer to the user's manual for the connected CPU Unit for the I/O power supply current for the CPU Unit model.

4-3 Wiring the Terminals

This section describes how to wire the terminals on the Analog Input Units and Analog Output Units.



WARNING



Make sure that the voltages and currents that are input to the Units and slaves are within the specified ranges.

Inputting voltages or currents that are outside of the specified ranges may cause accidents or fire.

4-3-1 Wiring to the Screwless Clamping Terminal Block

This section describes how to connect wires to the screwless clamping terminal block, the installation and removing methods, and functions for preventing incorrect attachment.

You can connect ferrules that are attached to the twisted wires to the screwless clamping terminal block. You can also connect the twisted wires or the solid wires to the screwless clamping terminal block. If you connect the ferrules, all you need to do to connect the wires is to insert the ferrules into the terminal holes.

Wiring Terminals

The terminals to be wired are as follows.

- I/O power supply terminals
- I/O terminals

Applicable Wires

The wires that you can connect to the screwless clamping terminal block are twisted wires, solid wires, and ferrules that are attached to the twisted wires. The following section describes the dimensions and processed methods for applicable wires.

● Dimensions of Wires Connected to the Terminal Block

The dimensions of wires that you can connect into the terminal holes of the screwless clamping terminal block are as in the figure below.

Process the applicable wires that are specified in the following description to apply the dimensions.

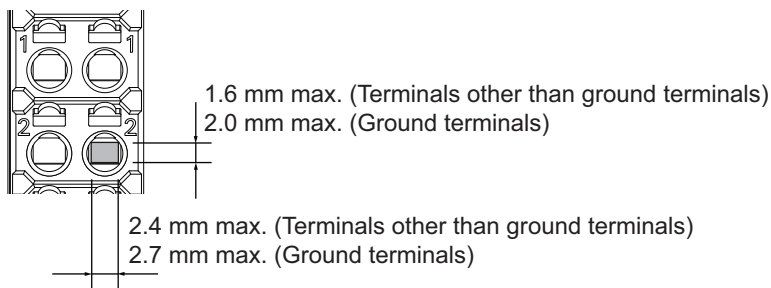

● **Using Ferrules**

If you use ferrules, attach the twisted wires to them.

Observe the application instructions for your ferrules for the wire stripping length when attaching ferrules.

Always use plated one-pin ferrules. Do not use unplated ferrules or two-pin ferrules.

The applicable ferrules, wires, and crimping tools are listed in the following table.

Terminal types	Manufacturer	Ferrule model	Applicable wire (mm ² (AWG))	Crimping tool
Terminals other than ground terminals	Phoenix Contact	A10,34-8	0.34 (#22)	Phoenix Contact (The figure in parentheses is the applicable wire size.) CRIMPFOX 6 (0.25 to 6 mm ² , AWG24 to 10)
		A10,5-8	0.5 (#20)	
		A10,5-10		
		A10,75-8	0.75 (#18)	
		A10,75-10		
		A11,0-8	1.0 (#18)	
		A11,0-10		
		A11,5-8	1.5 (#16)	
A11,5-10				
Ground terminals		A12,5-10	2.0 *1	
Terminals other than ground terminals	Weidmuller	H0.14/12	0.14 (#26)	Weidmuller (The figure in parentheses is the applicable wire size.) PZ6 Roto (0.14 to 6 mm ² , AWG26 to 10)
		H0.25/12	0.25 (#24)	
		H0.34/12	0.34 (#22)	
		H0.5/14	0.5 (#20)	
		H0.5/16		
		H0.75/14	0.75 (#18)	
		H0.75/16		
		H1.0/14	1.0 (#18)	
		H1.0/16		
		H1.5/14	1.5 (#16)	
		H1.5/16		

*1. Some AWG14 wires exceed 2.0 mm² and cannot be used in the screwless clamping terminal block.

When you use any ferrules other than those in the above table, crimp them to the twisted wires so that the following processed dimensions are achieved.

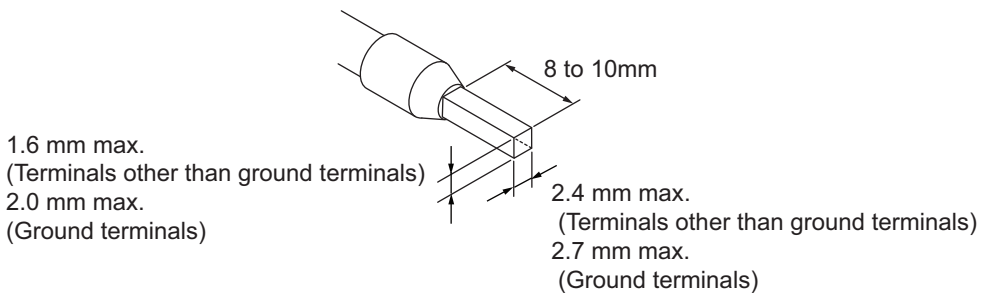

● **Using Twisted Wires/Solid Wires**

If you use twisted wires or solid wires, use the following table to determine the correct wire specifications.

Terminals		Wire type				Wire size	Conductor length (stripping length)
Classification	Current capacity	Twisted wires		Solid wire			
		Plated	Unplated	Plated	Unplated		
All terminals except ground terminals	2 A max.	Possible	Possible	Possible	Possible	0.08 to 1.5 mm ² (AWG 28 to 16)	8 to 10 mm
	Greater than 2 A and 4 A or less			Possible *1	Not possible		
	Greater than 4 A	Possible *1	Not possible	Not possible			
Ground terminals	---	Possible	Possible	Possible *2	Possible *2	2.0 mm ²	9 to 10 mm

*1. Secure wires to the screwless clamping terminal block. Refer to *Securing Wires* on page 4-20 for how to secure wires.

*2. With the NX-TB□□□1 Terminal Block, use twisted wires to connect the ground terminal. Do not use a solid wire.

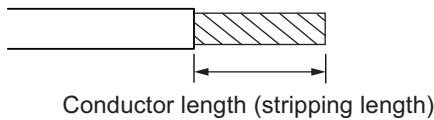

 **Precautions for Correct Use**

- Use cables with suitable wire sizes for the carrying current. There are also restrictions on the current due to the ambient temperature. Refer to the manuals for the cables and use the cables correctly for the operating environment.
- For twisted wires, strip the sheath and twist the conductor portion. Do not unravel or bend the conductor portion of twisted wires or solid wires.

NG

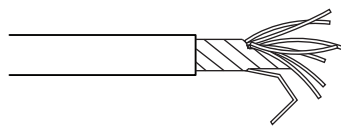

Unravel wires

NG

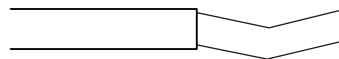

Bend wires

 **Additional Information**

If more than 2 A will flow on the wires, use plated wires or use ferrules.

Connecting/Removing Wires

This section describes how to connect and remove wires.

● Terminal Block Parts and Names

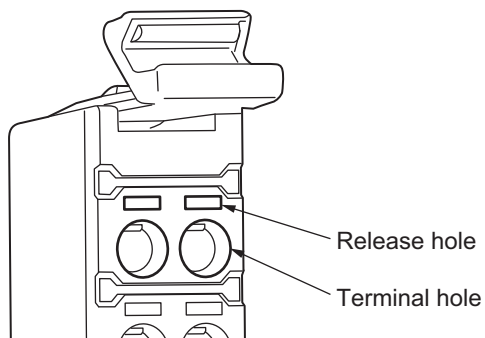

● Required Tools

Use a flat-blade screwdriver to connect and remove wires.

Use the following flat-blade screwdriver.

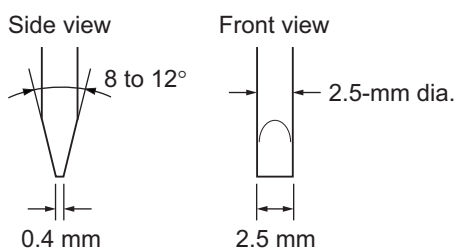

Recommended screwdriver

Model	Manufacturer
SZF 0-0,4×2,5	Phoenix Contact

● Connecting Ferrules

Insert the ferrule straight into the terminal hole.

It is not necessary to press a flat-blade screwdriver into the release hole.

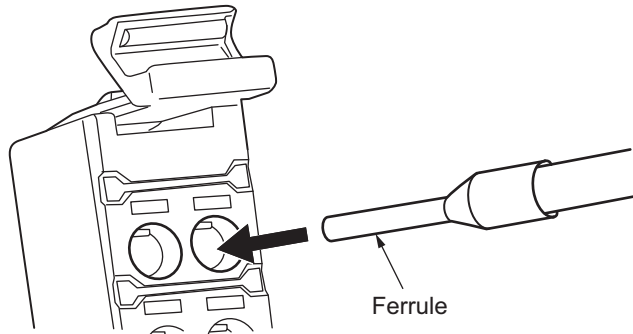

After you make a connection, make sure that the ferrule is securely connected to the terminal block.

● Connecting Twisted Wires/Solid Wires

Use the following procedure to connect the twisted wires or solid wires to the terminal block.

- 1** Press a flat-blade screwdriver diagonally into the release hole.
Press at an angle of 10° to 15° .
If you press in the screwdriver correctly, you will feel the spring in the release hole.

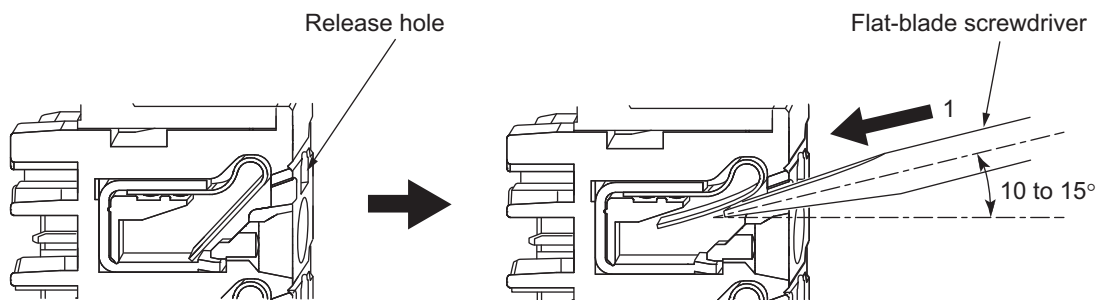

- 2** Leave the flat-blade screwdriver pressed into the release hole and insert the twisted wire or the solid wire into the terminal hole.

Insert the twisted wire or the solid wire until the stripped portion is no longer visible to prevent shorting.

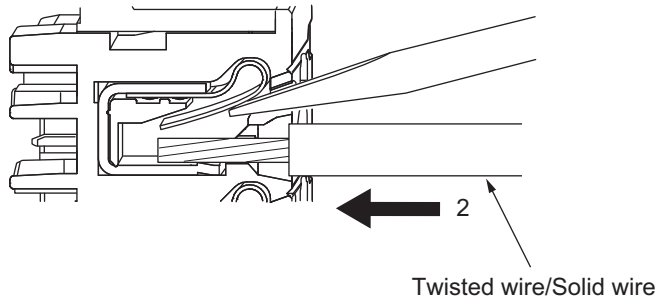

- 3** Remove the flat-blade screwdriver from the release hole.

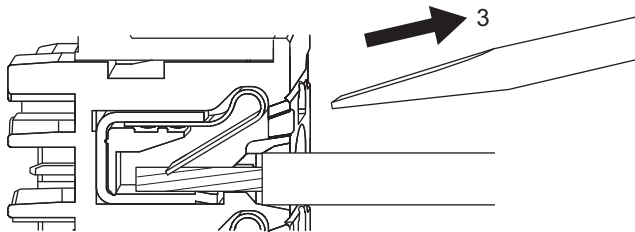

After you make a connection, make sure that the twisted wire or the solid wire is securely connected to the terminal block.



Precautions for Safe Use

- Do not press the flat-blade screwdriver straight into the release hole. Doing so may break the terminal block.

NG

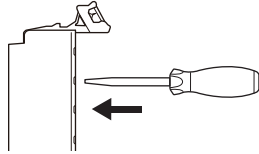

OK

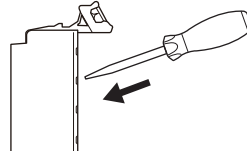

- When you insert a flat-blade screwdriver into a release hole, press it down with a force of 30 N max. Applying excessive force may damage the terminal block.
- Do not tilt or twist the flat-blade screwdriver while it is pressed into the release hole. Doing so may break the terminal block.

NG

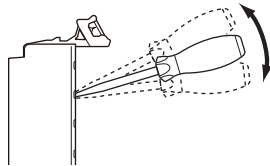

NG

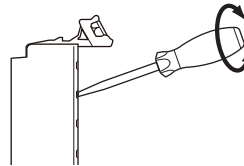

- Make sure that all wiring is correct.
- Do not bend the cable forcibly. Doing so may sever the cable.

● **Securing Wires**

It is necessary to secure wires to the screwless clamping terminal block depending on the wire types that are used or the current flows on the wires.

The following table gives the necessity for securing wires.

Terminals		Wire type				
		Ferrule	Twisted wires		Solid wire	
Classification	Current capacity		Plated	Unplated	Plated	Unplated
All terminals except ground terminals	2 A max.	No	No	No	No	No
	Greater than 2 A and 4 A or less			Not Possible	Yes	Not Possible
	Greater than 4 A		Yes	Not Possible		
Ground terminals	---		No	No	No	No

Use the following procedure to secure the wires.

1 Prepare a cable tie.

A cable tie can be used with a width of 4 mm or less and a thickness of 1.5 mm or less.

Select a cable tie correctly for the operating environment.

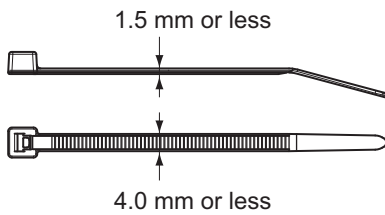

2 Pass a cable tie through the hole for securing wires on the bottom of the screwless clamping terminal block.

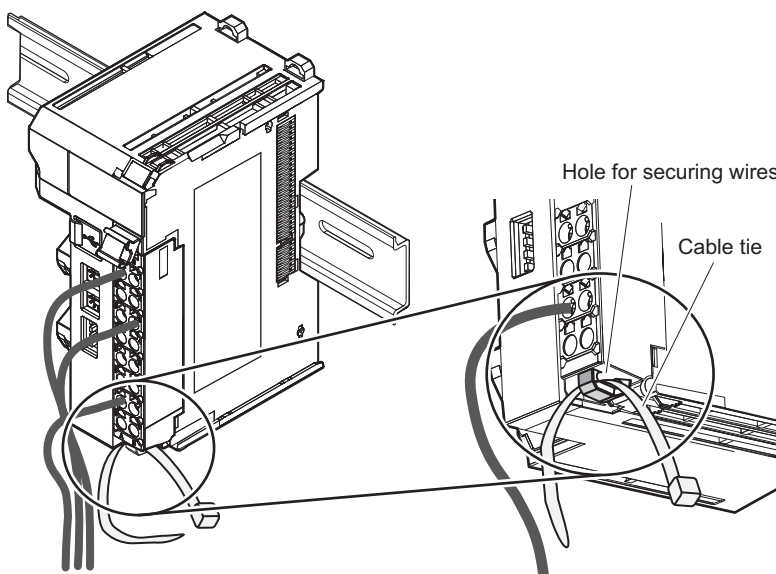

- 3** Bundle the wires with a cable tie and secure them to the screwless clamping terminal block.

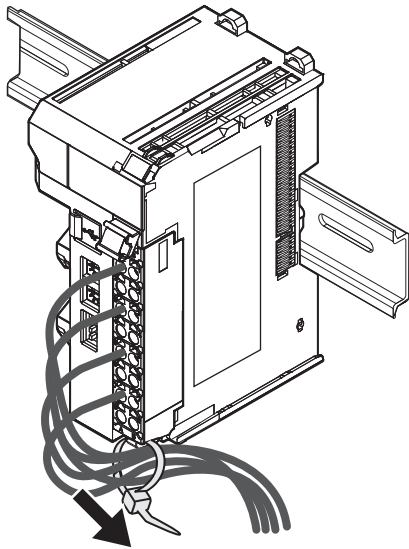

Secure wires within the range of 30 mm from the screwless clamping terminal block.

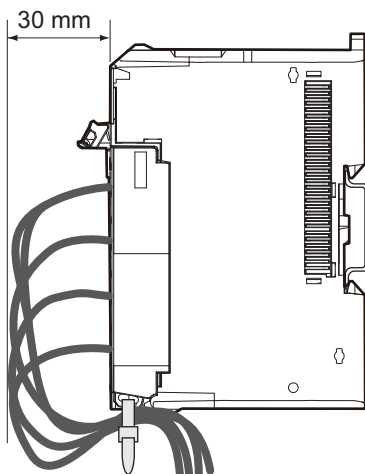

● **Removing Wires**

Use the following procedure to remove the wires from the terminal block.

The removal method is the same for ferrules, twisted wires, and solid wires.

If wires are secured firmly to the terminal block, release them first

- 1** Press the flat-blade screwdriver diagonally into the release hole. Press at an angle of 10° to 15°.

If you press in the screwdriver correctly, you will feel the spring in the release hole.

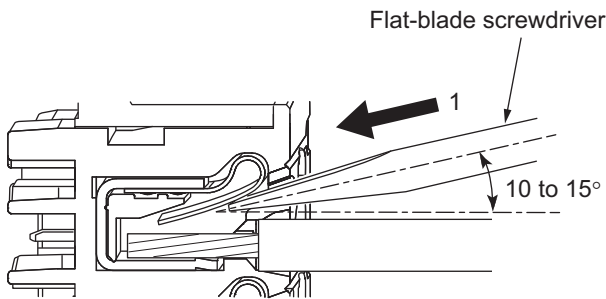

- 2** Leave the flat-blade screwdriver pressed into the release hole and pull out the wire.

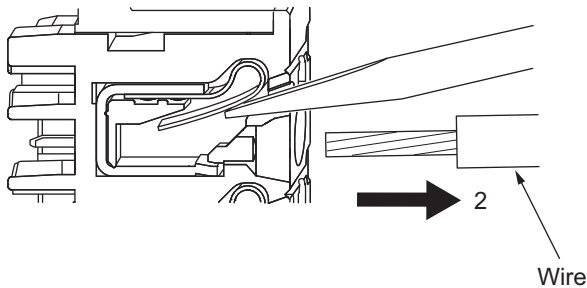

- 3** Remove the flat-blade screwdriver from the release hole.

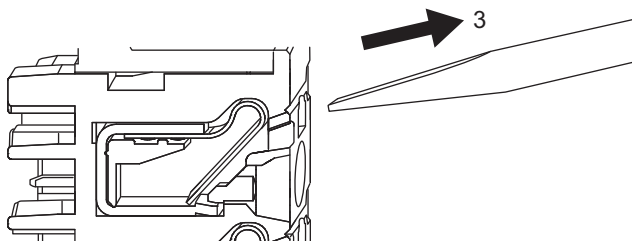



Precautions for Safe Use

- Do not press the flat-blade screwdriver straight into the release hole. Doing so may break the terminal block.

NG

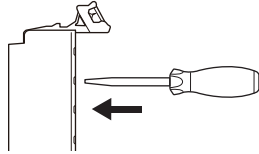

OK

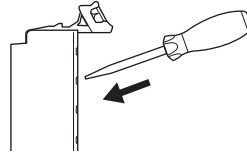

- When you insert a flat-blade screwdriver into a release hole, press it down with a force of 30 N max. Applying excessive force may damage the terminal block.
- Do not tilt or twist the flat-blade screwdriver while it is pressed into the release hole. Doing so may break the terminal block.

NG

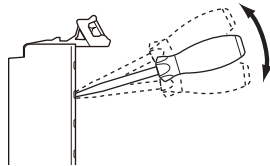

NG

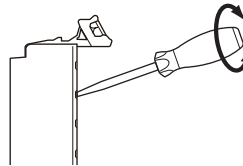

- Make sure that all wiring is correct.
- Do not bend the cable forcibly. Doing so may sever the cable.

Removing a Terminal Block

- 1 Press the lock lever on the terminal block and pull out the top of the terminal block to remove it.

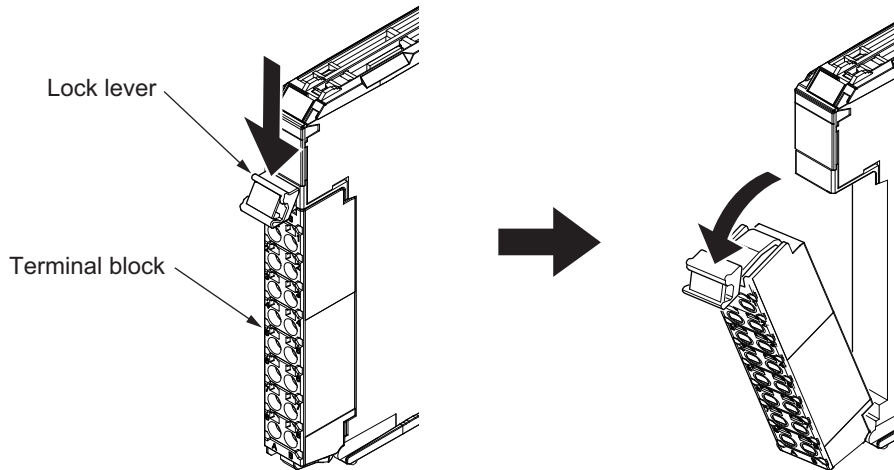

Attaching a Terminal Block

- 1 Mount the terminal block hook on the guide at the bottom of the NX Unit, lift up the terminal block, and press in on the top of the terminal block until you hear it engage.
The terminal block will click into place on the Unit.
After you mount the terminal block, make sure that it is locked to the Unit.

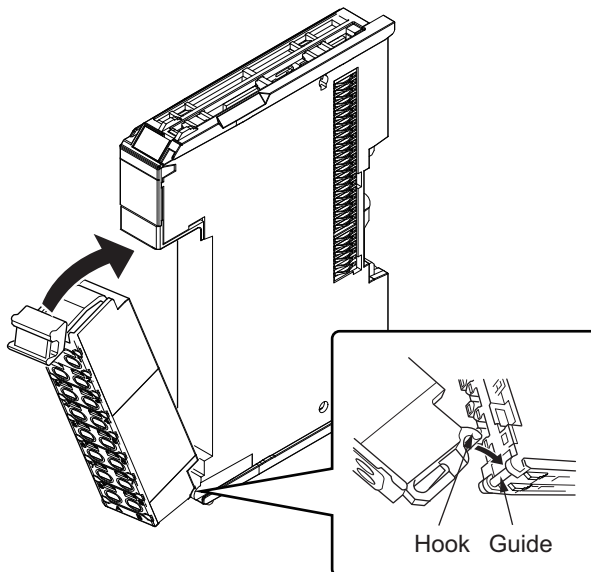

Mount a terminal block that is applicable to each Unit model.

Refer to *Applicable Terminal Blocks for Each Unit Model* on page 3-5 for the applicable terminal blocks.

Preventing Incorrect Attachment of Terminal Blocks

In order to prevent unintentionally installing the wrong terminal block, you can limit the combination of a Unit and a terminal block.

Insert three Coding Pins (NX-AUX02) into three of the six incorrect attachment prevention holes on the Unit and on the terminal block. Insert these pins into positions so that they do not interfere with each other when the Unit and terminal block are connected to each other.

You can use these pins to create a combination in which the wrong terminal block cannot be attached because the pin patterns do not match.

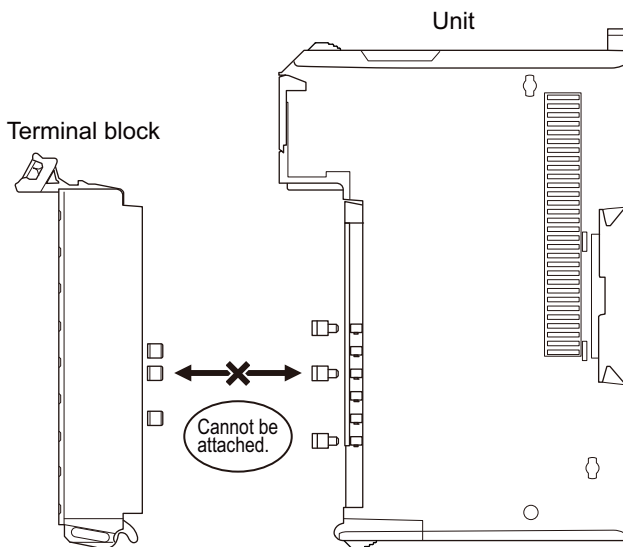

Types of Coding Pins

There are two types of Coding Pins, both with their own unique shape: one for terminal blocks and one for Units.

Three pins come with each runner.

For terminal block

For Unit

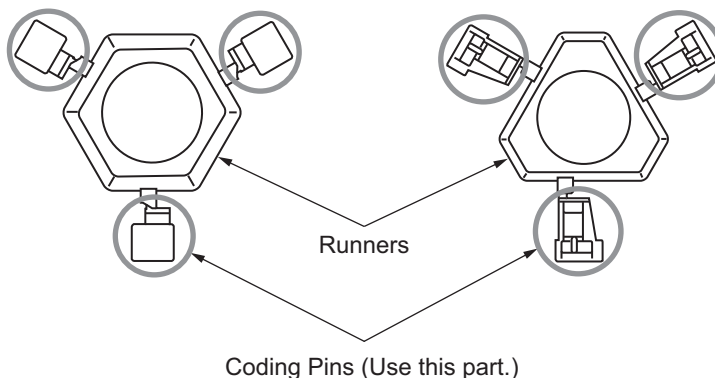

Use the following Coding Pins.

Name	Model	Specification
Coding Pin	NX-AUX02	For 10 Units (Terminal block: 30 pins, Unit: 30 pins)

● Insertion Locations and Patterns of Coding Pins

Insert three Coding Pins of each on the terminal block and on the Unit at the positions designated by the numbers 1 through 6 in the figure below.

As shown in the following table, there are 20 unique pin patterns that can be used.

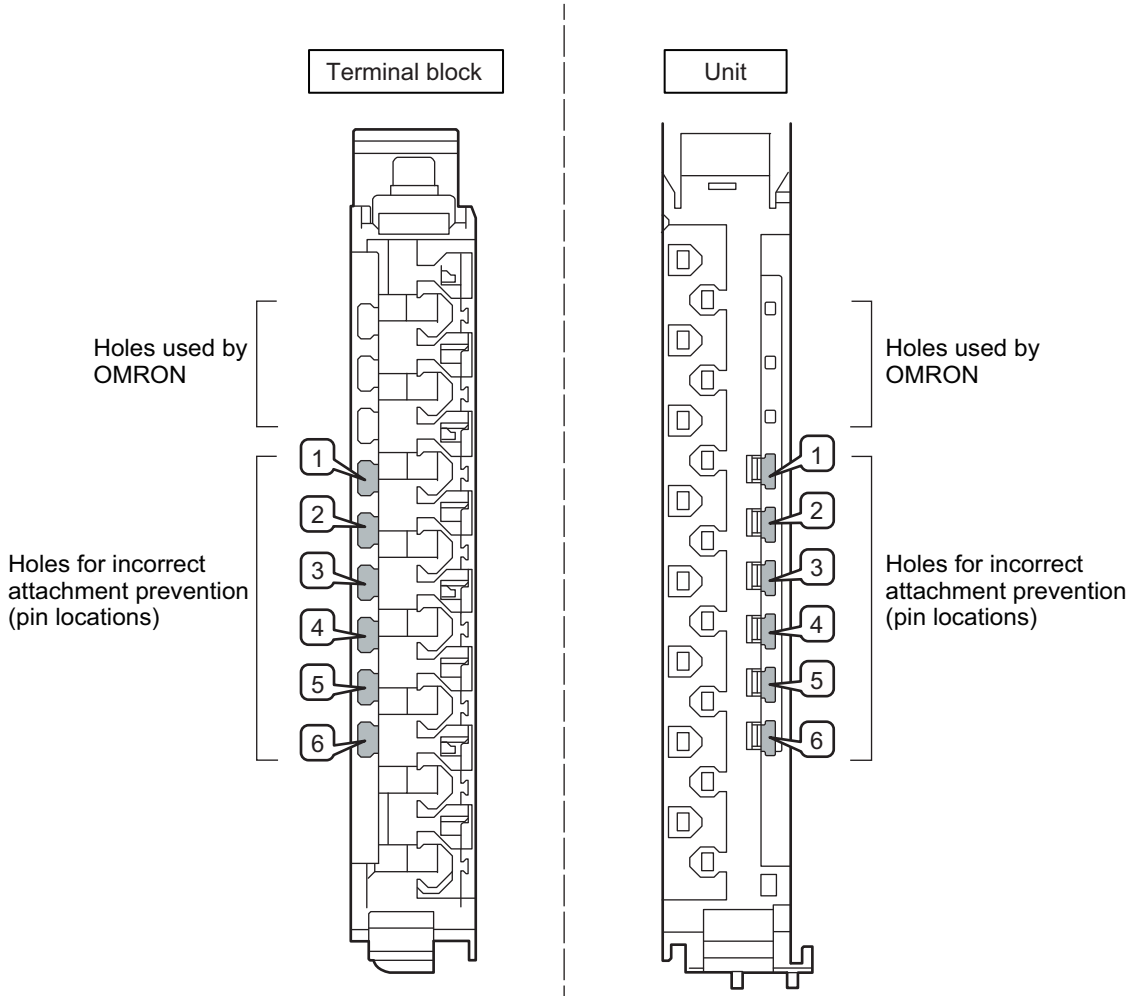

○: Pin inserted

Pattern	Pin locations for terminal block						Pin locations for Unit					
	1	2	3	4	5	6	1	2	3	4	5	6
No.1	○	○	○							○	○	○
No.2	○	○		○					○		○	○
No.3	○	○			○				○	○		○
No.4	○	○				○			○	○	○	
No.5	○		○	○				○			○	○
No.6	○		○		○			○		○		○
No.7	○		○			○		○		○	○	
No.8	○			○	○			○	○			○
No.9	○			○		○		○	○		○	
No.10	○				○	○		○	○	○		
No.11		○	○	○			○				○	○
No.12		○	○		○		○			○		○
No.13		○	○			○	○			○	○	
No.14		○		○	○		○		○			○
No.15		○		○		○	○		○		○	
No.16		○			○	○	○		○	○		
No.17			○	○	○		○	○				○
No.18			○	○		○	○	○			○	
No.19			○		○	○	○	○		○		
No.20				○	○	○	○	○	○			

To make the maximum of 20 patterns, purchase two sets of NX-AUX02 Pins. (One set for 10 Units.)



Precautions for Correct Use

- OMRON uses the holes other than No. 1 to 6 in the figure on the previous page. If you insert a Coding Pin into one of the holes used by OMRON on the terminal block side, this makes it impossible to mount the terminal block on a Unit.
- Do not use Coding Pins that have been attached and removed.

● Inserting the Coding Pins

- 1** Hold the pins by the runner and insert a pin into one of the incorrect attachment prevention holes on the terminal block or on the Unit.

Terminal block

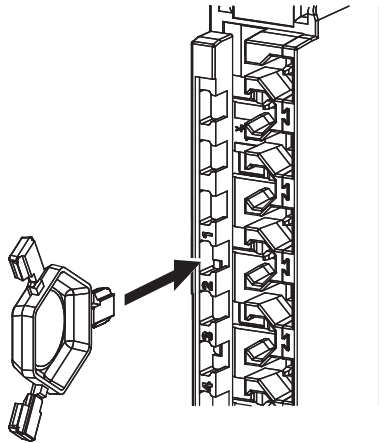

Unit

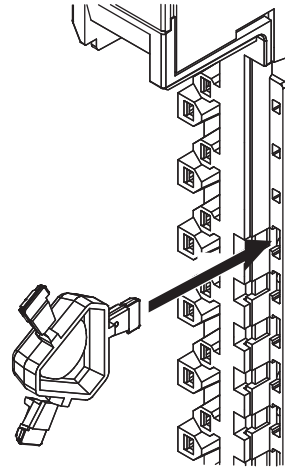

- 2** Rotate the runner to break off the Coding Pins.

Terminal block

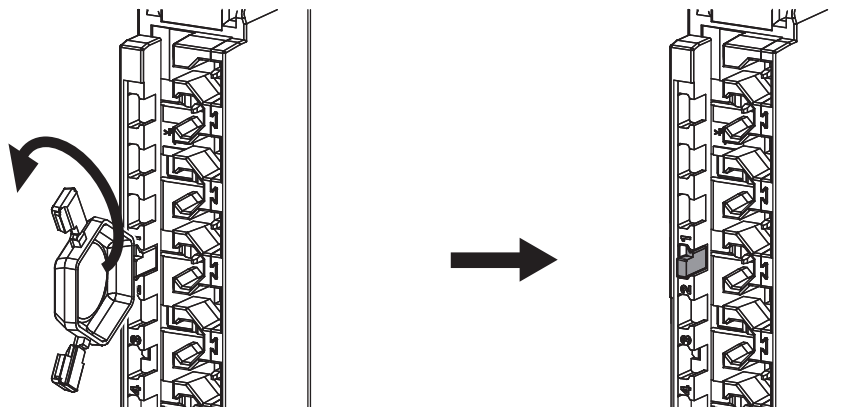

Unit

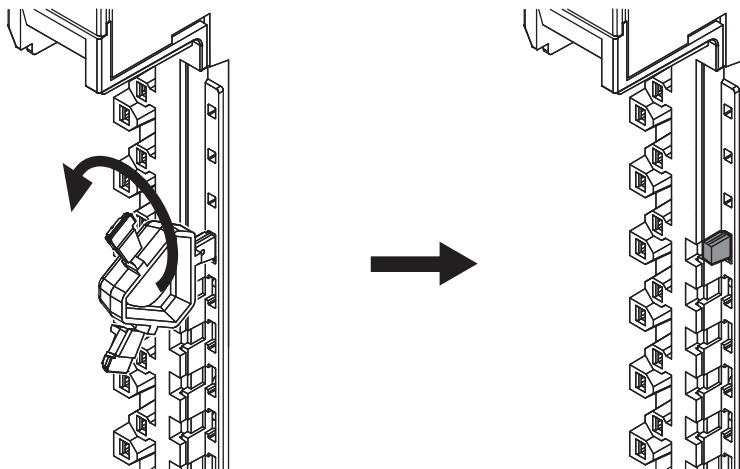

4-3-2 Checking the Wiring

Check the wiring by reading input data or writing output data from Slave Terminals using the Watch Tab Page of the Support Software.

For Input Units, you can turn ON/OFF the inputs from external devices that are connected to the target Units and monitor the results.

For Output Units, you can execute the I/O outputs of the target Units and check the operation of the connected external devices.

For details on monitoring and I/O output operations using the Support Software, refer to the operation manual for the Support Software that you are using.



Additional Information

- In the Sysmac Studio, you can check the wiring from the I/O Map or Watch Tab Page. If you use the I/O Map, you can also monitor and perform forced refreshing even if the variables are not defined or the algorithms are not created. Therefore, you can easily check the wiring. Refer to the *Sysmac Studio Version 1 Operation Manual* (Cat. No. W504) for details on monitoring and forced refreshing operations.
- Some Communications Coupler Units support I/O checking that allows you to check wiring with only the Slave Terminal. Refer to the user's manual of the Communications Coupler Unit for detailed information on the support and functionality of I/O checking for your Communications Coupler Unit.

4-4 Wiring Examples

This section gives wiring examples for the Analog Input Units and Analog Output Units and precautions for wiring.

For the terminal array for each model, refer to the terminal connection diagram for each model in A-1 *Data Sheet* on page A-2.

4-4-1 Wiring the Analog Input Units

● Wiring Example 1 (Input method: Single-ended input)

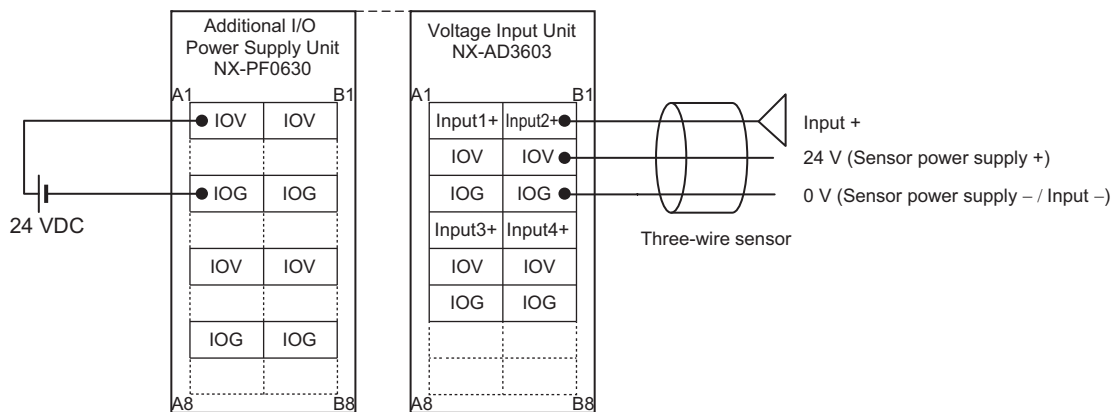

● Wiring Example 2 (Input method: Differential input)

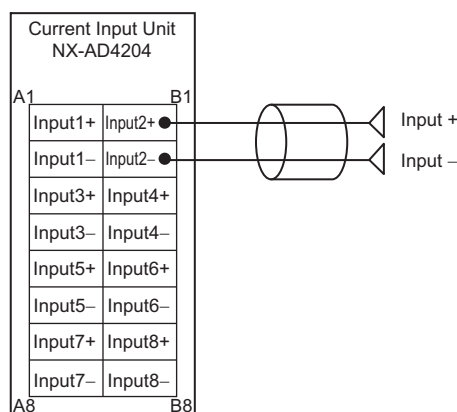

It is not necessary to connect the shield normally. However, if noise affects the Unit, ground the end of the shield on the Input Unit side. In this case, do not connect the end of the shield anywhere on output device.

You can use the NX-TBX01 Shield Connection Unit to ground more than one shield.

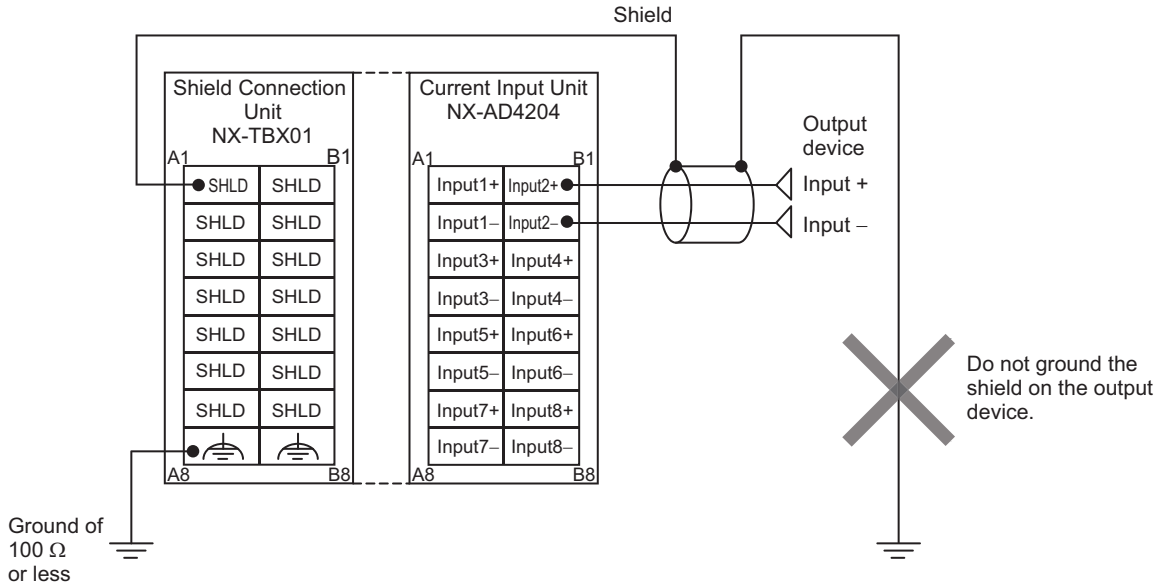

Connect the shield of the cable to the SHLD terminal. And ground the functional ground terminal to 100 Ω or less.



Precautions for Correct Use

To ensure this NX Unit is kept in the best operating condition, observe the following points when wiring to avoid the effects of the noise.

- Use a shield wire (2 conductors, twisted wire) or a shield wire (3 conductors) as the input connection line for each input. Use the shield without connecting to anything normally.
- Wire the input connection lines and power lines (e.g., AC power supply lines or power lines) separately. Do not place such lines in the same duct.
- Insert a noise filter into the power supply input section if noise comes from power supply lines when using the same power supply to power an electrical welder or an electric discharge machine, or there is a high-frequency source nearby.

4-4-2 Wiring the Analog Output Units

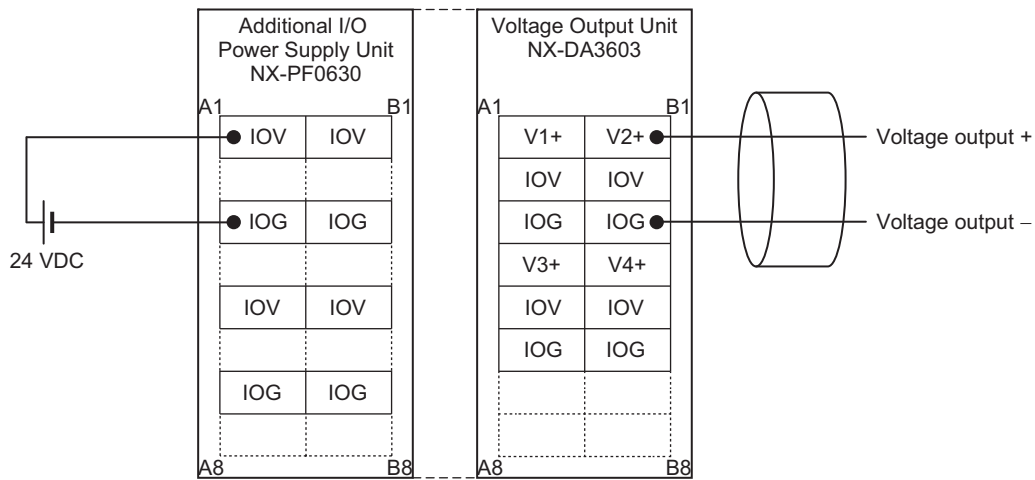

Precautions for Correct Use

To ensure this NX Unit is kept in the best operating condition, observe the following points when wiring to avoid the effects of the noise.

- Use a shield wire (2 conductors, twisted wire) or a shield wire (3 conductors) as the input connection line for each output. Connect the shield according to the specifications of the input device.
- Wire the output connection lines and power lines (e.g., AC power supply lines or power lines) separately. Do not place such lines in the same duct.
- Insert a noise filter into the power supply input section if noise comes from power supply lines when using the same power supply to power an electrical welder or an electric discharge machine, or there is a high-frequency source nearby.

4-4-3 Precautions when Using Common Power Supply for Input Devices of Analog Input Units

If you use Analog Input Units that take differential input, when more than one input device is using the same power supply, and voltage input is being supplied, a disconnection will occur as follows.

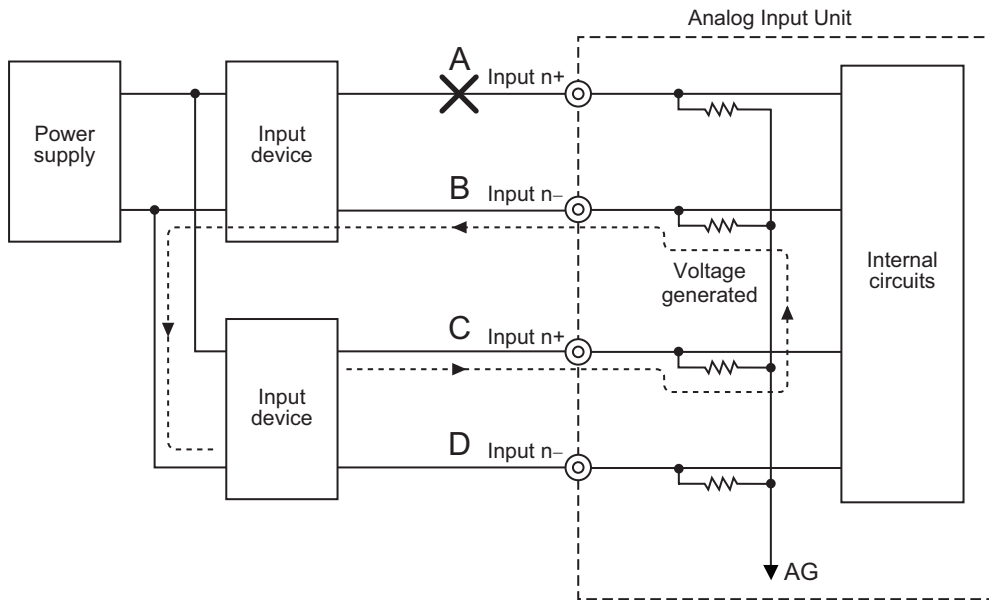

If a disconnection occurs in section A in the figure above, unwanted voltage paths occur as indicated by the arrow. As a result, about 1/3 to 1/2 of the voltage between C and D, which is normally connected, is generated between A and B. The same applies when B is disconnected.

When this kind of voltage is generated, disconnection detection may not work.

When voltage input is being supplied, either set up the input devices so that they are not using the same power supply, or use isolators for each input.

This does not apply when current input is being supplied.

5

I/O Refreshing

This section describes the types and functions of I/O refreshing for the NX Units.

5-1 I/O Refreshing	5-2
5-1-1 I/O Refreshing from CPU Units to NX Units	5-2
5-1-2 I/O Refreshing from CPU Units or Industrial PCs to Slave Terminal	5-3
5-1-3 I/O Refreshing from the Communication Control Unit to NX Units	5-4
5-1-4 Calculating the I/O Response Times of NX Units	5-5
5-2 I/O Refreshing Methods	5-6
5-2-1 Types of I/O Refreshing Methods	5-6
5-2-2 Setting the I/O Refreshing Methods	5-8
5-2-3 Selecting NX Units	5-9
5-2-4 Free-Run Refreshing	5-9
5-2-5 Synchronous Input Refreshing	5-13
5-2-6 Synchronous Output Refreshing	5-17

5-1 I/O Refreshing

This section describes I/O refreshing for NX Units.

5-1-1 I/O Refreshing from CPU Units to NX Units

An NX-series CPU Unit cyclically performs I/O refreshing with the NX Units.

The following period and two cycles affect operation of the I/O refreshing between the CPU Unit and the NX Units.

- (a) Primary period in CPU Unit
- (b) Refresh cycle of the NX bus
- (c) Refresh cycle of each NX Unit

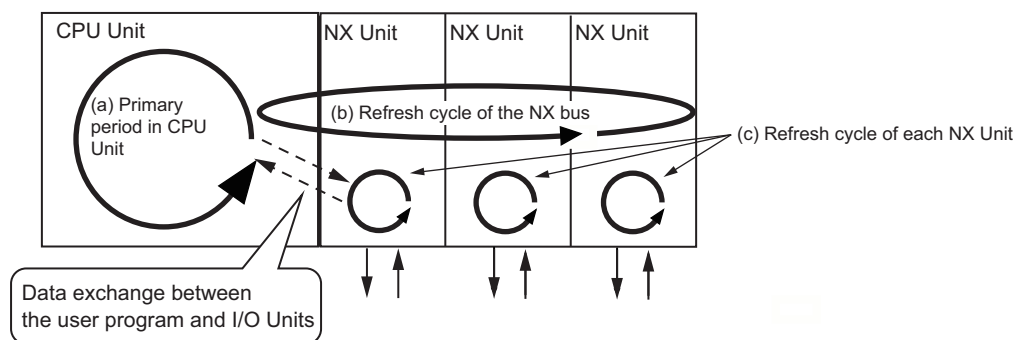

The following operation occurs.

- The refresh cycle of the NX bus in item (b) is automatically synchronized with the primary period of the CPU Unit in item (a).
- The refresh cycle of each NX Unit in item (c) depends on the I/O refreshing method which is given below.

Refer to the *NJ/NX-series CPU Unit Software User's Manual* (Cat. No. W501) for detailed information on I/O refreshing between the CPU Unit and the NX Units.

Refer to *5-1-4 Calculating the I/O Response Times of NX Units* on page 5-5 for the I/O response times of NX Units in the CPU Rack of the CPU Unit.

5-1-2 I/O Refreshing from CPU Units or Industrial PCs to Slave Terminal

The CPU Unit or Industrial PC cyclically performs I/O refreshing with the Slave Terminal through the Communications Master and Communications Coupler Units.

The following four cycles affect operation of the I/O refreshing between the NX Unit on a Slave Terminal and the CPU Unit or Industrial PC.

- (a) Cycle time of the CPU Unit or Industrial PC
- (b) Communications cycle of the host network
- (c) Refresh cycle of the NX bus
- (d) Refresh cycle of each NX Unit

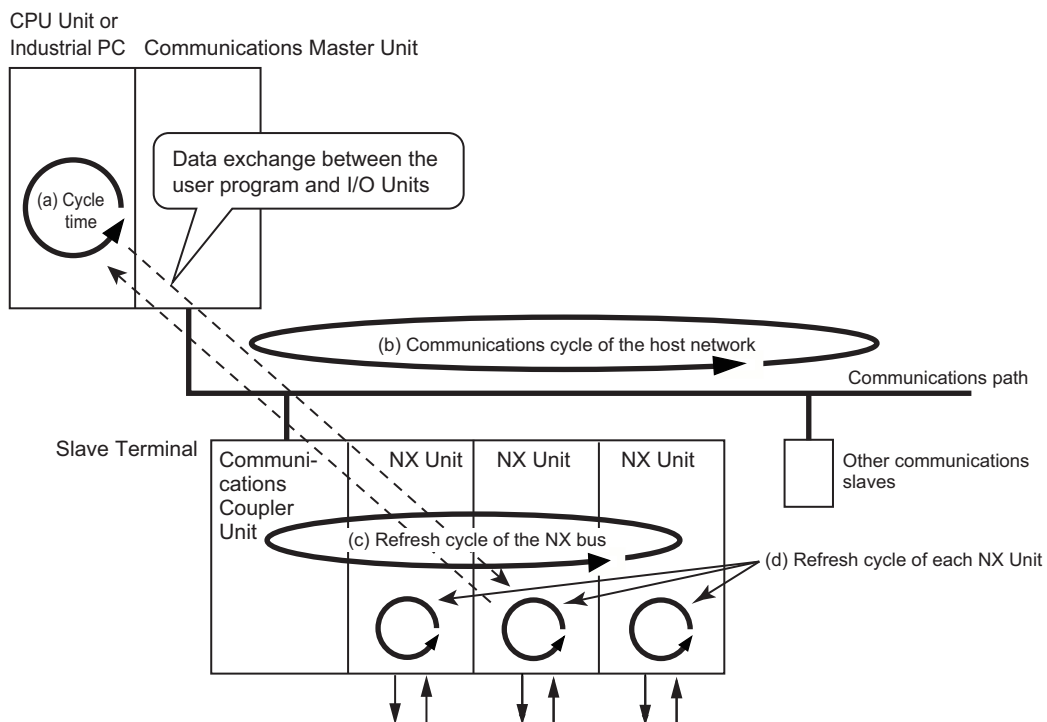

The cycle time of the CPU Unit or Industrial PC and communications cycle of the host network and the I/O refresh cycle of the NX bus are determined by the CPU Unit or Industrial PC types and the communications types.

The following explains operations when the built-in EtherCAT port on the NJ/NX-series CPU Unit or NY-series Industrial PC is used for communications with an EtherCAT Slave Terminal, with symbols in the figure.

Refer to the user's manual for the connected Communications Coupler Unit for details on the operation of I/O refreshing on Slave Terminals other than EtherCAT Slave Terminals.

Operation of I/O Refreshing with NX-series CPU Units

The following shows the operation of I/O refreshing when the built-in EtherCAT port on the NX-series CPU Unit is used for communications with an EtherCAT Slave Terminal.

- The process data communications cycle in item (b) and the refresh cycle of the NX bus in item (c) are automatically synchronized with the primary period or the task period of the priority-5 periodic task of the CPU Unit in item (a).^{*1}
- The refresh cycle of each NX Unit in item (d) depends on the I/O refreshing method which is given below.

*1. This applies when the distributed clock is enabled in the EtherCAT Coupler Unit.

The priority-5 periodic task must be supported by the connected CPU Unit model. Refer to the *NJ/NX-series CPU Unit Software User's Manual* (Cat. No. W501) for the periodic tasks supported by each model of NX-series CPU Unit.

Operation of I/O Refreshing with NJ-series CPU Units or NY-series Industrial PCs

The following shows the operation of I/O refreshing when the built-in EtherCAT port on the NJ-series CPU Unit or NY-series Industrial PC is used for communications with an EtherCAT Slave Terminal.

- The process data communications cycle in item (b) and the refresh cycle of the NX bus in item (c)^{*1} are automatically synchronized with the primary period of the CPU Unit or Industrial PC in item (a).
- The refresh cycle of each NX Unit in item (d) depends on the I/O refreshing method which is given below.

*1. This applies when the distributed clock is enabled in the EtherCAT Coupler Unit.

Refer to the *NX-series EtherCAT Coupler Unit User's Manual* (Cat. No. W519) for detailed information on I/O refreshing between the built-in EtherCAT port and EtherCAT Slave Terminals.

Refer to 5-1-4 *Calculating the I/O Response Times of NX Units* on page 5-5 for the I/O response times of NX Units on Slave Terminals.

5-1-3 I/O Refreshing from the Communication Control Unit to NX Units

Refer to the user's manual for the Communication Control Unit for details on I/O refreshing from the Communication Control Unit to NX Units.

5-1-4 Calculating the I/O Response Times of NX Units

Depending on where the NX Unit is connected, refer to the following manuals to calculate the I/O response times of an NX unit.

Connected to a CPU Unit

Manual to reference	Description
Software user's manual for the connected CPU Unit	The method for calculating the I/O response times of NX Units in the CPU Rack with a CPU Unit is described.
NX-series Data Reference Manual	The NX Unit parameter values used for calculating the I/O response times of NX Units are described.

Connected to a Communications Coupler Unit

Manual to reference	Description
User's manual for the connected Communications Coupler Unit	The method for calculating the I/O response times of NX Units on Slave Terminals is described.
NX-series Data Reference Manual	The NX Unit parameter values used for calculating the I/O response times of NX Units are described.

Connected to a Communication Control Unit

Manual to reference	Description
User's manual for the connected Communication Control Unit	The method for calculating the I/O response times of NX Units in the CPU Rack with a Communication Control Unit is described.
NX-series Data Reference Manual	The NX Unit parameter values used for calculating the I/O response times of NX Units are described.

5-2 I/O Refreshing Methods

This section describes I/O refreshing methods for the NX Units.

5-2-1 Types of I/O Refreshing Methods

Methods of I/O Refreshing between the CPU Unit and NX Units

The I/O refreshing methods that you can use between the CPU Unit and the NX Units depend on the connected CPU Unit.

Refer to the software user's manual for the connected CPU Unit for information on the I/O refreshing methods that you can use between the CPU Unit and the NX Units.

As an example, the I/O refreshing methods that you can use between the NX-series NX1P2 CPU Unit and the NX Units are shown below.

I/O refreshing method name ^{*1}	Outline of operation
Free-Run refreshing	With this I/O refreshing method, the refresh cycle of the NX bus and I/O refresh cycles of the NX Units are asynchronous.
Synchronous I/O refreshing	With this I/O refreshing method, the timing to read inputs or to refresh outputs is synchronized on a fixed interval between more than one NX Unit connected to a CPU Unit.
Time stamp refreshing	With this I/O refreshing method, the NX Units record the DC times when inputs change or perform outputs at specified DC times. These times are asynchronous to the NX bus refresh cycles. Data exchange between the NX Units and CPU Unit are performed cyclically on the NX bus refresh cycles.
Input refreshing with input changed time	With this I/O refreshing method, the Input Units record the DC times when inputs changed.
Output refreshing with specified time stamp	With this I/O refreshing method, the Output Units refresh outputs at specified DC times.

*1. Task period prioritized refreshing cannot be used for the NX1P2 CPU Unit.

Since the NX1P2 CPU Unit can execute all I/O refreshing methods at the same time, you can use NX Units with different I/O refreshing methods together.

Methods of I/O Refreshing between the Communications Coupler Unit and NX Units

The I/O refreshing methods that you can use between the Communications Coupler Unit and the NX Units depend on the Communications Coupler Unit that is used.

Refer to the user's manual for the connected Communications Coupler Unit for information on the I/O refreshing methods that you can use between the Communications Coupler Unit and the NX Units.

As an example, when an EtherCAT Coupler Unit is connected to the built-in EtherCAT port on an NJ/NX-series CPU Unit or NY-series Industrial PC, the I/O refreshing methods that you can use between the EtherCAT Coupler Unit and the NX Units are shown below.

I/O refreshing method name	Outline of operation
Free-Run refreshing	With this I/O refreshing method, the refresh cycle of the NX bus and the I/O refresh cycles of the NX Units are asynchronous.
Synchronous I/O refreshing	With this I/O refreshing method, the timing to read inputs or to refresh outputs is synchronized on a fixed interval between more than one NX Unit on more than one Slave Terminal.
Time stamp refreshing ^{*1}	With this I/O refreshing method, the NX Units record the DC times when inputs change or perform outputs at specified DC times. These times are asynchronous to the NX bus refresh cycles. Data exchange between the NX Units and EtherCAT Coupler Unit are performed cyclically on the NX bus refresh cycles.
Input refreshing with input changed time	With this I/O refreshing method, the Input Units record the DC times when inputs changed.
Output refreshing with specified time stamp	With this I/O refreshing method, the Output Units refresh outputs at specified DC times.
Task period prioritized refreshing ^{*2}	With this I/O refreshing method, shortening the task period is given priority over synchronizing the I/O timing with other NX Units. With this I/O refreshing method, the timing of I/O is not consistent with the timing of I/O for NX Units that use synchronous I/O refreshing.

*1. Neither the Analog Input Unit nor Analog Output Unit supports time stamp refreshing.

*2. Necessary to use an EtherCAT Coupler Unit NX-ECC203. Neither the Analog Input Unit nor Analog Output Unit supports task period prioritized refreshing.

Since the EtherCAT Coupler Unit can execute all I/O refreshing methods at the same time, you can use NX Units with different I/O refreshing methods together in the EtherCAT Slave Terminal.

Methods of I/O Refreshing between the Communication Control Unit and NX Units

Refer to the user's manual for the connected Communication Control Unit for information on the I/O refreshing methods that you can use between the Communication Control Unit and the NX Units.

5-2-2 Setting the I/O Refreshing Methods

Setting Methods between the CPU Unit and the NX Units

How to set an I/O refreshing method between the CPU Unit and the NX Units is determined by the connected CPU Unit.

Refer to the software user's manual for the connected CPU Unit for information on how to set an I/O refreshing method between the CPU Unit and the NX Units.

An example of the setting operation for the NX-series NX1P2 CPU Unit is shown below. For the NX1P2 CPU Unit, no setting operation is required, and the method is determined according to the following table.

NX Units that support only Free-Run refreshing	NX Units that support both Free-Run refreshing and synchronous I/O refreshing	NX Units that support Free-Run refreshing, synchronous I/O refreshing, and task period prioritized refreshing	NX Units that support only time stamp refreshing ^{*1}
Free-Run refreshing	Synchronous I/O refreshing		Time stamp refreshing

*1. Two types of time stamp refreshing are available: one is input refreshing with input changed time and the other is output refreshing with specified time stamp.

Setting Methods between the Communications Coupler Unit and the NX Units

How to set an I/O refreshing method between the Communications Coupler Unit and the NX Units is determined by the connected Communications Coupler Unit.

Refer to the user's manual for the connected Communications Coupler Unit for information on how to set an I/O refreshing method between the Communications Coupler and the NX Units.

An example when the EtherCAT Coupler Unit is connected to the built-in EtherCAT port on an NJ/NX-series CPU or NY-series Industrial PC is shown below.

The I/O refreshing method between the EtherCAT Coupler Unit and each NX Unit depends on whether the DC is enabled in the EtherCAT Coupler Unit.

DC enable setting in the EtherCAT Coupler Unit	NX Units that support only Free-Run refreshing	NX Units that support both Free-Run refreshing and synchronous I/O refreshing	NX Units that support Free-Run refreshing, synchronous I/O refreshing, and task period prioritized refreshing	NX Units that support only time stamp refreshing ^{*1}
Enabled (DC for synchronization) ^{*2}	Free-Run refreshing	Synchronous I/O refreshing	Synchronous I/O refreshing	Time stamp refreshing
Enabled (DC with priority in cycle time) ^{*2}			Task period prioritized refreshing	
Disabled (FreeRun) ^{*3}		Free-Run refreshing	Free-Run refreshing	Operation with time stamp refreshing is not possible. ^{*4}

- *1. Two types of time stamp refreshing are available: one is input refreshing with input changed time and the other is output refreshing with specified time stamp.
- *2. The EtherCAT Slave Terminal operates in DC Mode.
- *3. The EtherCAT Slave Terminal operates in Free-Run Mode.
- *4. Refer to the manuals for the specific NX Units for details on the operation when the DC is set to *Disabled (FreeRun)*.

Setting Methods between the Communication Control Unit and the NX Units

Refer to the user's manual for the connected Communication Control Unit for information on how to set an I/O refreshing method between the Communication Control Unit and the NX Units.

5-2-3 Selecting NX Units

The I/O refreshing methods that you can use depend on the model of the NX Unit. After you decide on which I/O refreshing method to use, select the NX Units.

5-2-4 Free-Run Refreshing

With this I/O refreshing method, the refresh cycle of the NX bus and I/O refresh cycles of the NX Units are asynchronous.

NX Units read inputs or refresh outputs at the time of I/O refreshing.

This method is used when it is not necessary to be aware of factors such as the I/O timing jitter and the concurrency of the timing to read inputs and refresh outputs between the NX Units.

This section explains operations when NX Units are connected to a CPU Unit or Communications Coupler Unit.

Refer to the user's manual for the Communication Control Unit for operations when NX Units are connected to a Communication Control Unit.

Description of CPU Unit Operation

The following describes the operation of Free-Run refreshing between an NX-series CPU Unit and the NX Units.

- The CPU Unit performs I/O refreshing for NX Units. (Refer to (a) in the figure below.)
- The NX Units read inputs or refresh outputs at the time of I/O refreshing. (Refer to (b) in the figure below.)
- The CPU Unit can read the most recent input value at the I/O refreshing and the NX Units can control with the most recent output value at the I/O refreshing. However, timing to read inputs or to refresh outputs for each NX Unit does not occur at the same time. (Refer to (c) in the figure below.)
- The interval of I/O refreshing varies with the processing conditions of the CPU Unit. Therefore, the interval of the timing to read inputs or to refresh outputs for NX Unit is not always the same. (Refer to (d) in the figure below.)

● Inputs

- The Analog Input Units repeatedly perform AD conversion in the order of inputs for which the used channels are set to enable. AD conversion is not synchronized with I/O refreshing of the NX bus.
- At the time of I/O refreshing, the CPU Unit reads the converted values from the NX Unit for one Unit that AD conversion is complete before the timing to read inputs.

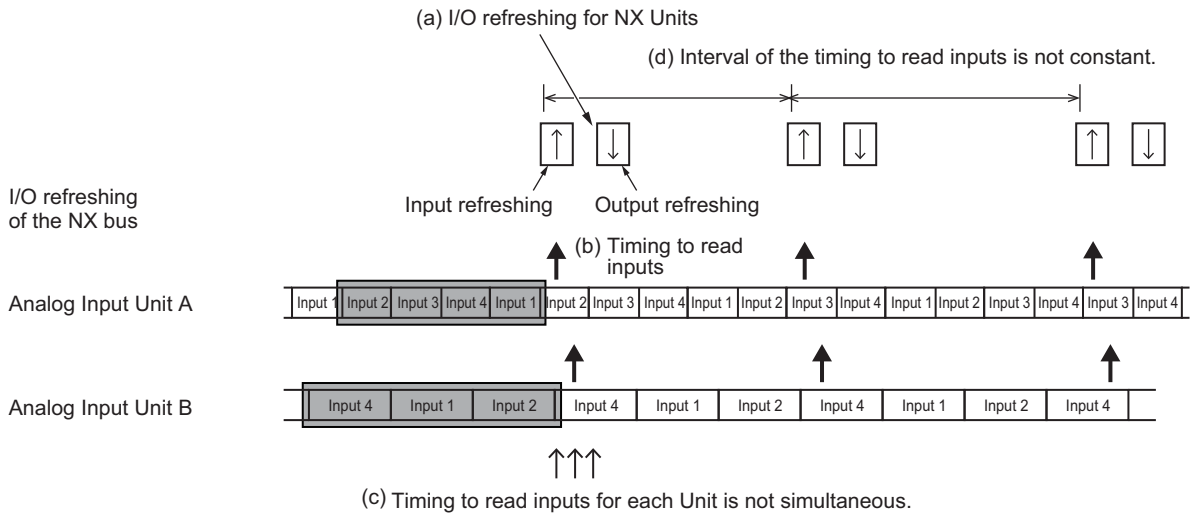

● Outputs

- The Analog Output Units repeatedly perform DA conversion in the order of outputs for which the used channels are set to enable. The outputs are refreshed once per DA conversion cycle for one Unit when DA conversion of the last output is complete. The refreshing is not synchronized with I/O refreshing of the NX bus.
- At the time of I/O refreshing, the Analog Output Units perform DA conversion with the refreshed output set values from the outputs before the start of conversion.

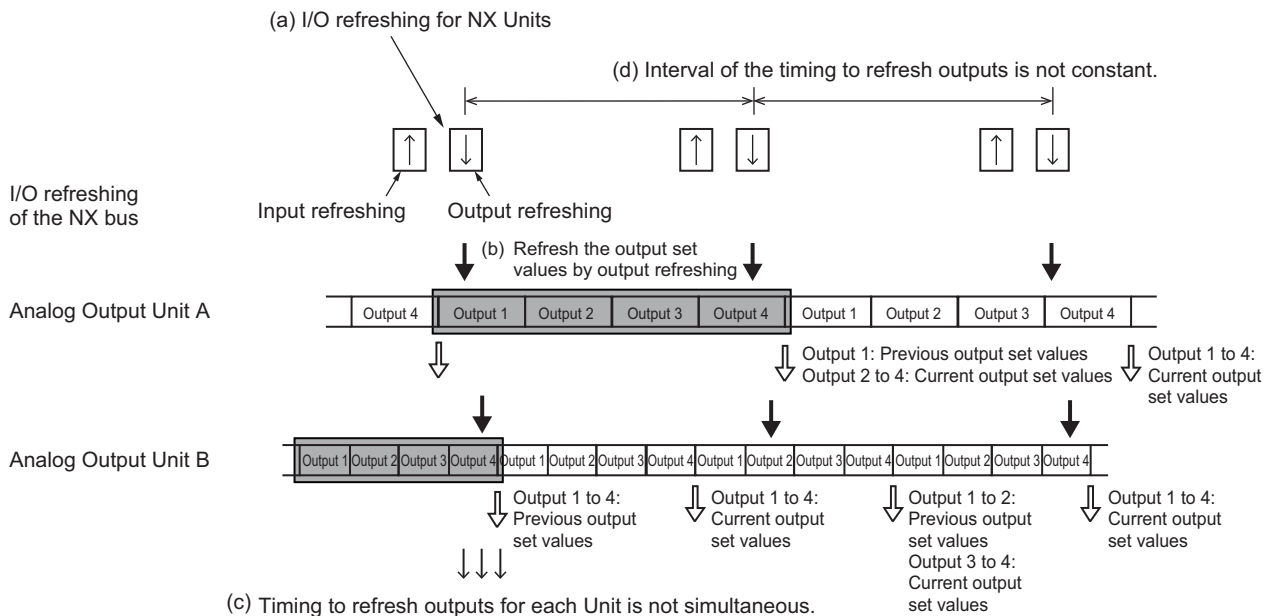

Description of Slave Terminal Operation

- The Communications Coupler Unit performs I/O refreshing for NX Units. (Refer to (a) in the figure below.)
- The NX Units read inputs or refresh outputs at the time of I/O refreshing. (Refer to (b) in the figure below.)
- The Communications Coupler Unit can read the most recent input value at the time of I/O refreshing and the NX Units can control the most recent output value at the time of I/O refreshing. However, the timing to read inputs or to refresh outputs for each NX Unit in the Slave Terminal does not occur at the same time. (Refer to (c) in the figure below.)
- The interval of I/O refreshing varies with the processing conditions of the Communications Coupler Unit or the host communications master. Therefore, the interval of the timing to read inputs or to refresh outputs for NX Units is not always the same. (Refer to (d) in the figure below.)

Inputs

- The Analog Input Units repeatedly perform AD conversion in the order of inputs for which the used channels are set to enable. AD conversion is not synchronized with I/O refreshing of the NX bus.
- At the time of I/O refreshing, the Communications Coupler Unit reads the converted values from the NX Unit for one Unit that AD conversion is complete before the timing to read inputs.

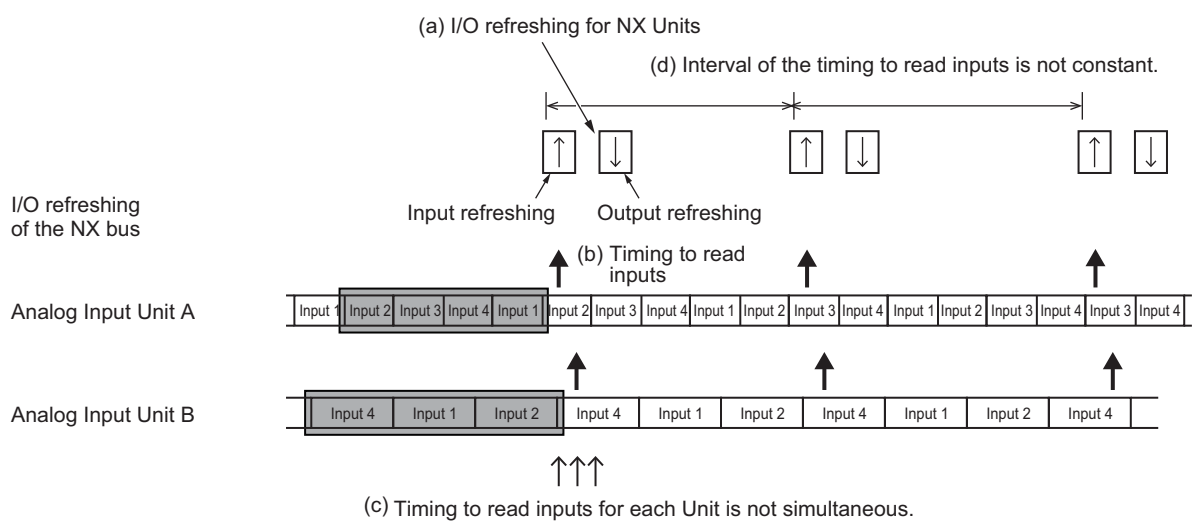

● **Outputs**

- The Analog Output Units repeatedly perform DA conversion in the order of outputs for which the used channels are set to enable. The outputs are refreshed once per DA conversion cycle for one Unit when DA conversion of the last output is complete. The refreshing is not synchronized with I/O refreshing of the NX bus.
- At the time of I/O refreshing, the Analog Output Units perform DA conversion with the refreshed output set values from the outputs before the start of conversion.

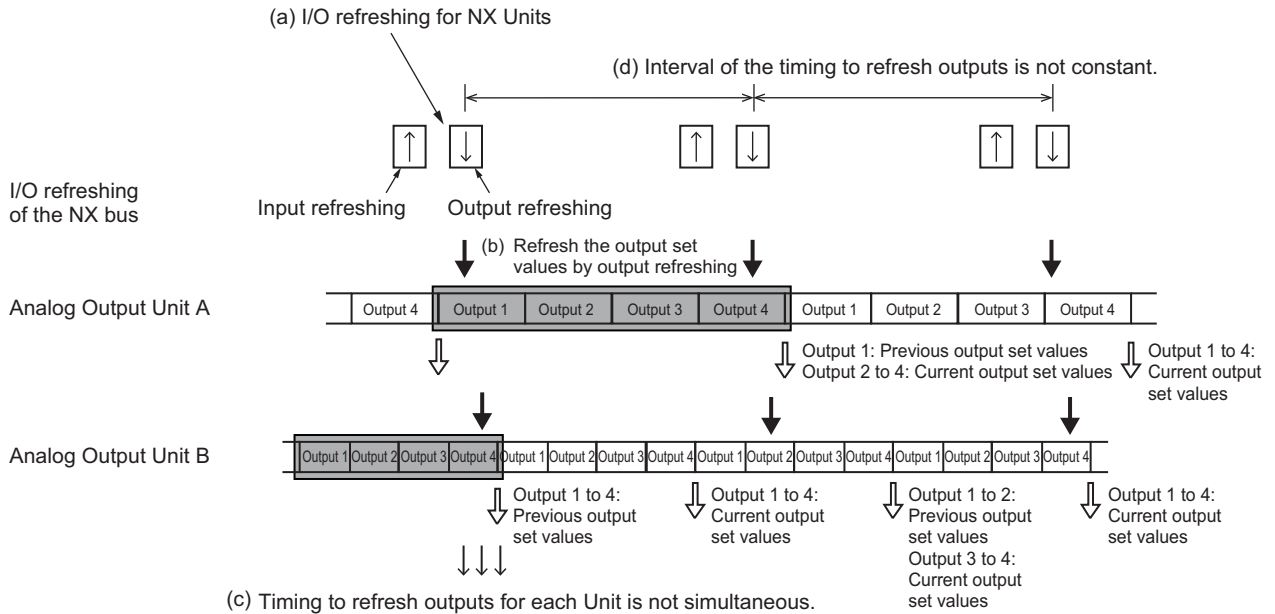

Settings

Add NX Units that support Free-Run refreshing to the CPU Unit configuration or Slave Terminal configuration.

After you add the NX Units, set an I/O refreshing method depending on the connected CPU Unit or Communications Coupler Unit so that these NX Units operate with Free-Run refreshing.

Refer to 5-2-2 *Setting the I/O Refreshing Methods* on page 5-8 for the setting procedure of the I/O refreshing method.

5-2-5 Synchronous Input Refreshing

The I/O refreshing method described below. Among Slave Terminals, only EtherCAT Slave Terminals support this refreshing method.

- The timing to read inputs is synchronized on a fixed interval between more than one NX Unit connected to a CPU Unit.
- The timing to read inputs is synchronized on a fixed interval between more than one NX Unit on more than one Slave Terminal.

This method is used when the problem such as input timing jitter or offset of timing to read inputs between more than one NX Unit happens.

This section explains operations when NX Units are connected to a CPU Unit or Communications Coupler Unit.

Refer to the user's manual for the Communication Control Unit for operations when NX Units are connected to a Communication Control Unit.

Description of Operation

● CPU Unit Operation

The following describes the operation of synchronous input refreshing between an NX-series CPU Unit and the NX Units.

- All Digital Input Units and Analog Input Units that are connected to the CPU Units and operate with synchronous input refreshing read their inputs at the same time at a fixed interval based on the synchronization timing. (Refer to (a) in the figure below.)
- The Analog Input Units perform AD conversion once for each refresh cycle of the NX bus in order to obtain the AD converted values of all inputs for which the used channels are set to enable at the time to read inputs.
AD conversion is performed in order from the lowest channel number, so that the timing to convert is different for each input.
- The CPU Unit reads the input values, which are read by the Unit at the timing of reading inputs, at immediate I/O refreshing. (Refer to (b) in the figure below.)
- The interval of I/O refreshing varies with the processing conditions of the CPU Unit. (Refer to (c) in the figure below.) The timing to read inputs will be at a fixed interval. (Refer to (d) and (e) in the figure below.)
- The timing of reading inputs, the synchronization timing, and the maximum NX bus I/O refresh cycle are automatically calculated by the Sysmac Studio according to the input refresh cycles of the NX Units on the CPU Unit when a Unit configuration in the CPU Unit is created and set up.

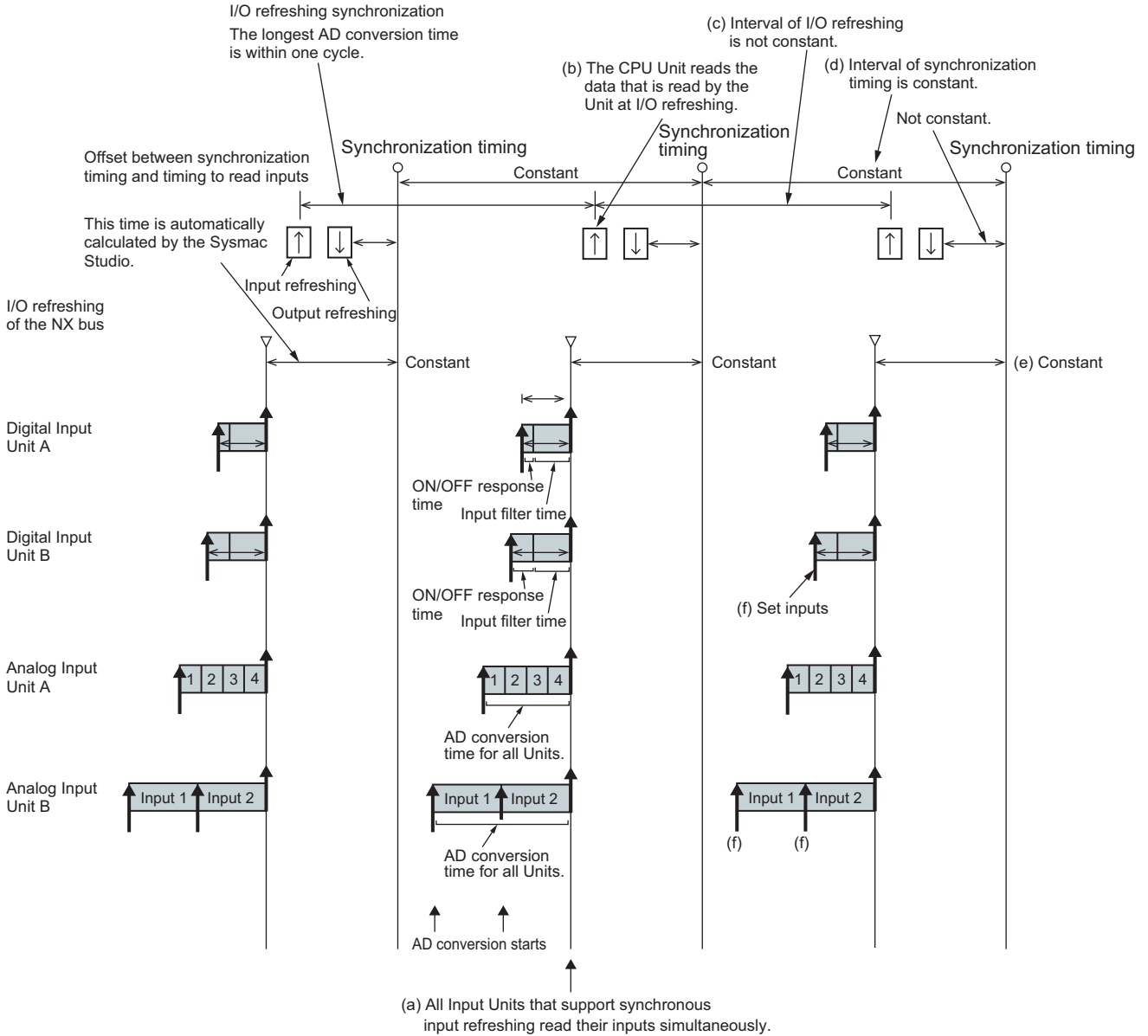

● Slave Terminal Operation

The following describes the operation of synchronous input refreshing of an EtherCAT Slave Terminal connected to the built-in EtherCAT port.

- All Digital Input Units and Analog Input Units that operate with synchronous input refreshing in the Slave Terminal read their inputs at the same time at a fixed interval based on Sync0. (Refer to (a) in the figure below.)^{*1}
 - The Analog Input Units perform AD conversion once for each refresh cycle of the NX bus in order to obtain the AD converted values of all inputs for which the used channels are set to enable at the time to read inputs.
AD conversion is performed in order from the lowest channel number, so that the timing to convert is different for each input.
 - The Communications Coupler Unit reads the input values, which are read by the Unit at the timing of reading inputs, at immediate I/O refreshing. (Refer to (b) in the figure below.)
 - The interval of I/O refreshing varies with the processing conditions of the Communications Coupler Unit or the host communications master. (Refer to (c) in the figure below.) The timing to read inputs will be at a fixed interval. (Refer to (d) and (e) in the figure below.)
 - The Sync0, the timing to read inputs and the maximum NX bus I/O refresh cycle of the Slave Terminals are automatically calculated by the Sysmac Studio according to the input refresh cycle of the NX Units in the Slave Terminals when the Slave Terminals are configured and set up.
- *1. If multiple Slave Terminals are present on the same EtherCAT network, refer to the *NX-series EtherCAT Coupler Unit User's Manual* (Cat. No. W519) for the range of available Slave Terminals that operate at the same timing.

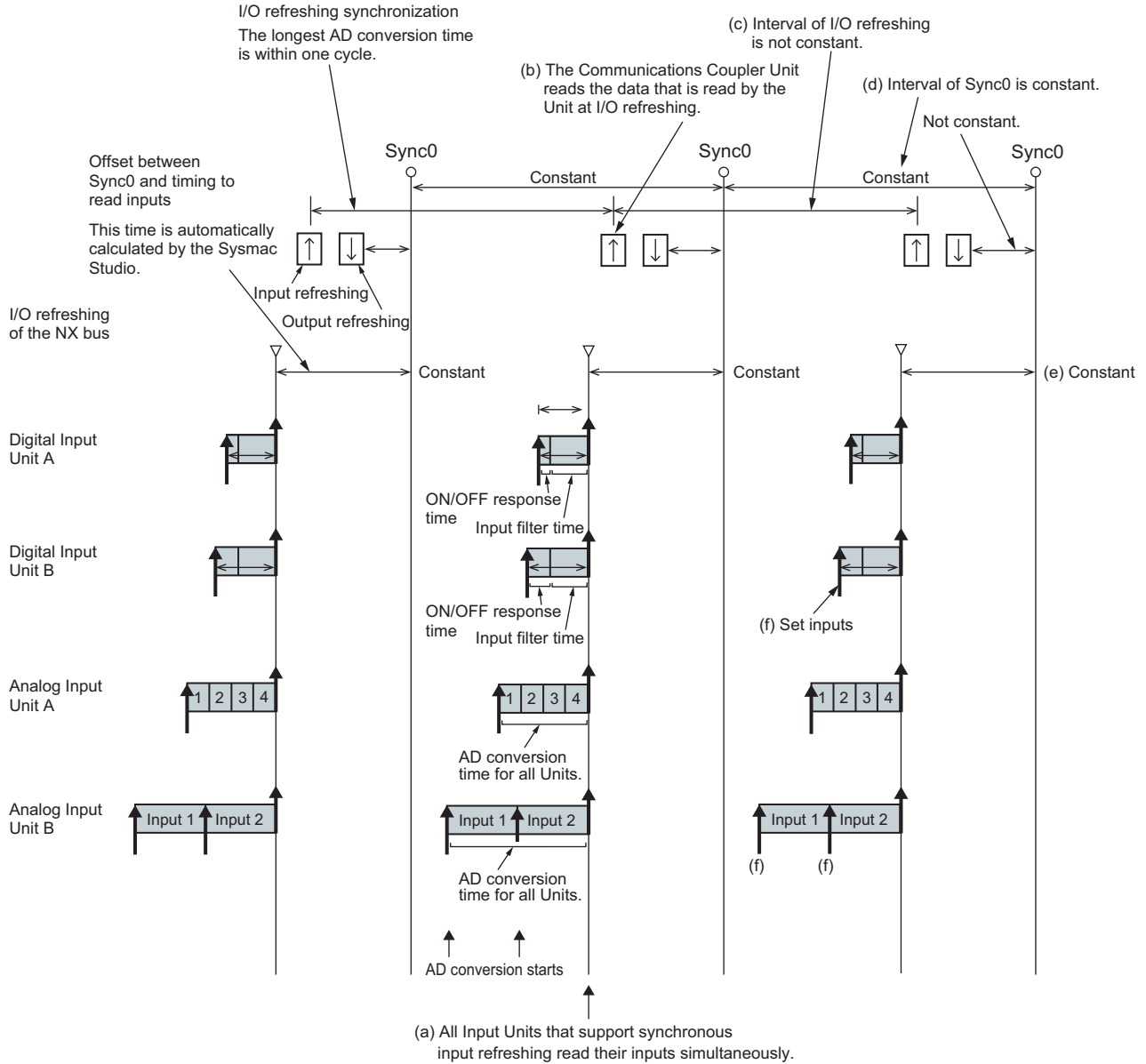

Settings

Add NX Units that support synchronous I/O refreshing to the CPU Unit configuration or Slave Terminal configuration.

After you add the NX Units, set an I/O refreshing method depending on the connected CPU Unit or Communications Coupler Unit so that these NX Units operate with synchronous I/O refreshing.

Refer to *5-2-2 Setting the I/O Refreshing Methods* on page 5-8 for the setting procedure of the I/O refreshing method.

5-2-6 Synchronous Output Refreshing

The I/O refreshing method described below. Among Slave Terminals, this refreshing method is supported only by EtherCAT Slave Terminals.

- The timing to refresh outputs is synchronized on a fixed interval between more than one NX Unit connected to a CPU Unit.
- The timing to refresh outputs is synchronized on a fixed interval between more than one NX Unit on more than one Slave Terminal.

This method is used when the problem such as input timing jitter or offset of timing to refresh outputs between more than one NX Unit happens.

This section explains operations when NX Units are connected to a CPU Unit or Communications Coupler Unit.

Refer to the user's manual for the Communication Control Unit for operations when NX Units are connected to a Communication Control Unit.

Description of Operation

● CPU Unit Operation

The following describes the operation of synchronous output refreshing between an NX-series CPU Unit and the NX Units.

- All Digital Output Units and Analog Output Units that are connected to the CPU Units and operate with synchronous output refreshing refresh their outputs at the same time at a fixed interval based on the synchronization timing. (Refer to (a) in the figure below.)
- The CPU Unit refreshes the output values at I/O refreshing. (Refer to (b) in the figure below.)
- The Analog Output Units perform DA conversion with the output set values that are refreshed once for each refresh cycle of the NX bus in order to output the DA converted values of all outputs for which the used channels are set to enable at the time to refresh outputs.
- The interval of I/O refreshing varies with the processing conditions of the CPU Unit. (Refer to (c) in the figure below.) The timing to refresh outputs will be at a fixed interval. (Refer to (d) and (e) in the figure below.)
- The timing of refreshing outputs, the synchronization timing, and the maximum NX bus I/O refresh cycle are automatically calculated by the Sysmac Studio according to the output refresh cycles of the NX Units on the CPU Unit when a Unit configuration in the CPU Unit is created and set up.
- The ON/OFF response time is needed from the timing to refresh outputs until setting the output status of external terminals on the NX Units. (Refer to (f) in the figure below.)

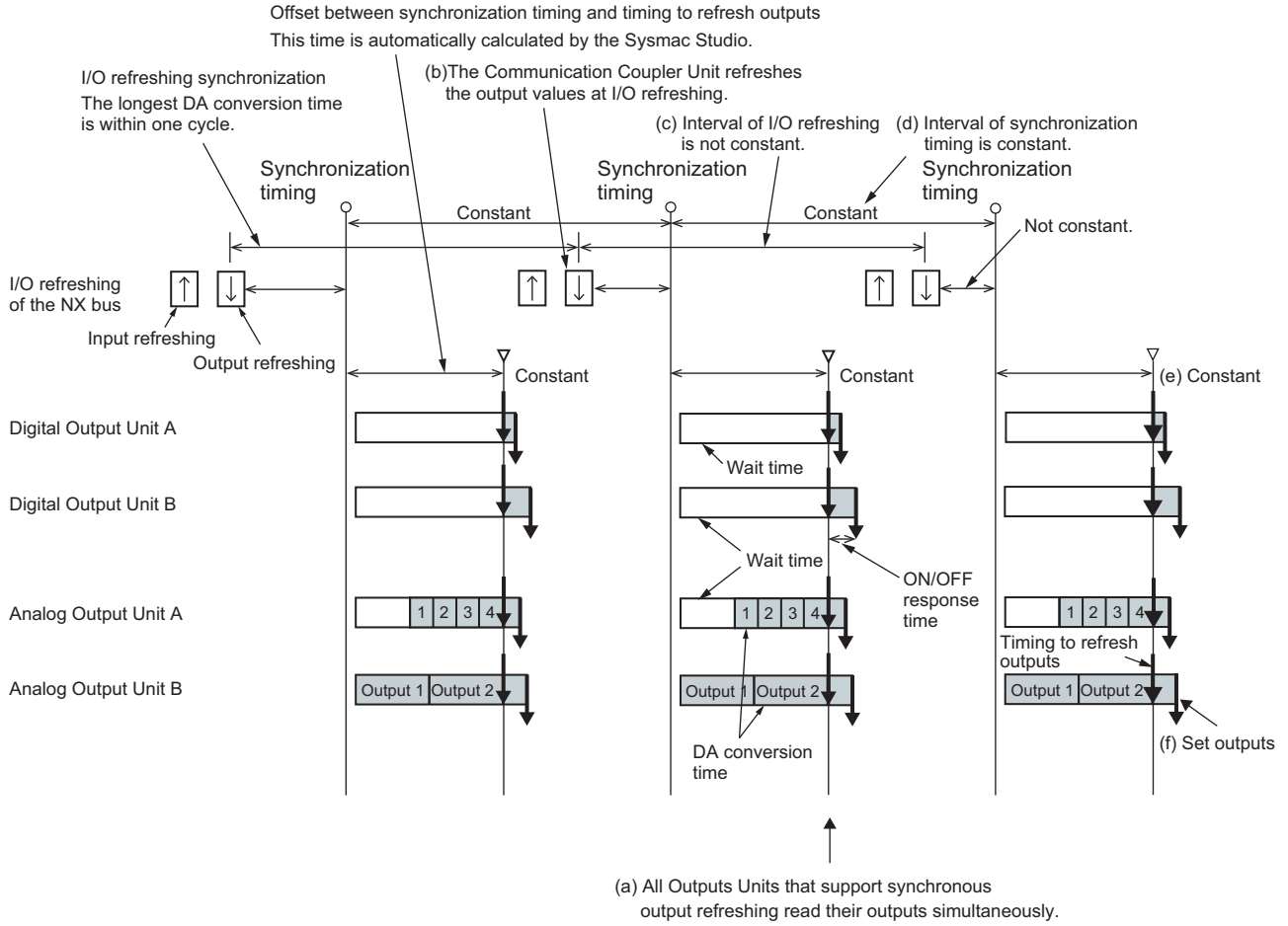

● Slave Terminal Operation

The following describes the operation of synchronous output refreshing of an EtherCAT Slave Terminal connected to the built-in EtherCAT port.

- All Digital Output Units and Analog Output Units that operate with synchronous output refreshing in the Slave Terminal refresh their outputs at the same time at a fixed interval based on Sync0. (Refer to (a) in the figure below.)*¹
- The Communication Coupler Unit refreshes the output values at I/O refreshing. (Refer to (b) in the figure below.)
- The Analog Output Units perform DA conversion with the output set values that are refreshed once for each refresh cycle of the NX bus in order to output the DA converted values of all outputs for which the used channels are set to enable at the time to refresh outputs.
- The interval of I/O refreshing varies with the processing conditions of the Communications Coupler Unit or the host communications master. (Refer to (c) in the figure below.) The timing to refresh outputs will be at a fixed interval. (Refer to (d) and (e) in the figure below.)
- The Sync0, the timing to refresh outputs and the maximum NX bus I/O refresh cycle of the Slave Terminals are automatically calculated by the Sysmac Studio according to the output refresh cycle of the NX Units in the Slave Terminals when the Slave Terminals are configured and set up.
- The ON/OFF response time is needed from the timing to refresh outputs until setting the output status of external terminals on the NX Units. (Refer to (f) in the figure below.)

*1. If multiple Slave Terminals are present on the same EtherCAT network, refer to the *NX-series EtherCAT Coupler Unit User's Manual* (Cat. No. W519) for the range of available Slave Terminals that operate at the same timing.

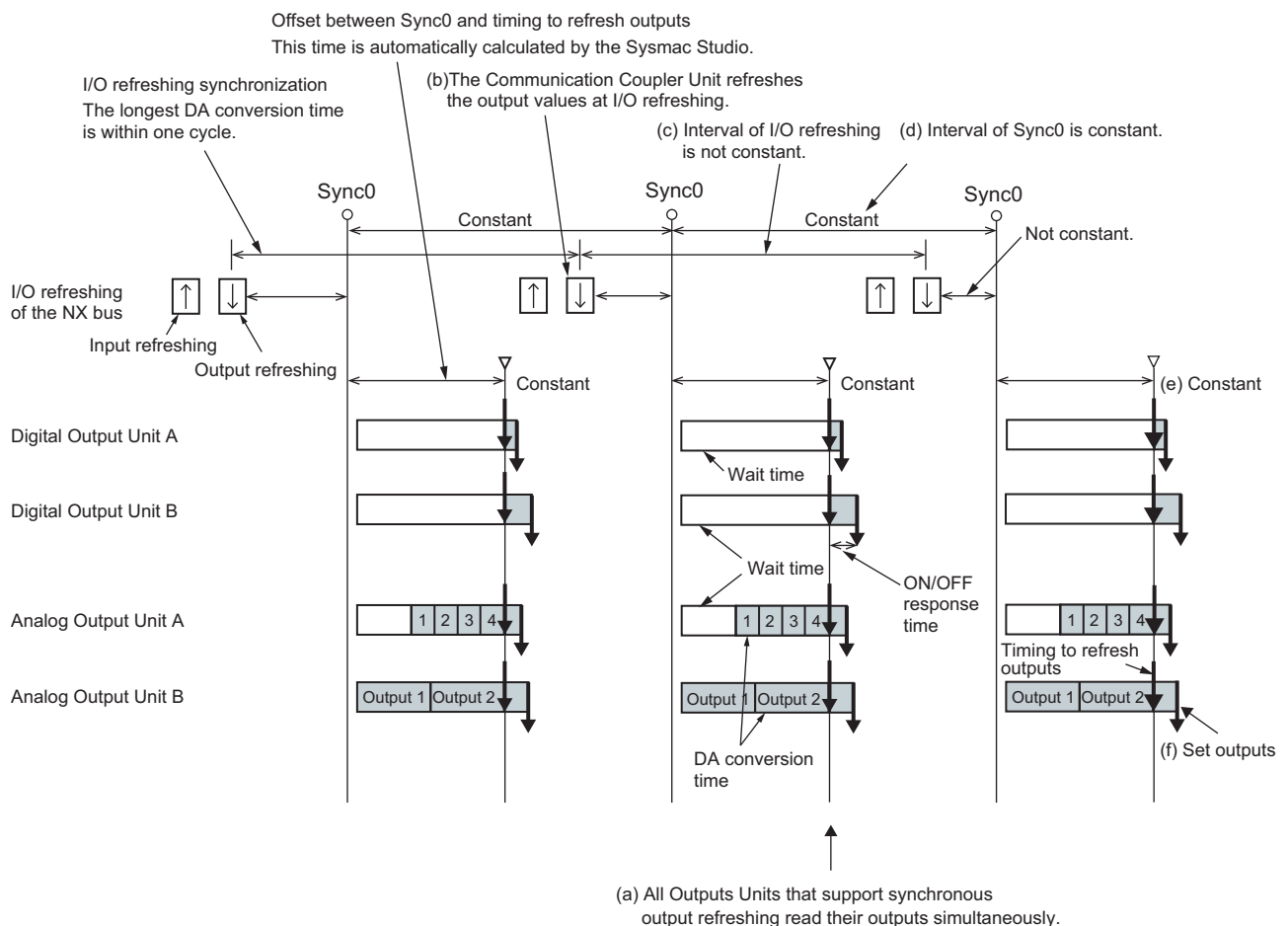

Settings

Same as the settings for synchronous input refreshing. Refer to *Settings* in *5-2-5 Synchronous Input Refreshing* on page 5-13 for details.

6

Analog Input Units

This section describes the types and functions of Analog Input Units.

6-1	Types of Analog Input Units	6-2
6-2	Input Range and Converted Values	6-4
6-3	Specifications of I/O Data	6-6
6-3-1	Allocable I/O Data	6-6
6-4	List of Settings	6-8
6-5	Function	6-12
6-5-1	List of Analog Input Unit Functions	6-12
6-5-2	Selecting Channel To Use	6-13
6-5-3	Moving Average	6-17
6-5-4	Input Disconnection Detection	6-23
6-5-5	Over Range/Under Range Detection	6-24
6-5-6	User Calibration	6-25

6-1 Types of Analog Input Units

Analog Input Units are the NX Units with functionality to convert analog input signals such as -10 to +10 V and 4 to 20 mA to digital values.

The Analog Input Unit types are described below.

Analog Input Units (Screwless Clamping Terminal Block, 12 mm Width)

Model	Number of points	Input range	Resolution	Input method	I/O refreshing method	Conversion time	Reference
NX-AD2203	2 points	4 to 20 mA	1/8000	Single-ended	Free-Run refreshing	250 µs/point	P. A-5
NX-AD2204							P. A-7
NX-AD2208			1/30000	Differential	Switching Synchronous I/O refreshing and Free-Run refreshing	10 µs/point	P. A-8
NX-AD2603		-10 to +10 V	1/8000	Single-ended	Free-Run refreshing	250 µs/point	P. A-9
NX-AD2604							P. A-10
NX-AD2608			1/30000	Differential	Switching Synchronous I/O refreshing and Free-Run refreshing	10 µs/point	P. A-11
NX-AD3203	4 points	4 to 20 mA	1/8000	Single-ended	Free-Run refreshing	250 µs/point	P. A-12
NX-AD3204							P. A-13
NX-AD3208			1/30000	Differential	Switching Synchronous I/O refreshing and Free-Run refreshing	10 µs/point	P. A-14
NX-AD3603		-10 to +10 V	1/8000	Single-ended	Free-Run refreshing	250 µs/point	P. A-15
NX-AD3604							P. A-16
NX-AD3608			1/30000	Differential	Switching Synchronous I/O refreshing and Free-Run refreshing	10 µs/point	P. A-17

Model	Number of points	Input range	Resolution	Input method	I/O refreshing method	Conversion time	Reference
NX-AD4203	8 points	4 to 20 mA	1/8000	Single-ended	Free-Run refreshing	250 μ s/point	P. A-18
NX-AD4204							P. A-19
NX-AD4208			1/30000	Differential	Switching Synchronous I/O refreshing and Free-Run refreshing	10 μ s/point	P. A-20
NX-AD4603		-10 to +10 V	1/8000	Single-ended	Free-Run refreshing	250 μ s/point	P. A-21
NX-AD4604							
NX-AD4608					1/30000	Differential	Switching Synchronous I/O refreshing and Free-Run refreshing

6-2 Input Range and Converted Values

Input analog signals are converted to digital values according to the input range shown below.

If the input range exceeds the value range for which conversion is possible, the converted value is fixed at the upper or lower limit.

Input Range: -10 to +10 V

● 1/8000 Resolution

A voltage of -10 to +10 V is converted to a signed integer value (-4000 to +4000).

The input voltage range for which conversion is possible is -11 to +11 V and here the converted value is a signed integer value (-4400 to +4400).

There is no disconnection detection function.

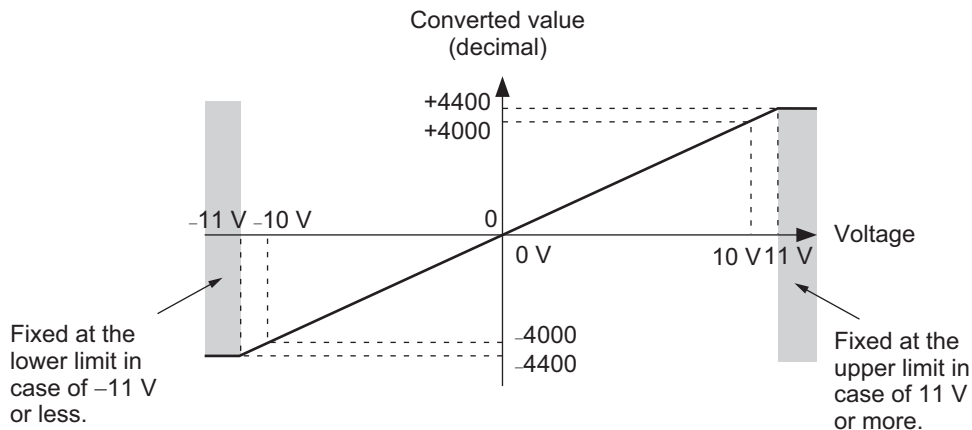

● 1/30000 Resolution

A voltage of -10 to +10 V is converted to a signed integer value (-15000 to +15000).

The input voltage range for which conversion is possible is -11 to +11 V and here the converted value is a signed integer value (-16500 to +16500).

There is no disconnection detection function.

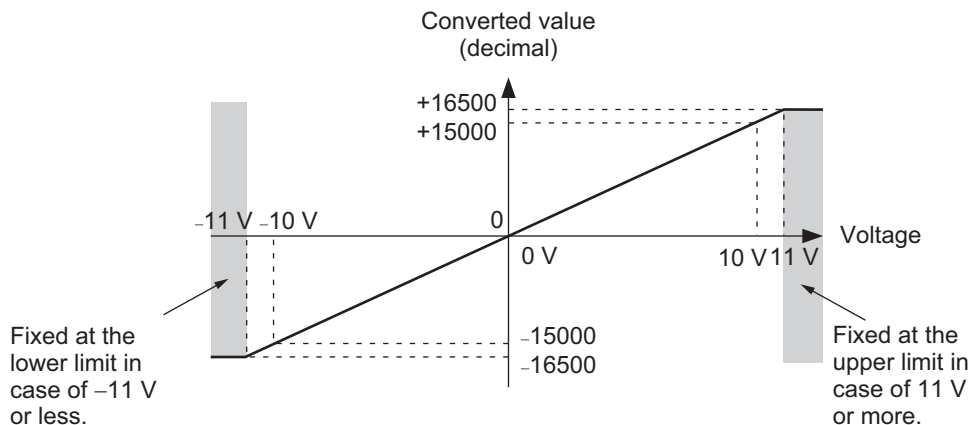

Input Range: 4 to 20 mA

● 1/8000 Resolution

A current of 4 to 20 mA is converted to a signed integer value (0 to 8000).

The input current range for which conversion is possible is 3.2 to 20.8 mA and here the converted value is a signed integer value (-400 to +8400).

If the input value falls below the input range such as for a disconnection, and the input current is less than 1.2 mA, the disconnection detection function activates and the converted value is 32767.

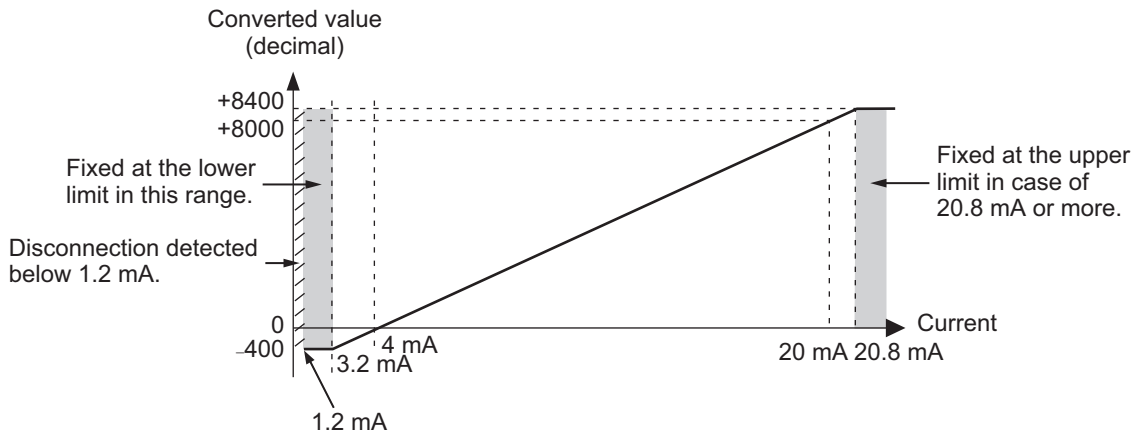

● 1/30000 Resolution

A current of 4 to 20 mA is converted to a signed integer value (0 to 30000).

The input current range for which conversion is possible is 3.2 to 20.8 mA and here the converted value is a signed integer value (-1500 to +31500).

If the input value falls below the input range such as for a disconnection, and the input current is less than 1.2 mA, the disconnection detection function activates and the converted value is 32767.

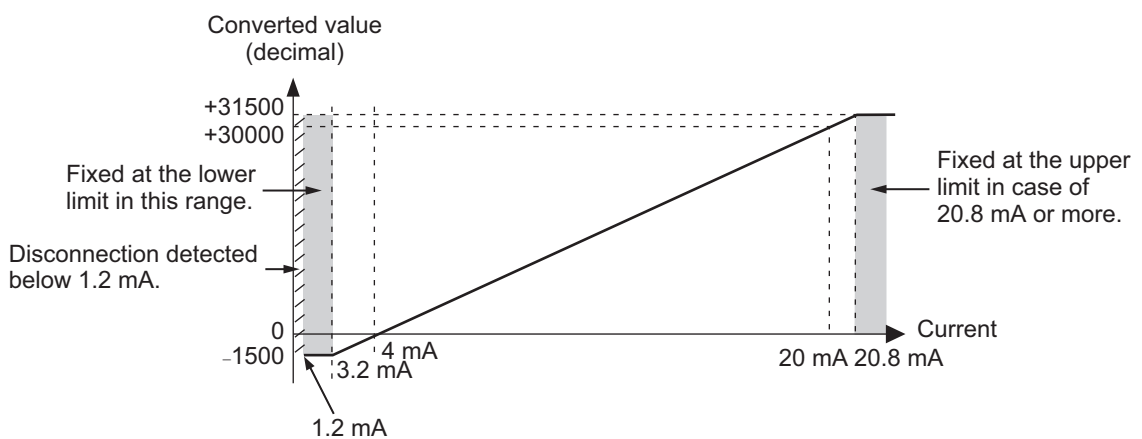

6-3 Specifications of I/O Data

This section describes the I/O data for the Analog Input Units.

6-3-1 Allocable I/O Data

This section describes the allocable I/O data in the Analog Input Unit.

An I/O entry mapping is assigned to the I/O allocation settings for the Analog Input Unit.

A specific I/O entry is assigned to the I/O entry mapping for each NX Unit model. These allocations are fixed, so you cannot add others or change them.

An I/O entry means the I/O data described in this section. An I/O entry mapping means a collection of I/O entries.

To assign the I/O allocation information of the NX Unit or Slave Terminal to an NJ/NX-series CPU Unit or NY-series Industrial PC, use the I/O ports for the allocated I/O data.

However, for Slave Terminals, I/O ports may not be used depending on the type of communications master or Communications Coupler Unit.

Refer to the user's manual for the connected Communications Coupler Unit for details on how to use I/O data for Slave Terminals.

Refer to the user's manual for the Communication Control Unit for details on how to use I/O data for Communication Control Units.

● Two-point Input Units

Data name	Description	Data type	Default value	I/O port name	Index	Sub-index
Ch1 Analog Input Value	Value of analog input 1	INT	0	Ch1 Analog Input Value	6000 hex	01 hex
Ch2 Analog Input Value	Value of analog input 2	INT	0	Ch2 Analog Input Value		02 hex

● Four-point Input Units

Data name	Description	Data type	Default value	I/O port name	Index	Sub-index
Ch1 Analog Input Value	Value of analog input 1	INT	0	Ch1 Analog Input Value	6000 hex	01 hex
Ch2 Analog Input Value	Value of analog input 2	INT	0	Ch2 Analog Input Value		02 hex
Ch3 Analog Input Value	Value of analog input 3	INT	0	Ch3 Analog Input Value		03 hex
Ch4 Analog Input Value	Value of analog input 4	INT	0	Ch4 Analog Input Value		04 hex

● Eight-point Input Units

Data name	Description	Data type	Default value	I/O port name	Index	Subindex
Ch1 Analog Input Value	Value of analog input 1	INT	0	Ch1 Analog Input Value	6000 hex	01 hex
Ch2 Analog Input Value	Value of analog input 2	INT	0	Ch2 Analog Input Value		02 hex
Ch3 Analog Input Value	Value of analog input 3	INT	0	Ch3 Analog Input Value		03 hex
Ch4 Analog Input Value	Value of analog input 4	INT	0	Ch4 Analog Input Value		04 hex
Ch5 Analog Input Value	Value of analog input 5	INT	0	Ch5 Analog Input Value		05 hex
Ch6 Analog Input Value	Value of analog input 6	INT	0	Ch6 Analog Input Value		06 hex
Ch7 Analog Input Value	Value of analog input 7	INT	0	Ch7 Analog Input Value		07 hex
Ch8 Analog Input Value	Value of analog input 8	INT	0	Ch8 Analog Input Value		08 hex

6-4 List of Settings

The followings are the setting descriptions, setting ranges, and default values of the functions that can be used in the Analog Input Units.

The settings are reflected after the Unit is restarted.



Precautions for Safe Use

The Unit is required to restart after the transfer of Unit operation settings on the Support Software is completed. Always sufficiently check the safety at the connected devices before you transfer the Unit operation settings.



Precautions for Correct Use

Set the Ch□ Enable/Disable parameter to *Enable* for at least one channel for a Unit.

If you disabled all channels for a Unit, an NX Unit Initialization Error event (event code: 84C10000 hex) occurs.

● Two-point Input Units

Setting name	Description	Default value	Setting range	Unit	Index	Sub-index	Reference
Ch1 Enable/Disable	Set to enable or disable the channel.	TRUE	TRUE or FALSE	---	5002 hex	01 hex	P. 6-13
Ch2 Enable/Disable	FALSE: Disable TRUE: Enable	TRUE	TRUE or FALSE	---		02 hex	
Ch1 Range Setting	Set the range.	*1	*1	---	5003 hex	01 hex	P. 6-4
Ch2 Range Setting	0: 4 to 20 mA 1: 0 to 10 V 2: -10 to +10 V 3: 0 to 5 V 4: 1 to 5 V 5: 0 to 20 mA	*1	*1	---		02 hex	
Ch1 Input Moving Average Time	Set the time to process moving average.	0	*2	μs	5004 hex	01 hex	P. 6-17
Ch2 Input Moving Average Time		0	*2	μs		02 hex	

*1. The default value and setting range of Ch□ Range Setting depend on the model. The default value and setting range for each NX Unit are as follows.

NX Units	Default value	Setting range
NX-AD2203/AD2204/AD2208	0	0
NX-AD2603/AD2604/AD2608	2	2

- *2. The setting range of Ch□ Input Moving Average Time depends on the model. The setting range for each model is as follows.

NX Units	Setting range
NX-AD2203/AD2204/AD2603/AD2604	0 to 32000
NX-AD2208/AD2608	0 to 640

● Four-point Input Units

Setting name	Description	Default value	Setting range	Unit	Index	Subindex	Reference
Ch1 Enable/Disable	Set to enable or disable the channel. FALSE: Disable TRUE: Enable	TRUE	TRUE or FALSE	---	5002 hex	01 hex	P. 6-13
Ch2 Enable/Disable		TRUE	TRUE or FALSE	---		02 hex	
Ch3 Enable/Disable		TRUE	TRUE or FALSE	---		03 hex	
Ch4 Enable/Disable		TRUE	TRUE or FALSE	---		04 hex	
Ch1 Range Setting	Set the range. 0: 4 to 20 mA 1: 0 to 10 V 2: -10 to +10 V 3: 0 to 5 V 4: 1 to 5 V 5: 0 to 20 mA	*1	*1	---	5003 hex	01 hex	P. 6-4
Ch2 Range Setting		*1	*1	---		02 hex	
Ch3 Range Setting		*1	*1	---		03 hex	
Ch4 Range Setting		*1	*1	---		04 hex	
Ch1 Input Moving Average Time	Set the time to process moving average.	0	*2	μs	5004 hex	01 hex	P. 6-17
Ch2 Input Moving Average Time		0	*2	μs		02 hex	
Ch3 Input Moving Average Time		0	*2	μs		03 hex	
Ch4 Input Moving Average Time		0	*2	μs		04 hex	

- *1. The default value and setting range of Ch□ Range Setting depend on the model. The default value and setting range for each NX Unit are as follows.

NX Units	Default value	Setting range
NX-AD3203/AD3204/AD3208	0	0
NX-AD3603/AD3604/AD3608	2	2

- *2. The setting range of Ch□ Input Moving Average Time depends on the model. The setting range for each model is as follows.

NX Units	Setting range
NX-AD3203/AD3204/AD3603/AD3604	0 to 32000
NX-AD3208/3608	0 to 640

● Eight-point Input Units

Setting name	Description	Default value	Setting range	Unit	Index	Sub-index	Reference
Ch1 Enable/Disable	Set to enable or disable the channel. FALSE: Disable TRUE: Enable	TRUE	TRUE or FALSE	---	5002 hex	01 hex	P. 6-13
Ch2 Enable/Disable		TRUE	TRUE or FALSE	---		02 hex	
Ch3 Enable/Disable		TRUE	TRUE or FALSE	---		03 hex	
Ch4 Enable/Disable		TRUE	TRUE or FALSE	---		04 hex	
Ch5 Enable/Disable		TRUE	TRUE or FALSE	---		05 hex	
Ch6 Enable/Disable		TRUE	TRUE or FALSE	---		06 hex	
Ch7 Enable/Disable		TRUE	TRUE or FALSE	---		07 hex	
Ch8 Enable/Disable		TRUE	TRUE or FALSE	---		08 hex	
Ch1 Range Setting	Set the range. 0: 4 to 20 mA 1: 0 to 10 V 2: -10 to +10 V 3: 0 to 5 V 4: 1 to 5 V 5: 0 to 20 mA	*1	*1	---	5003 hex	01 hex	P. 6-4
Ch2 Range Setting		*1	*1	---		02 hex	
Ch3 Range Setting		*1	*1	---		03 hex	
Ch4 Range Setting		*1	*1	---		04 hex	
Ch5 Range Setting		*1	*1	---		05 hex	
Ch6 Range Setting		*1	*1	---		06 hex	
Ch7 Range Setting		*1	*1	---		07 hex	
Ch8 Range Setting		*1	*1	---		08 hex	
Ch1 Input Moving Average Time	Set the time to process moving average.	0	*2	μs	5004 hex	01 hex	P. 6-17
Ch2 Input Moving Average Time		0	*2	μs		02 hex	
Ch3 Input Moving Average Time		0	*2	μs		03 hex	
Ch4 Input Moving Average Time		0	*2	μs		04 hex	
Ch5 Input Moving Average Time		0	*2	μs		05 hex	
Ch6 Input Moving Average Time		0	*2	μs		06 hex	
Ch7 Input Moving Average Time		0	*2	μs		07 hex	
Ch8 Input Moving Average Time		0	*2	μs		08 hex	

*1. The default value and setting range of Ch□ Range Setting depend on the model. The default value and setting range for each NX Unit are as follows.

NX Units	Default value	Setting range
NX-AD4203/AD4204/AD4208	0	0
NX-AD4603/AD4604/AD4608	2	2

- *2. The setting range of Ch□ Input Moving Average Time depends on the model. The setting range for each model is as follows.

NX Units	Setting range
NX-AD4203/AD4204/AD4603/AD4604	0 to 32000
NX-AD4208/4608	0 to 640

6-5 Function

This section describes the Analog Input Unit functions.

Refer to the specifications of each model in *A-1 Data Sheet* on page A-2 for details on the functions.

6-5-1 List of Analog Input Unit Functions

Function name	Description	Reference
Free-Run Refreshing	With this I/O refreshing method, the refresh cycle of the NX bus and the I/O refresh cycles of the NX Units are asynchronous.	5-2-4 <i>Free-Run Refreshing</i> on page 5-9
Synchronous I/O Refreshing	With this I/O refreshing method, the timing to read inputs or to refresh outputs is synchronized on a fixed interval between more than one NX Unit connected to a CPU Unit. In addition, with this I/O refreshing method, the timing to read inputs or to refresh outputs is synchronized on a fixed interval between more than one NX Unit on more than one Slave Terminal.	5-2-5 <i>Synchronous Input Refreshing</i> on page 5-13
Selecting Channel To Use	This function omits the conversion processing for unused inputs. It is used to reduce the conversion cycle for its own Unit.	6-5-2 <i>Selecting Channel To Use</i> on page 6-13
Moving Average	This function uses the average value of inputs of the set time as the converted value. When the input value fluctuates frequently due to noises, averaging can be used to obtain a stable converted value. This function can be used only for Free-Run refreshing.	6-5-3 <i>Moving Average</i> on page 6-17
Input Disconnection Detection	This function detects disconnections of the analog input signal lines. It can be used only for models with an input range of 4 to 20 mA.	6-5-4 <i>Input Disconnection Detection</i> on page 6-23
Over Range/Under Range Detection	This function detects when the input signal exceeds the range for which conversion is possible.	6-5-5 <i>Over Range/Under Range Detection</i> on page 6-24
User Calibration	This function corrects offsets in the converted values that occur due to the deterioration of the NX Units and calibrate the Units.	6-5-6 <i>User Calibration</i> on page 6-25

6-5-2 Selecting Channel To Use

Purpose

This function skips the conversion processing and error detection processing for unused inputs, and shortens the conversion time.

Details on the Function

Normally in this Unit, the input signals for the number of input points are converted in sequence. The setting can be changed, so that unused inputs are not converted.

By reducing the number of conversion points, the conversion time is shortened.

Whether the channel is enabled or disabled is settable for each input.

However, set the Ch□ Enable/Disable parameter to *Enable* for at least one channel for a Unit.

If you disabled all channels for a Unit, an NX Unit Initialization Error event (event code: 84C10000 hex) occurs.

Refer to the user's manual for the Communications Coupler Unit for details on events.

● Two-point Input Units

Setting name	Description	Default value	Unit
Ch1 Enable/Disable	Set to enable or disable the channel.	TRUE	---
Ch2 Enable/Disable		TRUE	---
	FALSE: Disable TRUE: Enable		

● Four-point Input Units

Setting name	Description	Default value	Unit
Ch1 Enable/Disable	Set to enable or disable the channel.	TRUE	---
Ch2 Enable/Disable		TRUE	---
Ch3 Enable/Disable		TRUE	---
Ch4 Enable/Disable		TRUE	---
	FALSE: Disable TRUE: Enable		

● Eight-point Input Units

Setting name	Description	Default value	Unit
Ch1 Enable/Disable	Set to enable or disable the channel.	TRUE	---
Ch2 Enable/Disable		TRUE	---
Ch3 Enable/Disable		TRUE	---
Ch4 Enable/Disable		TRUE	---
Ch5 Enable/Disable		TRUE	---
Ch6 Enable/Disable		TRUE	---
Ch7 Enable/Disable		TRUE	---
Ch8 Enable/Disable		TRUE	---

Target NX Units

All Analog Input Units

Setting Method

This section describes how to configure settings with the Sysmac Studio.

When you are using Support Software other than the Sysmac Studio, in the Edit Unit Operation Settings Tab Page, set the parameters described in the procedure and transfer the settings to the target NX Unit.

For details on how to display the Edit Unit Operation Settings Tab Page and to transfer settings to an NX Unit with Support Software other than the Sysmac Studio, refer to the operation manual for the Support Software that you are using.

- 1 Display the Edit Unit Operation Settings Tab Page.
For the display methods, refer to *A-8 Displaying the Edit Unit Operation Settings Tab Page* on page A-63.
- 2 Select *True* (Enable) or *False* (Disable) from the list of Input Enable/Disable Setting for which the channel you want to set.

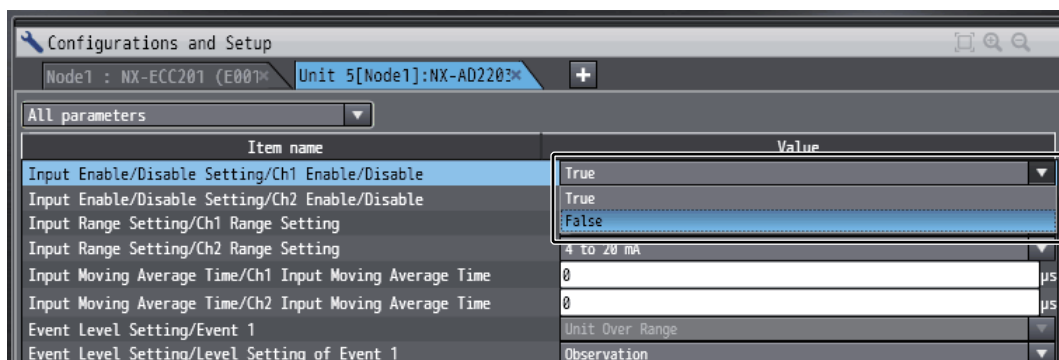



Additional Information

- Click a list button on the tab page to display the item in the Edit Unit Operation Settings Tab Page.

Example:

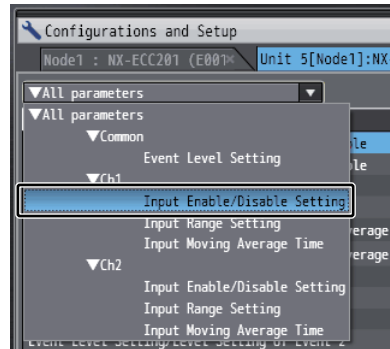

Select Input Enable/Disable Setting under Ch1

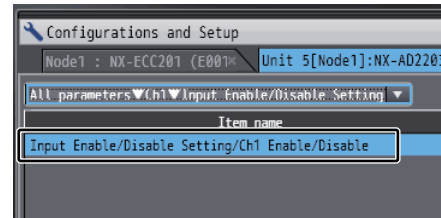

Only Input Enable/Disable Setting under Ch1 is displayed

- If you set a value different from the default value, the Value on the Sysmac Studio is displayed in a different color.
- You can click the **Return to Default Value** Button to return all set values on the Sysmac Studio to the default values.
- Help for the settings is displayed at the bottom of the Edit Unit Operation Settings Tab Page.

3 Click the **Transfer to Unit** Button.

The settings are transferred from the Sysmac Studio to the NX Unit.

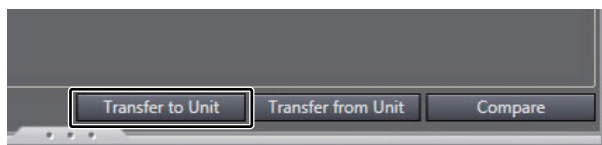

The settings are reflected after the Unit is restarted.



Precautions for Safe Use

The Unit is required to restart after the transfer of Unit operation settings on the Support Software is completed. Always sufficiently check the safety at the connected devices before you transfer the Unit operation settings.

Calculating Conversion Time

The conversion time per unit according to the number of available conversion channels is as follows.

Number of available conversion channels	Conversion time per unit (μs)	
	Conversion time: 250 $\mu\text{s}/\text{point}$	Conversion time: 10 $\mu\text{s}/\text{point}$
1 channel	250	10
2 channels	500	20
3 channels	750	30
4 channels	1000	40
5 channels	1250	50
6 channels	1500	60
7 channels	1750	70
8 channels	2000	80

6-5-3 Moving Average

Purpose

This function averages the inputs if they fluctuate minutely due to noise and so on as shown in the figure below, and obtains smooth input values.

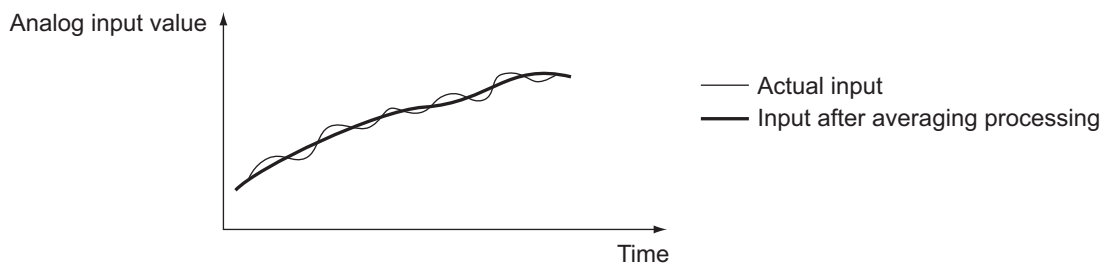

Details on the Function

For the inputs for which the used channels are set to enable, the average value (moving average) of analog inputs is calculated for a maximum of 32000 μs (conversion time: 250 μs / point) or 640 μs (conversion time: 10 μs /point) and it is used as the converted value.

However, if the Analog Input Unit is set to operate with synchronous I/O refreshing, the moving average function does not operate regardless of the set value of the input moving average time.

The processing contents in the Unit are shown below as an example, in which an NX Unit with a conversion time of 250 μs /point is used, 4 points are enabled and the input moving average time is set to 4000 μs .

At the initial calculation, the initial data is stored in all moving average buffers to perform the moving average processing.

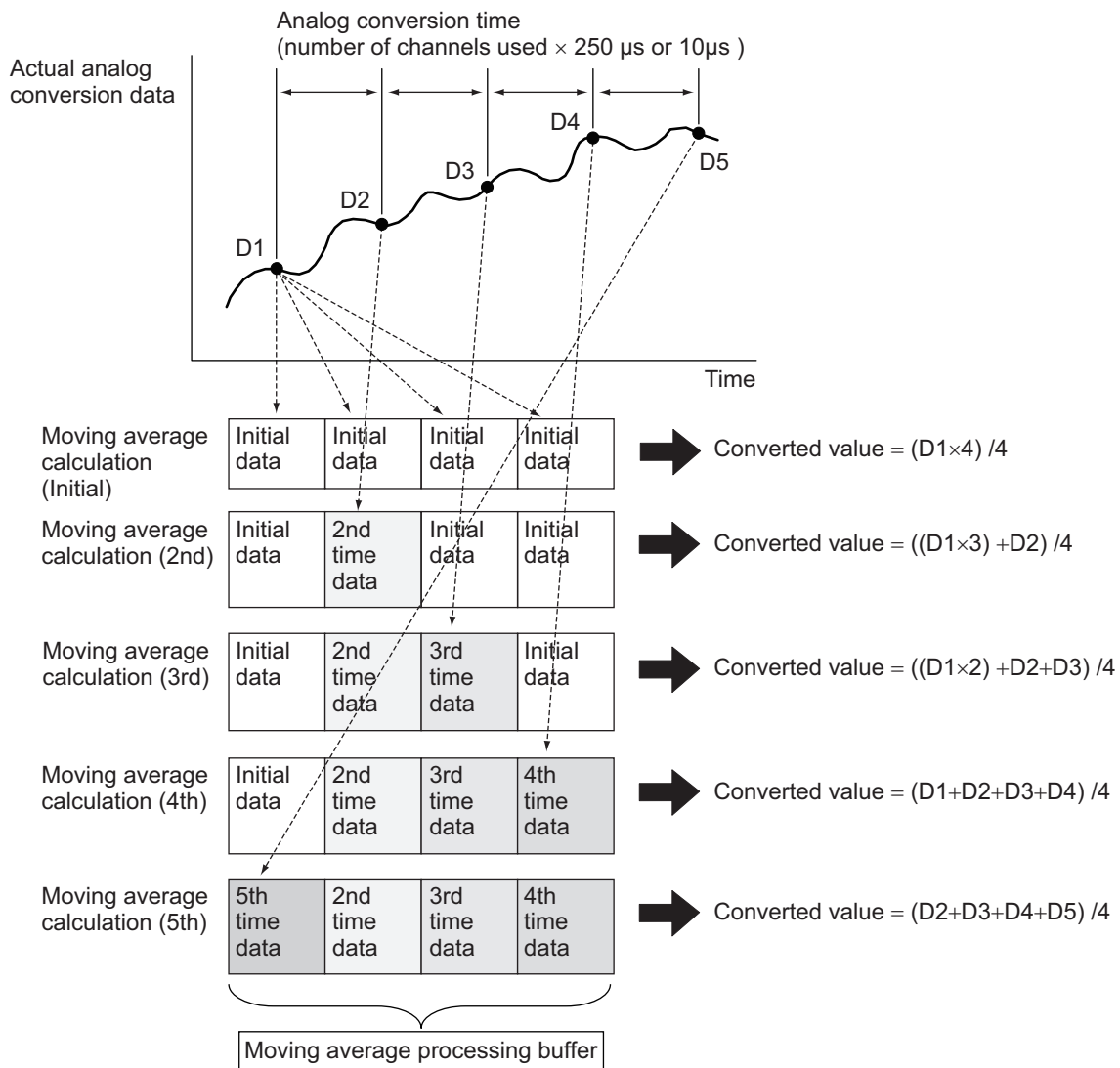

The settings are made by the "input moving average time (μs)".

The input moving average time can be set for each input.

The input moving average time is:

The number of data items for which the moving average is processed x analog conversion time (number of channels used x 250 μs)

Note that if 0 is set, the moving average processing is not performed.

[Setting example of input moving average time]

When the number of channels used is to be set to 4 and the number of sampling data items to 4:

Input moving average time = 4 x (4 x 250 μs) = 4000 μs (set value: 4000)

● Two-point Input Units

Setting name	Description	Default value	Setting range	Unit
Ch1 Input Moving Average Time	Set the time to process moving average.	0	*1	μs
Ch2 Input Moving Average Time		0	*1	μs

*1. The setting range of Ch□ Input Moving Average Time depends on the model. The setting range for each model is as follows.

NX Units	Setting range
NX-AD2203/AD2204/AD2603/AD2604	0 to 32000
NX-AD2208/AD2608	0 to 640

● Four-point Input Units

Setting name	Description	Default value	Setting range	Unit
Ch1 Input Moving Average Time	Set the time to process moving average.	0	*1	μs
Ch2 Input Moving Average Time		0	*1	μs
Ch3 Input Moving Average Time		0	*1	μs
Ch4 Input Moving Average Time		0	*1	μs

*1. The setting range of Ch□ Input Moving Average Time depends on the model. The setting range for each model is as follows.

NX Units	Setting range
NX-AD3203/AD3204/AD3603/AD3604	0 to 32000
NX-AD3208/AD3608	0 to 640

● Eight-point Input Units

Setting name	Description	Default value	Setting range	Unit
Ch1 Input Moving Average Time	Set the time to process moving average.	0	*1	μs
Ch2 Input Moving Average Time		0	*1	μs
Ch3 Input Moving Average Time		0	*1	μs
Ch4 Input Moving Average Time		0	*1	μs
Ch5 Input Moving Average Time		0	*1	μs
Ch6 Input Moving Average Time		0	*1	μs
Ch7 Input Moving Average Time		0	*1	μs
Ch8 Input Moving Average Time		0	*1	μs

*1. The setting range of Ch□ Input Moving Average Time depends on the model. The setting range for each model is as follows.

NX Units	Setting range
NX-AD4203/AD4204/AD4603/AD4604	0 to 32000
NX-AD4208/AD4608	0 to 640

Target NX Units

All Analog Input Units

Setting Method

This section describes how to configure settings with the Sysmac Studio.

When you are using Support Software other than the Sysmac Studio, in the Edit Unit Operation Settings Tab Page, set the parameters described in the procedure and transfer the settings to the target NX Unit.

For details on how to display the Edit Unit Operation Settings Tab Page and to transfer settings to an NX Unit with Support Software other than the Sysmac Studio, refer to the operation manual for the Support Software that you are using.

- 1 Display the Edit Unit Operation Settings Tab Page.
For the display methods, refer to *A-8 Displaying the Edit Unit Operation Settings Tab Page* on page A-63.
- 2 Enter the time to process moving average (0 to 32000 or 0 to 640 μ s) in the text box of Input Moving Average Time for the channel you want to set.

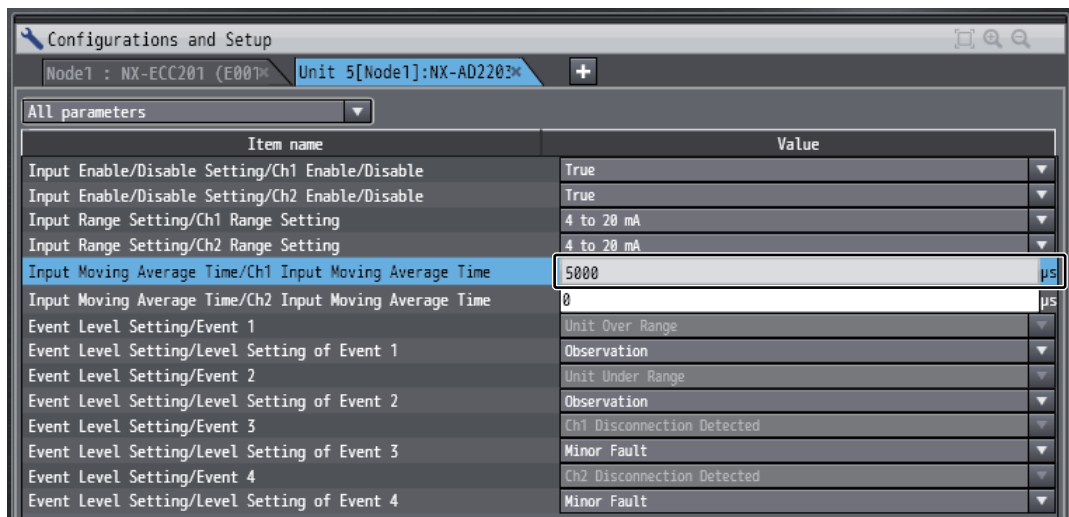



Additional Information

- Click a list button on the tab page to display the item in the Edit Unit Operation Settings Tab Page.

Example:

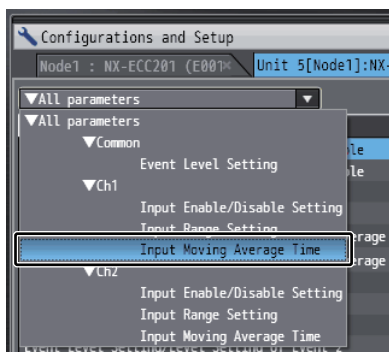

Select Input Moving Average Time under Ch1

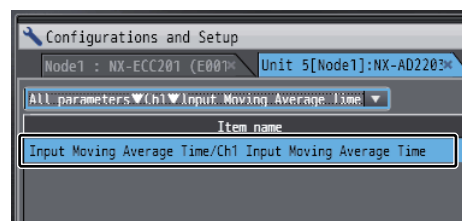

Only Input Moving Average Time under Ch1 is displayed

- If you set a value different from the default value, the Value on the Sysmac Studio is displayed in a different color.
- You can click the **Return to Default Value** Button to return all set values on the Sysmac Studio to the default values.
- Help for the settings is displayed at the bottom of the Edit Unit Operation Settings Tab Page.

3 Click the **Transfer to Unit** Button.

The settings are transferred from the Sysmac Studio to the NX Unit.

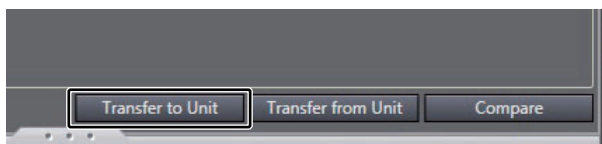

The settings are reflected after the Unit is restarted.



Precautions for Safe Use

The Unit is required to restart after the transfer of Unit operation settings on the Support Software is completed. Always sufficiently check the safety at the connected devices before you transfer the Unit operation settings.

6-5-4 Input Disconnection Detection

Purpose

This function detects disconnections of the analog input signal lines. However, it is only available when the input range is 4 to 20 mA.

Details on the Function

- If any analog input signal line (current inputs) of the inputs that are enabled by the selecting channel to use function is disconnected, or the input current is less than 1.2 mA, the converted value is 32767. At this time, the Disconnection Detection Status turns ON and a Unit I/O Disconnection Detected for Channel□ event (event code: 65030000 hex to 65A00000 hex) occurs.
- If the input returns to the conversion range again, the value becomes the normal converted value. When the cause of the error is removed and the error is reset, the Disconnection Detection Status turns OFF.
- Refer to *A-3 List of NX Objects* on page A-39 for details on status and *8-3-3 Event Codes and Corrections for Errors* on page 8-7 for details on events.

Target NX Units

Analog Input Units with the input range of 4 to 20 mA

Setting Method

No setting is required.

6-5-5 Over Range/Under Range Detection

Purpose

This function detects when the input signal exceeds the range for which conversion is possible.

Details on the Function

- If the input signal exceeds the upper limit of the conversion range, the converted value is fixed at the upper limit. At this time, the Over Range Status turns ON and a Unit Over Range for Channel□ event (event code: 64F00000 to 64F70000 hex) occurs.
- If the input signal falls below the lower limit of the conversion range, the converted value is fixed at the lower limit. At this time, the Under Range Status turns ON and a Unit Under Range for Channel□ event (event code: 64F80000 to 64FF0000 hex) occurs.
- When the input signal returns to the conversion range, the fixing is cancelled and the value becomes the normal converted value. When the cause of the error is removed and the error is reset, the Over Range/Under Range Status turns OFF.
- Refer to *A-3 List of NX Objects* on page A-39 for details on status and *8-3-3 Event Codes and Corrections for Errors* on page 8-7 for details on events.

Target NX Units

All Analog Input Units

Setting Method

No setting is required.

6-5-6 User Calibration

Purpose

This function corrects offsets in the converted values that occur due to the deterioration of the NX Units and calibrate the Units again.

You can use this function to calibrate the equipment that requires the periodic calibration.

Details on the Function

This function corrects the converted values of input voltages and input currents at 2 points, 0% and 100%, as shown in the figure below.

The calibration result is saved in the NX Unit.

● Calibration Example 1

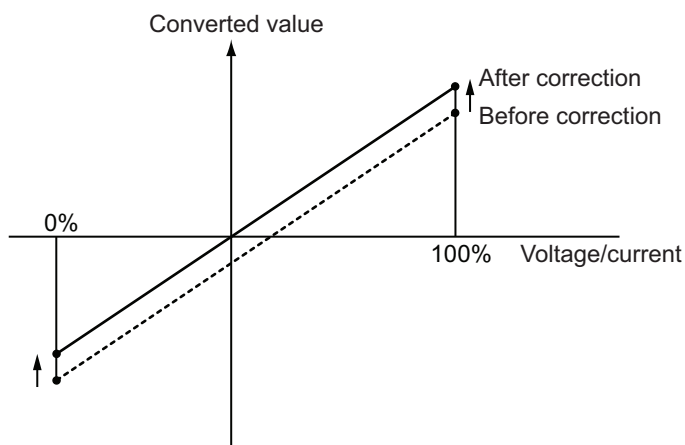

● Calibration Example 2

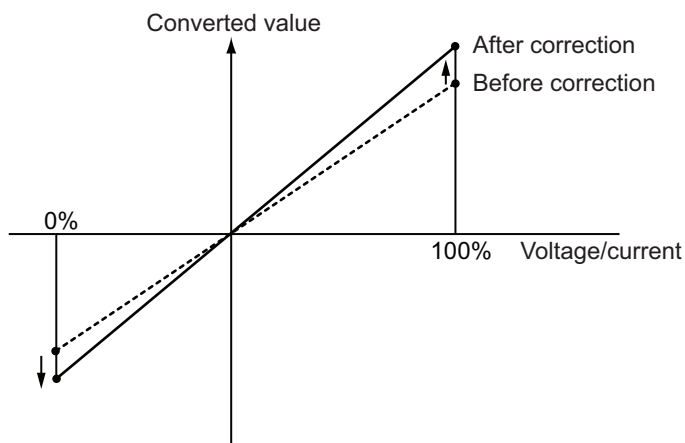

● Correctable Range

The correctable range is -5 to 5% of the input full scale.

The correctable range for each input range is as follows.

Input range	Correctable range	
	0%	100%
-10 to +10 V	-11 to -9.0 V	9.0 to 11 V
4 to 20 mA	3.2 to 4.8 mA	19.2 to 20.8 mA

Target NX Units

All Analog Input Units

Setting Method

This section describes how to configure settings with the Sysmac Studio.

You can perform the user calibration even if you are using Support Software other than the Sysmac Studio.

For details on how to configure the user calibration settings with Support Software other than Sysmac Studio, refer to the operation manual for the Support Software that you are using.

- 1 Right-click the NX Unit, then select *User Calibration* from the menu.

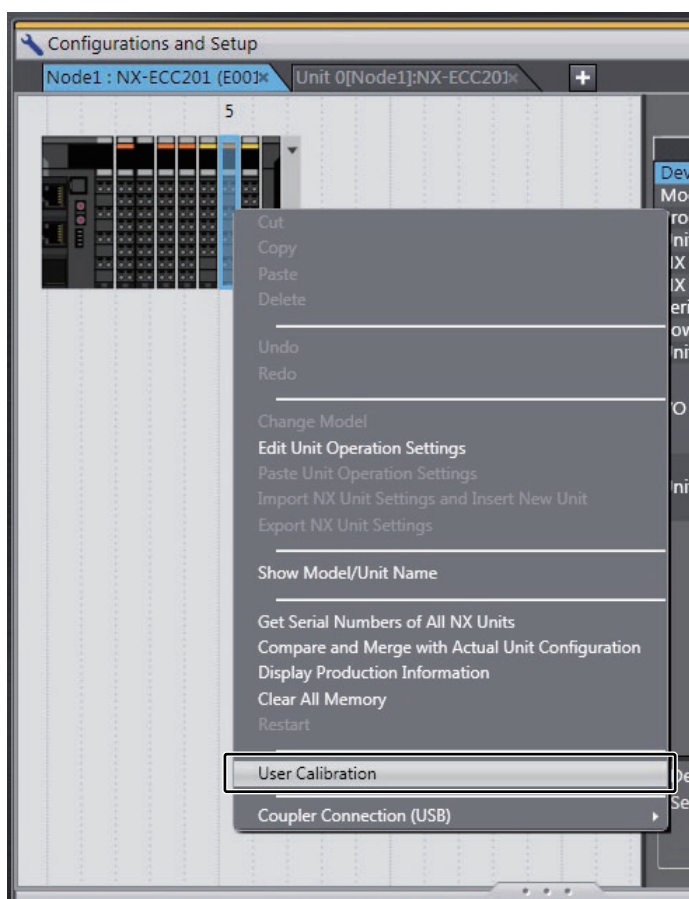

- 2** Select the channel you want to calibrate from **Channel**.

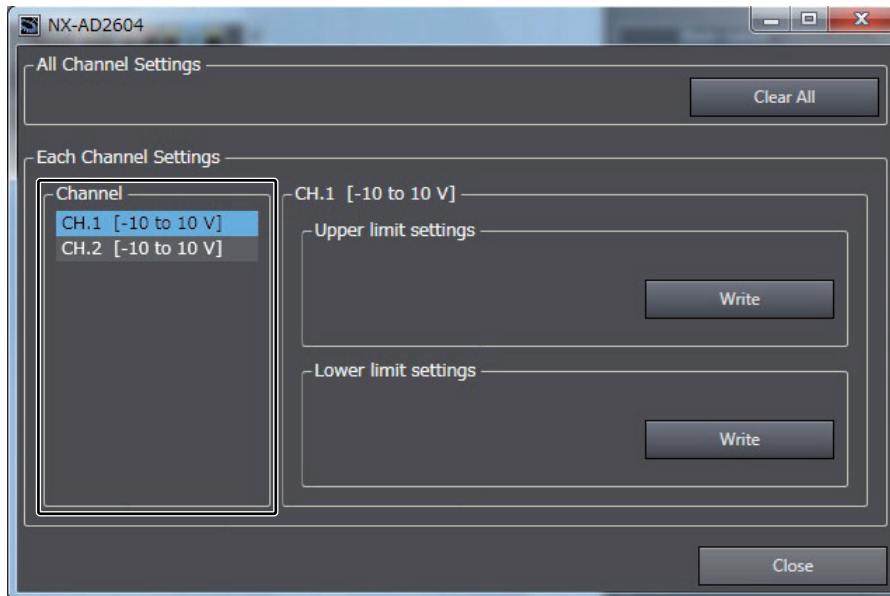

- 3** Enter the voltage or current corresponding to upper limit (100%) to the Unit terminal, then click the **Write** Button under **Upper limit settings**.

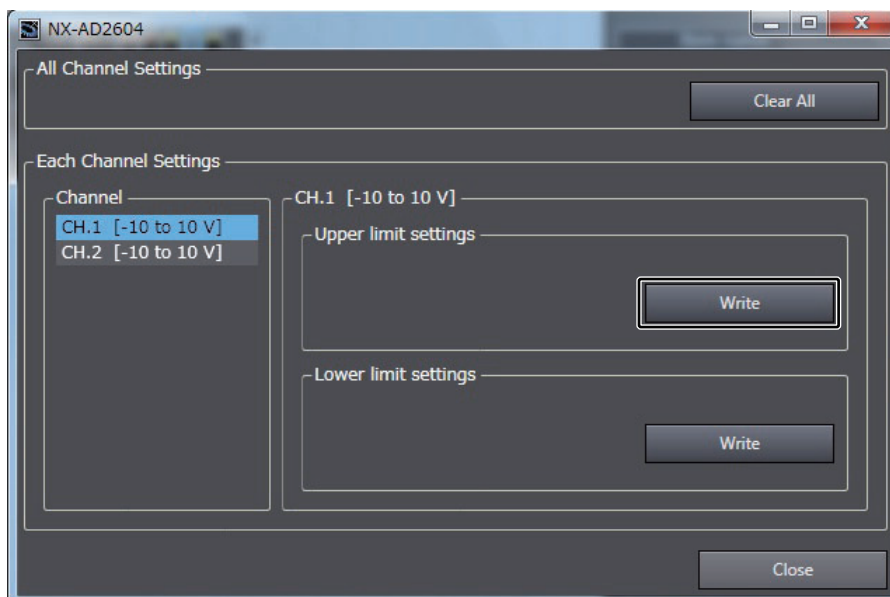

- 4** Click the **Yes** Button on the confirmation message.

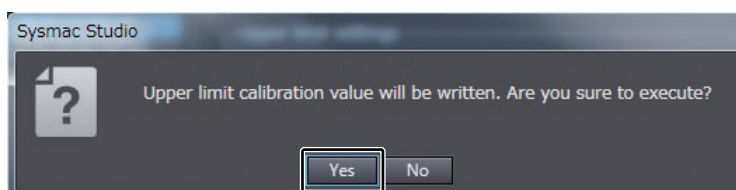

When the writing is completed successfully, the following message is displayed. Click the **OK** Button.

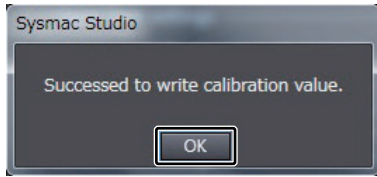

- 5** Enter the voltage or current corresponding to lower limit (0%) to the Unit terminal, then click the **Write** Button under **Lower limit settings**.

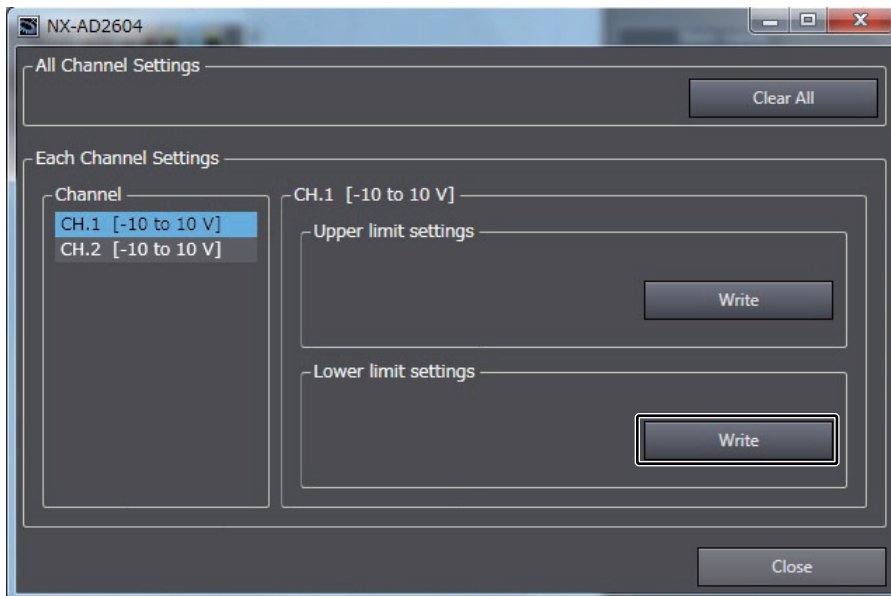

- 6** Click the **Yes** Button on the confirmation message.

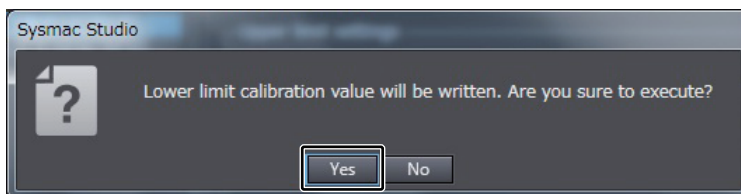

When the writing is completed successfully, the following message is displayed. Click the **OK** Button.

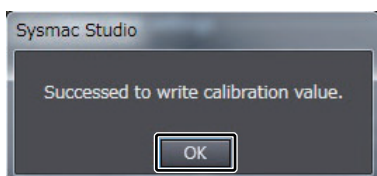



Additional Information

- A new calibration value is reflected immediately after you write it.
- When you write a calibration value, if the voltage or current that is input to the Unit terminal is outside the correctable range, the following message will be displayed and calibration will fail. The following message appears in the case of a Slave Terminal.

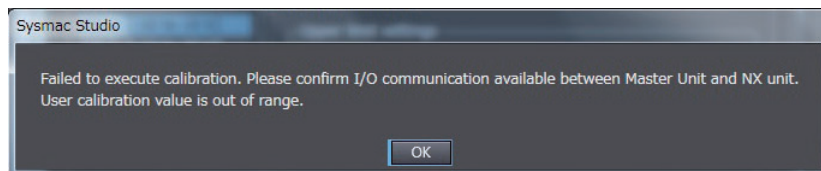

● **Reset the Calibration Value to the Default**

You can reset the calibration value to the default.

- 1 Right-click the NX Unit, then select **User Calibration** from the menu.

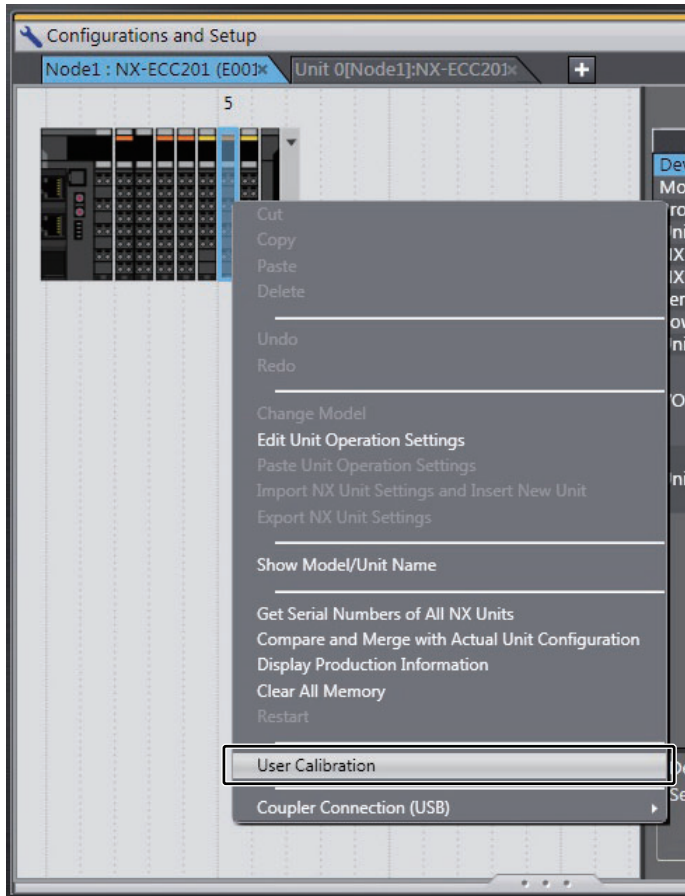

- 2 Click the **Clear All** Button under All Channel Settings.

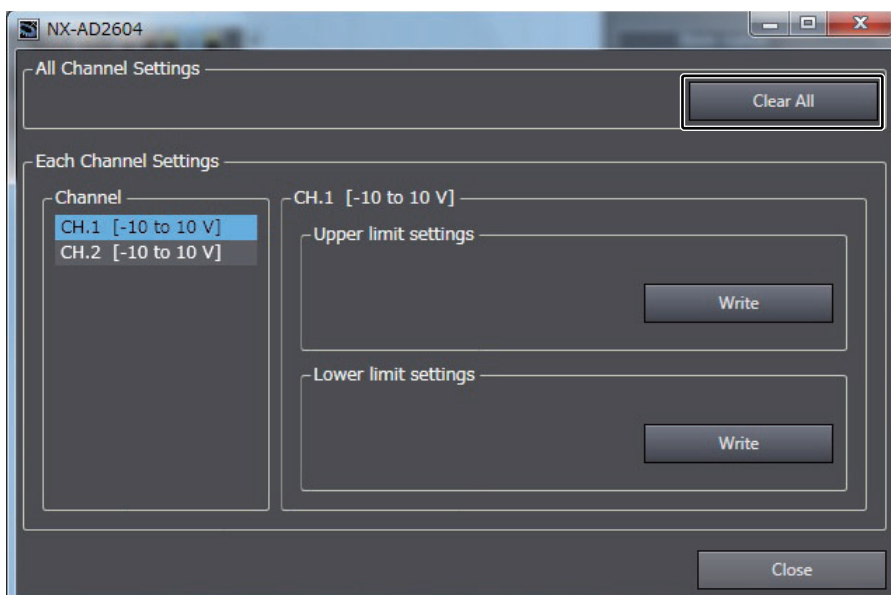

- 3** Click the **Yes** Button on the confirmation message.

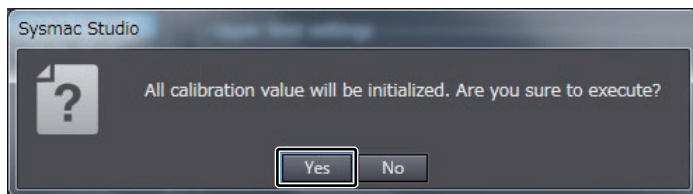

When the writing is completed successfully, the following message is displayed. Click the **OK** Button.

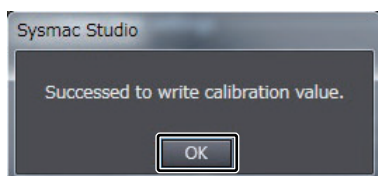

7

Analog Output Units

This section describes the types and functions of Analog Output Units.

7-1	Types of Analog Output Units	7-2
7-2	Output Range and Output Set Values	7-3
7-3	Specifications of I/O Data	7-5
7-3-1	Allocable I/O Data	7-5
7-4	List of Settings	7-6
7-5	Functions	7-9
7-5-1	List of Analog Output Unit Functions	7-9
7-5-2	Selecting Channel To Use	7-10
7-5-3	Load Rejection Output Setting	7-14
7-5-4	Over Range/Under Range Detection	7-19
7-5-5	User Calibration	7-20

7-1 Types of Analog Output Units

Analog Output Units are the NX Units with functionality to convert output set values set by the user program to analog signals such as -10 to 10 V and 4 to 20 mA.

The Analog Output Unit types are described below.

Analog Output Units (Screwless Clamping Terminal Block, 12 mm Width)

Model	Number of points	Output range	Resolution	I/O refreshing method	Conversion time	Reference
NX-DA2203	2 points	4 to 20 mA	1/8000	Free-Run refreshing	250 μ s/point	P. A-25
NX-DA2205			1/30000	Switching Synchronous I/O refreshing and Free-Run refreshing	10 μ s/point	P. A-27
NX-DA2603		-10 to +10 V	1/8000	Free-Run refreshing	250 μ s/point	P. A-29
NX-DA2605			1/30000	Switching Synchronous I/O refreshing and Free-Run refreshing	10 μ s/point	P. A-30
NX-DA3203	4 points	4 to 20 mA	1/8000	Free-Run refreshing	250 μ s/point	P. A-31
NX-DA3205			1/30000	Switching Synchronous I/O refreshing and Free-Run refreshing	10 μ s/point	P. A-33
NX-DA3603		-10 to +10 V	1/8000	Free-Run refreshing	250 μ s/point	P. A-35
NX-DA3605			1/30000	Switching Synchronous I/O refreshing and Free-Run refreshing	10 μ s/point	P. A-36

7-2 Output Range and Output Set Values

Output set values set by the user program are converted to analog signals according to the output range shown below.

If the output set value exceeds the value range for which conversion is possible, the analog value is fixed at the upper or lower limit.

Output Range: -10 to +10 V

● 1/8000 Resolution

The output set value of the signed integer (-4000 to +4000) is converted to voltage from -10 to +10 V and output.

The output set value range for which conversion is possible is the signed integer (-4400 to +4400) and for this case the output voltage becomes from -11 to +11 V.

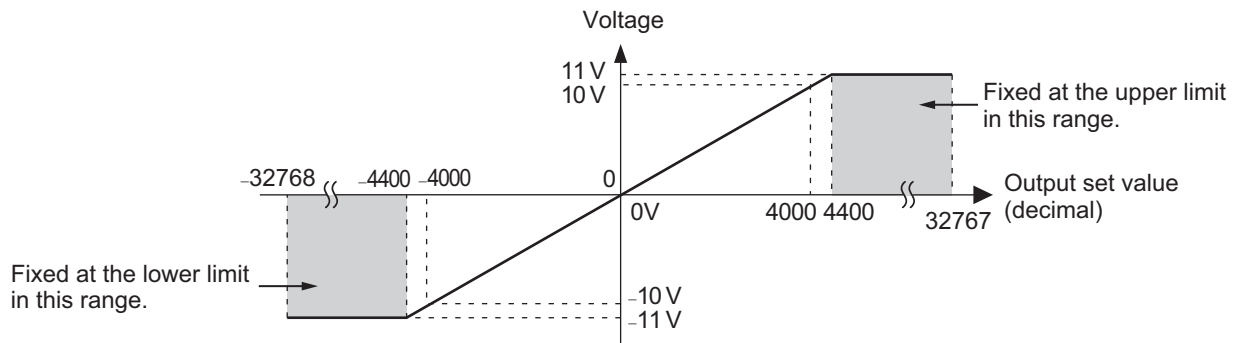

● 1/30000 Resolution

The output set value of the signed integer (-15000 to +15000) is converted to voltage from -10 to +10 V and output.

The output set value range for which conversion is possible is the signed integer (-16500 to +16500) and for this case the output voltage becomes from -11 to +11 V.

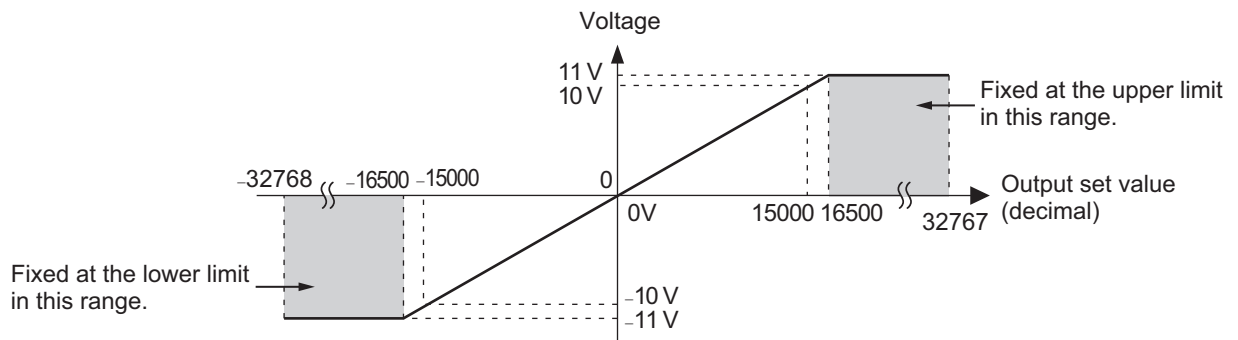

Output Range: 4 to 20 mA

● 1/8000 Resolution

The output set value of the signed integer value (0 to 8000) is converted to currents from 4 to 20 mA and output.

The output set value range for which conversion is possible is the signed integer (-400 to +8400) and for this case the output voltage becomes from 3.2 to 20.8 mA.

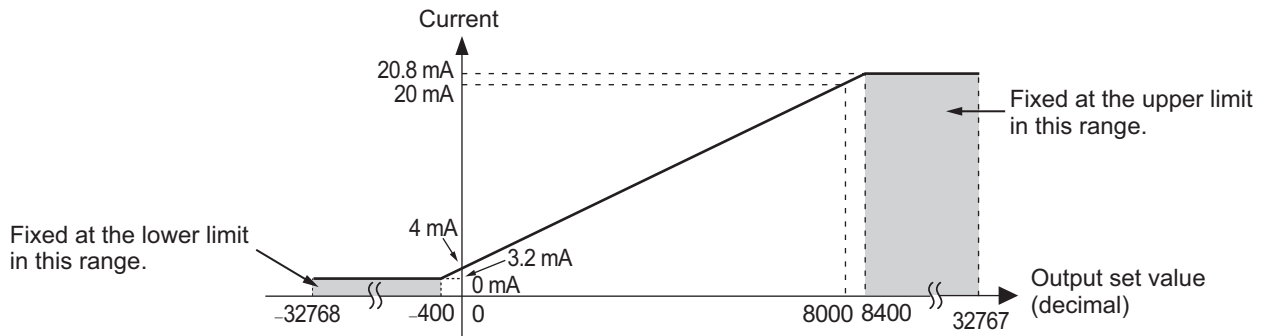

● 1/30000 Resolution

The output set value of the signed integer (0 to 30000) is converted to current from 4 to 20 mA and output.

The output set value range for which conversion is possible is the signed integer (-1500 to +31500) and for this case the output voltage becomes from 3.2 to 20.8 mA.

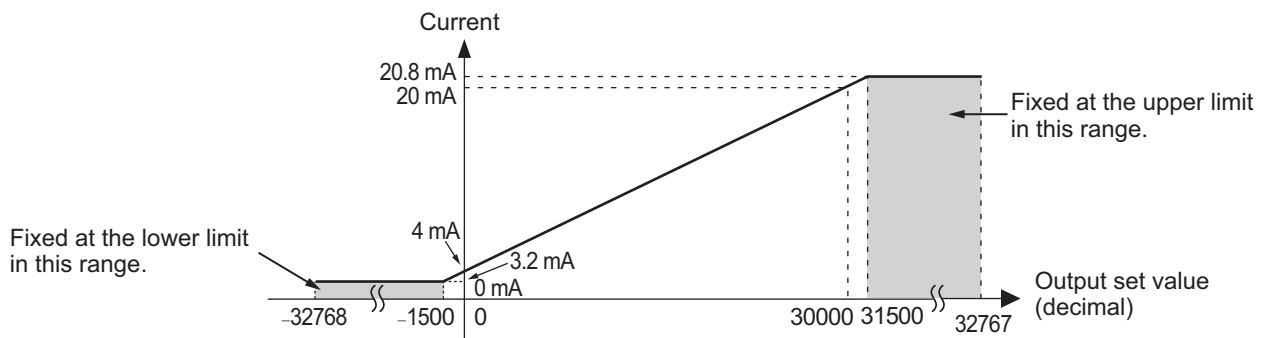

7-3 Specifications of I/O Data

This section describes the I/O data for the Analog Output Units.

7-3-1 Allocable I/O Data

This section describes the allocable I/O data in the Analog Output Unit.

An I/O entry mapping is assigned to the I/O allocation settings for the Analog Output Unit.

A specific I/O entry is assigned to the I/O entry mapping for each NX Unit model. These allocations are fixed, so you cannot add others or change them.

An I/O entry means the I/O data described in this section. An I/O entry mapping means a collection of I/O entries.

To assign the I/O allocation information of the NX Unit or Slave Terminal to an NJ/NX-series CPU Unit or NY-series Industrial PC, use the I/O ports for the allocated I/O data.

However, for Slave Terminals, I/O ports may not be used depending on the type of communications master or Communications Coupler Unit.

Refer to the user's manual for the connected Communications Coupler Unit for details on how to use I/O data for Slave Terminals.

Refer to the user's manual for the Communication Control Unit for details on how to use I/O data for Communication Control Units.

● Two-point Output Units

Data name	Description	Data type	Default value	I/O port name	Index	Subindex
Ch1 Analog Output Value	Value of analog output Ch1	INT	0	Ch1 Analog Output Value	7000 hex	01 hex
Ch2 Analog Output Value	Value of analog output Ch2	INT	0	Ch2 Analog Output Value		02 hex

● Four-point Output Units

Data name	Description	Data type	Default value	I/O port name	Index	Subindex
Ch1 Analog Output Value	Value of analog output Ch1	INT	0	Ch1 Analog Output Value	7000 hex	01 hex
Ch2 Analog Output Value	Value of analog output Ch2	INT	0	Ch2 Analog Output Value		02 hex
Ch3 Analog Output Value	Value of analog output Ch3	INT	0	Ch3 Analog Output Value		03 hex
Ch4 Analog Output Value	Value of analog output Ch4	INT	0	Ch4 Analog Output Value		04 hex

7-4 List of Settings

The followings are the setting descriptions, setting ranges, and default values of the functions that can be used in the Analog Output Units.

The settings are reflected after the Unit is restarted.



Precautions for Safe Use

The Unit is required to restart after the transfer of Unit operation settings on the Support Software is completed. Always sufficiently check the safety at the connected devices before you transfer the Unit operation settings.

● Two-point Output Units

Setting name	Description	Default value	Setting range	Unit	Index	Sub-index	Reference
Ch1 Enable/Disable	Set to enable or disable the channel.	TRUE	TRUE or FALSE	---	5010 hex	01 hex	P. 7-10
Ch2 Enable/Disable	FALSE: Disable TRUE: Enable	TRUE	TRUE or FALSE	---		02 hex	
Ch1 Range Setting	Set the range.	*1	*1	---	5011 hex	01 hex	P. 7-3
Ch2 Range Setting	0: 4 to 20 mA 1: 0 to 10 V 2: -10 to +10 V 3: 0 to 5 V 4: 1 to 5 V 5: 0 to 20 mA	*1	*1	---		02 hex	
Ch1 Hold Value Setting	Set the value to output at load OFF.	4	0 to 4 *2	---	5012 hex	01 hex	P. 7-14
Ch1 User-specified Value Setting	Set the value to output when the Load OFF Output Setting is set to output the user specified value.	0	-32768 to 32767	---		02 hex	
Ch2 Hold Value Setting	Set the value to output at load OFF.	4	0 to 4 *2	---		03 hex	
Ch2 User-specified Value Setting	Set the value to output when the Load OFF Output Setting is set to output the user specified value.	0	-32768 to 32767	---		04 hex	

*1. The default value and setting range of Ch□ Range Setting depend on the model. The default value and setting range for each NX Unit are as follows.

NX Units	Default value	Setting range
NX-DA2203/DA2205	0	0
NX-DA2603/DA2605	2	2

*2. The descriptions of Ch□ Hold Value Setting are as follows.

Set value	Setting description
0	Hold Last State
1	Low Limit
2	High Limit
3	User Count
4	Zero Count

● Four-point Output Units

Setting name	Description	Default value	Setting range	Unit	Index	Sub-index	Reference
Ch1 Enable/Disable	Set to enable or disable the channel. FALSE: Disable TRUE: Enable	TRUE	TRUE or FALSE	---	5010 hex	01 hex	P. 7-10
Ch2 Enable/Disable		TRUE	TRUE or FALSE	---		02 hex	
Ch3 Enable/Disable		TRUE	TRUE or FALSE	---		03 hex	
Ch4 Enable/Disable		TRUE	TRUE or FALSE	---		04 hex	
Ch1 Range Setting	Set the range. 0: 4 to 20 mA 1: 0 to 10 V 2: -10 to +10 V 3: 0 to 5 V 4: 1 to 5 V 5: 0 to 20 mA	*1	*1	---	5011 hex	01 hex	P. 7-3
Ch2 Range Setting		*1	*1	---		02 hex	
Ch3 Range Setting		*1	*1	---		03 hex	
Ch4 Range Setting		*1	*1	---		04 hex	
Ch1 Hold Value Setting	Set the value to output at load OFF.	4	0 to 4 *2	---	5012 hex	01 hex	P. 7-14
Ch1 User-specified Value Setting	Set the value to output when the Load OFF Output Setting is set to output the user specified value.	0	-32768 to 32767	---		02 hex	
Ch2 Hold Value Setting	Set the value to output at load OFF.	4	0 to 4 *2	---		03 hex	
Ch2 User-specified Value Setting	Set the value to output when the Load OFF Output Setting is set to output the user specified value.	0	-32768 to 32767	---		04 hex	
Ch3 Hold Value Setting	Set the value to output at load OFF.	4	0 to 4 *2	---	5012 hex	05 hex	P. 7-14
Ch3 User-specified Value Setting	Set the value to output when the Load OFF Output Setting is set to output the user specified value.	0	-32768 to 32767	---		06 hex	
Ch4 Hold Value Setting	Set the value to output at load OFF.	4	0 to 4 *2	---		07 hex	
Ch4 User-specified Value Setting	Set the value to output when the Load OFF Output Setting is set to output the user specified value.	0	-32768 to 32767	---		08 hex	

- *1. The default value and setting range of Ch□ Range Setting depend on the model. The default value and setting range for each NX Unit are as follows.

NX Units	Default value	Setting range
NX-DA3203/DA3205	0	0
NX-DA3603/DA3605	2	2

- *2. The descriptions of Ch□ Hold Value Setting are as follows.

Set value	Setting description
0	Hold Last State
1	Low Limit
2	High Limit
3	User Count
4	Zero Count

7-5 Functions

This section describes the Analog Output Unit functions.

Refer to the specifications of each model in *A-1 Data Sheet* on page A-2, for details on the functions.

7-5-1 List of Analog Output Unit Functions

Function name	Description	Reference
Free-Run Refreshing	With this I/O refreshing method, the refresh cycle of the NX bus and the I/O refresh cycles of the NX Units are asynchronous.	5-2-4 <i>Free-Run Refreshing</i> on page 5-9
Synchronous I/O Refreshing	With this I/O refreshing method, the timing to read inputs or to refresh outputs is synchronized on a fixed interval between more than one NX Unit connected to a CPU Unit. In addition, with this I/O refreshing method, the timing to read inputs or to refresh outputs is synchronized on a fixed interval between more than one NX Unit on more than one Slave Terminal.	5-2-6 <i>Synchronous Output Refreshing</i> on page 5-17
Selecting Channel To Use	This function omits the conversion processing for unused inputs. It is used to reduce the conversion cycle for its own Unit.	7-5-2 <i>Selecting Channel To Use</i> on page 7-10
Load Rejection Output Setting	A function that performs the preset output operation when the Analog Output Unit cannot receive output data due to the following causes: When the Unit is connected to a CPU Unit: NX bus error, CPU Unit watchdog timer error, etc. When the Unit is connected to a Communications Coupler Unit: Host error on the Communications Coupler Unit, NX bus error, etc. When the Unit is connected to a Communication Control Unit: NX bus error, Communication Control Unit watchdog timer error, etc.	7-5-3 <i>Load Rejection Output Setting</i> on page 7-14
Over Range/Under Range Detection	This function detects when the output set value exceeds the range for which conversion is possible.	7-5-4 <i>Over Range/Under Range Detection</i> on page 7-19
User Calibration	This function corrects offsets in the converted values that occur due to the deterioration of the NX Units and calibrate the Units.	7-5-5 <i>User Calibration</i> on page 7-20

7-5-2 Selecting Channel To Use

Purpose

This function skips the conversion processing and error detection processing for unused outputs, and shortens the conversion time.

Details on the Function

Normally in this Unit, the output set values for the number of input points mounted are converted in sequence. The setting can be changed so that unused outputs are not converted.

By reducing the number of conversion points, the conversion time is shortened.

Whether the channel is enabled or disabled is settable for each output.

However, set the Ch□ Enable/Disable parameter to *Enable* for at least one channel for a Unit.

If you disabled all channels for a Unit, an NX Unit Initialization Error event (event code: 84C10000 hex) occurs.

Refer to the user's manual for the Communications Coupler Unit for details on events.

● Two-point Output Units

Setting name	Description	Default value	Unit
Ch1 Enable/Disable	Set to enable or disable the channel.	TRUE	---
Ch2 Enable/Disable		TRUE	---
	FALSE: Disable TRUE: Enable		

● Four-point Output Units

Setting name	Description	Default value	Unit
Ch1 Enable/Disable	Set to enable or disable the channel.	TRUE	---
Ch2 Enable/Disable		TRUE	---
Ch3 Enable/Disable		TRUE	---
Ch4 Enable/Disable		TRUE	---
	FALSE: Disable TRUE: Enable		

Target NX Units

All Analog Output Units

Setting Method

This section describes how to configure settings with the Sysmac Studio.

When you are using Support Software other than the Sysmac Studio, in the Edit Unit Operation Settings Tab Page, set the parameters described in the procedure and transfer the settings to the target NX Unit.

For details on how to display the Edit Unit Operation Settings Tab Page and to transfer settings to an NX Unit with Support Software other than the Sysmac Studio, refer to the operation manual for the Support Software that you are using.

- 1 Display the Edit Unit Operation Settings Tab Page.
For the display methods, refer to *A-8 Displaying the Edit Unit Operation Settings Tab Page* on page A-63.
- 2 Select *True* (Enable) or *False* (Disable) from the list of Output Enable/Disable Setting for which the channel you want to set.

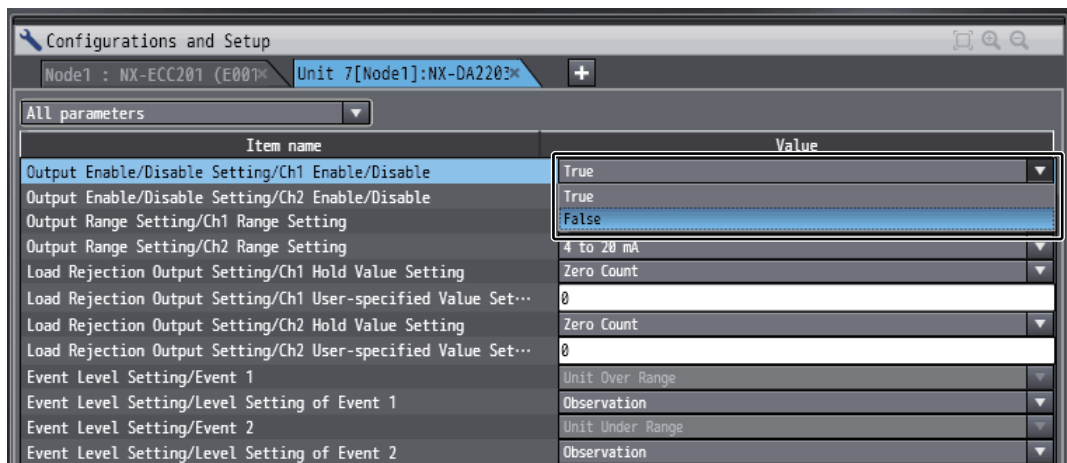



Additional Information

- Click a list button on the tab page to display the item in the Edit Unit Operation Settings Tab Page.

Example:

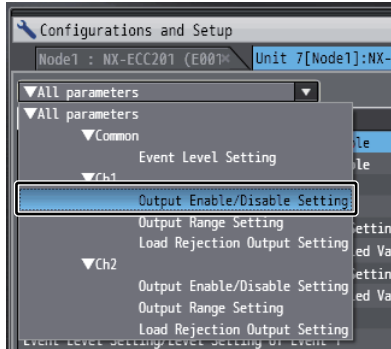

Select Output Enable/Disable Setting under Ch1

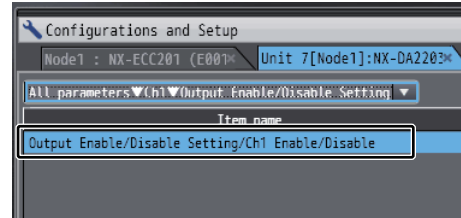

Only Output Enable/Disable Setting under Ch1 is displayed

- If you set a value different from the default value, the Value on the Sysmac Studio is displayed in a different color.
- You can click the **Return to Default Value** Button to return all set values on the Sysmac Studio to the default values.
- Help for the settings is displayed at the bottom of the Edit Unit Operation Settings Tab Page.

3 Click the **Transfer to Unit** Button.

The settings are transferred from the Sysmac Studio to the NX Unit.

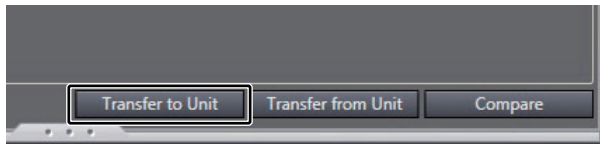

The settings are reflected after the Unit is restarted.



Precautions for Safe Use

The Unit is required to restart after the transfer of Unit operation settings on the Support Software is completed. Always sufficiently check the safety at the connected devices before you transfer the Unit operation settings.

Calculating Conversion Time

The conversion time per Unit according to the number of available conversion channels is as follows.

Number of available conversion channels	Conversion time per unit (μs)	
	Conversion time: 250 $\mu\text{s}/\text{point}$	Conversion time: 10 $\mu\text{s}/\text{point}$
1 channel	250	10
2 channels	500	20
3 channels	750	30
4 channels	1000	40
5 channels	1250	50
6 channels	1500	60
7 channels	1750	70
8 channels	2000	80

7-5-3 Load Rejection Output Setting

Purpose

This function maintains a safe output status by performing the preset output operations when the Analog Output Unit cannot receive output data from a remote device due to the following causes:

When the Unit is connected to a CPU Unit: NX bus error, CPU Unit watchdog timer error, etc.

When the Unit is connected to a Communications Coupler Unit: Host error on the Communications Coupler Unit, NX bus error, etc.

When the Unit is connected to a Communication Control Unit: NX bus error, Communication Control Unit watchdog timer error, etc.

Details on the Function

Set the output value from any of the following for each output when an error occurs.

Setting description	Meaning	Set value	
		Output range -10 to +10 V	Output range 4 to 20 mA
Hold Last State	Hold and output the value immediately before the error occurred.	Hold	Hold
Low Limit	Output the lower limit of each output range.	-11 V	3.2 mA
High Limit	Output the upper limit of each output range	11 V	20.8 mA
User Count	Output the user-specified value.	User specified value	User specified value
Zero Count	Output the analog value if the output set value of each output range is 0 (default).	0 V	4 mA

● Two-point Output Units

Setting name	Description	Default value	Unit
Ch1 Hold Value Setting	Set the value to output at load OFF. *1	4	---
Ch1 User-specified Value Setting	Set the value to output when the Load OFF Output Setting is set to output the user specified value.	0	---
Ch2 Hold Value Setting	Set the value to output at load OFF. *1	4	---
Ch2 User-specified Value Setting	Set the value to output when the Load OFF Output Setting is set to output the user specified value.	0	---

*1. The descriptions of Ch□ Hold Value Setting are as follows.

Set value	Setting description
0	Hold Last State
1	Low Limit
2	High Limit
3	User Count
4	Zero Count

● Four-point Output Units

Setting name	Description	Default value	Unit
Ch1 Hold Value Setting	Set the value to output at load OFF. *1	4	---
Ch1 User-specified Value Setting	Set the value to output when the Load OFF Output Setting is set to output the user specified value.	0	---
Ch2 Hold Value Setting	Set the value to output at load OFF. *1	4	---
Ch2 User-specified Value Setting	Set the value to output when the Load OFF Output Setting is set to output the user specified value.	0	---
Ch3 Hold Value Setting	Set the value to output at load OFF. *1	4	---
Ch3 User-specified Value Setting	Set the value to output when the Load OFF Output Setting is set to output the user specified value.	0	---
Ch4 Hold Value Setting	Set the value to output at load OFF. *1	4	---
Ch4 User-specified Value Setting	Set the value to output when the Load OFF Output Setting is set to output the user specified value.	0	---

*1. The descriptions of Ch□ Hold Value Setting are as follows.

Set value	Setting description
0	Hold Last State
1	Low Limit
2	High Limit
3	User Count
4	Zero Count

Target NX Units

All Analog Output Units

Setting Method

This section describes how to configure settings with the Sysmac Studio.

When you are using Support Software other than the Sysmac Studio, in the Edit Unit Operation Settings Tab Page, set the parameters described in the procedure and transfer the settings to the target NX Unit.

For details on how to display the Edit Unit Operation Settings Tab Page and to transfer settings to an NX Unit with Support Software other than the Sysmac Studio, refer to the operation manual for the Support Software that you are using.

- 1 Display the Edit Unit Operation Settings Tab Page.
For the display methods, refer to *A-8 Displaying the Edit Unit Operation Settings Tab Page* on page A-63.
- 2 Select the output from the list of **Load Rejection Output Setting** for which the channel you want to set.

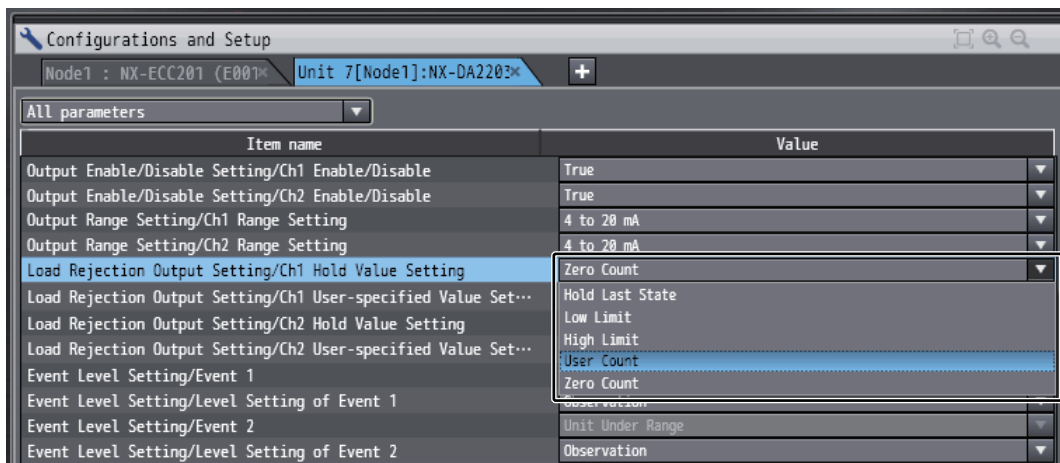



Additional Information

- Click a list button on the tab page to display the item in the Edit Unit Operation Settings Tab Page.

Example:

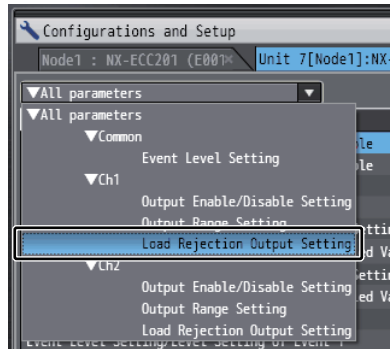

Select Load Rejection Output Setting under Ch1

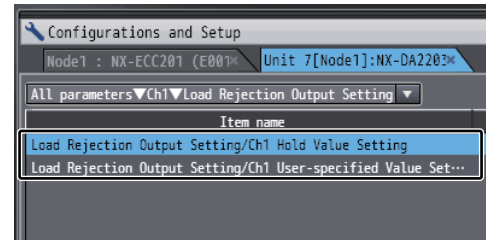

Only Load Rejection Output Setting under Ch1 is displayed

- If you set a value different from the default value, the Value on the Sysmac Studio is displayed in a different color.
- You can click the **Return to Default Value** Button to return all set values on the Sysmac Studio to the default values.
- Help for the settings is displayed at the bottom of the Edit Unit Operation Settings Tab Page.

If you select *User Count*, enter an analog output value (-32768 to 32767) in the text box of Ch1 User-specified Value Setting.

Item name	Value
Output Enable/Disable Setting/Ch1 Enable/Disable	True
Output Enable/Disable Setting/Ch2 Enable/Disable	True
Output Range Setting/Ch1 Range Setting	4 to 20 mA
Output Range Setting/Ch2 Range Setting	4 to 20 mA
Load Rejection Output Setting/Ch1 Hold Value Setting	User Count
Load Rejection Output Setting/Ch1 User-specified Value Set...	10000
Load Rejection Output Setting/Ch2 Hold Value Setting	Zero Count
Load Rejection Output Setting/Ch2 User-specified Value Set...	0
Event Level Setting/Event 1	Unit Over Range
Event Level Setting/Level Setting of Event 1	Observation
Event Level Setting/Event 2	Unit Under Range
Event Level Setting/Level Setting of Event 2	Observation



Additional Information

This set value is invalid except for User Count.

3 Click the **Transfer to Unit** Button.

The settings are transferred from the Sysmac Studio to the NX Unit.

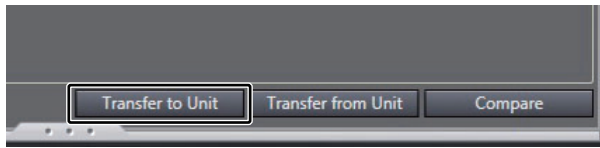

The settings are reflected after the Unit is restarted.



Precautions for Safe Use

The Unit is required to restart after the transfer of Unit operation settings on the Support Software is completed. Always sufficiently check the safety at the connected devices before you transfer the Unit operation settings.

7-5-4 Over Range/Under Range Detection

Purpose

This function detects when the output set value exceeds the range for which conversion is possible.

Details on the Function

- If the output set value exceeds the upper limit of the conversion range, the converted value is fixed at the upper limit. At this time, the Over Range Status turns ON and a Unit Over Range for Channel□ event (event code: 64F00000 to 64F70000 hex) occurs.
- If the output set value falls below the lower limit of the conversion range, the converted value is fixed at the lower limit. At this time, the Under Range Status turns ON and a Unit Under Range for Channel□ event (event code: 64F80000 to 64FF0000 hex) occurs.
- When the output set value returns to the conversion range, the fixing is cancelled and the value becomes the normal converted value. When the cause of the error is removed and the error is reset, the Over Range/Under Range Status turns OFF.
- Refer to *A-3 List of NX Objects* on page A-39 for details on status and *8-3-3 Event Codes and Corrections for Errors* on page 8-7 for details on events.

Target NX Units

All Analog Output Units

Setting Method

No setting is required.

7-5-5 User Calibration

Purpose

This function corrects offsets in the output voltages and output currents that occur due to the deterioration of the NX Units and calibrate the Units again.

You can use this function to calibrate the equipment that requires the periodic calibration.

Details on the Function

This function corrects the converted values of output voltages and output currents at 2 points, 0% and 100%, as shown in the figure below.

The calibration result is saved in the NX Unit.

● Calibration Example 1

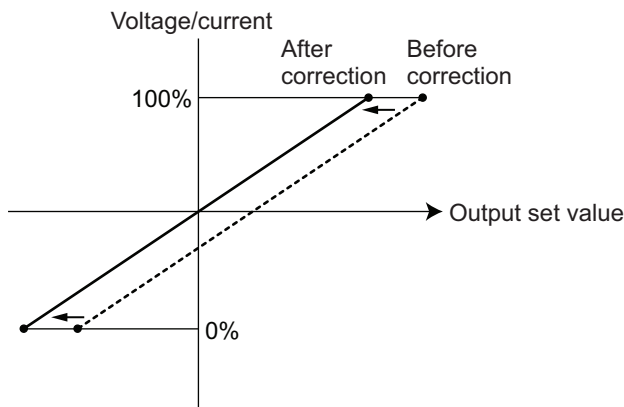

● Calibration Example 2

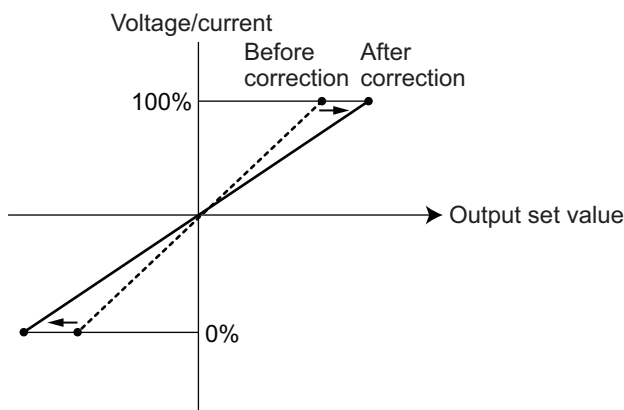

● Correctable Range

The correctable range is -5 to +5% of the output full scale.

The correctable range for each output range is as follows.

Output range	Correctable range	
	0%	100%
-10 to +10 V	-11 to -9.0 V	9.0 to 11 V
4 to 20 mA	3.2 to 4.8 mA	19.2 to 20.8 mA

Target NX Units

All Analog Output Units

Setting Method

This section describes how to configure settings with the Sysmac Studio.

You can perform the user calibration even if you are using Support Software other than the Sysmac Studio.

For details on how to configure the user calibration settings with Support Software other than Sysmac Studio, refer to the operation manual for the Support Software that you are using.

- 1 Right-click the NX Unit, then select **User Calibration** from the menu.

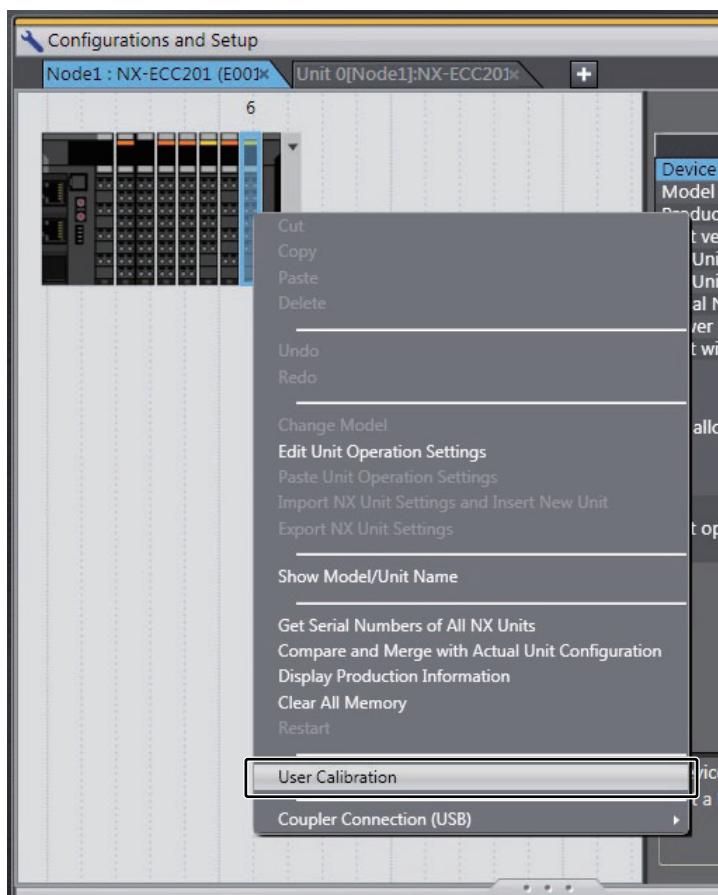

- 2 Select the channel you want to calibrate from **Channel**.

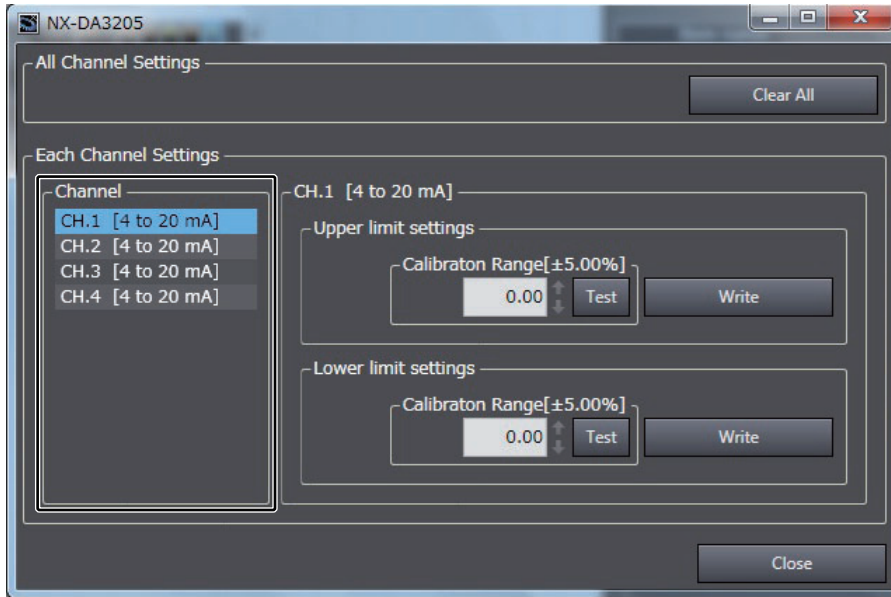

- 3 Set the minimum value (0%) of Output Unit as the output set value for the channel you want to calibrate.
- 4 Change the value of **Calibration Range** under **Lower limit settings** to calibrate the value of an analog signal that is output from the terminal.

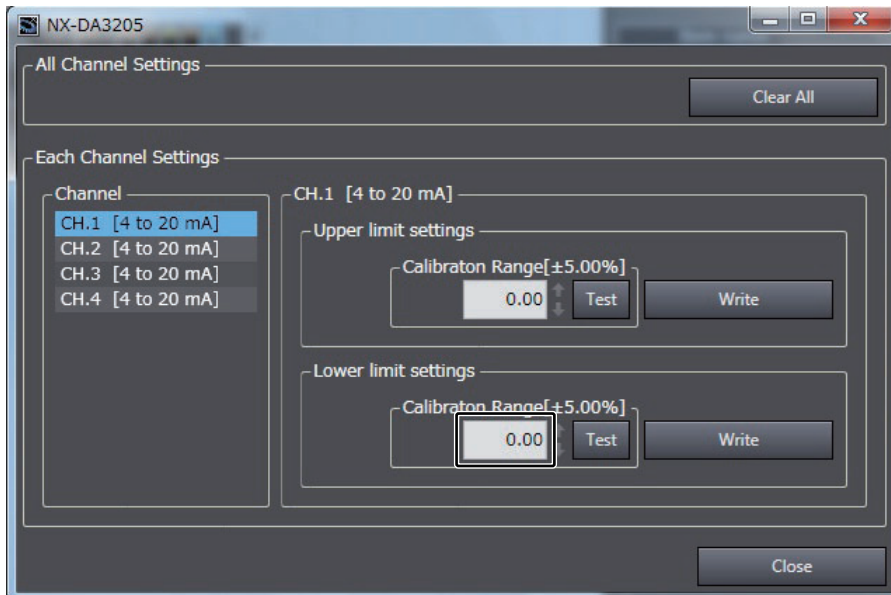

- 5 Click the **Test** Button to output the value of an analog signal that was calibrated in Procedure 4.

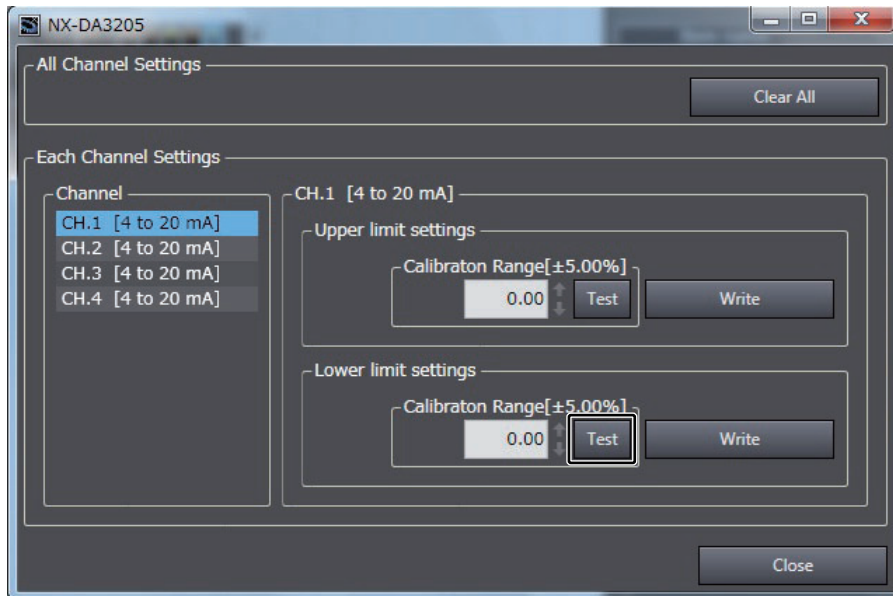

Make the calibration to correctly output the value of 0% analog signal from the terminal.

- 6 After you complete the calibration, click the **Write** Button under **Lower limit settings**.

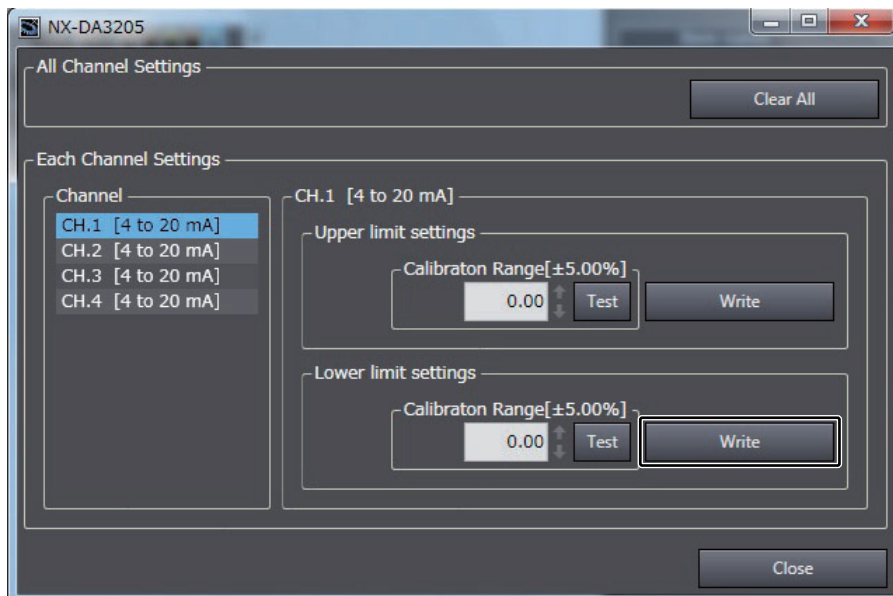

- 7 Click the **Yes** Button on the confirmation message.

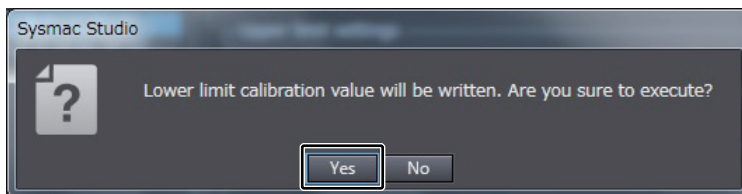

When the writing is completed successfully, the following message is displayed. Click the **OK** Button.

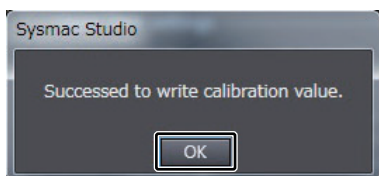

- 8 Set the maximum value (100%) of Output Unit as the output set value for the channel you want to calibrate.
- 9 Change the value of **Calibration Range** under **Upper limit settings** to calibrate the value of an analog signal that is output from the terminal.

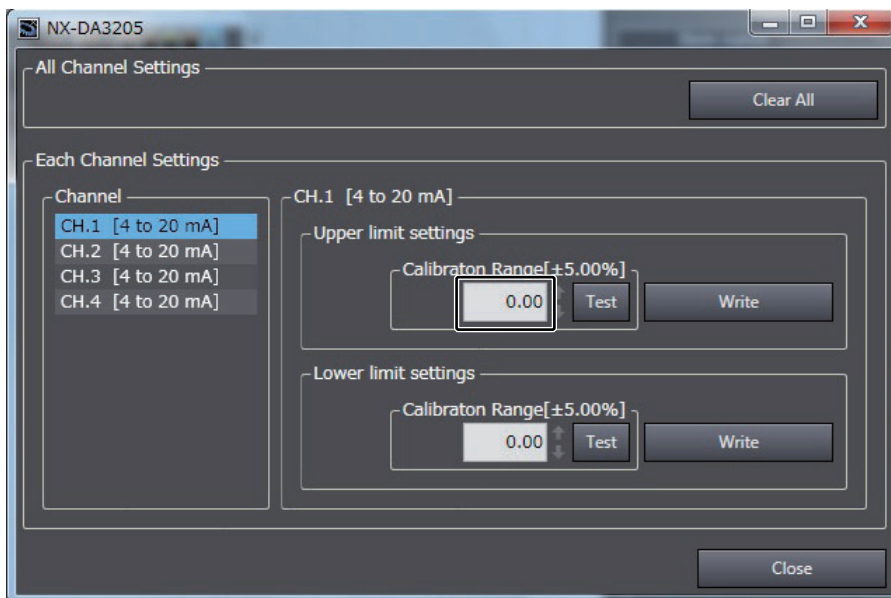

- 10** Click the **Test** Button to output the value of an analog signal that was calibrated in Procedure 9.

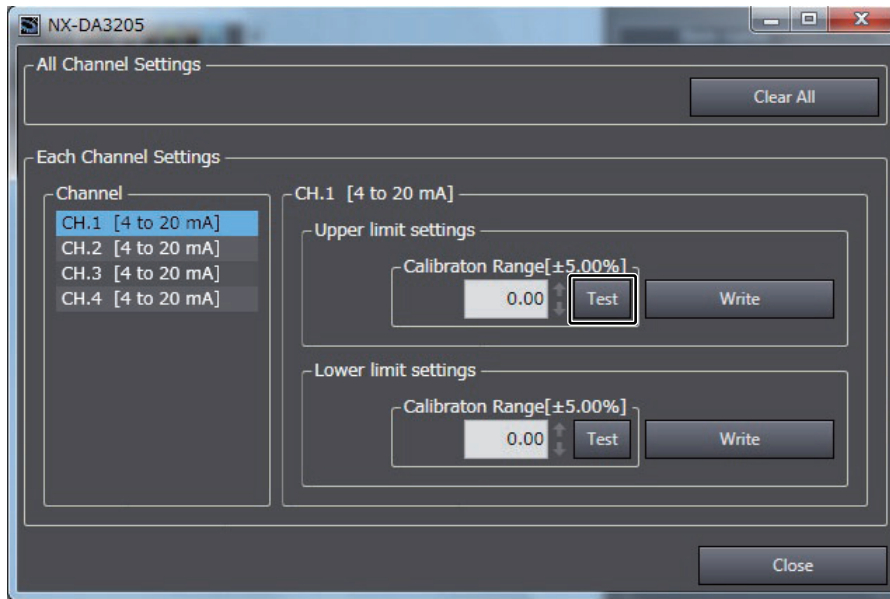

Make the calibration to correctly output the value of 100% analog signal from the terminal.

- 11** After you complete the calibration, click the **Write** Button under **Upper limit settings**.

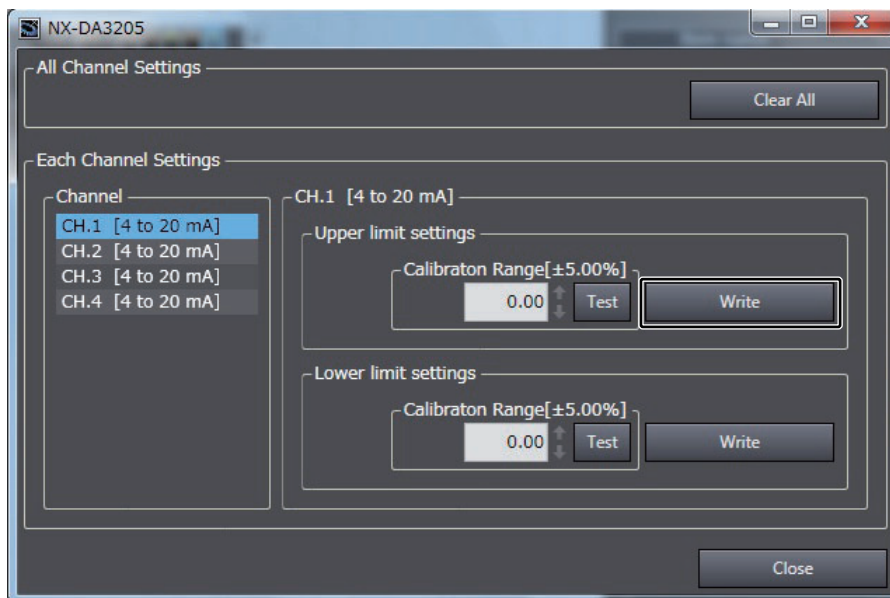

12 Click the **Yes** Button on the confirmation message.

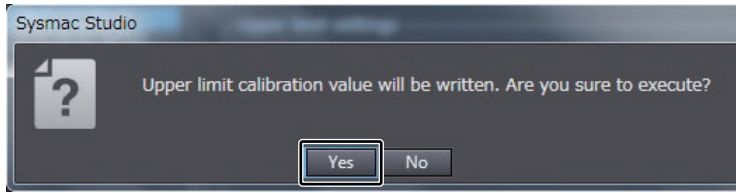

When the writing is completed successfully, the following message is displayed. Click the **OK** Button.

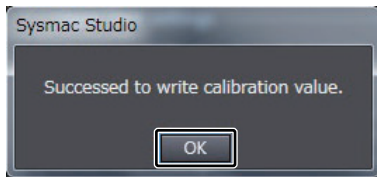

Additional Information

For the upper limit calibration value and lower limit calibration value, you cannot write the calibration value on the Unit if only click the **Test** Button. To write the calibration value, click the **Write** Button.

- **Reset the Calibration Value to the Default**

You can reset the calibration value to the default.

- 1 Right-click the NX Unit, then select **User Calibration** from the menu.

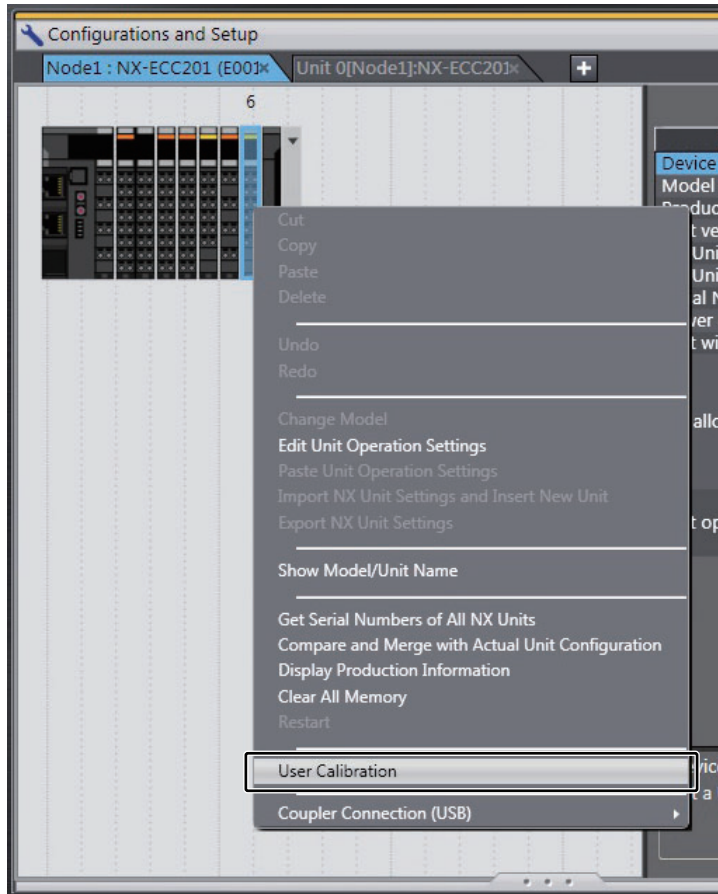

- 2 Click the **Clear All** Button under **All Channel Settings**.

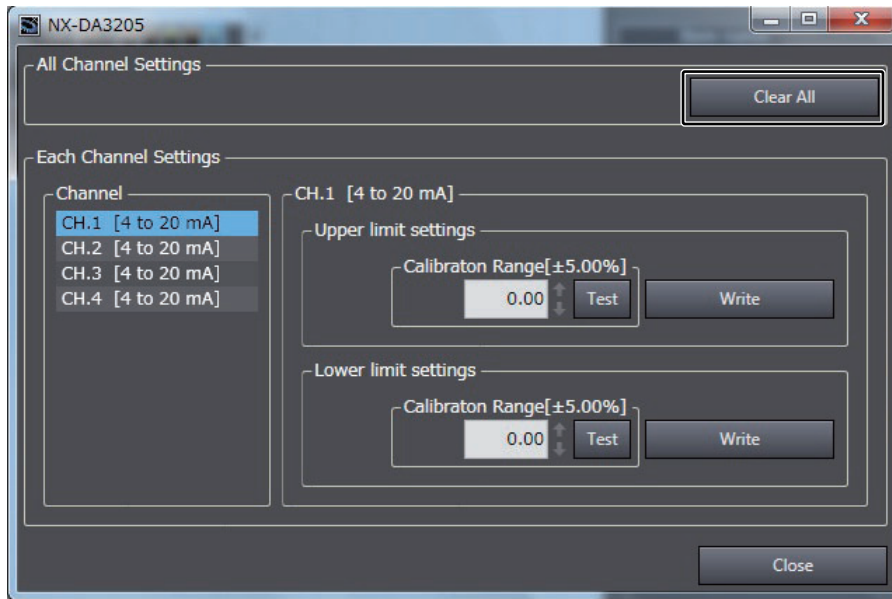

- 3 Click the **Yes** Button on the confirmation message.

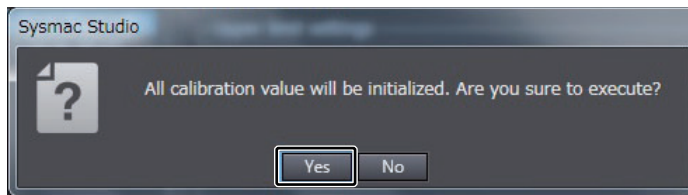

When the writing is completed successfully, the following message is displayed. Click the **OK** Button.

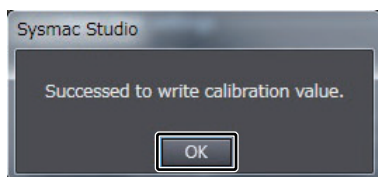

8

Troubleshooting

This section provides error information and corrections for errors that can occur when the Analog Input Units and Analog Output Units are used.

8-1	How to Check for Errors	8-2
8-2	Checking for Errors with the Indicators	8-3
8-3	Checking for Errors and Troubleshooting on the Support Software	8-5
8-3-1	Checking for Errors from the Sysmac Studio	8-5
8-3-2	Checking for Errors from Support Software Other Than the Sysmac Studio ..	8-6
8-3-3	Event Codes and Corrections for Errors	8-7
8-3-4	Meaning of Error	8-13
8-4	Resetting Errors	8-35
8-5	Troubles Specific to Each Type of NX Units	8-36
8-5-1	Troubles Common to All Analog Input Units and Analog Output Units	8-36
8-5-2	Analog Input Units	8-36
8-5-3	Analog Output Units	8-37
8-6	Troubleshooting Flowchart	8-38

8-1 How to Check for Errors

Use one of the following error checking methods.

- Checking the indicators
- Troubleshooting with the Support Software

Refer to the user's manual for the CPU Unit, Communications Coupler Unit, or Communication Control Unit that the NX Units are connected to for details on troubleshooting with the Support Software.

8-2 Checking for Errors with the Indicators

You can use the TS indicators on the NX Units to check the NX Unit status and level of errors.

This section describes the meanings of errors that the TS indicator shows and the troubleshooting procedures for them.

In this section, the status of the indicator is indicated with the following abbreviations.

Abbreviation	Indicator status
Lit	Lit
Not Lit	Not lit
FS ()	Flashing. The numeric value in parentheses is the flashing interval.
---	Undefined

Main Errors and Corrections

The main errors and corrections for the Analog Input Units and Analog Output Units are given in the following table.

TS indicator		Cause	Correction
Green	Red		
Lit	Not Lit	---	--- (This is the normal status.)
FS (2 s)	Not Lit	<ul style="list-style-type: none"> Initializing Downloading 	--- (Normal. Wait until the processing is completed.)
Lit	Lit	This status is not present.	
Not Lit	Not Lit	<p>The Unit power supply is not supplied.</p> <ul style="list-style-type: none"> Waiting for initialization to start Restarting <p>If you cannot resolve the problem after you check the above items and cycle the Slave Terminal power supply, the Unit may have a hardware failure. If this happens, replace the Unit.</p>	<p>Check the following items and supply the Unit power supply correctly.</p> <p>[Check items for power supply]</p> <ul style="list-style-type: none"> Make sure that the power supply cable is wired correctly. Make sure that the power supply cable is not disconnected. Make sure that power supply voltage is within the specified range. Make sure that the power supply has enough capacity. Make sure that power supply has not failed. <p>--- (Normal. Wait until the processing is completed.)</p>
Not Lit	Lit	Hardware failure	If this error occurs after you cycle the Unit power supply, replace the Unit.
Not Lit	Lit	Non-volatile Memory Hardware Error	Refer to Event <i>Non-volatile Memory Hardware Error</i> on page 8-14.
Not Lit	Lit	Analog Unit Calibration Parameter Error	Refer to Event <i>Analog Unit Calibration Parameter Error</i> on page 8-15.

TS indicator		Cause	Correction
Green	Red		
Not Lit	Lit	Control Parameter Error in Master	Refer to Event <i>Control Parameter Error in Master</i> on page 8-16.
Not Lit	Lit	Unit Calibration Value Parity Error	Refer to Event <i>Unit Calibration Value Parity Error</i> on page 8-17.
Not Lit	Lit	NX Unit Clock Not Synchronized Error	Refer to Event <i>NX Unit Clock Not Synchronized Error</i> on page 8-25.
Not Lit	FS (1 s)	NX Unit I/O Communications Error	Refer to Event <i>NX Unit I/O Communications Error</i> on page 8-22.
Not Lit	FS (1 s)	NX Unit Output Synchronization Error	Refer to Event <i>NX Unit Output Synchronization Error</i> on page 8-24.
The indicator status is held immediately before the event occurred.		Unit I/O Disconnection Detected for Channel <input type="checkbox"/>	Refer to Event <i>Unit I/O Disconnection Detected for Channel 1</i> on page 8-17.
		Unit Over Range for Channel <input type="checkbox"/>	Refer to Event <i>Unit Over Range for Channel 1</i> on page 8-26.
		Unit Under Range for Channel <input type="checkbox"/>	Refer to Event <i>Unit Under Range for Channel 1</i> on page 8-30.

8-3 Checking for Errors and Troubleshooting on the Support Software

Error management on the NX Series is based on the methods used for the NJ/NX/NY-series Controllers.

This allows you to use the Support Software to check the meanings of errors and troubleshooting procedures. The confirmation method depends on the Support Software that is used.

8-3-1 Checking for Errors from the Sysmac Studio

When an error occurs, you can place the Sysmac Studio online to the Controller or the Communications Coupler Unit to check current Controller errors and the log of past Controller errors.

Refer to the user's manual for the connected CPU Unit, Communications Coupler Unit, or Communication Control Unit for information on checking errors.

Current Errors

Open the Sysmac Studio's Controller Error Tab Page to check the current error's level, source, source details, event name, event codes, details, attached information 1 to 4, and correction.

Errors in the observation level are not displayed.



Additional Information

Number of Current Errors

The following table gives the number of errors that are reported simultaneously as current errors in each Unit.

Unit	Number of simultaneous error notifications
Analog Input Units Analog Output Units	When these Units are connected to the CPU Unit, since current errors are managed in the CPU Unit, the number of current errors is limited by the number of errors for the CPU Units. For Slave Terminals, since current errors are managed in the Communications Coupler Unit, the number of current errors is limited by the number of errors for the Communications Coupler Unit. When these Units are connected to the Communication Control Unit, since current errors are managed in the Communication Control Unit, the number of current errors is limited by the number of errors for the Communication Control Units.

If the number of errors exceeds the maximum number of reportable current errors, errors are reported with a priority given to the oldest and highest-level errors. Errors that exceed the limit on simultaneous error notifications are not reported.

Errors that are not reported are still reflected in the error status.

Log of Past Errors

Open the Sysmac Studio's Controller Event Log Tab Page to check the times, levels, sources, source details, event names, event codes, details, attached information 1 to 4, and corrections for previous errors.



Additional Information

Number of Logs of Past Errors

Event logs in the Analog I/O Units are stored in the CPU Unit, Communications Coupler Unit, or Communication Control Unit to which they are connected.

Refer to the user's manual for the connected CPU Unit, Communications Coupler Unit, or Communication Control Unit for details on the amount of event logs that are stored in the Unit.

Refer to the troubleshooting manual for the connected CPU Unit or Industrial PC and the *Sysmac Studio Version 1 Operation Manual* (Cat. No. W504) for the items that you can check and the procedures to check for errors.

Refer to *8-3-3 Event Codes and Corrections for Errors* on page 8-7 for details on event codes.

8-3-2 Checking for Errors from Support Software Other Than the Sysmac Studio

You can check the error descriptions and logs with Support Software other than the Sysmac Studio. For the error checking methods, refer to the user's manual for the connected Communications Coupler Unit and the operation manual for the Support Software.

Refer to *8-3-3 Event Codes and Corrections for Errors* on page 8-7 for details on event codes.

The number of current errors and the number of error log errors that occurred in the past in the Analog Input Units or Analog Output Units are the same as for the Sysmac Studio.

8-3-3 Event Codes and Corrections for Errors

The errors (i.e., events) that occur in the Analog Input Units and Analog Output Units are given below.

If your NX Unit is connected to a Communication Control Unit, replace CPU Unit with Communication Control Unit in the descriptions provided for "For the NX bus of CPU Units" in the table below.

The following abbreviations are used in the event level column.

Abbreviation	Name
Maj	Major fault level
Prt	Partial fault level
Min	Minor fault level
Obs	Observation
Info	Information

Symbol	Meaning
S	Event levels that are defined by the system.
U	Event levels that can be changed by the user. *1

*1. This symbol appears only for events for which the user can change the event level.

Refer to the troubleshooting manual for the connected CPU Unit or Industrial PC for information on NJ/NX/NY-series event codes.

Event code	Event name	Meaning	Assumed cause	Level					Reference
				Maj	Prt	Min	Obs	Info	
00200000 hex	Non-volatile Memory Hardware Error	An error occurred in non-volatile memory.	• Non-volatile memory failure			S			P. 8-14
10400000 hex	Analog Unit Calibration Parameter Error	An error occurred for the calibration data in the Analog Unit.	• The power supply to the Analog Unit was turned OFF or Support Software communications were disconnected while writing the calibration values to the Analog Unit.			S			P. 8-15

Event code	Event name	Meaning	Assumed cause	Level					Reference
				Maj	Prt	Min	Obs	Info	
10410000 hex	Control Parameter Error in Master	An error occurred in the control parameters that are saved in the master.	<p>For the NX bus of CPU Units</p> <ul style="list-style-type: none"> The power supply to the CPU Unit was turned OFF while writing the Unit operation settings was in progress. Or there is an error in the area of the non-volatile memory in the CPU Unit in which the Unit operation settings for the relevant NX Unit are saved. <p>For Communications Coupler Units</p> <ul style="list-style-type: none"> The power supply to the Communications Coupler Unit was turned OFF while writing the Unit operation settings was in progress. Or there is an error in the area of the non-volatile memory in the Communications Coupler Unit in which the Unit operation settings for the relevant NX Unit are saved. 			S			P. 8-16
14C00000 hex	Unit Calibration Value Parity Error	An error occurred in the user calibration data in the NX Unit.	<ul style="list-style-type: none"> An error was detected in the calibration data. 			S			P. 8-17
65030000 hex	Unit I/O Disconnection Detected for Channel 1	A disconnected input was detected for channel 1.	<ul style="list-style-type: none"> Input wiring is broken. Input wiring is disconnected. 			S	U		P. 8-17
65040000 hex	Unit I/O Disconnection Detected for Channel 2	A disconnected input was detected for channel 2.	<ul style="list-style-type: none"> Input wiring is broken. Input wiring is disconnected. 			S	U		P. 8-18
65050000 hex	Unit I/O Disconnection Detected for Channel 3	A disconnected input was detected for channel 3.	<ul style="list-style-type: none"> Input wiring is broken. Input wiring is disconnected. 			S	U		P. 8-18
65060000 hex	Unit I/O Disconnection Detected for Channel 4	A disconnected input was detected for channel 4.	<ul style="list-style-type: none"> Input wiring is broken. Input wiring is disconnected. 			S	U		P. 8-19
65070000 hex	Unit I/O Disconnection Detected for Channel 5	A disconnected input was detected for channel 5.	<ul style="list-style-type: none"> Input wiring is broken. Input wiring is disconnected. 			S	U		P. 8-19
65080000 hex	Unit I/O Disconnection Detected for Channel 6	A disconnected input was detected for channel 6.	<ul style="list-style-type: none"> Input wiring is broken. Input wiring is disconnected. 			S	U		P. 8-20
65090000 hex	Unit I/O Disconnection Detected for Channel 7	A disconnected input was detected for channel 7.	<ul style="list-style-type: none"> Input wiring is broken. Input wiring is disconnected. 			S	U		P. 8-20
650A0000 hex	Unit I/O Disconnection Detected for Channel 8	A disconnected input was detected for channel 8.	<ul style="list-style-type: none"> Input wiring is broken. Input wiring is disconnected. 			S	U		P. 8-21

Event code	Event name	Meaning	Assumed cause	Level					Reference
				Maj	Prt	Min	Obs	Info	
80200000 hex	NX Unit I/O Communications Error	An I/O communications error occurred in an NX Unit.	<p>For the NX bus of CPU Units</p> <ul style="list-style-type: none"> An error that prevents normal NX bus communications occurred in a CPU Unit. An NX Unit is not mounted properly. The power cable for the Unit power supply is disconnected, or the wiring from the Unit power supply to the NX Units is incorrect. The power cable for the Unit power supply is broken. The voltage of the Unit power supply is outside the specified range, or the capacity of the Unit power supply is insufficient. There is a hardware error in an NX Unit. <p>For Communications Coupler Units</p> <ul style="list-style-type: none"> An error that prevents normal NX bus communications occurred in a Communications Coupler Unit. The NX Unit is not mounted properly. The power cable for the Unit power supply is disconnected. Or, the wiring from the Unit power supply to the NX Units is incorrect. The power cable for the Unit power supply is broken. The voltage of the Unit power supply is outside the specified range. Or, the capacity of the Unit power supply is insufficient. There is a hardware error in the NX Unit. 			S			P. 8-22
80210000 hex	NX Unit Output Synchronization Error	An output synchronization error occurred in the NX Unit.	<p>For the NX bus of CPU Units</p> <ul style="list-style-type: none"> I/O refreshing on the NX bus is not performed normally due to an error in the CPU Unit. <p>For Communications Coupler Units</p> <ul style="list-style-type: none"> The communications cable connected to the Communications Coupler Unit is broken or the connection is faulty. The communications cable is affected by noise. 			S			P. 8-24

Event code	Event name	Meaning	Assumed cause	Level					Reference
				Maj	Prt	Min	Obs	Info	
80240000 hex	NX Unit Clock Not Synchronized Error	A time information error occurred in an NX Unit.	<p>For the NX bus of CPU Units</p> <ul style="list-style-type: none"> • There is a hardware error in an NX Unit. • There is a hardware error in a CPU Unit. <p>For Communications Coupler Units</p> <ul style="list-style-type: none"> • There is a hardware error in an NX Unit. • There is a hardware error in an EtherCAT Coupler Unit. 			S			P. 8-25
64F00000 hex	Unit Over Range for Channel 1	The analog input data for input channel 1 exceeded the upper limit of the input range. Or, the analog output data for output channel 1 exceeded the upper limit of the output range.	<ul style="list-style-type: none"> • The analog input data exceeded the upper limit of the input range. Or, the analog output data exceeded the upper limit of the output range. 			U	S		P. 8-26
64F10000 hex	Unit Over Range for Channel 2	The analog input data for input channel 2 exceeded the upper limit of the input range. Or, the analog output data for output channel 2 exceeded the upper limit of the output range.	<ul style="list-style-type: none"> • The analog input data exceeded the upper limit of the input range. Or, the analog output data exceeded the upper limit of the output range. 			U	S		P. 8-26
64F20000 hex	Unit Over Range for Channel 3	The analog input data for input channel 3 exceeded the upper limit of the input range. Or, the analog output data for output channel 3 exceeded the upper limit of the output range.	<ul style="list-style-type: none"> • The analog input data exceeded the upper limit of the input range. Or, the analog output data exceeded the upper limit of the output range. 			U	S		P. 8-27
64F30000 hex	Unit Over Range for Channel 4	The analog input data for input channel 4 exceeded the upper limit of the input range. Or, the analog output data for output channel 4 exceeded the upper limit of the output range.	<ul style="list-style-type: none"> • The analog input data exceeded the upper limit of the input range. Or, the analog output data exceeded the upper limit of the output range. 			U	S		P. 8-27
64F40000 hex	Unit Over Range for Channel 5	The analog input data for input channel 5 exceeded the upper limit of the input range. Or, the analog output data for output channel 5 exceeded the upper limit of the output range.	<ul style="list-style-type: none"> • The analog input data exceeded the upper limit of the input range. Or, the analog output data exceeded the upper limit of the output range. 			U	S		P. 8-28

Event code	Event name	Meaning	Assumed cause	Level					Reference
				Maj	Prt	Min	Obs	Info	
64F50000 hex	Unit Over Range for Channel 6	The analog input data for input channel 6 exceeded the upper limit of the input range. Or, the analog output data for output channel 6 exceeded the upper limit of the output range.	<ul style="list-style-type: none"> The analog input data exceeded the upper limit of the input range. Or, the analog output data exceeded the upper limit of the output range. 			U	S		P. 8-28
64F60000 hex	Unit Over Range for Channel 7	The analog input data for input channel 7 exceeded the upper limit of the input range. Or, the analog output data for output channel 7 exceeded the upper limit of the output range.	<ul style="list-style-type: none"> The analog input data exceeded the upper limit of the input range. Or, the analog output data exceeded the upper limit of the output range. 			U	S		P. 8-29
64F70000 hex	Unit Over Range for Channel 8	The analog input data for input channel 8 exceeded the upper limit of the input range. Or, the analog output data for output channel 8 exceeded the upper limit of the output range.	<ul style="list-style-type: none"> The analog input data exceeded the upper limit of the input range. Or, the analog output data exceeded the upper limit of the output range. 			U	S		P. 8-29
64F80000 hex	Unit Under Range for Channel 1	The analog input data for input channel 1 went below the lower limit of the input range. Or, the analog output data for output channel 1 went below the lower limit of the output range.	<ul style="list-style-type: none"> The analog input data went below the lower limit of the input range. Or, the analog output data went below the lower limit of the output range. 			U	S		P. 8-30
64F90000 hex	Unit Under Range for Channel 2	The analog input data for input channel 2 went below the lower limit of the input range. Or, the analog output data for output channel 2 went below the lower limit of the output range.	<ul style="list-style-type: none"> The analog input data went below the lower limit of the input range. Or, the analog output data went below the lower limit of the output range. 			U	S		P. 8-30
64FA0000 hex	Unit Under Range for Channel 3	The analog input data for input channel 3 went below the lower limit of the input range. Or, the analog output data for output channel 3 went below the lower limit of the output range.	<ul style="list-style-type: none"> The analog input data went below the lower limit of the input range. Or, the analog output data went below the lower limit of the output range. 			U	S		P. 8-31

Event code	Event name	Meaning	Assumed cause	Level					Reference
				Maj	Prt	Min	Obs	Info	
64FB0000 hex	Unit Under Range for Channel 4	The analog input data for input channel 4 went below the lower limit of the input range. Or, the analog output data for output channel 4 went below the lower limit of the output range.	<ul style="list-style-type: none"> The analog input data went below the lower limit of the input range. Or, the analog output data went below the lower limit of the output range. 			U	S		P. 8-31
64FC0000 hex	Unit Under Range for Channel 5	The analog input data for input channel 5 went below the lower limit of the input range. Or, the analog output data for output channel 5 went below the lower limit of the output range.	<ul style="list-style-type: none"> The analog input data went below the lower limit of the input range. Or, the analog output data went below the lower limit of the output range. 			U	S		P. 8-32
64FD0000 hex	Unit Under Range for Channel 6	The analog input data for input channel 6 went below the lower limit of the input range. Or, the analog output data for output channel 6 went below the lower limit of the output range.	<ul style="list-style-type: none"> The analog input data went below the lower limit of the input range. Or, the analog output data went below the lower limit of the output range. 			U	S		P. 8-32
64FE0000 hex	Unit Under Range for Channel 7	The analog input data for input channel 7 went below the lower limit of the input range. Or, the analog output data for output channel 7 went below the lower limit of the output range.	<ul style="list-style-type: none"> The analog input data went below the lower limit of the input range. Or, the analog output data went below the lower limit of the output range. 			U	S		P. 8-33
64FF0000 hex	Unit Under Range for Channel 8	The analog input data for input channel 8 went below the lower limit of the input range. Or, the analog output data for output channel 8 went below the lower limit of the output range.	<ul style="list-style-type: none"> The analog input data went below the lower limit of the input range. Or, the analog output data went below the lower limit of the output range. 			U	S		P. 8-33
90400000 hex	Event Log Cleared	The event log was cleared.	<ul style="list-style-type: none"> The event log was cleared by the user. 					S	P. 8-34

8-3-4 Meaning of Error

This section describes the information that is given for individual errors.

If your NX Unit is connected to a Communication Control Unit, replace CPU Unit with Communication Control Unit in the descriptions provided for “For the NX bus of CPU Units” in the tables below.

How to Read Error Descriptions

The items that are used to describe individual errors (events) are described in the following copy of an error table.

Event name	Gives the name of the error.		Event code	Gives the code of the error.	
Meaning	Gives a short description of the error.				
Source	Gives the source of the error.		Source details	Gives details on the source of the error.	Detection timing Tells when the error is detected.
Error attributes	Level	Tells the level of influence on control.*1	Log category	Tells which log the error is saved in.*2	
	Recovery	Gives the recovery method.*3			
Effects	User program	Tells what will happen to execution of the user program.*4	Operation	Provides special information on the operation that results from the error.	
Indicators	Gives the status of the built-in EtherNet/IP port and built-in EtherCAT port indicators. Indicator status is given only for errors in the EtherCAT Master Function Module and the EtherNet/IP Function Module.				
System-defined variables	Variable	Data type	Name		
	Lists the variable names, data types, and meanings for system-defined variables that provide direct error notification, that are directly affected by the error, or that contain settings that cause the error.				
Cause and correction	Assumed cause	Correction	Prevention		
	Lists the possible causes, corrections, and preventive measures for the error.				
Attached information	This is the attached information that is displayed by the Support Software or an HMI.*5,*6				
Precautions/Remarks	Provides precautions, restrictions, and supplemental information. If the user can set the event level, the event levels that can be set, the recovery method, operational information, and other information are also provided.				

*1. One of the following:

- Major fault: Major fault level
- Partial fault: Partial fault level
- Minor fault: Minor fault level
- Observation
- Information

*2. One of the following:

- System: System event log
- Access: Access event log

*3. One of the following:

- Automatic recovery: Normal status is restored automatically when the cause of the error is removed.
- Error reset: Normal status is restored when the error is reset after the cause of the error is removed.
- Cycle the power supply: Normal status is restored when the power supply to the Controller is turned OFF and then back ON after the cause of the error is removed.
- Controller reset: Normal status is restored when the Controller is reset after the cause of the error is removed.
- Depends on cause: The recovery method depends on the cause of the error.

*4. One of the following:

- Continues: Execution of the user program will continue.
- Stops: Execution of the user program stops.
- Starts: Execution of the user program starts.

- *5. "System information" indicates internal system information that is used by OMRON.
- *6. Refer to the appendices of the troubleshooting manual for the connected CPU Unit or Industrial PC for the applicable range of the HMI Troubleshooter.

Error Descriptions

This section describes the information that occurs on the Analog Input Units and Analog Output Units.

Event name	Non-volatile Memory Hardware Error		Event code	00200000 hex	
Meaning	An error occurred in non-volatile memory.				
Source	Depends on where the Support Software is connected and the system configuration.	Source details	NX Unit	Detection timing	When power is turned ON to the NX Unit
Error attributes	Level	Minor fault		Log category	System
	Recovery	<p>For the NX bus of CPU Units Cycle the power supply to the Unit or restart the NX bus.</p> <p>For Communications Coupler Units Cycle the power supply to the Unit or restart the Slave Terminal. If the errors are detected in the Controller, reset all of the errors in the Controller.</p>			
Effects	User program	Continues.	Operation	I/O refreshing for the NX Unit stops. Messages cannot be sent to the NX Unit.	
System-defined variables	Variable	Data type		Name	
	None	---		---	
Cause and correction	Assumed cause	Correction		Prevention	
	Non-volatile memory failure.	<p>For the NX bus of CPU Units Cycle the power supply to the Unit or restart the NX bus. If the error persists even after you make the above correction, replace the relevant NX Unit.</p> <p>For Communications Coupler Units Cycle the power supply to the Unit or restart the Slave Terminal. If the error persists even after you make the above correction, replace the relevant NX Unit.</p>		None	
Attached information	None				
Precautions/Remarks	None				

Event name	Analog Unit Calibration Parameter Error		Event code	10400000 hex	
Meaning	An error occurred for the calibration data in the Analog Unit.				
Source	Depends on where the Support Software is connected and the system configuration.	Source details	NX Unit	Detection timing	When power is turned ON to the NX Unit
Error attributes	Level	Minor fault		Log category	System
	Recovery	<p>For the NX bus of CPU Units</p> <p>When Fail-soft Operation Is Set to <i>Stop</i> Restart the NX Unit and then reset the error in the NX Bus Function Module.</p> <p>When Fail-soft Operation Is Set to <i>Fail-soft</i> Restart the NX Unit.</p> <p>For Communications Coupler Units</p> <p>When Fail-soft Operation Is Set to <i>Stop</i> Restart the NX Unit.</p> <p>If the errors are detected in the Controller, reset all of the errors in the Controller.</p> <p>When Fail-soft Operation Is Set to <i>Fail-soft</i> Restart the NX Unit.</p>			
Effects	User program	Continues.	Operation	I/O refreshing for the NX Unit stops.	
Sys-tem-defined variables	Variable	Data type		Name	
	None	---		---	
Cause and correction	Assumed cause	Correction		Prevention	
	The power supply to the Analog Unit was turned OFF or Support Software communications were disconnected while writing the calibration values to the Analog Unit.	Write the calibration values to the Analog Unit again.		Do not turn OFF the power supply to the Analog Unit or disconnect Support Software communications while writing the calibration values to the Analog Unit.	
Attached information	None				
Precautions/Remarks	None				

Event name	Control Parameter Error in Master		Event code	10410000 hex	
Meaning	An error occurred in the control parameters that are saved in the master.				
Source	Depends on where the Support Software is connected and the system configuration.	Source details	NX Unit		Detection timing When power is turned ON to the NX Unit
Error attributes	Level	Minor fault		Log category	System
	Recovery	<p>For the NX bus of CPU Units</p> <p>When Fail-soft Operation Is Set to <i>Stop</i> Restart the NX Unit and then reset the error in the NX Bus Function Module.</p> <p>When Fail-soft Operation Is Set to <i>Fail-soft</i> Restart the NX Unit and then reset the error in the NX Unit.</p> <p>For Communications Coupler Units</p> <p>When Fail-soft Operation Is Set to <i>Stop</i> If the errors are detected in the Controller, restart the NX Unit and then reset all of the errors in the Controller.</p> <p>If the errors are not detected in the Controller, restart the NX Unit and then reset the error in the Communications Coupler Unit.</p> <p>When Fail-soft Operation Is Set to <i>Fail-soft</i> Restart the NX Unit and then reset the error in the Communications Coupler Unit.</p>			
Effects	User program	Continues.	Operation	I/O refreshing for the NX Unit stops.	
Sys-tem-defined variables	Variable	Data type		Name	
	None	---		---	
Cause and correction	Assumed cause	Correction		Prevention	
	For the NX bus of CPU Units				
	The power supply to the CPU Unit was turned OFF while writing the Unit operation settings was in progress. Or there is an error in the area of the non-volatile memory in the CPU Unit in which the Unit operation settings for the relevant NX Unit are saved.	Download the Unit operation settings of the NX Unit again. If the error persists even after you make the above correction, replace the CPU Unit.		Do not turn OFF the power supply to the CPU Unit while transfer of the Unit operation settings for the NX Unit or save of NX Unit parameters by a message is in progress.	
For Communications Coupler Units					
The power supply to the Communications Coupler Unit was turned OFF while writing the Unit operation settings was in progress. Or there is an error in the area of the non-volatile memory in the Communications Coupler Unit in which the Unit operation settings for the relevant NX Unit are saved.	Download the Unit operation settings of the NX Unit again. If the error occurs again even after you make the above correction, replace the Communications Coupler Unit.		Do not turn OFF the power supply to the Communications Coupler Unit while transfer of the Unit operation settings for the NX Unit by the Support Software or save of NX Unit parameters by a message is in progress.		
Attached information	None				
Precautions/Remarks	None				

Event name	Unit Calibration Value Parity Error		Event code	14C00000 hex	
Meaning	An error occurred in the user calibration data in the NX Unit.				
Source	Depends on where the Support Software is connected and the system configuration.	Source details	NX Unit	Detection timing	Continuously
Error attributes	Level	Minor fault		Log category	System
	Recovery	For the NX bus of CPU Units Restart the NX bus. For Communications Coupler Units Restart the Slave Terminal.			
Effects	User program	Continues.	Operation	The NX Unit will continue to operate. Input data: Updating input values stops. Output data: The output values depend on the Load Rejection Output Setting.	
Sys-tem-defined variables	Variable	Data type		Name	
	None	---		---	
Cause and correction	Assumed cause	Correction		Prevention	
	An error was detected in the calibration data.	Cycle the power supply to the NX Unit. If this error occurs again even after you cycle the power supply, replace the NX Unit.		None	
	None				
Attached information	None				

Event name	Unit I/O Disconnection Detected for Channel 1		Event code	65030000 hex	
Meaning	A disconnected input was detected for channel 1.				
Source	Depends on where the Support Software is connected and the system configuration.	Source details	NX Unit	Detection timing	Continuously
Error attributes	Level	Minor fault		Log category	System
	Recovery	Reset error in the NX Unit.			
Effects	User program	Continues.	Operation	The converted value will be 32,767. Operation continues and the converted value returns to normal when the connection is restored.	
Sys-tem-defined variables	Variable	Data type		Name	
	None	---		---	
Cause and correction	Assumed cause	Correction		Prevention	
	Input wiring is broken.	Check the input wiring for breaks and replace the cable if any are found.		Check the cable for broken wires.	
	Input wiring is disconnected.	Check the input wiring for bad connections and reconnect any bad connections that are found.		Make sure that the wiring is connected properly.	
Attached information	None				
Precautions/Remarks	You can change the event level to the observation level.				

Event name	Unit I/O Disconnection Detected for Channel 2		Event code	65040000 hex	
Meaning	A disconnected input was detected for channel 2.				
Source	Depends on where the Support Software is connected and the system configuration.	Source details	NX Unit	Detection timing	Continuously
Error attributes	Level	Minor fault		Log category	System
	Recovery	Reset error in the NX Unit.			
Effects	User program	Continues.	Operation	The converted value will be 32,767. Operation continues and the converted value returns to normal when the connection is restored.	
	System-defined variables	Variable	Data type	Name	
Cause and correction	Assumed cause	Correction		Prevention	
	Input wiring is broken.	Check the input wiring for breaks and replace the cable if any are found.		Check the cable for broken wires.	
	Input wiring is disconnected.	Check the input wiring for bad connections and reconnect any bad connections that are found.		Make sure that the wiring is connected properly.	
Attached information	None				
Precautions/Remarks	You can change the event level to the observation level.				

Event name	Unit I/O Disconnection Detected for Channel 3		Event code	65050000 hex	
Meaning	A disconnected input was detected for channel 3.				
Source	Depends on where the Support Software is connected and the system configuration.	Source details	NX Unit	Detection timing	Continuously
Error attributes	Level	Minor fault		Log category	System
	Recovery	Reset error in the NX Unit.			
Effects	User program	Continues.	Operation	The converted value will be 32,767. Operation continues and the converted value returns to normal when the connection is restored.	
	System-defined variables	Variable	Data type	Name	
Cause and correction	Assumed cause	Correction		Prevention	
	Input wiring is broken.	Check the input wiring for breaks and replace the cable if any are found.		Check the cable for broken wires.	
	Input wiring is disconnected.	Check the input wiring for bad connections and reconnect any bad connections that are found.		Make sure that the wiring is connected properly.	
Attached information	None				
Precautions/Remarks	You can change the event level to the observation level.				

Event name	Unit I/O Disconnection Detected for Channel 4		Event code	65060000 hex	
Meaning	A disconnected input was detected for channel 4.				
Source	Depends on where the Support Software is connected and the system configuration.	Source details	NX Unit	Detection timing	Continuously
Error attributes	Level	Minor fault		Log category	System
	Recovery	Reset error in the NX Unit.			
Effects	User program	Continues.	Operation	The converted value will be 32,767. Operation continues and the converted value returns to normal when the connection is restored.	
	System-defined variables	Variable	Data type	Name	
Cause and correction	Assumed cause	Correction		Prevention	
	Input wiring is broken.	Check the input wiring for breaks and replace the cable if any are found.		Check the cable for broken wires.	
	Input wiring is disconnected.	Check the input wiring for bad connections and reconnect any bad connections that are found.		Make sure that the wiring is connected properly.	
Attached information	None				
Precautions/Remarks	You can change the event level to the observation level.				

Event name	Unit I/O Disconnection Detected for Channel 5		Event code	65070000 hex	
Meaning	A disconnected input was detected for channel 5.				
Source	Depends on where the Support Software is connected and the system configuration.	Source details	NX Unit	Detection timing	Continuously
Error attributes	Level	Minor fault		Log category	System
	Recovery	Reset error in the NX Unit.			
Effects	User program	Continues.	Operation	The converted value will be 32,767. Operation continues and the converted value returns to normal when the connection is restored.	
	System-defined variables	Variable	Data type	Name	
Cause and correction	Assumed cause	Correction		Prevention	
	Input wiring is broken.	Check the input wiring for breaks and replace the cable if any are found.		Check the cable for broken wires.	
	Input wiring is disconnected.	Check the input wiring for bad connections and reconnect any bad connections that are found.		Make sure that the wiring is connected properly.	
Attached information	None				
Precautions/Remarks	You can change the event level to the observation level.				

Event name	Unit I/O Disconnection Detected for Channel 6		Event code	65080000 hex	
Meaning	A disconnected input was detected for channel 6.				
Source	Depends on where the Support Software is connected and the system configuration.	Source details	NX Unit	Detection timing	Continuously
Error attributes	Level	Minor fault		Log category	System
	Recovery	Reset error in the NX Unit.			
Effects	User program	Continues.	Operation	The converted value will be 32,767. Operation continues and the converted value returns to normal when the connection is restored.	
	System-defined variables	Variable	Data type	Name	
Cause and correction	Assumed cause	Correction		Prevention	
	Input wiring is broken.	Check the input wiring for breaks and replace the cable if any are found.		Check the cable for broken wires.	
	Input wiring is disconnected.	Check the input wiring for bad connections and reconnect any bad connections that are found.		Make sure that the wiring is connected properly.	
Attached information	None				
Precautions/Remarks	You can change the event level to the observation level.				

Event name	Unit I/O Disconnection Detected for Channel 7		Event code	65090000 hex	
Meaning	A disconnected input was detected for channel 7.				
Source	Depends on where the Support Software is connected and the system configuration.	Source details	NX Unit	Detection timing	Continuously
Error attributes	Level	Minor fault		Log category	System
	Recovery	Reset error in the NX Unit.			
Effects	User program	Continues.	Operation	The converted value will be 32,767. Operation continues and the converted value returns to normal when the connection is restored.	
	System-defined variables	Variable	Data type	Name	
Cause and correction	Assumed cause	Correction		Prevention	
	Input wiring is broken.	Check the input wiring for breaks and replace the cable if any are found.		Check the cable for broken wires.	
	Input wiring is disconnected.	Check the input wiring for bad connections and reconnect any bad connections that are found.		Make sure that the wiring is connected properly.	
Attached information	None				
Precautions/Remarks	You can change the event level to the observation level.				

Event name	Unit I/O Disconnection Detected for Channel 8		Event code	650A0000 hex	
Meaning	A disconnected input was detected for channel 8.				
Source	Depends on where the Support Software is connected and the system configuration.	Source details	NX Unit	Detection timing	Continuously
Error attributes	Level	Minor fault		Log category	System
	Recovery	Reset error in the NX Unit.			
Effects	User program	Continues.	Operation	The converted value will be 32,767. Operation continues and the converted value returns to normal when the connection is restored.	
Sys-tem-defined variables	Variable	Data type		Name	
	None	---		---	
Cause and correction	Assumed cause	Correction		Prevention	
	Input wiring is broken.	Check the input wiring for breaks and replace the cable if any are found.		Check the cable for broken wires.	
	Input wiring is disconnected.	Check the input wiring for bad connections and reconnect any bad connections that are found.		Make sure that the wiring is connected properly.	
Attached information	None				
Precautions/Remarks	You can change the event level to the observation level.				

Event name	NX Unit I/O Communications Error		Event code	80200000 hex	
Meaning	An I/O communications error occurred in an NX Unit.				
Source	Depends on where the Support Software is connected and the system configuration.	Source details	NX Unit	Detection timing	Continuously
Error attributes	Level	Minor fault		Log category	System
	Recovery	<p>For the NX bus of CPU Units</p> <p>When Fail-soft Operation Is Set to <i>Stop</i> Reset the error in the NX Bus Function Module.</p> <p>When Fail-soft Operation Is Set to <i>Fail-soft</i> Reset the error in the NX Unit.</p> <p>For Communications Coupler Units</p> <p>When Fail-soft Operation Is Set to <i>Stop</i> If the errors are detected in the Controller, reset all of the errors in the Controller.</p> <p>If the errors are not detected in the Controller, reset errors in the Communications Coupler Unit and NX Unit.</p> <p>When Fail-soft Operation Is Set to <i>Fail-soft</i> Reset errors in the Communications Coupler Unit and NX Unit.</p>			
Effects	User program	Continues.	Operation	<p>The NX Unit will continue to operate.</p> <p>Input data: Updating input values stops.</p> <p>Output data: The output values depend on the Load Rejection Output Setting.</p>	
Sys-tem-defined variables	Variable	Data type		Name	
	None	---		---	

Cause and correction	Assumed cause	Correction	Prevention
	For the NX bus of CPU Units		
	An error that prevents normal NX bus communications occurred in a CPU Unit.	Check the error that occurred in the CPU Unit and perform the required corrections.	Take preventive measures against the error that occurred in the CPU Unit.
	An NX Unit is not mounted properly.	Mount the NX Units and End Cover securely and secure them with End Plates.	Mount the NX Units and End Cover securely and secure them with End Plates.
	The power cable for the Unit power supply is disconnected, or the wiring from the Unit power supply to the NX Units is incorrect.	Wire the Unit power supply to the NX Units securely.	Wire the Unit power supply to the NX Units securely.
	The power cable for the Unit power supply is broken.	If the power cable between the Unit power supply and the NX Units is broken, replace it.	None
	The voltage of the Unit power supply is outside the specified range, or the capacity of the Unit power supply is insufficient.	Configure the power supply system configuration correctly according to the power supply design method.	Configure the power supply system configuration correctly according to the power supply design method.
	There is a hardware error in an NX Unit.	If the error persists even after you make the above correction, replace the NX Unit.	None
	For Communications Coupler Units		
	An error that prevents normal NX bus communications occurred in a Communications Coupler Unit.	Check the error that occurred in the Communications Coupler Unit and perform the required corrections.	Take preventive measures against the error that occurred in the Communications Coupler Unit.
	The NX Unit is not mounted properly.	Mount the NX Units and End Cover securely and secure them with End Plates.	Mount the NX Units and End Cover securely and secure them with End Plates.
	The power cable for the Unit power supply is disconnected. Or, the wiring from the Unit power supply to the NX Units is incorrect.	Correctly wire the Unit power supply to the NX Units.	Correctly wire the Unit power supply to the NX Units.
	The power cable for the Unit power supply is broken.	If the power cable between the Unit power supply and the NX Units is broken, replace it.	None
	The voltage of the Unit power supply is outside the specified range. Or, the capacity of the Unit power supply is insufficient.	Correctly configure the power supply system according to the power supply design methods.	Correctly configure the power supply system according to the power supply design methods.
	There is a hardware error in the NX Unit.	If the error occurs again even after you make the above correction, replace the NX Unit.	None
Attached information	None		
Precautions/Remarks	None		

Event name	NX Unit Output Synchronization Error		Event code	80210000 hex	
Meaning	An output synchronization error occurred in the NX Unit.				
Source	Depends on where the Support Software is connected and the system configuration.	Source details	NX Unit	Detection timing	Continuously
Error attributes	Level	Minor fault		Log category	System
	Recovery	<p>For the NX bus of CPU Units Reset the error in the NX Bus Function Module.</p> <p>For Communications Coupler Units Reset all of the errors in the Controller.</p>			
Effects	User program	Continues.	Operation	<p>The NX Unit will continue to operate.</p> <p>Input data: Updating input values stops.</p> <p>Output data: The output values depend on the Load Rejection Output Setting.</p>	
System-defined variables	Variable	Data type		Name	
	None	---		---	
Cause and correction	Assumed cause	Correction		Prevention	
	For the NX bus of CPU Units				
	I/O refreshing on the NX bus is not performed normally due to an error in the CPU Unit.	Check the error that occurred in the CPU Unit and perform the required corrections.		Take preventive measures against the error that occurred in the CPU Unit.	
	For Communications Coupler Units				
The communications cable connected to the Communications Coupler Unit is broken or the connection is faulty.	Replace the communications cable or wire the cable correctly.		Wire the communications cable correctly.		
The communications cable is affected by noise.	<p>Set the Consecutive Communications Error Detection Count parameter for the Communications Coupler Unit to a suitable value that will not cause problems in operation.</p> <p>Implement noise countermeasures if there is excessive noise.</p>		Implement noise countermeasures. Refer to the operation manuals for the specific Units for noise countermeasures.		
Attached information	None				
Precautions/Remarks	None				

Event name	NX Unit Clock Not Synchronized Error		Event code	8024 0000 hex	
Meaning	A time information error occurred in an NX Unit.				
Source	Depends on where the Support Software is connected and the system configuration.	Source details	NX Unit	Detection timing	Continuously
Error attributes	Level	Minor fault	Log category	System	
	Recovery	For the NX bus of CPU Units Cycle the power supply to the Unit. For Communications Coupler Units Cycle the power supply to the Unit and then reset all of the errors in the Controller.			
Effects	User program	Continues.	Operation	The NX Unit will continue to operate. Input data: Updating input values stops. Output data: The output values depend on the Load Rejection Output Setting.	
Sys-tem-defined variables	Variable	Data type		Name	
	None	---		---	
Cause and correction	Assumed cause	Correction		Prevention	
	For the NX bus of CPU Units				
	There is a hardware error in an NX Unit.	If the error occurs only in a specific NX Unit, replace the relevant NX Unit.		None	
	There is a hardware error in a CPU Unit.	If the error occurs in all of the NX Units mounted on a CPU Unit, replace the CPU Unit.		None	
	For Communications Coupler Units				
	There is a hardware error in an NX Unit.	If the error occurs only in a specific NX Unit, replace the relevant NX Unit.		None	
There is a hardware error in an EtherCAT Coupler Unit.	If the error occurs in all of the NX Units mounted on a Communications Coupler Unit, replace the Communications Coupler Unit.		None		
Attached information	None				
Precautions/Remarks	None				

Event name	Unit Over Range for Channel 1		Event code	64F00000 hex	
Meaning	The analog input data for input channel 1 exceeded the upper limit of the input range. Or, the analog output data for output channel 1 exceeded the upper limit of the output range.				
Source	Depends on where the Support Software is connected and the system configuration.	Source details	NX Unit	Detection timing	Continuously
Error attributes	Level	Observation		Log category	System
	Recovery	Reset error in the NX Unit.			
Effects	User program	Continues.	Operation	If the input range is exceeded, the converted value will be the upper limit of the input range. If the output range is exceeded, the analog output will be the upper limit of the output range.	
System-defined variables	Variable	Data type		Name	
	None	---		---	
Cause and correction	Assumed cause	Correction		Prevention	
	The analog input data exceeded the upper limit of the input range. Or, the analog output data exceeded the upper limit of the output range.	Find the reason for exceeding the upper limit of the input or output range and make suitable corrections.		Find the reasons for exceeding the upper limit of the input or output range and take suitable preventive measures.	
Attached information	None				
Precautions/Remarks	You can change the event level to the minor fault level.				

Event name	Unit Over Range for Channel 2		Event code	64F10000 hex	
Meaning	The analog input data for input channel 2 exceeded the upper limit of the input range. Or, the analog output data for output channel 2 exceeded the upper limit of the output range.				
Source	Depends on where the Support Software is connected and the system configuration.	Source details	NX Unit	Detection timing	Continuously
Error attributes	Level	Observation		Log category	System
	Recovery	Reset error in the NX Unit.			
Effects	User program	Continues.	Operation	If the input range is exceeded, the converted value will be the upper limit of the input range. If the output range is exceeded, the analog output will be the upper limit of the output range.	
System-defined variables	Variable	Data type		Name	
	None	---		---	
Cause and correction	Assumed cause	Correction		Prevention	
	The analog input data exceeded the upper limit of the input range. Or, the analog output data exceeded the upper limit of the output range.	Find the reason for exceeding the upper limit of the input or output range and make suitable corrections.		Find the reasons for exceeding the upper limit of the input or output range and take suitable preventive measures.	
Attached information	None				
Precautions/Remarks	You can change the event level to the minor fault level.				

Event name	Unit Over Range for Channel 3		Event code	64F20000 hex	
Meaning	The analog input data for input channel 3 exceeded the upper limit of the input range. Or, the analog output data for output channel 3 exceeded the upper limit of the output range.				
Source	Depends on where the Support Software is connected and the system configuration.	Source details	NX Unit	Detection timing	Continuously
Error attributes	Level	Observation		Log category	System
	Recovery	Reset error in the NX Unit.			
Effects	User program	Continues.	Operation	If the input range is exceeded, the converted value will be the upper limit of the input range. If the output range is exceeded, the analog output will be the upper limit of the output range.	
	System-defined variables	Variable	Data type	Name	
	None		---	---	
Cause and correction	Assumed cause	Correction	Prevention		
	The analog input data exceeded the upper limit of the input range. Or, the analog output data exceeded the upper limit of the output range.	Find the reason for exceeding the upper limit of the input or output range and make suitable corrections.	Find the reasons for exceeding the upper limit of the input or output range and take suitable preventive measures.		
Attached information	None				
Precautions/Remarks	You can change the event level to the minor fault level.				

Event name	Unit Over Range for Channel 4		Event code	64F30000 hex	
Meaning	The analog input data for input channel 4 exceeded the upper limit of the input range. Or, the analog output data for output channel 4 exceeded the upper limit of the output range.				
Source	Depends on where the Support Software is connected and the system configuration.	Source details	NX Unit	Detection timing	Continuously
Error attributes	Level	Observation		Log category	System
	Recovery	Reset error in the NX Unit.			
Effects	User program	Continues.	Operation	If the input range is exceeded, the converted value will be the upper limit of the input range. If the output range is exceeded, the analog output will be the upper limit of the output range.	
	System-defined variables	Variable	Data type	Name	
	None		---	---	
Cause and correction	Assumed cause	Correction	Prevention		
	The analog input data exceeded the upper limit of the input range. Or, the analog output data exceeded the upper limit of the output range.	Find the reason for exceeding the upper limit of the input or output range and make suitable corrections.	Find the reasons for exceeding the upper limit of the input or output range and take suitable preventive measures.		
Attached information	None				
Precautions/Remarks	You can change the event level to the minor fault level.				

Event name	Unit Over Range for Channel 5		Event code	64F40000 hex	
Meaning	The analog input data for input channel 5 exceeded the upper limit of the input range. Or, the analog output data for output channel 5 exceeded the upper limit of the output range.				
Source	Depends on where the Support Software is connected and the system configuration.	Source details	NX Unit	Detection timing	Continuously
Error attributes	Level	Observation		Log category	System
	Recovery	Reset error in the NX Unit.			
Effects	User program	Continues.	Operation	If the input range is exceeded, the converted value will be the upper limit of the input range. If the output range is exceeded, the analog output will be the upper limit of the output range.	
System-defined variables	Variable	Data type		Name	
	None	---		---	
Cause and correction	Assumed cause	Correction		Prevention	
	The analog input data exceeded the upper limit of the input range. Or, the analog output data exceeded the upper limit of the output range.	Find the reason for exceeding the upper limit of the input or output range and make suitable corrections.		Find the reasons for exceeding the upper limit of the input or output range and take suitable preventive measures.	
Attached information	None				
Precautions/Remarks	You can change the event level to the minor fault level.				

Event name	Unit Over Range for Channel 6		Event code	64F50000 hex	
Meaning	The analog input data for input channel 6 exceeded the upper limit of the input range. Or, the analog output data for output channel 6 exceeded the upper limit of the output range.				
Source	Depends on where the Support Software is connected and the system configuration.	Source details	NX Unit	Detection timing	Continuously
Error attributes	Level	Observation		Log category	System
	Recovery	Reset error in the NX Unit.			
Effects	User program	Continues.	Operation	If the input range is exceeded, the converted value will be the upper limit of the input range. If the output range is exceeded, the analog output will be the upper limit of the output range.	
System-defined variables	Variable	Data type		Name	
	None	---		---	
Cause and correction	Assumed cause	Correction		Prevention	
	The analog input data exceeded the upper limit of the input range. Or, the analog output data exceeded the upper limit of the output range.	Find the reason for exceeding the upper limit of the input or output range and make suitable corrections.		Find the reasons for exceeding the upper limit of the input or output range and take suitable preventive measures.	
Attached information	None				
Precautions/Remarks	You can change the event level to the minor fault level.				

Event name	Unit Over Range for Channel 7		Event code	64F60000 hex	
Meaning	The analog input data for input channel 7 exceeded the upper limit of the input range. Or, the analog output data for output channel 7 exceeded the upper limit of the output range.				
Source	Depends on where the Support Software is connected and the system configuration.	Source details	NX Unit	Detection timing	Continuously
Error attributes	Level	Observation		Log category	System
	Recovery	Reset error in the NX Unit.			
Effects	User program	Continues.	Operation	If the input range is exceeded, the converted value will be the upper limit of the input range. If the output range is exceeded, the analog output will be the upper limit of the output range.	
	System-defined variables	Variable	Data type	Name	
	None		---	---	
Cause and correction	Assumed cause	Correction	Prevention		
	The analog input data exceeded the upper limit of the input range. Or, the analog output data exceeded the upper limit of the output range.	Find the reason for exceeding the upper limit of the input or output range and make suitable corrections.	Find the reasons for exceeding the upper limit of the input or output range and take suitable preventive measures.		
Attached information	None				
Precautions/Remarks	You can change the event level to the minor fault level.				

Event name	Unit Over Range for Channel 8		Event code	64F70000 hex	
Meaning	The analog input data for input channel 8 exceeded the upper limit of the input range. Or, the analog output data for output channel 8 exceeded the upper limit of the output range.				
Source	Depends on where the Support Software is connected and the system configuration.	Source details	NX Unit	Detection timing	Continuously
Error attributes	Level	Observation		Log category	System
	Recovery	Reset error in the NX Unit.			
Effects	User program	Continues.	Operation	If the input range is exceeded, the converted value will be the upper limit of the input range. If the output range is exceeded, the analog output will be the upper limit of the output range.	
	System-defined variables	Variable	Data type	Name	
	None		---	---	
Cause and correction	Assumed cause	Correction	Prevention		
	The analog input data exceeded the upper limit of the input range. Or, the analog output data exceeded the upper limit of the output range.	Find the reason for exceeding the upper limit of the input or output range and make suitable corrections.	Find the reasons for exceeding the upper limit of the input or output range and take suitable preventive measures.		
Attached information	None				
Precautions/Remarks	You can change the event level to the minor fault level.				

Event name	Unit Under Range for Channel 1		Event code	64F80000 hex	
Meaning	The analog input data for input channel 1 went below the lower limit of the input range. Or, the analog output data for output channel 1 went below the lower limit of the output range.				
Source	Depends on where the Support Software is connected and the system configuration.	Source details	NX Unit	Detection timing	Continuously
Error attributes	Level	Observation		Log category	System
	Recovery	Reset error in the NX Unit.			
Effects	User program	Continues.	Operation	If the input data goes below the input range, the converted value will be the lower limit of the input range. If the output data goes below the output range, the analog output will be the lower limit of the output range.	
System-defined variables	Variable	Data type		Name	
	None	---		---	
Cause and correction	Assumed cause	Correction		Prevention	
	The analog input data went below the lower limit of the input range. Or, the analog output data went below the lower limit of the output range.	Find the reason for going below the lower limit of the input or output range and make suitable corrections.		Find the reasons for going below the lower limit of the input or output range and take suitable preventive measures.	
Attached information	None				
Precautions/Remarks	You can change the event level to the minor fault level.				

Event name	Unit Under Range for Channel 2		Event code	64F90000 hex	
Meaning	The analog input data for input channel 2 went below the lower limit of the input range. Or, the analog output data for output channel 2 went below the lower limit of the output range.				
Source	Depends on where the Support Software is connected and the system configuration.	Source details	NX Unit	Detection timing	Continuously
Error attributes	Level	Observation		Log category	System
	Recovery	Reset error in the NX Unit.			
Effects	User program	Continues.	Operation	If the input data goes below the input range, the converted value will be the lower limit of the input range. If the output data goes below the output range, the analog output will be the lower limit of the output range.	
System-defined variables	Variable	Data type		Name	
	None	---		---	
Cause and correction	Assumed cause	Correction		Prevention	
	The analog input data went below the lower limit of the input range. Or, the analog output data went below the lower limit of the output range.	Find the reason for going below the lower limit of the input or output range and make suitable corrections.		Find the reasons for going below the lower limit of the input or output range and take suitable preventive measures.	
Attached information	None				
Precautions/Remarks	You can change the event level to the minor fault level.				

Event name	Unit Under Range for Channel 3		Event code	64FA0000 hex	
Meaning	The analog input data for input channel 3 went below the lower limit of the input range. Or, the analog output data for output channel 3 went below the lower limit of the output range.				
Source	Depends on where the Support Software is connected and the system configuration.	Source details	NX Unit	Detection timing	Continuously
Error attributes	Level	Observation		Log category	System
	Recovery	Reset error in the NX Unit.			
Effects	User program	Continues.	Operation	If the input data goes below the input range, the converted value will be the lower limit of the input range. If the output data goes below the output range, the analog output will be the lower limit of the output range.	
	System-defined variables	Variable	Data type	Name	
	None		---	---	
Cause and correction	Assumed cause		Correction		Prevention
	The analog input data went below the lower limit of the input range. Or, the analog output data went below the lower limit of the output range.		Find the reason for going below the lower limit of the input or output range and make suitable corrections.		Find the reasons for going below the lower limit of the input or output range and take suitable preventive measures.
Attached information	None				
Precautions/Remarks	You can change the event level to the minor fault level.				

Event name	Unit Under Range for Channel 4		Event code	64FB0000 hex	
Meaning	The analog input data for input channel 4 went below the lower limit of the input range. Or, the analog output data for output channel 4 went below the lower limit of the output range.				
Source	Depends on where the Support Software is connected and the system configuration.	Source details	NX Unit	Detection timing	Continuously
Error attributes	Level	Observation		Log category	System
	Recovery	Reset error in the NX Unit.			
Effects	User program	Continues.	Operation	If the input data goes below the input range, the converted value will be the lower limit of the input range. If the output data goes below the output range, the analog output will be the lower limit of the output range.	
	System-defined variables	Variable	Data type	Name	
	None		---	---	
Cause and correction	Assumed cause		Correction		Prevention
	The analog input data went below the lower limit of the input range. Or, the analog output data went below the lower limit of the output range.		Find the reason for going below the lower limit of the input or output range and make suitable corrections.		Find the reasons for going below the lower limit of the input or output range and take suitable preventive measures.
Attached information	None				
Precautions/Remarks	You can change the event level to the minor fault level.				

Event name	Unit Under Range for Channel 5		Event code	64FC0000 hex	
Meaning	The analog input data for input channel 5 went below the lower limit of the input range. Or, the analog output data for output channel 5 went below the lower limit of the output range.				
Source	Depends on where the Support Software is connected and the system configuration.	Source details	NX Unit	Detection timing	Continuously
Error attributes	Level	Observation		Log category	System
	Recovery	Reset error in the NX Unit.			
Effects	User program	Continues.	Operation	If the input data goes below the input range, the converted value will be the lower limit of the input range. If the output data goes below the output range, the analog output will be the lower limit of the output range.	
System-defined variables	Variable	Data type		Name	
	None	---		---	
Cause and correction	Assumed cause	Correction		Prevention	
	The analog input data went below the lower limit of the input range. Or, the analog output data went below the lower limit of the output range.	Find the reason for going below the lower limit of the input or output range and make suitable corrections.		Find the reasons for going below the lower limit of the input or output range and take suitable preventive measures.	
Attached information	None				
Precautions/Remarks	You can change the event level to the minor fault level.				

Event name	Unit Under Range for Channel 6		Event code	64FD0000 hex	
Meaning	The analog input data for input channel 6 went below the lower limit of the input range. Or, the analog output data for output channel 6 went below the lower limit of the output range.				
Source	Depends on where the Support Software is connected and the system configuration.	Source details	NX Unit	Detection timing	Continuously
Error attributes	Level	Observation		Log category	System
	Recovery	Reset error in the NX Unit.			
Effects	User program	Continues.	Operation	If the input data goes below the input range, the converted value will be the lower limit of the input range. If the output data goes below the output range, the analog output will be the lower limit of the output range.	
System-defined variables	Variable	Data type		Name	
	None	---		---	
Cause and correction	Assumed cause	Correction		Prevention	
	The analog input data went below the lower limit of the input range. Or, the analog output data went below the lower limit of the output range.	Find the reason for going below the lower limit of the input or output range and make suitable corrections.		Find the reasons for going below the lower limit of the input or output range and take suitable preventive measures.	
Attached information	None				
Precautions/Remarks	You can change the event level to the minor fault level.				

Event name	Unit Under Range for Channel 7		Event code	64FE0000 hex	
Meaning	The analog input data for input channel 7 went below the lower limit of the input range. Or, the analog output data for output channel 7 went below the lower limit of the output range.				
Source	Depends on where the Support Software is connected and the system configuration.	Source details	NX Unit	Detection timing	Continuously
Error attributes	Level	Observation		Log category	System
	Recovery	Reset error in the NX Unit.			
Effects	User program	Continues.	Operation	If the input data goes below the input range, the converted value will be the lower limit of the input range. If the output data goes below the output range, the analog output will be the lower limit of the output range.	
System-defined variables	Variable	Data type		Name	
	None	---		---	
Cause and correction	Assumed cause	Correction		Prevention	
	The analog input data went below the lower limit of the input range. Or, the analog output data went below the lower limit of the output range.	Find the reason for going below the lower limit of the input or output range and make suitable corrections.		Find the reasons for going below the lower limit of the input or output range and take suitable preventive measures.	
Attached information	None				
Precautions/Remarks	You can change the event level to the minor fault level.				

Event name	Unit Under Range for Channel 8		Event code	64FF0000 hex	
Meaning	The analog input data for input channel 8 went below the lower limit of the input range. Or, the analog output data for output channel 8 went below the lower limit of the output range.				
Source	Depends on where the Support Software is connected and the system configuration.	Source details	NX Unit	Detection timing	Continuously
Error attributes	Level	Observation		Log category	System
	Recovery	Reset error in the NX Unit.			
Effects	User program	Continues.	Operation	If the input data goes below the input range, the converted value will be the lower limit of the input range. If the output data goes below the output range, the analog output will be the lower limit of the output range.	
System-defined variables	Variable	Data type		Name	
	None	---		---	
Cause and correction	Assumed cause	Correction		Prevention	
	The analog input data went below the lower limit of the input range. Or, the analog output data went below the lower limit of the output range.	Find the reason for going below the lower limit of the input or output range and make suitable corrections.		Find the reasons for going below the lower limit of the input or output range and take suitable preventive measures.	
Attached information	None				
Precautions/Remarks	You can change the event level to the minor fault level.				

Event name	Event Log Cleared		Event code	90400000 hex	
Meaning	The event log was cleared.				
Source	Depends on where the Support Software is connected and the system configuration.	Source details	NX Unit	Detection timing	When commanded from user
Error attributes	Level	Information		Log category	Access
	Recovery	---			
Effects	User program	Continues.	Operation	Not affected.	
Sys-tem-defined variables	Variable	Data type		Name	
	None	---		---	
Cause and correction	Assumed cause	Correction		Prevention	
	The event log was cleared by the user.	---		---	
Attached information	Attached information: Events that were cleared 1: The system event log was cleared. 2: The access event log was cleared.				
Precautions/Remarks	None				

8-4 Resetting Errors

Refer to the user's manual for the connected CPU Unit, Communications Coupler Unit, or Communication Control Unit for information on how to reset errors.

8-5 Troubles Specific to Each Type of NX Units

8-5-1 Troubles Common to All Analog Input Units and Analog Output Units

Problem	Assumed cause	Correction
The converted values or analog signal values are different from expected or the error is too large.	The user calibration error is too large.	Execute the user calibration again.
	The required input or output is disabled.	Check to see if the setting is enabled.
	Wiring is incorrect. (Positive and negative are reversed etc.)	Check that the wiring is correct.

8-5-2 Analog Input Units

Problem	Assumed cause	Correction
The disconnection indication does not clear.	The sensor is disconnected.	Restore the sensor connection. Check the connected sensor and input type.
	The input is significantly out of sensor measurement range.	Check that the input is correct.
	Wiring is incorrect. (Positive and negative are reversed etc.)	Check that the wiring is correct.
	The user calibration error is too large.	Execute the user calibration again.
The disconnection detection is not performed.	The disconnection detection cannot be performed with input types other than 4 to 20 mA.	Check the input type.
The user calibration is not accepted.	Attempted to make calibration with inputs outside the correction range.	Input the voltage/current within the correction range from the input device and make the calibration again. If the voltage/current within the correction range cannot be input, change the connecting method to the input device.

8-5-3 Analog Output Units

Problem	Assumed cause	Correction
The expected output is not held when NX bus error or communications errors occur.	The output settings at load rejection are incorrect.	Set the output value at load rejection.
The user calibration is not accepted.	Attempted to make calibration with values outside the correction range.	Set the voltage/current within the correction range and make the calibration again. If the final output values cannot be calibrated within the correctable range, change the connecting method to the output device.
The output is not performed.	The Unit is not wired correctly with the connected external device.	Check the wiring with the connected external device.
	The wiring to the connected external device is disconnected.	Check the wiring with the connected external device.
	A connected external device is defective.	Replace the connected external device.

8-6 Troubleshooting Flowchart

Refer to the user's manual for the connected CPU Unit, Communications Coupler Unit, or Communication Control Unit for details on the standard troubleshooting process when an error occurs.



Inspection and Maintenance

This section describes how to clean, inspect, and maintain the system.

9-1	Cleaning and Inspection	9-2
9-1-1	Cleaning	9-2
9-1-2	Periodic Inspection	9-2
9-2	Maintenance Procedures	9-5

9-1 Cleaning and Inspection

This section describes daily device maintenance such as cleaning and inspection.

Make sure to perform daily or periodic inspections in order to maintain the functions of the Analog Input Units and Analog Output Units in the best operating condition.

9-1-1 Cleaning

Perform the following cleaning procedures periodically to ensure the Analog Input Units and Analog Output Units are maintained in the best operating condition.

- Wipe the equipment over with a soft, dry cloth when performing daily cleaning.
- If dirt remains even after wiping with a soft, dry cloth, wipe with a cloth that has been wet with a sufficiently diluted detergent (2%) and wrung dry.
- Units will become stained if items such as rubber, vinyl products, or adhesive tape are left on the NX Unit for a long period. Remove such items during regular cleaning.



Precautions for Correct Use

- Never use benzene, thinners, other volatile solvents, or chemical cloths.
 - Do not touch the NX bus connectors.
-

9-1-2 Periodic Inspection

NX Units do not have parts with a specific life. However, its elements can deteriorate under improper environmental conditions. Periodic inspections are thus required to ensure that the required conditions are being maintained.

Inspection is recommended at least once every six months to a year, but more frequent inspections may be necessary depending on the severe environments.

Take immediate steps to correct the situation if any of the conditions in the following table are not met.

Periodic Inspection Items

No.	Inspection item	Inspection details	Criteria	Correction
1	External power supply	Is the power supply voltage measured at the terminal block within standards?	Within the power supply voltage range	Use a voltage tester to check the power supply at the terminals. Take necessary steps to bring the power supply within the power supply voltage range.
2	I/O power supply	Is the power supply voltage measured at the I/O terminal block within standards?	Voltages must be within I/O specifications of each NX Unit.	Use a voltage tester to check the power voltage at the terminals. Take necessary steps to bring the I/O power supply within NX Unit standards.
3	Ambient environment	Is the ambient operating temperature within standards?	0 to 55°C	Use a thermometer to check the temperature and ensure that the ambient operating temperature remains within the allowed range of 0 to 55°C.
		Is the ambient operating humidity within standards?	Relative humidity must be 10% to 95% with no condensation.	Use a hygrometer to check the humidity and ensure that the ambient operating humidity remains between 10% and 95%. Make sure that condensation does not occur due to rapid changes in temperature.
		Is it subject to direct sunlight?	Not in direct sunlight	Protect the Controller if necessary.
		Is there an accumulation of dirt, dust, salt, metal powder, etc.?	No accumulation	Clean and protect the Controller if necessary.
		Is there water, oil, or chemical sprays hitting the Controller?	No spray	Clean and protect the Controller if necessary.
		Are there corrosive or flammable gases in the area of the Controller?	No spray	Check by smell or use a sensor.
		Is the Unit subject to shock or vibration?	Vibration resistance and shock resistance must be within specifications.	Install cushioning or other vibration and shock absorbing equipment if necessary.
	Are there noise sources near the Controller?	No significant noise sources	Either separate the Controller and noise source, or protect the Controller.	
4	Installation and wiring	Are the DIN track mounting hooks for each NX Unit securely locked?	No looseness	Securely lock the DIN track mounting hooks.
		Are the cable connectors fully inserted and locked?	No looseness	Correct any improperly installed connectors.
		Are there any loose screws on the End Plates (PFP-M)?	No looseness	Tighten loose screws with a Phillips-head screwdriver.
		Are the NX Units connected to each other along the hookup guides and until they touch the DIN track?	You must connect and fix the NX Units to the DIN track.	Connect the NX Units to each other along the hookup guides and until they touch the DIN track.
		Are there any damaged external wiring cables?	No visible damage	Check visually and replace cables if necessary.

Tools Required for Inspections

● **Required Tools**

- Phillips screwdriver
- Flat-blade screwdriver
- Voltage tester or digital voltmeter
- Industrial alcohol and pure cotton cloth

● **Tools Required Occasionally**

- Oscilloscope
- Thermometer and hygrometer

9-2 Maintenance Procedures

When you replace an Analog Input Unit or Analog Output Unit, follow the procedure in the user's manual for the connected CPU Unit, Communications Coupler Unit, or Communication Control Unit.

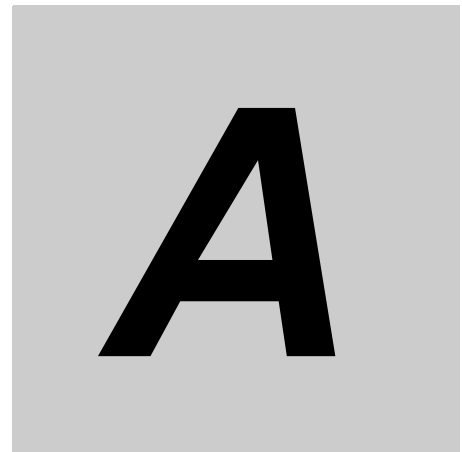

Appendices

The appendices provide the data sheets of the Analog Input Units and Analog Output Units, and the dimensions of the Analog Input Units and Analog Output Units.

A-1 Data Sheet	A-2
A-1-1 Model List	A-2
A-1-2 Analog Input Units	A-4
A-1-3 Analog Output Units	A-24
A-2 Dimensions	A-37
A-2-1 Screwless Clamping Terminal Block Type	A-37
A-3 List of NX Objects	A-39
A-3-1 Format of Object Descriptions	A-39
A-3-2 Analog Input Units	A-40
A-3-3 Analog Output Units	A-49
A-4 List of Screwless Clamping Terminal Block Models	A-54
A-4-1 Model Notation	A-54
A-4-2 List of Terminal Block Models	A-54
A-5 Version Information with CPU Units	A-55
A-5-1 Relationship between Unit Versions of Units	A-55
A-6 Version Information with Communications Coupler Units	A-57
A-6-1 Connection to an EtherCAT Coupler Unit	A-57
A-6-2 Connection to an EtherNet/IP Coupler Unit	A-59
A-7 Version Information with Communication Control Units	A-61
A-7-1 Relationship between Unit Versions of Units	A-61
A-8 Displaying the Edit Unit Operation Settings Tab Page	A-63
A-8-1 Connection to the CPU Unit or the Communication Control Unit	A-63
A-8-2 Slave Terminal	A-65

A-1 Data Sheet

This section provides the specifications of individual Analog Input Units and Analog Output Units.

A-1-1 Model List

Analog Input Units (Screwless Clamping Terminal Block, 12 mm Width)

Model	Number of points	Input range	Resolution	Input method	I/O refreshing method	Conversion time	Reference
NX-AD2203	2 points	4 to 20 mA	1/8000	Single-ended	Free-Run refreshing	250 µs/point	P. A-5
NX-AD2204							
NX-AD2208			1/30000	Differential	Switching Synchronous I/O refreshing and Free-Run refreshing	10 µs/point	P. A-8
NX-AD2603			-10 to +10 V	1/8000	Single-ended	Free-Run refreshing	250 µs/point
NX-AD2604					P. A-10		
NX-AD2608	1/30000	Differential		Switching Synchronous I/O refreshing and Free-Run refreshing	10 µs/point	P. A-11	
NX-AD3203	4 points	4 to 20 mA		1/8000	Single-ended	Free-Run refreshing	250 µs/point
NX-AD3204							
NX-AD3208			1/30000	Differential	Switching Synchronous I/O refreshing and Free-Run refreshing	10 µs/point	P. A-14
NX-AD3603			-10 to +10 V	1/8000	Single-ended	Free-Run refreshing	250 µs/point
NX-AD3604					P. A-16		
NX-AD3608	1/30000	Differential		Switching Synchronous I/O refreshing and Free-Run refreshing	10 µs/point	P. A-17	

Model	Number of points	Input range	Resolution	Input method	I/O refreshing method	Conversion time	Reference
NX-AD4203	8 points	4 to 20 mA	1/8000	Single-ended	Free-Run refreshing	250 µs/point	P. A-18
NX-AD4204							P. A-19
NX-AD4208			1/30000	Differential	Switching Synchronous I/O refreshing and Free-Run refreshing	10 µs/point	P. A-20
NX-AD4603		-10 to +10 V	1/8000	Single-ended	Free-Run refreshing	250 µs/point	P. A-21
NX-AD4604							P. A-22
NX-AD4608			1/30000	Differential	Switching Synchronous I/O refreshing and Free-Run refreshing	10 µs/point	P. A-23

Analog Output Units (Screwless Clamping Terminal Block, 12 mm Width)

Model	Number of points	Output range	Resolution	I/O refreshing method	Conversion time	Reference
NX-DA2203	2 points	4 to 20 mA	1/8000	Free-Run refreshing	250 µs/point	P. A-25
NX-DA2205			1/30000	Switching Synchronous I/O refreshing and Free-Run refreshing	10 µs/point	P. A-27
NX-DA2603		-10 to +10 V	1/8000	Free-Run refreshing	250 µs/point	P. A-29
NX-DA2605			1/30000	Switching Synchronous I/O refreshing and Free-Run refreshing	10 µs/point	P. A-30
NX-DA3203	4 points	4 to 20 mA	1/8000	Free-Run refreshing	250 µs/point	P. A-31
NX-DA3205			1/30000	Switching Synchronous I/O refreshing and Free-Run refreshing	10 µs/point	P. A-33
NX-DA3603		-10 to +10 V	1/8000	Free-Run refreshing	250 µs/point	P. A-35
NX-DA3605			1/30000	Switching Synchronous I/O refreshing and Free-Run refreshing	10 µs/point	P. A-36

A-1-2 Analog Input Units

Description of Items on Data Sheet of the Analog Input Unit

The meanings of the items on the data sheet of the Analog Input Unit are explained in the table below.

Item	Description
Unit name	The name of the Unit.
Model	The model of the Unit.
Number of points	The number of analog input points provided by the Unit.
External connection terminals	The type of terminal block and connector that is used for connecting the Unit. The number of terminals on the terminal block is also described when a screwless clamping terminal block is used.
I/O refreshing method	The I/O refreshing methods that are used by the Unit. Free-Run refreshing and synchronous I/O refreshing are available.
Indicators	The type of indicators on the Unit and the layout of those indicators. *1
Input method	The analog signal input method provided by the Unit. Single-ended input and differential input are available.
Input range	The input range of the Unit.
Input conversion range	The conversion range of converted values for the full scale of the Unit. Input converted values range is fixed to the conversion limit value.
Absolute maximum rating	The maximum value of analog input signals of the Unit. If a signal exceeding this range is input, the Unit may be damaged.
Input impedance	The input impedance of the Unit.
Resolution	The resolution of converted values of the Unit.
Overall accuracy	The analog conversion input accuracy of the Unit. It is defined under the conditions of 25°C and 0 to 55°C.
Conversion time	The time required to convert analog input signals of the Unit to the converted values.
Dimensions	The dimensions of the Unit. They are described as W x H x D. The unit is "mm".
Isolation method	The isolation method between the input circuits and internal circuits and between the input circuits of the Unit.
Insulation resistance	The insulation resistance between the input circuits and internal circuits and between each input circuit of the Unit.
Dielectric strength	The dielectric strength between the input circuits and internal circuits and between each input circuit of the Unit.
I/O power supply method	The method for supplying I/O power for the Unit. The supply method is determined for each Unit. The power is supplied from the NX bus or the external source.
Current capacity of I/O power supply terminal	The current capacity of the I/O power supply terminals (IOV/IOG) of the Unit. Do not exceed this value when supplying the I/O power to the connected external devices.
NX Unit power consumption	The power consumption of the NX Unit power supply of the Unit. The power consumption of the Unit connected to each of the following Units is separately given. If some of the following Units can not be connected to the Unit, relevant information is omitted. <ul style="list-style-type: none"> • CPU Unit • Communications Coupler Unit • Communication Control Unit
Current consumption from I/O power supply	The current consumption from I/O power supply of the Unit. The above input current and current consumption of any connected external devices are excluded.
Weight	The weight of the Unit.
Circuit layout	The input circuit layout of the Unit.
Installation orientation and restrictions	The installation orientation of the Unit. The installation orientation of the Unit connected to each of the following Units is separately given, along with details of the specifications restricted due to the installation orientation, if any. If some of the following Units can not be connected to the Unit, relevant information is omitted. <ul style="list-style-type: none"> • CPU Unit • Communications Coupler Unit • Communication Control Unit

Item	Description
Terminal connection diagram	A diagram of the connection between the Unit and connected external devices. When an I/O Power Supply Connection Unit or a Shield Connection Unit is required to be connected to the connected external devices, the description for such is included.
Input disconnection detection	The function of the Unit to detect an input disconnection. This function is provided for models with the 4 to 20 mA input range.

*1. The layout of the indicators after the appearance change is shown for models released in or before September 2018. For details on the applicable models and the changes, refer to 3-2-2 *Appearance Change of the Indicators* on page 3-8.

Analog Input Units (Screwless Clamping Terminal Block, 12 mm Width)

Unit name	Analog Input Unit (current input type)	Model	NX-AD2203	
Number of points	2 points	External connection terminals	Screwless clamping terminal block (8 terminals)	
I/O refreshing method	Free-Run refreshing			
Indicators	TS indicator 	Input method	Single-ended input	
		Input range	4 to 20 mA	
		Input conversion range	-5 to 105% (full scale)	
		Absolute maximum rating	±30 mA	
		Input impedance	250 Ω	
		Resolution	1/8000 (full scale)	
		Overall accuracy	25 °C	±0.2% (full scale)
			0 to 55°C	±0.4% (full scale)
Conversion time	250 μs/point			
Dimensions	12 (W) x 100 (H) x 71 (D)	Isolation method	Between the input and the NX bus: Power = Transformer, Signal = Digital isolator (no isolation between inputs)	
Insulation resistance	20 MΩ min. between isolated circuits (at 100 VDC)	Dielectric strength	510 VAC between isolated circuits for 1 minute at a leakage current of 5 mA max.	
I/O power supply method	Supply from the NX bus	Current capacity of I/O power supply terminal	I/OV: 0.1 A/terminal max., IOG: 0.1 A/terminal max.	
NX Unit power consumption	<ul style="list-style-type: none"> Connected to a CPU Unit or Communication Control Unit 1.25 W max. Connected to a Communications Coupler Unit 0.90 W max. 	Current consumption from I/O power supply	No consumption	
Weight	70 g max.			

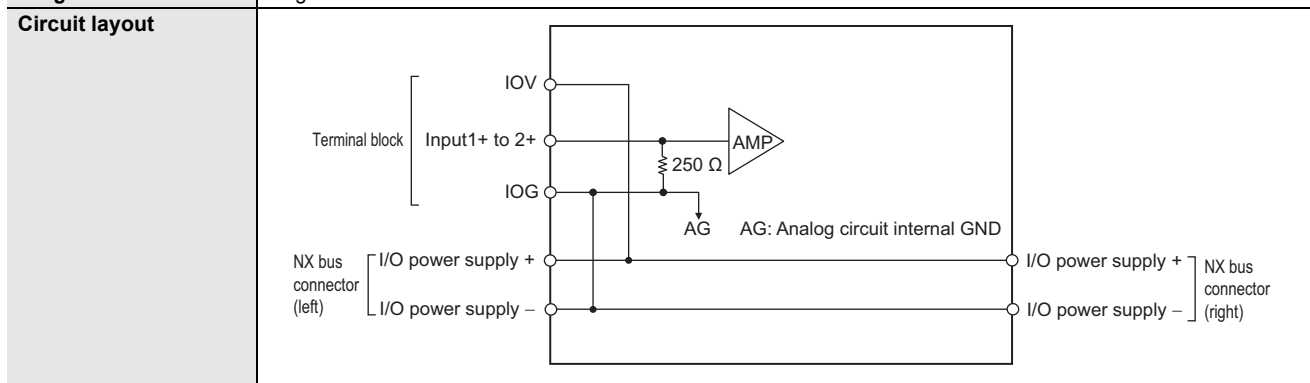

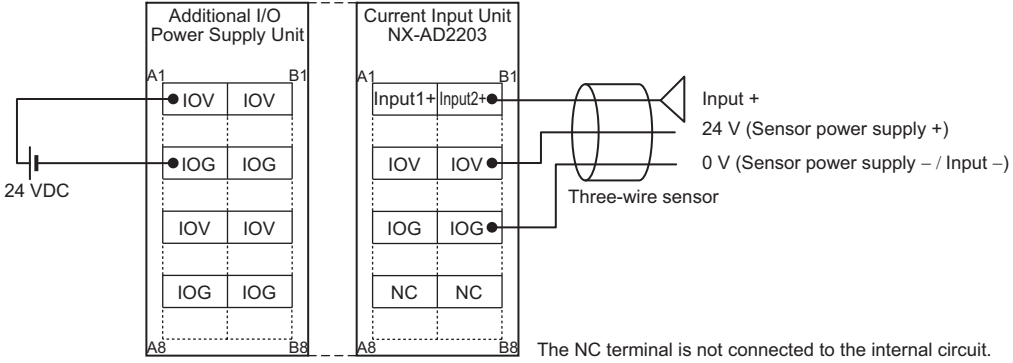

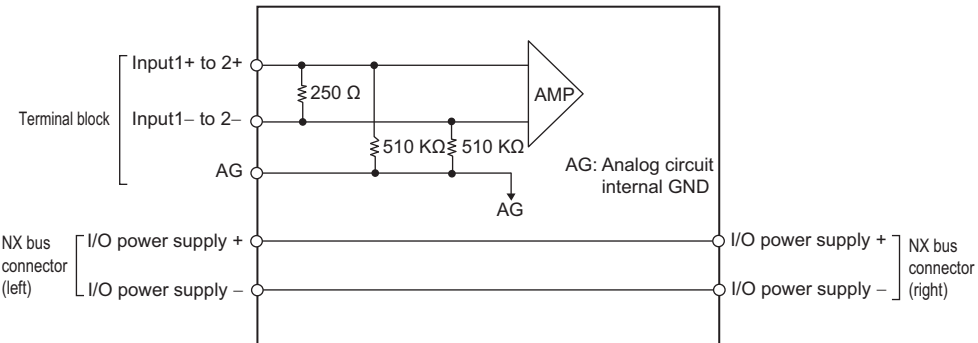
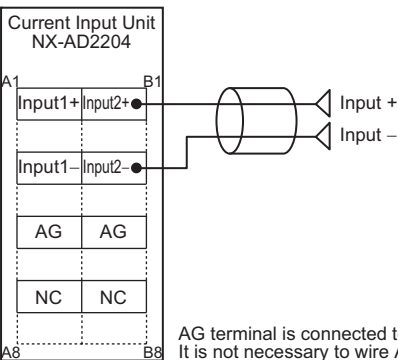
<p>Installation orientation and restrictions</p>	<p>Installation orientation:</p> <ul style="list-style-type: none"> • Connected to a CPU Unit or Communication Control Unit Possible in upright installation. • Connected to a Communications Coupler Unit Possible in 6 orientations. <p>Restrictions: No restrictions</p>
<p>Terminal connection diagram</p>	 <p>The NC terminal is not connected to the internal circuit.</p>
<p>Input disconnection detection</p>	<p>Supported</p>

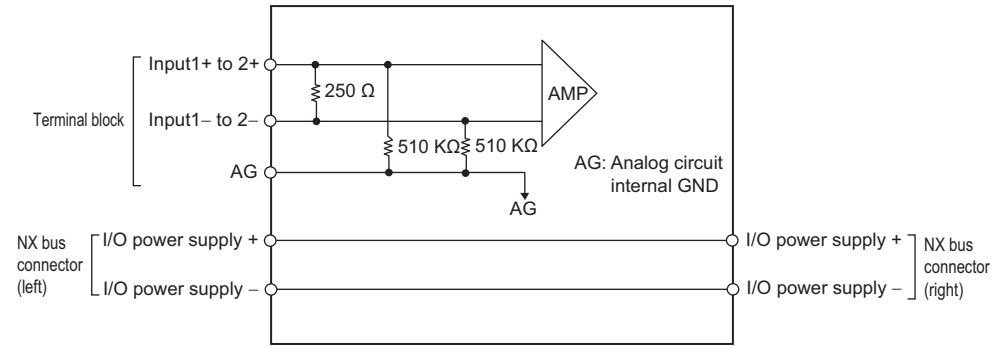
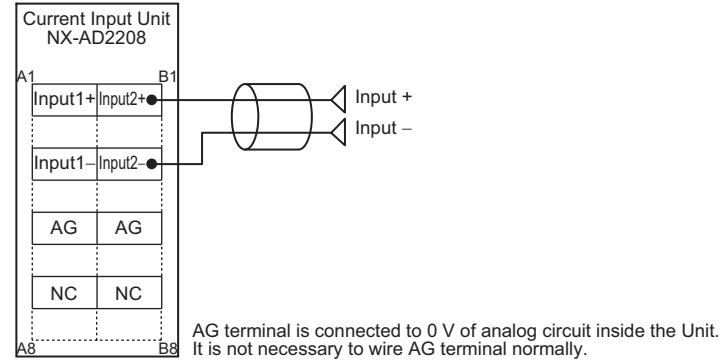
Unit name	Analog Input Unit (current input type)	Model	NX-AD2204				
Number of points	2 points	External connection terminals	Screwless clamping terminal block (8 terminals)				
I/O refreshing method	Free-Run refreshing						
Indicators		Input method	Differential input				
		Input range	4 to 20 mA				
		Input conversion range	-5 to 105% (full-scale)				
		Absolute maximum rating	±30 mA				
		Input impedance	250 Ω				
		Resolution	1/8000 (full scale)				
		Overall accuracy	<table border="1"> <tr> <td>25°C</td> <td>±0.2% (full scale)</td> </tr> <tr> <td>0 to 55°C</td> <td>±0.4% (full scale)</td> </tr> </table>	25°C	±0.2% (full scale)	0 to 55°C	±0.4% (full scale)
		25°C	±0.2% (full scale)				
0 to 55°C	±0.4% (full scale)						
Conversion time	250 μs/point						
Dimensions	12 (W) x 100 (H) x 71 (D)	Isolation method	Between the input and the NX bus: Power = Transformer, Signal = Digital isolator (no isolation between inputs)				
Insulation resistance	20 MΩ min. between isolated circuits (at 100 VDC)	Dielectric strength	510 VAC between isolated circuits for 1 minute at a leakage current of 5 mA max.				
I/O power supply method	No supply	Current capacity of I/O power supply terminal	Without I/O power supply terminals				
NX Unit power consumption	<ul style="list-style-type: none"> Connected to a CPU Unit or Communication Control Unit 1.25 W max. Connected to a Communications Coupler Unit 0.90 W max. 	Current consumption from I/O power supply	No consumption				
Weight	70 g max.						
Circuit layout							
Installation orientation and restrictions	<p>Installation orientation:</p> <ul style="list-style-type: none"> Connected to a CPU Unit or Communication Control Unit Possible in upright installation. Connected to a Communications Coupler Unit Possible in 6 orientations. <p>Restrictions: No restrictions</p>						
Terminal connection diagram	 <p>AG terminal is connected to 0 V of analog circuit inside the Unit. It is not necessary to wire AG terminal normally.</p>						
Input disconnection detection	Supported						

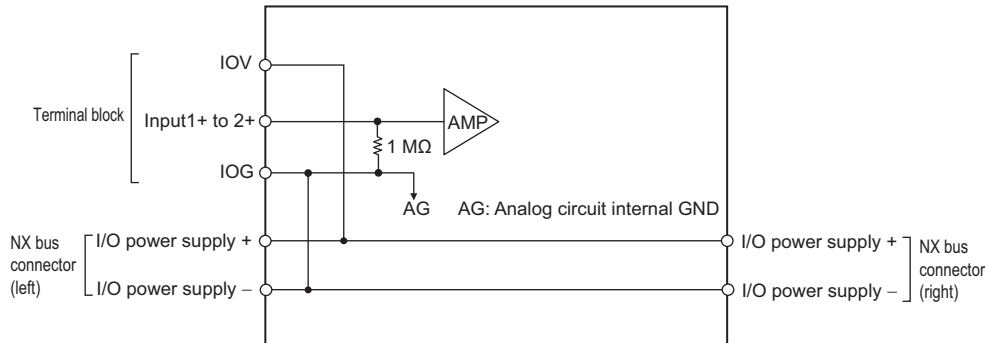
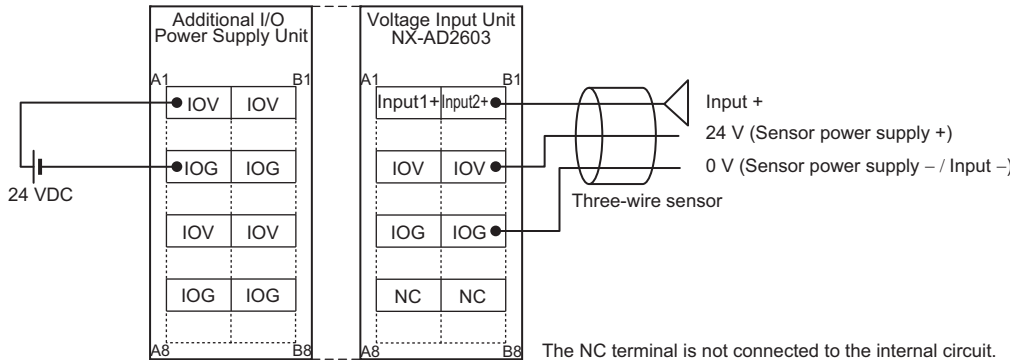
Unit name	Analog Input Unit (current input type)	Model	NX-AD2208	
Number of points	2 points	External connection terminals	Screwless clamping terminal block (8 terminals)	
I/O refreshing method	Switching synchronous I/O refreshing and Free-Run refreshing			
Indicators		Input method	Differential input	
		Input range	4 to 20 mA	
		Input conversion range	-5 to 105% (full scale)	
		Absolute maximum rating	±30 mA	
		Input impedance	250 Ω	
		Resolution	1/30000 (full scale)	
		Overall accuracy	25°C	±0.1% (full scale)
			0 to 55°C	±0.2% (full scale)
Conversion time	10 μs/point			
Dimensions	12 (W) x 100 (H) x 71 (D)	Isolation method	Between the input and the NX bus: Power = Transformer, Signal = Digital isolator (no isolation between inputs)	
Insulation resistance	20 MΩ min. between isolated circuits (at 100 VDC)	Dielectric strength	510 VAC between isolated circuits for 1 minute at a leakage current of 5 mA max.	
I/O power supply method	No supply	Current capacity of I/O power supply terminal	Without I/O power supply terminals	
NX Unit power consumption	<ul style="list-style-type: none"> Connected to a CPU Unit or Communication Control Unit 1.25 W max. Connected to a Communications Coupler Unit 0.90 W max. 	Current consumption from I/O power supply	No consumption	
Weight	70 g max.			
Circuit layout				
Installation orientation and restrictions	<p>Installation orientation:</p> <ul style="list-style-type: none"> Connected to a CPU Unit or Communication Control Unit Possible in upright installation. Connected to a Communications Coupler Unit Possible in 6 orientations. <p>Restrictions: No restrictions</p>			
Terminal connection diagram	 <p>AG terminal is connected to 0 V of analog circuit inside the Unit. It is not necessary to wire AG terminal normally.</p>			
Input disconnection detection	Supported			

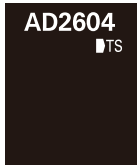
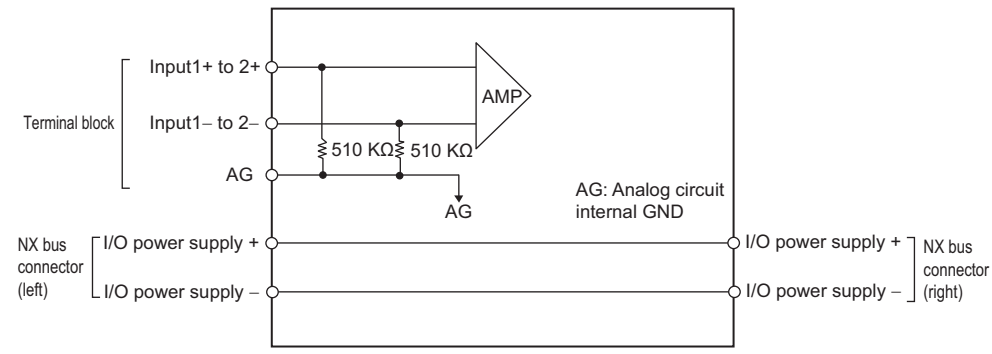
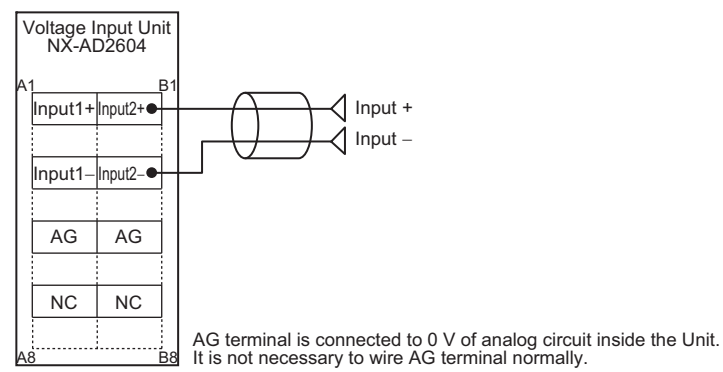
Unit name	Analog Input Unit (voltage input type)	Model	NX-AD2603	
Number of points	2 points	External connection terminals	Screwless clamping terminal block (8 terminals)	
I/O refreshing method	Free-Run refreshing			
Indicators	TS indicator 	Input method	Single-ended input	
		Input range	-10 to +10 V	
		Input conversion range	-5 to 105% (full scale)	
		Absolute maximum rating	±15 V	
		Input impedance	1 MΩ min.	
		Resolution	1/8000 (full scale)	
		Overall accuracy	25°C	±0.2% (full scale)
			0 to 55°C	±0.4% (full scale)
Conversion time	250 μs/point			
Dimensions	12 (W) x 100 (H) x 71 (D)	Isolation method	Between the input and the NX bus: Power = Transformer, Signal = Digital isolator (no isolation between inputs)	
Insulation resistance	20 MΩ min. between isolated circuits (at 100 VDC)	Dielectric strength	510 VAC between isolated circuits for 1 minute at a leakage current of 5 mA max.	
I/O power supply method	Supply from the NX bus	Current capacity of I/O power supply terminal	IOV: 0.1 A/terminal max., IOG: 0.1 A/terminal max.	
NX Unit power consumption	<ul style="list-style-type: none"> Connected to a CPU Unit or Communication Control Unit 1.35 W max. Connected to a Communications Coupler Unit 1.05 W max. 	Current consumption from I/O power supply	No consumption	
Weight	70 g max.			
Circuit layout				
Installation orientation and restrictions	Installation orientation: <ul style="list-style-type: none"> Connected to a CPU Unit or Communication Control Unit Possible in upright installation. Connected to a Communications Coupler Unit Possible in 6 orientations. Restrictions: No restrictions			
Terminal connection diagram	 <p>The NC terminal is not connected to the internal circuit.</p>			
Input disconnection detection	Not supported.			

Unit name	Analog Input Unit (voltage input type)	Model	NX-AD2604	
Number of points	2 points	External connection terminals	Screwless clamping terminal block (8 terminals)	
I/O refreshing method	Free-Run refreshing			
Indicators	TS indicator 	Input method	Differential input	
		Input range	-10 to +10 V	
		Input conversion range	-5 to 105% (full scale)	
		Absolute maximum rating	±15 V	
		Input impedance	1 MΩ min.	
		Resolution	1/8000 (full scale)	
		Overall accuracy	25°C	±0.2% (full scale)
			0 to 55°C	±0.4% (full scale)
Conversion time	250 μs/point			
Dimensions	12 (W) x 100 (H) x 71 (D)	Isolation method	Between the input and the NX bus: Power = Transformer, Signal = Digital isolator (no isolation between inputs)	
Insulation resistance	20 MΩ min. between isolated circuits (at 100 VDC)	Dielectric strength	510 VAC between isolated circuits for 1 minute at a leakage current of 5 mA max.	
I/O power supply method	No supply	Current capacity of I/O power supply terminal	Without I/O power supply terminals	
NX Unit power consumption	<ul style="list-style-type: none"> Connected to a CPU Unit or Communication Control Unit 1.35 W max. Connected to a Communications Coupler Unit 1.05 W max. 	Current consumption from I/O power supply	No consumption	
Weight	70 g max.			
Circuit layout				
Installation orientation and restrictions	Installation orientation: <ul style="list-style-type: none"> Connected to a CPU Unit or Communication Control Unit Possible in upright installation. Connected to a Communications Coupler Unit Possible in 6 orientations. Restrictions: No restrictions			
Terminal connection diagram	 <p>AG terminal is connected to 0 V of analog circuit inside the Unit. It is not necessary to wire AG terminal normally.</p>			
Input disconnection detection	Not supported.			

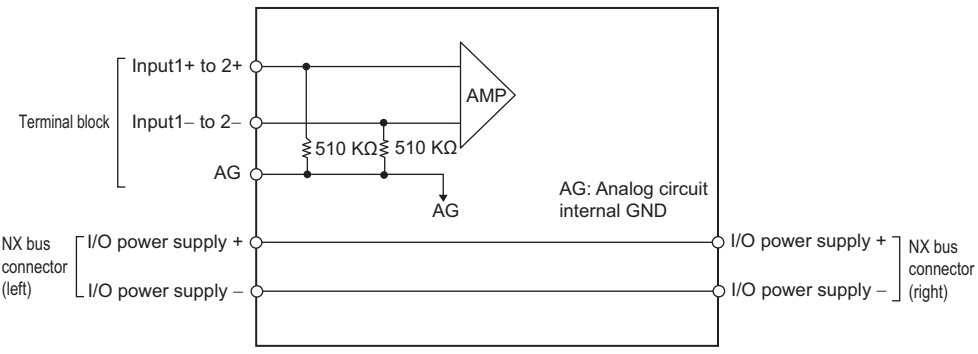
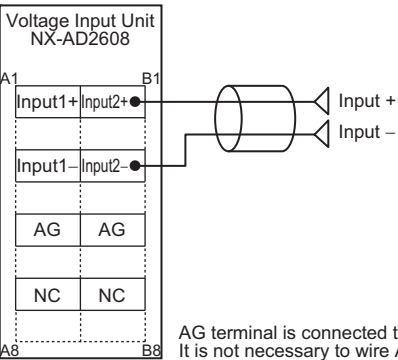
Unit name	Analog Input Unit (voltage input type)	Model	NX-AD2608	
Number of points	2 points	External connection terminals	Screwless clamping terminal block (8 terminals)	
I/O refreshing method	Switching synchronous I/O refreshing and Free-Run refreshing			
Indicators		Input method	Differential input	
		Input range	-10 to +10 V	
		Input conversion range	-5 to 105% (full scale)	
		Absolute maximum rating	±15 V	
		Input impedance	1 MΩ min.	
		Resolution	1/30000 (full scale)	
		Overall accuracy	25°C	±0.1% (full scale)
			0 to 55°C	±0.2% (full scale)
		Conversion time	10 μs/point	
Dimensions	12 (W) x 100 (H) x 71 (D)	Isolation method	Between the input and the NX bus: Power = Transformer, Signal = Digital isolator (no isolation between inputs)	
Insulation resistance	20 MΩ min. between isolated circuits (at 100 VDC)	Dielectric strength	510 VAC between isolated circuits for 1 minute at a leakage current of 5 mA max.	
I/O power supply method	No supply	Current capacity of I/O power supply terminal	Without I/O power supply terminals	
NX Unit power consumption	<ul style="list-style-type: none"> Connected to a CPU Unit or Communication Control Unit 1.35 W max. Connected to a Communications Coupler Unit 1.05 W max. 	Current consumption from I/O power supply	No consumption	
Weight	70 g max.			
Circuit layout				
Installation orientation and restrictions	<p>Installation orientation:</p> <ul style="list-style-type: none"> Connected to a CPU Unit or Communication Control Unit Possible in upright installation. Connected to a Communications Coupler Unit Possible in 6 orientations. <p>Restrictions: No restrictions</p>			
Terminal connection diagram	 <p>AG terminal is connected to 0 V of analog circuit inside the Unit. It is not necessary to wire AG terminal normally.</p>			
Input disconnection detection	Not supported.			

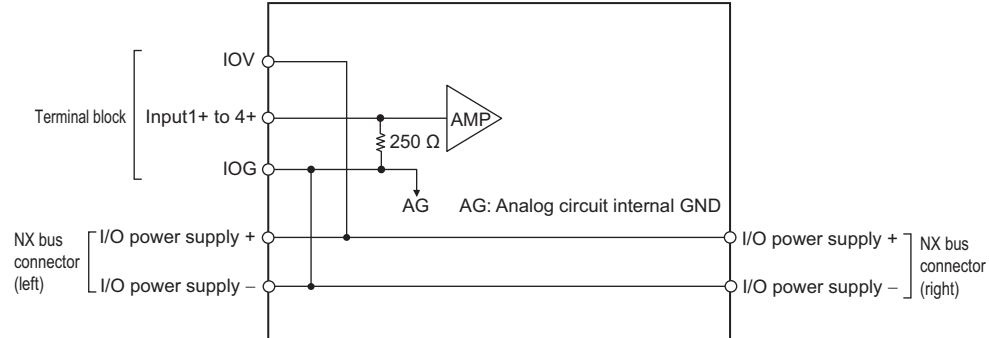
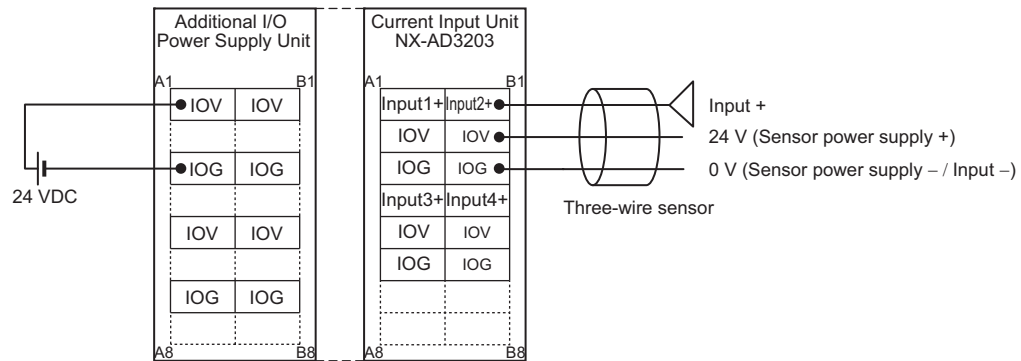
Unit name	Analog Input Unit (current input type)	Model	NX-AD3203	
Number of points	4 points	External connection terminals	Screwless clamping terminal block (12 terminals)	
I/O refreshing method	Free-Run refreshing			
Indicators	TS indicator 	Input method	Single-ended input	
		Input range	4 to 20 mA	
		Input conversion range	-5 to 105% (full scale)	
		Absolute maximum rating	±30 mA	
		Input impedance	250 Ω	
		Resolution	1/8000 (full scale)	
		Overall accuracy	25°C	±0.2% (full scale)
			0 to 55°C	±0.4% (full scale)
Conversion time	250 μs/point			
Dimensions	12 (W) x 100 (H) x 71 (D)	Isolation method	Between the input and the NX bus: Power = Transformer, Signal = Digital isolator (no isolation between inputs)	
Insulation resistance	20 MΩ min. between isolated circuits (at 100 VDC)	Dielectric strength	510 VAC between isolated circuits for 1 minute at a leakage current of 5 mA max.	
I/O power supply method	Supply from the NX bus	Current capacity of I/O power supply terminal	IOV: 0.1 A/terminal max., IOG: 0.1 A/terminal max.	
NX Unit power consumption	<ul style="list-style-type: none"> Connected to a CPU Unit or Communication Control Unit 1.25 W max. Connected to a Communications Coupler Unit 0.90 W max. 	Current consumption from I/O power supply	No consumption	
Weight	70 g max.			
Circuit layout				
Installation orientation and restrictions	<p>Installation orientation:</p> <ul style="list-style-type: none"> Connected to a CPU Unit or Communication Control Unit Possible in upright installation. Connected to a Communications Coupler Unit Possible in 6 orientations. <p>Restrictions: No restrictions</p>			
Terminal connection diagram				
Input disconnection detection	Supported			

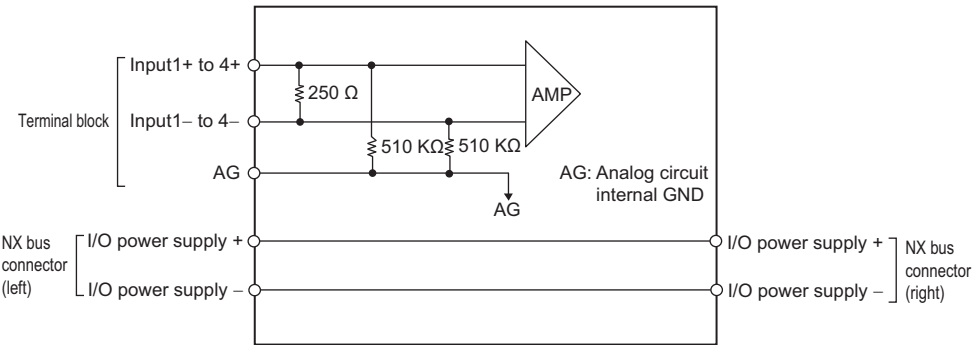
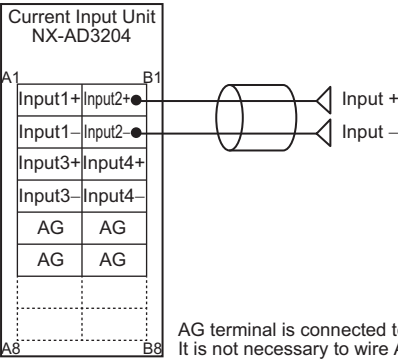
Unit name	Analog Input Unit (current input type)	Model	NX-AD3204	
Number of points	4 points	External connection terminals	Screwless clamping terminal block (12 terminals)	
I/O refreshing method	Free-Run refreshing			
Indicators	TS indicator 	Input method	Differential input	
		Input range	4 to 20 mA	
		Input conversion range	-5 to 105% (full scale)	
		Absolute maximum rating	±30 mA	
		Input impedance	250 Ω	
		Resolution	1/8000 (full scale)	
		Overall accuracy	25°C	±0.2% (full scale)
			0 to 55°C	±0.4% (full scale)
		Conversion time	250 μs/point	
Dimensions	12 (W) x 100 (H) x 71 (D)	Isolation method	Between the input and the NX bus: Power = Transformer, Signal = Digital isolator (no isolation between inputs)	
Insulation resistance	20 MΩ min. between isolated circuits (at 100 VDC)	Dielectric strength	510 VAC between isolated circuits for 1 minute at a leakage current of 5 mA max.	
I/O power supply method	No supply	Current capacity of I/O power supply terminal	Without I/O power supply terminals	
NX Unit power consumption	<ul style="list-style-type: none"> Connected to a CPU Unit or Communication Control Unit 1.25 W max. Connected to a Communications Coupler Unit 0.90 W max. 	Current consumption from I/O power supply	No consumption	
Weight	70 g max.			
Circuit layout				
Installation orientation and restrictions	Installation orientation: <ul style="list-style-type: none"> Connected to a CPU Unit or Communication Control Unit Possible in upright installation. Connected to a Communications Coupler Unit Possible in 6 orientations. Restrictions: No restrictions			
Terminal connection diagram	 <p>AG terminal is connected to 0 V of analog circuit inside the Unit. It is not necessary to wire AG terminal normally.</p>			
Input disconnection detection	Supported			

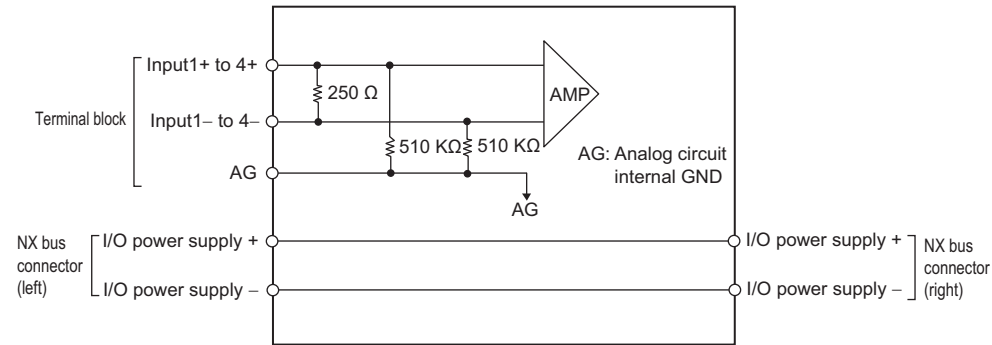
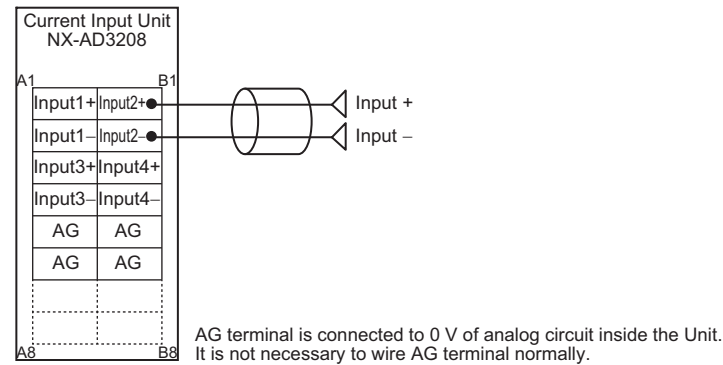
Unit name	Analog Input Unit (current input type)	Model	NX-AD3208	
Number of points	4 points	External connection terminals	Screwless clamping terminal block (12 terminals)	
I/O refreshing method	Switching synchronous I/O refreshing and Free-Run refreshing			
Indicators	TS indicator 	Input method	Differential input	
		Input range	4 to 20 mA	
		Input conversion range	-5 to 105% (full scale)	
		Absolute maximum rating	±30 mA	
		Input impedance	250 Ω	
		Resolution	1/30000 (full scale)	
		Overall accuracy	25°C	±0.1% (full scale)
			0 to 55°C	±0.2% (full scale)
Conversion time	10 μs/point			
Dimensions	12 (W) x 100 (H) x 71 (D)	Isolation method	Between the input and the NX bus: Power = Transformer, Signal = Digital isolator (no isolation between inputs)	
Insulation resistance	20 MΩ min. between isolated circuits (at 100 VDC)	Dielectric strength	510 VAC between isolated circuits for 1 minute at a leakage current of 5 mA max.	
I/O power supply method	No supply	Current capacity of I/O power supply terminal	Without I/O power supply terminals	
NX Unit power consumption	<ul style="list-style-type: none"> Connected to a CPU Unit or Communication Control Unit 1.30 W max. Connected to a Communications Coupler Unit 0.95 W max. 	Current consumption from I/O power supply	No consumption	
Weight	70 g max.			
Circuit layout				
Installation orientation and restrictions	Installation orientation: <ul style="list-style-type: none"> Connected to a CPU Unit or Communication Control Unit Possible in upright installation. Connected to a Communications Coupler Unit Possible in 6 orientations. Restrictions: No restrictions			
Terminal connection diagram	 <p>AG terminal is connected to 0 V of analog circuit inside the Unit. It is not necessary to wire AG terminal normally.</p>			
Input disconnection detection	Supported			

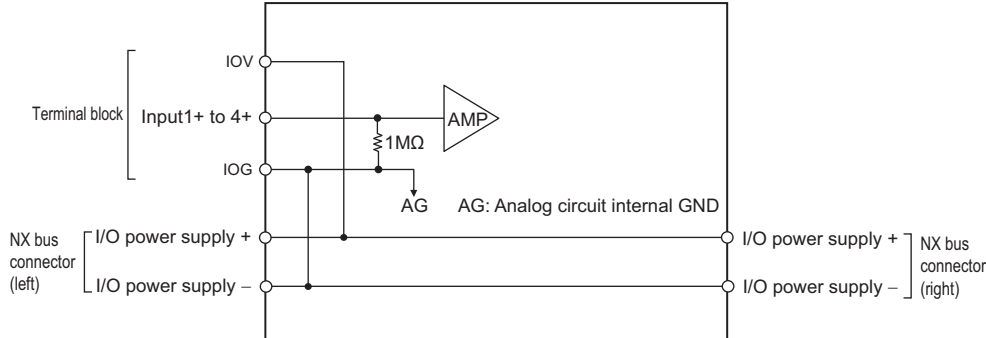
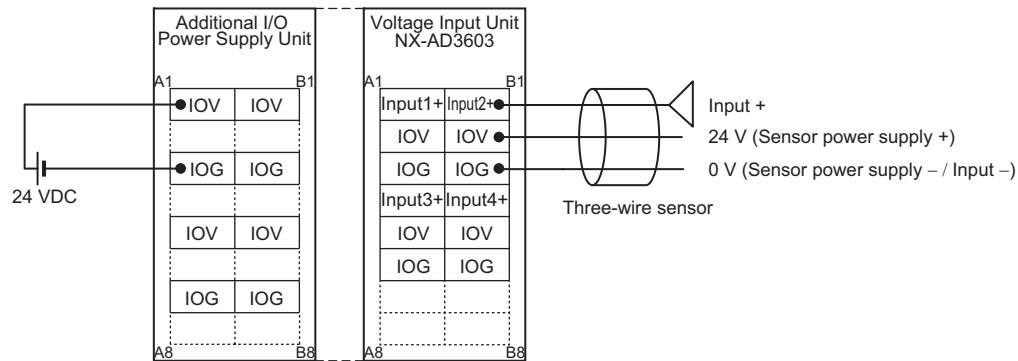
Unit name	Analog Input Unit (voltage input type)	Model	NX-AD3603	
Number of points	4 points	External connection terminals	Screwless clamping terminal block (12 terminals)	
I/O refreshing method	Free-Run refreshing			
Indicators		Input method	Single-ended input	
		Input range	-10 to +10 V	
		Input conversion range	-5 to 105% (full scale)	
		Absolute maximum rating	±15 V	
		Input impedance	1 MΩ min.	
		Resolution	1/8000 (full scale)	
		Overall accuracy	25°C	±0.2% (full scale)
			0 to 55°C	±0.4% (full scale)
Conversion time	250 μs/point			
Dimensions	12 (W) x 100 (H) x 71 (D)	Isolation method	Between the input and the NX bus: Power = Transformer, Signal = Digital isolator (no isolation between inputs)	
Insulation resistance	20 MΩ min. between isolated circuits (at 100 VDC)	Dielectric strength	510 VAC between isolated circuits for 1 minute at a leakage current of 5 mA max.	
I/O power supply method	Supply from the NX bus	Current capacity of I/O power supply terminal	IOV: 0.1 A/terminal max., IOG: 0.1 A/terminal max.	
NX Unit power consumption	<ul style="list-style-type: none"> Connected to a CPU Unit or Communication Control Unit 1.35 W max. Connected to a Communications Coupler Unit 1.10 W max. 	Current consumption from I/O power supply	No consumption	
Weight	70 g max.			
Circuit layout				
Installation orientation and restrictions	<p>Installation orientation:</p> <ul style="list-style-type: none"> Connected to a CPU Unit or Communication Control Unit Possible in upright installation. Connected to a Communications Coupler Unit Possible in 6 orientations. <p>Restrictions: No restrictions</p>			
Terminal connection diagram				
Input disconnection detection	Not supported.			

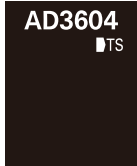
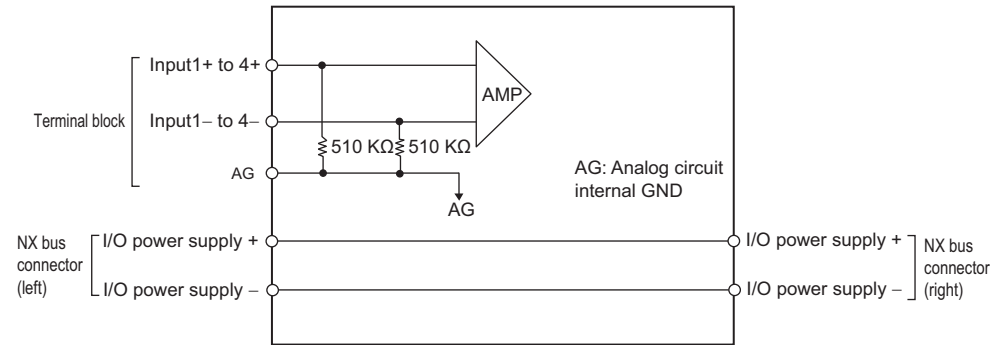
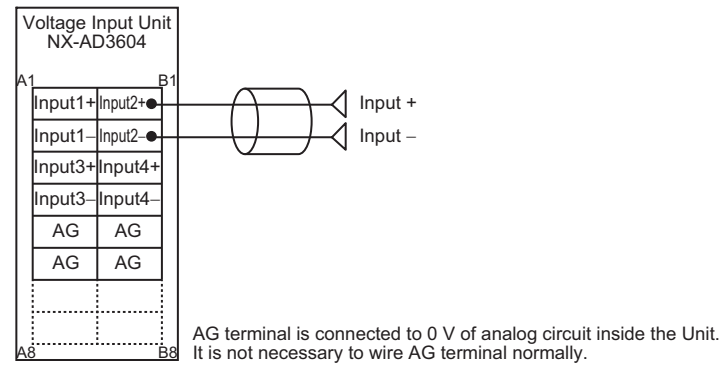
Unit name	Analog Input Unit (voltage input type)	Model	NX-AD3604	
Number of points	4 points	External connection terminals	Screwless clamping terminal block (12 terminals)	
I/O refreshing method	Free-Run refreshing			
Indicators	TS indicator 	Input method	Differential input	
		Input range	-10 to +10 V	
		Input conversion range	-5 to 105% (full scale)	
		Absolute maximum rating	±15 V	
		Input impedance	1 MΩ min.	
		Resolution	1/8000 (full scale)	
		Overall accuracy	25°C	±0.2% (full scale)
			0 to 55°C	±0.4% (full scale)
Conversion time	250 μs/point			
Dimensions	12 (W) x 100 (H) x 71 (D)	Isolation method	Between the input and the NX bus: Power = Transformer, Signal = Digital isolator (no isolation between inputs)	
Insulation resistance	20 MΩ min. between isolated circuits (at 100 VDC)	Dielectric strength	510 VAC between isolated circuits for 1 minute at a leakage current of 5 mA max.	
I/O power supply method	No supply	Current capacity of I/O power supply terminal	Without I/O power supply terminals	
NX Unit power consumption	<ul style="list-style-type: none"> Connected to a CPU Unit or Communication Control Unit 1.35 W max. Connected to a Communications Coupler Unit 1.10 W max. 	Current consumption from I/O power supply	No consumption	
Weight	70 g max.			
Circuit layout				
Installation orientation and restrictions	Installation orientation: <ul style="list-style-type: none"> Connected to a CPU Unit or Communication Control Unit Possible in upright installation. Connected to a Communications Coupler Unit Possible in 6 orientations. Restrictions: No restrictions			
Terminal connection diagram	 <p>AG terminal is connected to 0 V of analog circuit inside the Unit. It is not necessary to wire AG terminal normally.</p>			
Input disconnection detection	Not supported.			

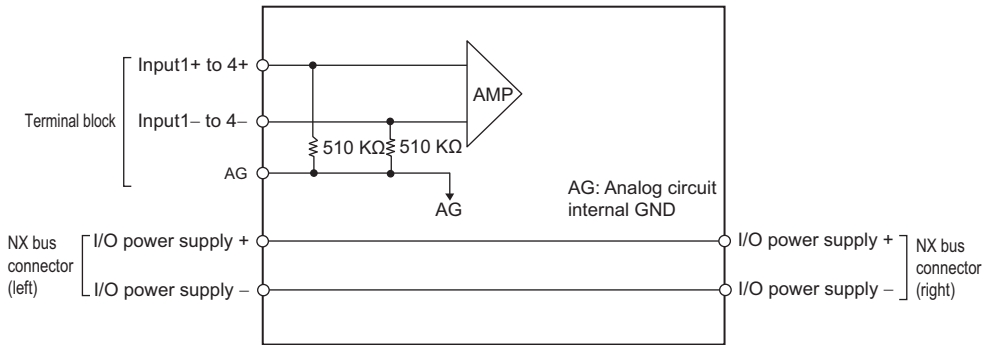
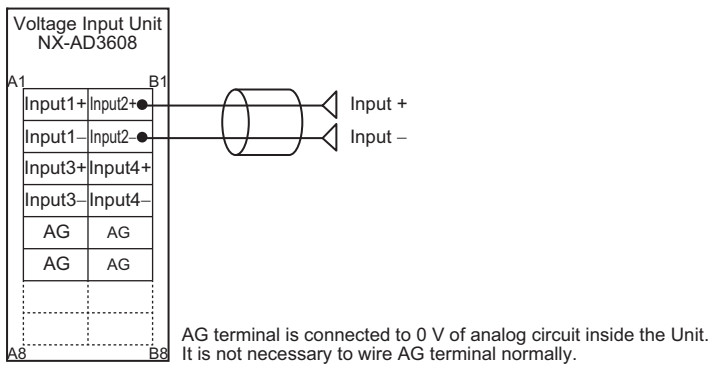
Unit name	Analog Input Unit (voltage input type)	Model	NX-AD3608	
Number of points	4 points	External connection terminals	Screwless clamping terminal block (12 terminals)	
I/O refreshing method	Switching synchronous I/O refreshing and Free-Run refreshing			
Indicators		Input method	Differential input	
		Input range	-10 to +10 V	
		Input conversion range	-5 to 105% (full scale)	
		Absolute maximum rating	±15 V	
		Input impedance	1 MΩ min.	
		Resolution	1/30000 (full scale)	
		Overall accuracy	25°C	±0.1% (full scale)
			0 to 55°C	±0.2% (full scale)
		Conversion time	10 μs/point	
Dimensions	12 (W) x 100 (H) x 71 (D)	Isolation method	Between the input and the NX bus: Power = Transformer, Signal = Digital isolator (no isolation between inputs)	
Insulation resistance	20 MΩ min. between isolated circuits (at 100 VDC)	Dielectric strength	510 VAC between isolated circuits for 1 minute at a leakage current of 5 mA max.	
I/O power supply method	No supply	Current capacity of I/O power supply terminal	Without I/O power supply terminals	
NX Unit power consumption	<ul style="list-style-type: none"> Connected to a CPU Unit or Communication Control Unit 1.45 W max. Connected to a Communications Coupler Unit 1.10 W max. 	Current consumption from I/O power supply	No consumption	
Weight	70 g max.			
Circuit layout				
Installation orientation and restrictions	<p>Installation orientation:</p> <ul style="list-style-type: none"> Connected to a CPU Unit or Communication Control Unit Possible in upright installation. Connected to a Communications Coupler Unit Possible in 6 orientations. <p>Restrictions: No restrictions</p>			
Terminal connection diagram	 <p>AG terminal is connected to 0 V of analog circuit inside the Unit. It is not necessary to wire AG terminal normally.</p>			
Input disconnection detection	Not supported.			

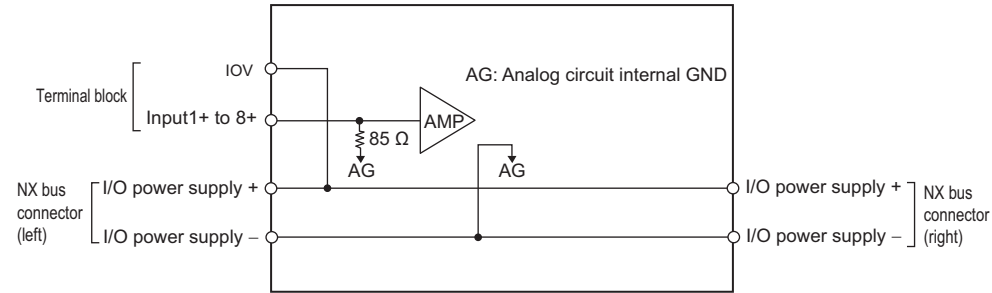
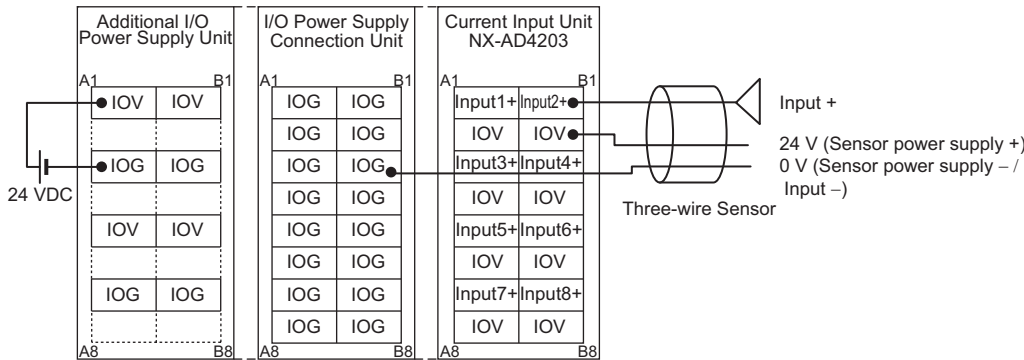
Unit name	Analog Input Unit (current input type)	Model	NX-AD4203	
Number of points	8 points	External connection terminals	Screwless clamping terminal block (16 terminals)	
I/O refreshing method	Free-Run refreshing			
Indicators	TS indicator 	Input method	Single-ended input	
		Input range	4 to 20 mA	
		Input conversion range	-5 to 105% (full scale)	
		Absolute maximum rating	±30 mA	
		Input impedance	85 Ω	
		Resolution	1/8000 (full scale)	
		Overall accuracy	25°C	±0.2% (full scale)
			0 to 55°C	±0.4% (full scale)
Conversion time	250 μs/point			
Dimensions	12 (W) x 100 (H) x 71 (D)	Isolation method	Between the input and the NX bus: Power = Transformer, Signal = Digital isolator (no isolation between inputs)	
Insulation resistance	20 MΩ min. between isolated circuits (at 100 VDC)	Dielectric strength	510 VAC between isolated circuits for 1 minute at a leakage current of 5 mA max.	
I/O power supply method	Supply from the NX bus	Current capacity of I/O power supply terminal	IOV: 0.1 A/terminal max.	
NX Unit power consumption	<ul style="list-style-type: none"> Connected to a CPU Unit or Communication Control Unit 1.40 W max. Connected to a Communications Coupler Unit 1.05 W max. 	Current consumption from I/O power supply	No consumption	
Weight	70 g max.			
Circuit layout				
Installation orientation and restrictions	Installation orientation: <ul style="list-style-type: none"> Connected to a CPU Unit or Communication Control Unit Possible in upright installation. Connected to a Communications Coupler Unit Possible in 6 orientations. Restrictions: No restrictions			
Terminal connection diagram				
Input disconnection detection	Supported			

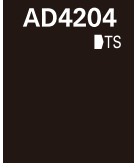
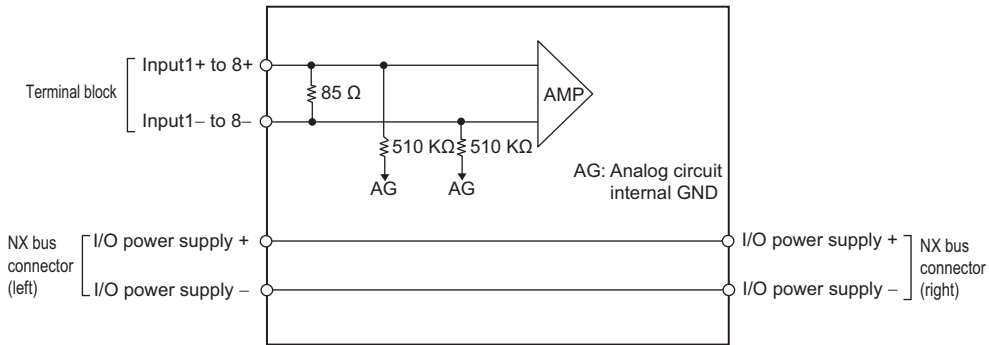
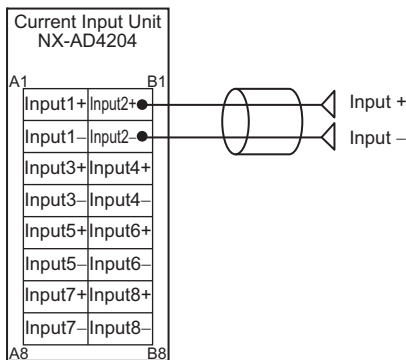
Unit name	Analog Input Unit (current input type)	Model	NX-AD4204	
Number of points	8 points	External connection terminals	Screwless clamping terminal block (16 terminals)	
I/O refreshing method	Free-Run refreshing			
Indicators	TS indicator 	Input method	Differential input	
		Input range	4 to 20 mA	
		Input conversion range	-5 to 105% (full scale)	
		Absolute maximum rating	±30 mA	
		Input impedance	85 Ω	
		Resolution	1/8000 (full scale)	
		Overall accuracy	25°C	±0.2% (full scale)
			0 to 55°C~	±0.4% (full scale)
Conversion time	250 μs/point			
Dimensions	12 (W) x 100 (H) x 71 (D)	Isolation method	Between the input and the NX bus: Power = Transformer, Signal = Digital isolator (no isolation between inputs)	
Insulation resistance	20 MΩ min. between isolated circuits (at 100 VDC)	Dielectric strength	510 VAC between isolated circuits for 1 minute at a leakage current of 5 mA max.	
I/O power supply method	No supply	Current capacity of I/O power supply terminal	Without I/O power supply terminals	
NX Unit power consumption	<ul style="list-style-type: none"> Connected to a CPU Unit or Communication Control Unit 1.40 W max. Connected to a Communications Coupler Unit 1.05 W max. 	Current consumption from I/O power supply	No consumption	
Weight	70 g max.			
Circuit layout				
Installation orientation and restrictions	Installation orientation: <ul style="list-style-type: none"> Connected to a CPU Unit or Communication Control Unit Possible in upright installation. Connected to a Communications Coupler Unit Possible in 6 orientations. Restrictions: No restrictions			
Terminal connection diagram				
Input disconnection detection	Supported			

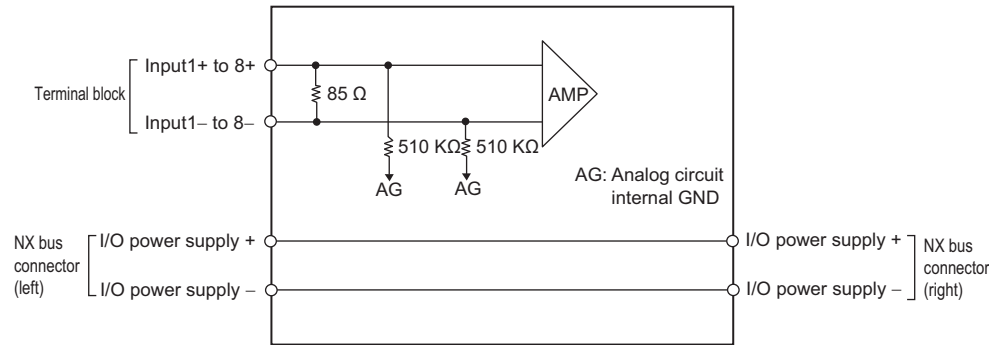
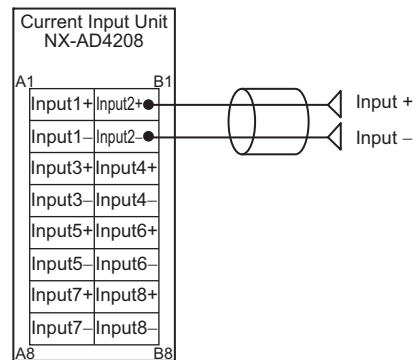
Unit name	Analog Input Unit (current input type)	Model	NX-AD4208	
Number of points	8 points	External connection terminals	Screwless clamping terminal block (16 terminals)	
I/O refreshing method	Switching synchronous I/O refreshing and Free-Run refreshing			
Indicators	TS indicator 	Input method	Differential input	
		Input range	4 to 20 mA	
		Input conversion range	-5 to 105% (full scale)	
		Absolute maximum rating	±30 mA	
		Input impedance	85 Ω	
		Resolution	1/30000 (full scale)	
		Overall accuracy	25°C	±0.1% (full scale)
			0 to 55°C	±0.2% (full scale)
Conversion time	10 μs/point			
Dimensions	12 (W) x 100 (H) x 71 (D)	Isolation method	Between the input and the NX bus: Power = Transformer, Signal = Digital isolator (no isolation between inputs)	
Insulation resistance	20 MΩ min. between isolated circuits (at 100 VDC)	Dielectric strength	510 VAC between isolated circuits for 1 minute at a leakage current of 5 mA max.	
I/O power supply method	No supply	Current capacity of I/O power supply terminal	Without I/O power supply terminals	
NX Unit power consumption	<ul style="list-style-type: none"> Connected to a CPU Unit or Communication Control Unit 1.45 W max. Connected to a Communications Coupler Unit 1.10 W max. 	Current consumption from I/O power supply	No consumption	
Weight	70 g max.			
Circuit layout				
Installation orientation and restrictions	Installation orientation: <ul style="list-style-type: none"> Connected to a CPU Unit or Communication Control Unit Possible in upright installation. Connected to a Communications Coupler Unit Possible in 6 orientations. Restrictions: No restrictions			
Terminal connection diagram				
Input disconnection detection	Supported			

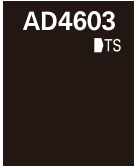
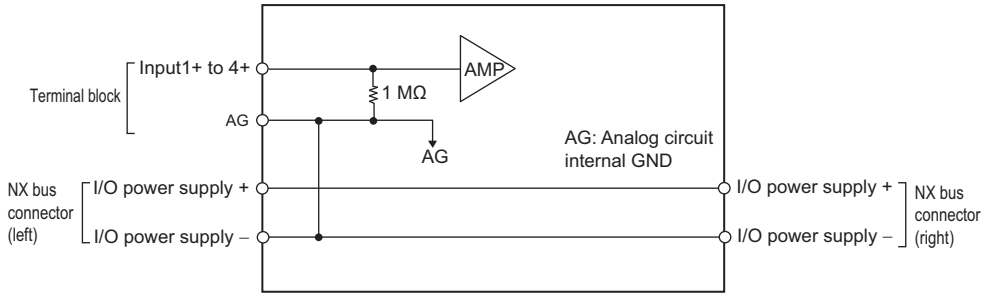
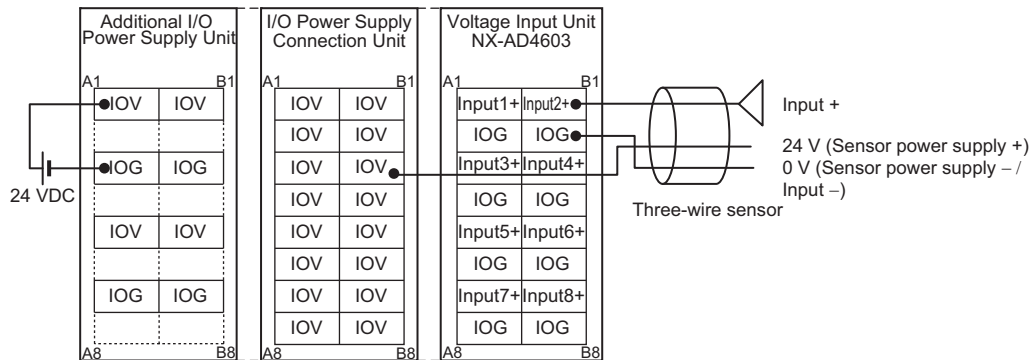
Unit name	Analog Input Unit (voltage input type)	Model	NX-AD4603	
Number of points	8 points	External connection terminals	Screwless clamping terminal block (16 terminals)	
I/O refreshing method	Free-Run refreshing			
Indicators		Input method	Single-ended input	
		Input range	-10 to +10 V	
		Input conversion range	-5 to 105% (full scale)	
		Absolute maximum rating	±15 V	
		Input impedance	1 MΩ min.	
		Resolution	1/8000 (full scale)	
		Overall accuracy	25°C	±0.2% (full scale)
			0 to 55°C	±0.4% (full scale)
Conversion time	250 μs/point			
Dimensions	12 (W) x 100 (H) x 71 (D)	Isolation method	Between the input and the NX bus: Power = Transformer, Signal = Digital isolator (no isolation between inputs)	
Insulation resistance	20 MΩ min. between isolated circuits (at 100 VDC)	Dielectric strength	510 VAC between isolated circuits for 1 minute at a leakage current of 5 mA max.	
I/O power supply method	Supply from the NX bus	Current capacity of I/O power supply terminal	I/OG: 0.1 A/terminal max.	
NX Unit power consumption	<ul style="list-style-type: none"> Connected to a CPU Unit or Communication Control Unit 1.45 W max. Connected to a Communications Coupler Unit 1.15 W max. 	Current consumption from I/O power supply	No consumption	
Weight	70 g max.			
Circuit layout				
Installation orientation and restrictions	<p>Installation orientation:</p> <ul style="list-style-type: none"> Connected to a CPU Unit or Communication Control Unit Possible in upright installation. Connected to a Communications Coupler Unit Possible in 6 orientations. <p>Restrictions: No restrictions</p>			
Terminal connection diagram				
Input disconnection detection	Not supported.			

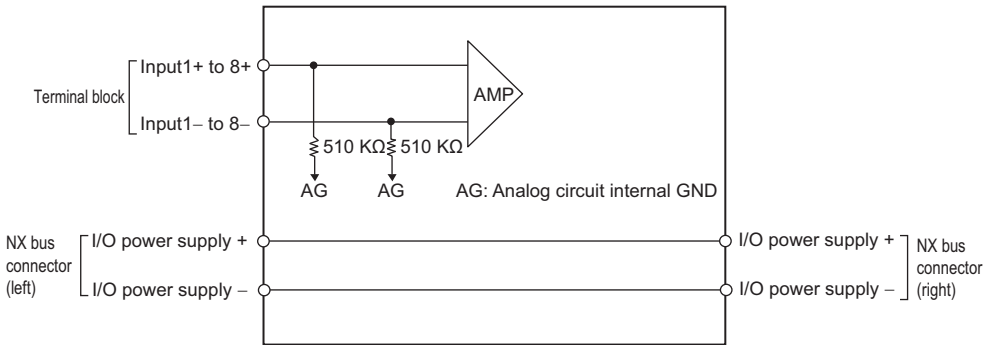
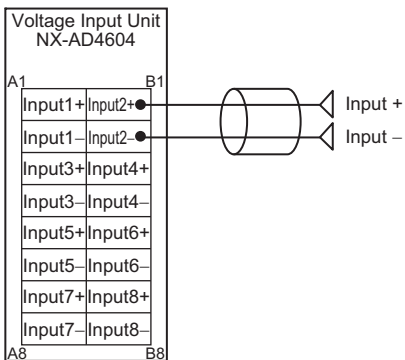
Unit name	Analog Input Unit (voltage input type)	Model	NX-AD4604	
Number of points	8 points	External connection terminals	Screwless clamping terminal block (16 terminals)	
I/O refreshing method	Free-Run refreshing			
Indicators	TS indicator 	Input method	Differential input	
		Input range	-10 to +10 V	
		Input conversion range	-5 to 105% (full scale)	
		Absolute maximum rating	±15 V	
		Input impedance	1 MΩ min.	
		Resolution	1/8000 (full scale)	
		Overall accuracy	25°C	±0.2% (full scale)
			0 to 55°C	±0.4% (full scale)
Conversion time	250 μs/point			
Dimensions	12 (W) x 100 (H) x 71 (D)	Isolation method	Between the input and the NX bus: Power = Transformer, Signal = Digital isolator (no isolation between inputs)	
Insulation resistance	20 MΩ min. between isolated circuits (at 100 VDC)	Dielectric strength	510 VAC between isolated circuits for 1 minute at a leakage current of 5 mA max.	
I/O power supply method	No supply	Current capacity of I/O power supply terminal	Without I/O power supply terminals	
NX Unit power consumption	<ul style="list-style-type: none"> Connected to a CPU Unit or Communication Control Unit 1.45 W max. Connected to a Communications Coupler Unit 1.15 W max. 	Current consumption from I/O power supply	No consumption	
Weight	70 g max.			
Circuit layout				
Installation orientation and restrictions	Installation orientation: <ul style="list-style-type: none"> Connected to a CPU Unit or Communication Control Unit Possible in upright installation. Connected to a Communications Coupler Unit Possible in 6 orientations. Restrictions: No restrictions			
Terminal connection diagram				
Input disconnection detection	Not supported.			

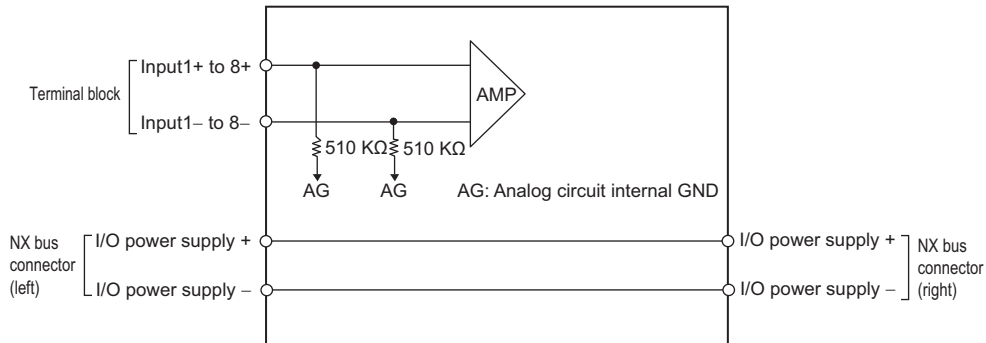
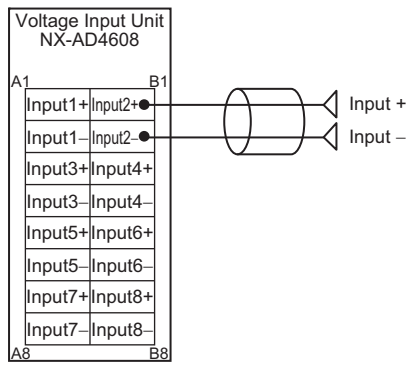
Unit name	Analog Input Unit (voltage input type)	Model	NX-AD4608				
Number of points	8 points	External connection terminals	Screwless clamping terminal block (16 terminals)				
I/O refreshing method	Switching synchronous I/O refreshing and Free-Run refreshing						
Indicators		Input method	Differential input				
		Input range	-10 to +10 V				
		Input conversion range	-5 to 105% (full scale)				
		Absolute maximum rating	±15 V				
		Input impedance	1 MΩ min.				
		Resolution	1/30000 (full scale)				
		Overall accuracy	<table border="1"> <tr> <td>25°C</td> <td>±0.1% (full scale)</td> </tr> <tr> <td>0 to 55°C</td> <td>±0.2% (full scale)</td> </tr> </table>	25°C	±0.1% (full scale)	0 to 55°C	±0.2% (full scale)
		25°C	±0.1% (full scale)				
0 to 55°C	±0.2% (full scale)						
Conversion time	10 μs/point						
Dimensions	12 (W) x 100 (H) x 71 (D)	Isolation method	Between the input and the NX bus: Power = Transformer, Signal = Digital isolator (no isolation between inputs)				
Insulation resistance	20 MΩ min. between isolated circuits (at 100 VDC)	Dielectric strength	510 VAC between isolated circuits for 1 minute at a leakage current of 5 mA max.				
I/O power supply method	No supply	Current capacity of I/O power supply terminal	Without I/O power supply terminals				
NX Unit power consumption	<ul style="list-style-type: none"> Connected to a CPU Unit or Communication Control Unit 1.45 W max. Connected to a Communications Coupler Unit 1.15 W max. 	Current consumption from I/O power supply	No consumption				
Weight	70 g max.						
Circuit layout							
Installation orientation and restrictions	<p>Installation orientation:</p> <ul style="list-style-type: none"> Connected to a CPU Unit or Communication Control Unit Possible in upright installation. Connected to a Communications Coupler Unit Possible in 6 orientations. <p>Restrictions: No restrictions</p>						
Terminal connection diagram							
Input disconnection detection	Not supported.						

A-1-3 Analog Output Units

Description of Items on the Data Sheet of the Analog Output Unit

The meanings of the items on the data sheet of the Analog Output Unit are explained in the table below.

Item	Description
Unit name	The name of the Unit.
Model	The model of the Unit.
Number of points	The number of analog output points provided by the Unit.
External connection terminals	The type of terminal block and connector that is used for connecting the Unit. The number of terminals on the terminal block is also described when a screwless clamping terminal block is used.
I/O refreshing method	The I/O refreshing methods that are used by the Unit. Free-Run refreshing and synchronous I/O refreshing are available.
Indicators	The type of indicators on the Unit and the layout of those indicators. *1
Output range	The output range of the Unit.
Output conversion range	The conversion range from the converted values of the Unit to analog output signals for the full scale. Output converted values range is fixed to the conversion limit value.
Allowable load resistance	The resistance value of external load that can be connected to the Unit. The minimum value is written for voltage output and the maximum value is written for current output.
Output impedance	The output impedance of the Unit.
Resolution	The resolution of converted values of the Unit.
Overall accuracy	The conversion accuracy of analog outputs of the Unit. It is defined under the conditions of 25°C and 0 to 55°C.
Conversion time	The time required to convert output set values of the Unit to the analog output signals.
Dimensions	The dimensions of the Unit. They are described as W x H x D. The unit is "mm".
Isolation method	The isolation method between the output circuits and internal circuits and between the output circuits of the Unit.
Insulation resistance	The insulation resistance between the output circuits and internal circuits and between the output circuits of the Unit.
Dielectric strength	The dielectric strength between the output circuits and internal circuits and between the output circuits of the Unit.
I/O power supply method	The method for supplying I/O power for the Unit. The supply method is determined for each Unit. The power is supplied from the NX bus or the external source.
Current capacity of I/O power supply terminal	The current capacity of the I/O power supply terminals (IOV/IOG) of the Unit. Do not exceed this value when supplying the I/O power to the connected external devices.
NX Unit power consumption	The power consumption of the NX Unit power supply of the Unit. The power consumption of the Unit connected to each of the following Units is separately given. If some of the following Units can not be connected to the Unit, relevant information is omitted. <ul style="list-style-type: none"> • CPU Unit • Communications Coupler Unit • Communication Control Unit
Current consumption from I/O power supply	The current consumption from I/O power supply of the Unit. The above input current and current consumption of any connected external devices are excluded.
Weight	The weight of the Unit.
Circuit layout	The output circuit layout of the Unit.
Installation orientation and restrictions	The installation orientation of the Unit. The installation orientation of the Unit connected to each of the following Units is separately given, along with details of the specifications restricted due to the installation orientation, if any. If some of the following Units can not be connected to the Unit, relevant information is omitted. <ul style="list-style-type: none"> • CPU Unit • Communications Coupler Unit • Communication Control Unit
Terminal connection diagram	A diagram of the connection between the Unit and connected external devices. When an I/O Power Supply Connection Unit or a Shield Connection Unit is required to be connected to the connected external devices, the description for such is included.

*1. The layout of the indicators after the appearance change is shown for models released in or before September 2018. For details on the applicable models and the changes, refer to 3-2-2 *Appearance Change of the Indicators* on page 3-8.

Analog Output Units (Screwless Clamping Terminal Block, 12 mm Width)

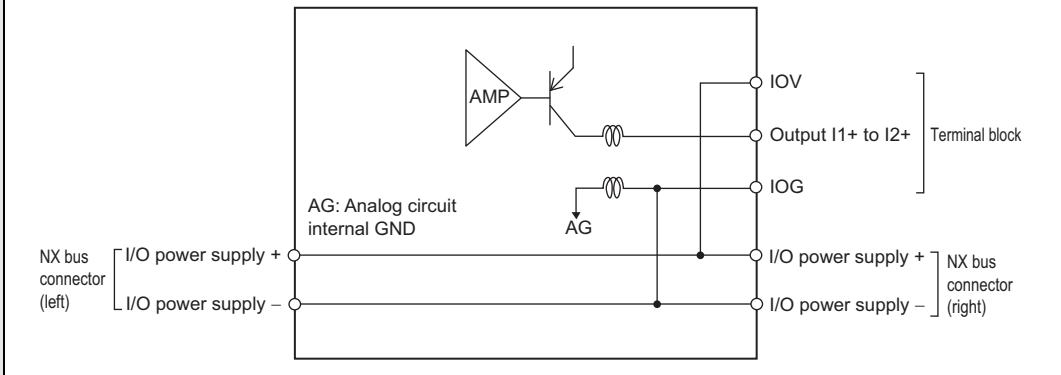
Unit name	Analog Output Unit (current output type)	Model	NX-DA2203	
Number of points	2 points	External connection terminals	Screwless clamping terminal block (8 terminals)	
I/O refreshing method	Free-Run refreshing			
Indicators	TS indicator 	Output range	4 to 20 mA	
		Output conversion range	-5 to 105% (full scale)	
		Allowable load resistance	600 Ω max.	
		Resolution	1/8000 (full scale)	
		Overall accuracy	25°C	±0.3% (full scale)
			0 to 55°C	±0.6% (full scale)
	Conversion time	250 μs/point		
Dimensions	12 (W) x 100 (H) x 71 (D)	Isolation method	Between the input and the NX bus: Power = Transformer, Signal = Digital isolator (no isolation between inputs)	
Insulation resistance	20 MΩ min. between isolated circuits (at 100 VDC)	Dielectric strength	510 VAC between isolated circuits for 1 minute at a leakage current of 5 mA max.	
I/O power supply method	Supply from the NX bus	Current capacity of I/O power supply terminal	IOV: 0.1 A/terminal max., IOG: 0.1 A/terminal max.	
NX Unit power consumption	<ul style="list-style-type: none"> Connected to a CPU Unit or Communication Control Unit 2.10 W max. Connected to a Communications Coupler Unit 1.75 W max. 	Current consumption from I/O power supply	No consumption	
Weight	70 g max.			
Circuit layout				

Installation orientation and restrictions

Installation orientation:

- Connected to a CPU Unit or Communication Control Unit
Possible in upright installation.
- Connected to a Communications Coupler Unit
Possible in 6 orientations.

Restrictions:

For upright installation: No restrictions

For any installation other than upright: Restricted as shown in the graph below.

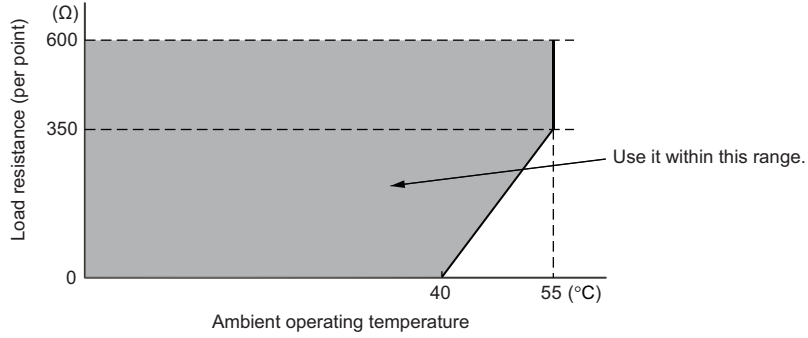

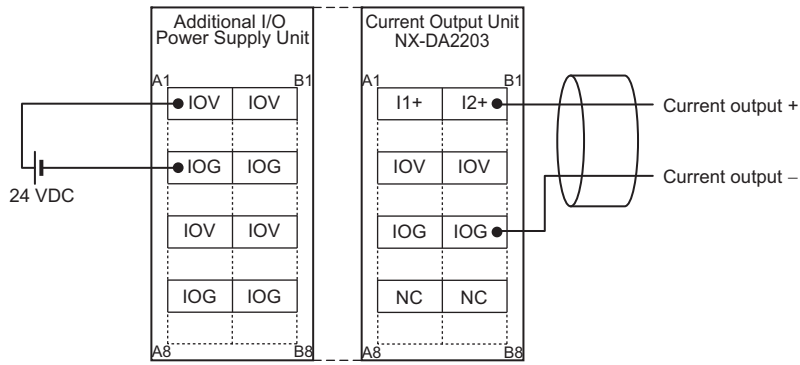

Terminal connection diagram

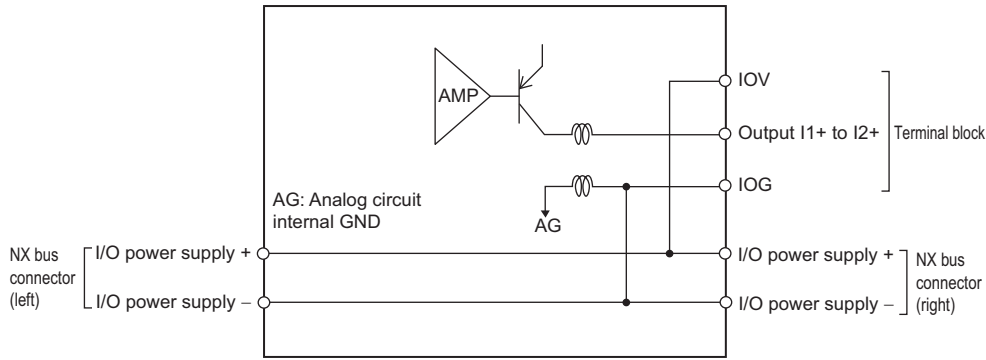
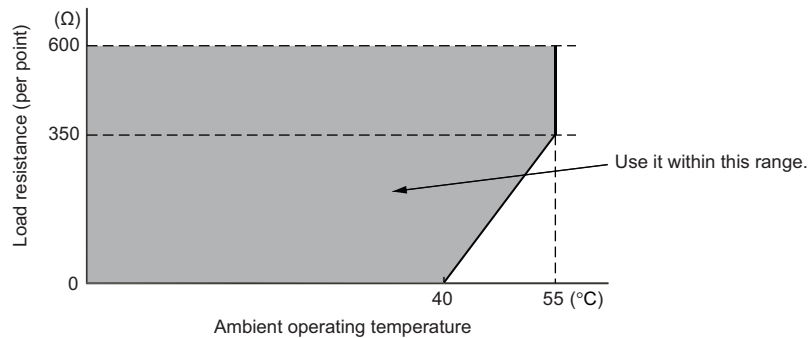

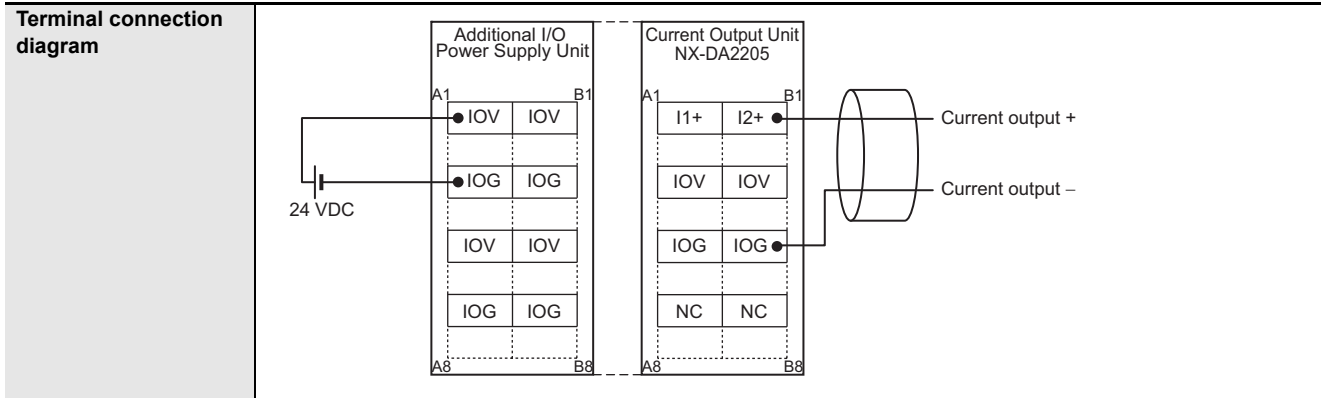
Unit name	Analog Output Unit (current output type)	Model	NX-DA2205	
Number of points	2 points	External connection terminals	Screwless clamping terminal block (8 terminals)	
I/O refreshing method	Switching synchronous I/O refreshing and Free-Run refreshing			
Indicators	TS indicator 	Output range	4 to 20 mA	
		Output conversion range	-5 to 105% (full scale)	
		Allowable load resistance	600 Ω max.	
		Resolution	1/30000 (full scale)	
		Overall accuracy	25°C	±0.1% (full scale)
			0 to 55°C	±0.3% (full scale)
Conversion time	10 μs/point			
Dimensions	12 (W) x 100 (H) x 71 (D)	Isolation method	Between the input and the NX bus: Power = Transformer, Signal = Digital isolator (no isolation between inputs)	
Insulation resistance	20 MΩ min. between isolated circuits (at 100 VDC)	Dielectric strength	510 VAC between isolated circuits for 1 minute at a leakage current of 5 mA max.	
I/O power supply method	Supply from the NX bus	Current capacity of I/O power supply terminal	IOV: 0.1 A/terminal max., IOG: 0.1 A/terminal max.	
NX Unit power consumption	<ul style="list-style-type: none"> Connected to a CPU Unit or Communication Control Unit 2.10 W max. Connected to a Communications Coupler Unit 1.75 W max. 	Current consumption from I/O power supply	No consumption	
Weight	70 g max.			
Circuit layout				
Installation orientation and restrictions	<p>Installation orientation:</p> <ul style="list-style-type: none"> Connected to a CPU Unit or Communication Control Unit Possible in upright installation. Connected to a Communications Coupler Unit Possible in 6 orientations. <p>Restrictions:</p> <p>For upright installation: No restrictions</p> <p>For any installation other than upright: Restricted as shown in the graph below.</p> 			

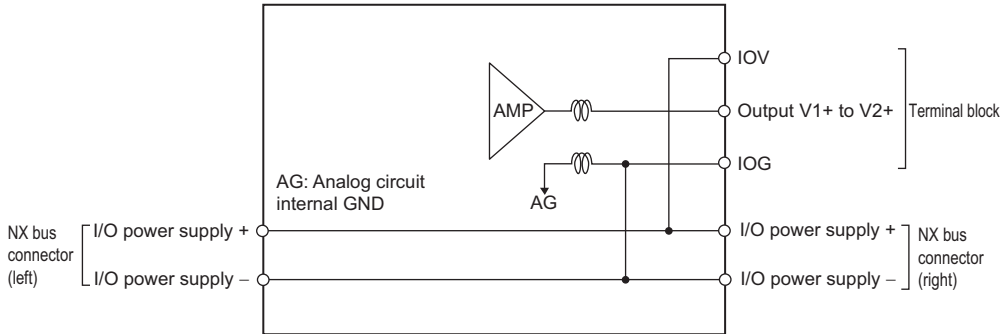
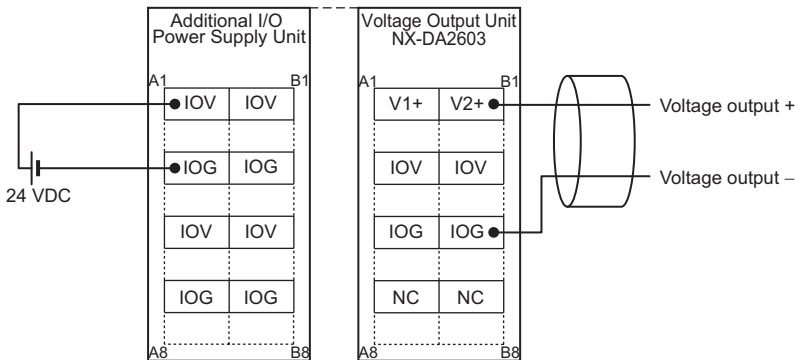

Unit name	Analog Output Unit (voltage output type)	Model	NX-DA2603	
Number of points	2 points	External connection terminals	Screwless clamping terminal block (8 terminals)	
I/O refreshing method	Free-Run refreshing			
Indicators	TS indicator 	Output range	-10 to +10 V	
		Output conversion range	-5 to 105% (full scale)	
		Allowable load resistance	5 kΩ min.	
		Output impedance	0.5 Ω max.	
		Resolution	1/8000 (full scale)	
		Overall accuracy	25°C	±0.3% (full scale)
			0 to 55°C	±0.5% (full scale)
		Conversion time	250 μs/point	
Dimensions	12 (W) x 100 (H) x 71 (D)	Isolation method	Between the input and the NX bus: Power = Transformer, Signal = Digital isolator (no isolation between inputs)	
Insulation resistance	20 MΩ min. between isolated circuits (at 100 VDC)	Dielectric strength	510 VAC between isolated circuits for 1 minute at a leakage current of 5 mA max.	
I/O power supply method	Supply from the NX bus	Current capacity of I/O power supply terminal	IOV: 0.1 A/terminal max., IOG: 0.1 A/terminal max.	
NX Unit power consumption	<ul style="list-style-type: none"> Connected to a CPU Unit or Communication Control Unit 1.40 W max. Connected to a Communications Coupler Unit 1.10 W max. 	Current consumption from I/O power supply	No consumption	
Weight	70 g max.			
Circuit layout				
Installation orientation and restrictions	Installation orientation: <ul style="list-style-type: none"> Connected to a CPU Unit or Communication Control Unit Possible in upright installation. Connected to a Communications Coupler Unit Possible in 6 orientations. Restrictions: No restrictions			
Terminal connection diagram				

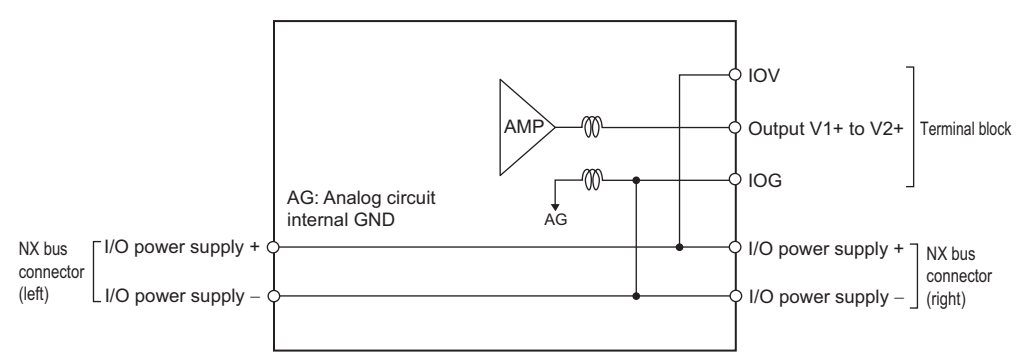
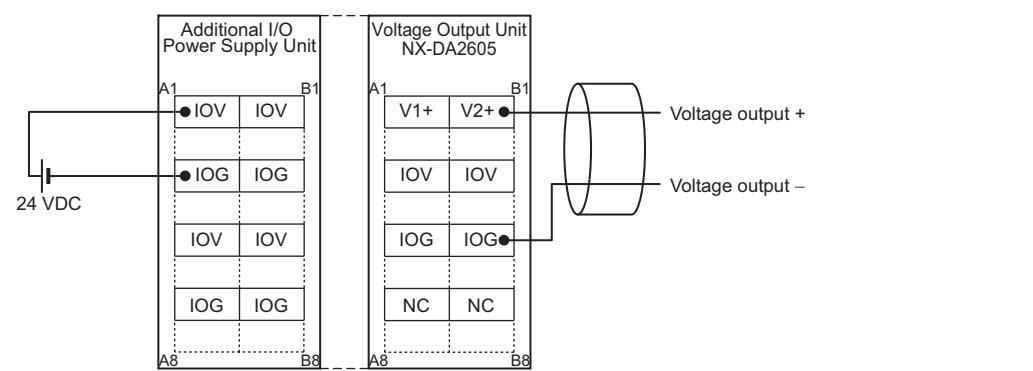
Unit name	Analog Output Unit (voltage output type)	Model	NX-DA2605	
Number of points	2 points	External connection terminals	Screwless clamping terminal block (8 terminals)	
I/O refreshing method	Switching synchronous I/O refreshing and Free-Run refreshing			
Indicators	TS indicator 	Output range	-10 to +10 V	
		Output conversion range	-5 to 105% (full scale)	
		Allowable load resistance	5 kΩ min.	
		Output impedance	0.5 Ω max.	
		Resolution	1/30000 (full scale)	
		Overall accuracy	25°C	±0.1% (full scale)
			0 to 55°C	±0.3% (full scale)
Conversion time	10 μs/point			
Dimensions	12 (W) x 100 (H) x 71 (D)	Isolation method	Between the input and the NX bus: Power = Transformer, Signal = Digital isolator (no isolation between inputs)	
Insulation resistance	20 MΩ min. between isolated circuits (at 100 VDC)	Dielectric strength	510 VAC between isolated circuits for 1 minute at a leakage current of 5 mA max.	
I/O power supply method	Supply from the NX bus	Current capacity of I/O power supply terminal	IOV: 0.1 A/terminal max., IOG: 0.1 A/terminal max.	
NX Unit power consumption	<ul style="list-style-type: none"> Connected to a CPU Unit or Communication Control Unit 1.40 W max. Connected to a Communications Coupler Unit 1.10 W max. 	Current consumption from I/O power supply	No consumption	
Weight	70 g max.			
Circuit layout				
Installation orientation and restrictions	Installation orientation: <ul style="list-style-type: none"> Connected to a CPU Unit or Communication Control Unit Possible in upright installation. Connected to a Communications Coupler Unit Possible in 6 orientations. Restrictions: No restrictions			
Terminal connection diagram				

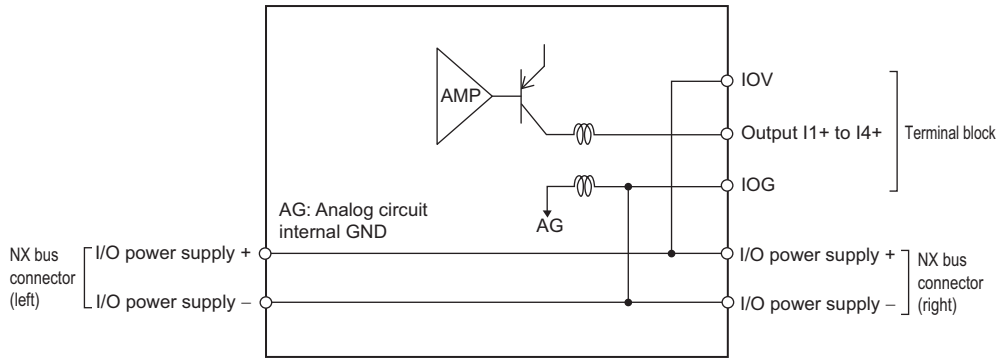
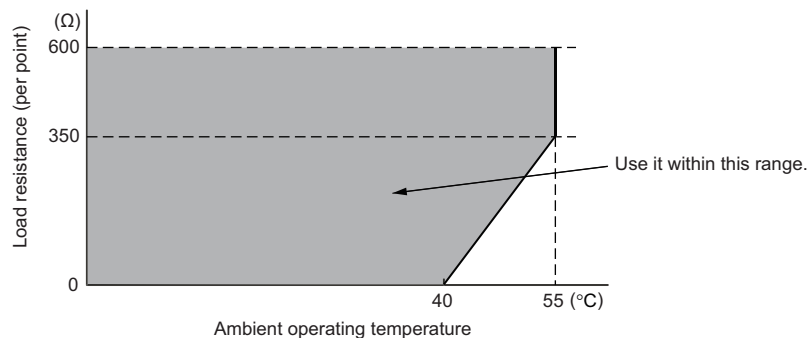
Unit name	Analog Output Unit (current output type)	Model	NX-DA3203	
Number of points	4 points	External connection terminals	Screwless clamping terminal block (12 terminals)	
I/O refreshing method	Free-Run refreshing			
Indicators	TS indicator 	Output range	4 to 20 mA	
		Output conversion range	-5 to 105% (full scale)	
		Allowable load resistance	350 Ω max.	
		Resolution	1/8000 (full scale)	
		Overall accuracy	25°C	±0.3% (full scale)
			0 to 55°C	±0.6% (full scale)
Conversion time	250 μs/point			
Dimensions	12 (W) x 100 (H) x 71 (D)	Isolation method	Between the input and the NX bus: Power = Transformer, Signal = Digital isolator (no isolation between inputs)	
Insulation resistance	20 MΩ min. between isolated circuits (at 100 VDC)	Dielectric strength	510 VAC between isolated circuits for 1 minute at a leakage current of 5 mA max.	
I/O power supply method	Supply from the NX bus	Current capacity of I/O power supply terminal	IOV: 0.1 A/terminal max., IOG: 0.1 A/terminal max.	
NX Unit power consumption	<ul style="list-style-type: none"> Connected to a CPU Unit or Communication Control Unit 2.10 W max. Connected to a Communications Coupler Unit 1.80 W max. 	Current consumption from I/O power supply	No consumption	
Weight	70 g max.			
Circuit layout				
Installation orientation and restrictions	<p>Installation orientation:</p> <ul style="list-style-type: none"> Connected to a CPU Unit or Communication Control Unit Possible in upright installation. Connected to a Communications Coupler Unit Possible in 6 orientations. <p>Restrictions:</p> <p>For upright installation: No restrictions</p> <p>For any installation other than upright: Restricted as shown in the graph below.</p> 			

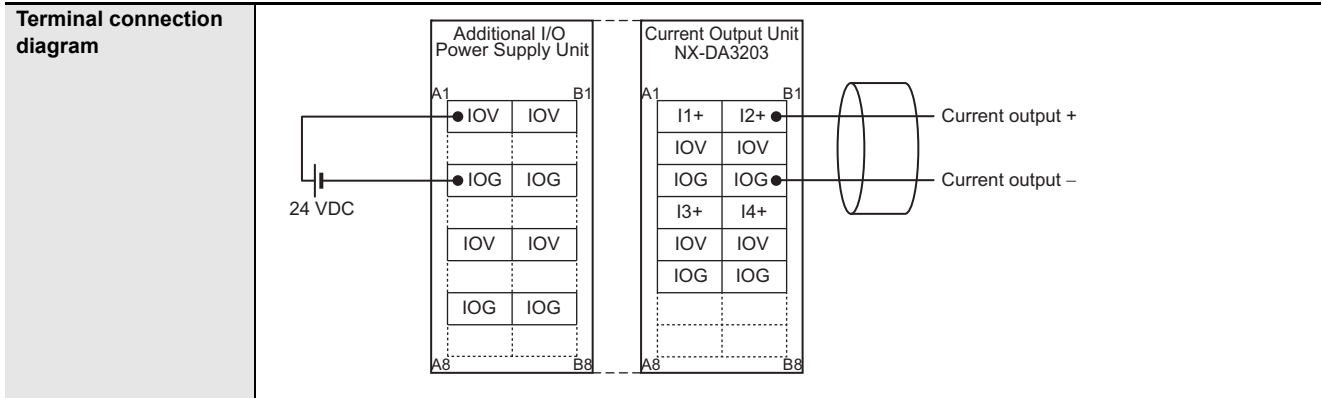

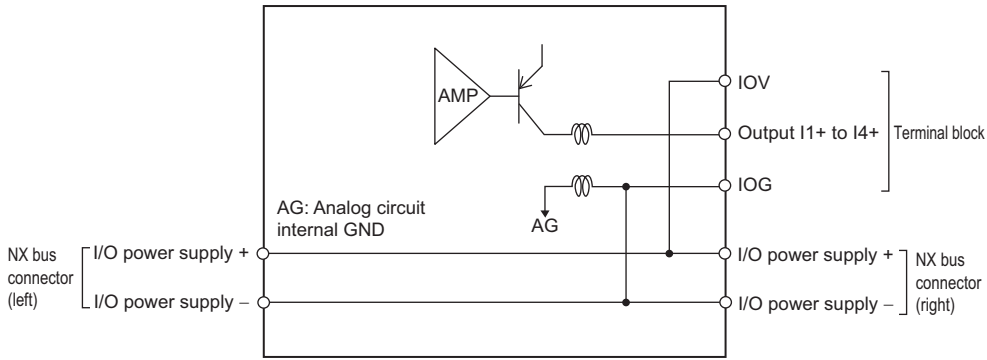
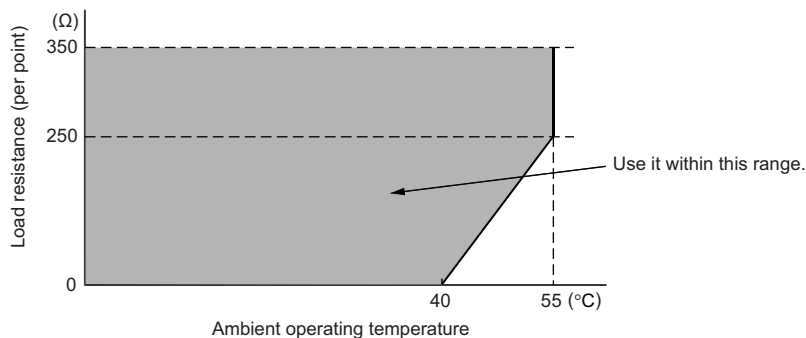
Unit name	Analog Output Unit (current output type)	Model	NX-DA3205	
Number of points	4 points	External connection terminals	Screwless clamping terminal block (12 terminals)	
I/O refreshing method	Switching synchronous I/O refreshing and Free-Run refreshing			
Indicators	TS indicator 	Output range	4 to 20 mA	
		Output conversion range	-5 to 105% (full scale)	
		Allowable load resistance	350 Ω max.	
		Resolution	1/30000 (full scale)	
		Overall accuracy	25°C	±0.1% (full scale)
			0 to 55°C	±0.3% (full scale)
Conversion time	10 μs/point			
Dimensions	12 (W) x 100 (H) x 71 (D)	Isolation method	Between the input and the NX bus: Power = Transformer, Signal = Digital isolator (no isolation between inputs)	
Insulation resistance	20 MΩ min. between isolated circuits (at 100 VDC)	Dielectric strength	510 VAC between isolated circuits for 1 minute at a leakage current of 5 mA max.	
I/O power supply method	Supply from the NX bus	Current capacity of I/O power supply terminal	IOV: 0.1 A/terminal max., IOG: 0.1 A/terminal max.	
NX Unit power consumption	<ul style="list-style-type: none"> Connected to a CPU Unit or Communication Control Unit 2.10 W max. Connected to a Communications Coupler Unit 1.80 W max. 	Current consumption from I/O power supply	No consumption	
Weight	70 g max.			
Circuit layout				
Installation orientation and restrictions	<p>Installation orientation:</p> <ul style="list-style-type: none"> Connected to a CPU Unit or Communication Control Unit Possible in upright installation. Connected to a Communications Coupler Unit Possible in 6 orientations. <p>Restrictions:</p> <p>For upright installation: No restrictions</p> <p>For any installation other than upright: Restricted as shown in the graph below.</p> 			

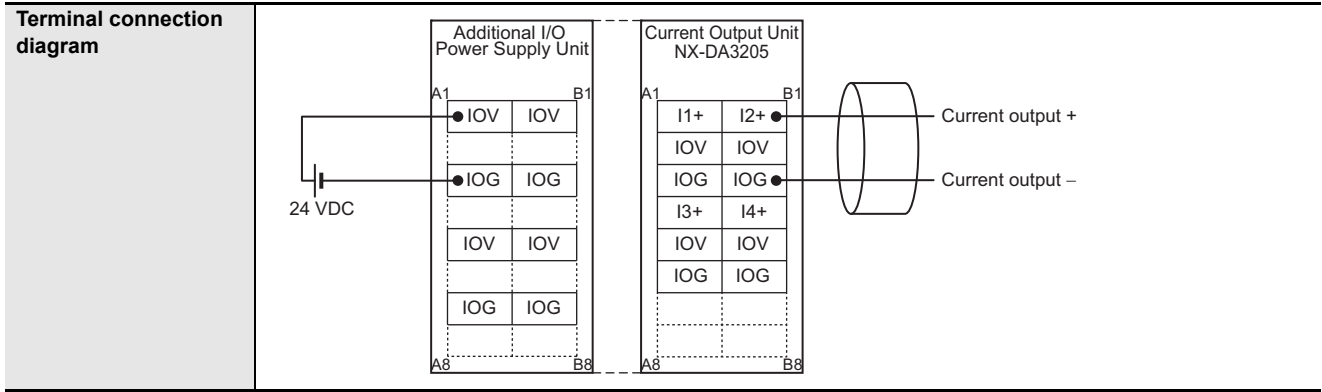

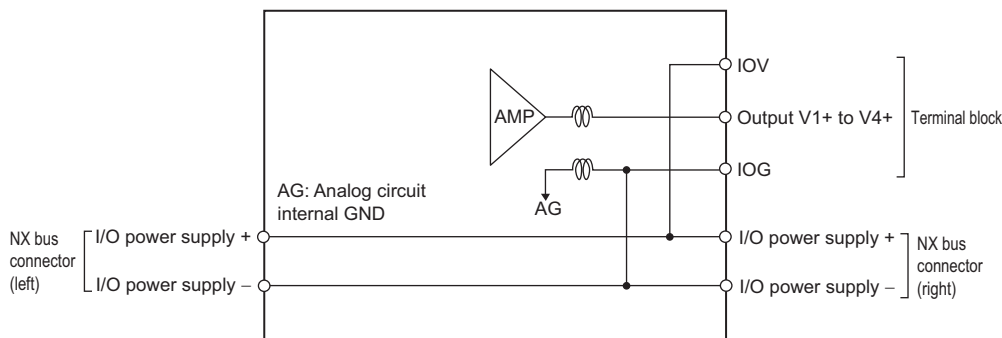
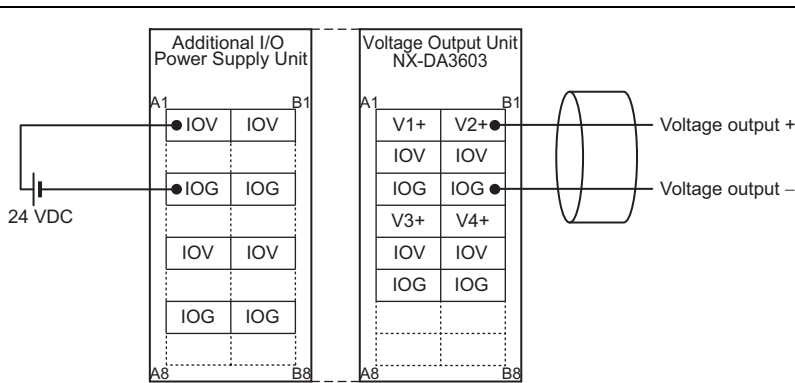
Unit name	Analog Output Unit (voltage output type)	Model	NX-DA3603				
Number of points	4 points	External connection terminals	Screwless clamping terminal block (12 terminals)				
I/O refreshing method	Free-Run refreshing						
Indicators	TS indicator 	Output range	-10 to +10 V				
		Output conversion range	-5 to 105% (full scale)				
		Allowable load resistance	5 kΩ min.				
		Output impedance	0.5 Ω max.				
		Resolution	1/8000 (full scale)				
		Overall accuracy	<table border="1"> <tr> <td>25°C</td> <td>±0.3% (full scale)</td> </tr> <tr> <td>0 to 55°C</td> <td>±0.5% (full scale)</td> </tr> </table>	25°C	±0.3% (full scale)	0 to 55°C	±0.5% (full scale)
		25°C	±0.3% (full scale)				
		0 to 55°C	±0.5% (full scale)				
Conversion time	250 μs/point						
Dimensions	12 (W) x 100 (H) x 71 (D)	Isolation method	Between the input and the NX bus: Power = Transformer, Signal = Digital isolator (no isolation between inputs)				
Insulation resistance	20 MΩ min. between isolated circuits (at 100 VDC)	Dielectric strength	510 VAC between isolated circuits for 1 minute at a leakage current of 5 mA max.				
I/O power supply method	Supply from the NX bus	Current capacity of I/O power supply terminal	IOV: 0.1 A/terminal max., IOG: 0.1 A/terminal max.				
NX Unit power consumption	<ul style="list-style-type: none"> Connected to a CPU Unit or Communication Control Unit 1.35 W max. Connected to a Communications Coupler Unit 1.25 W max. 	Current consumption from I/O power supply	No consumption				
Weight	70 g max.						
Circuit layout							
Installation orientation and restrictions	Installation orientation: <ul style="list-style-type: none"> Connected to a CPU Unit or Communication Control Unit Possible in upright installation. Connected to a Communications Coupler Unit Possible in 6 orientations. Restrictions: No restrictions						
Terminal connection diagram							

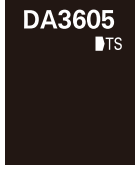
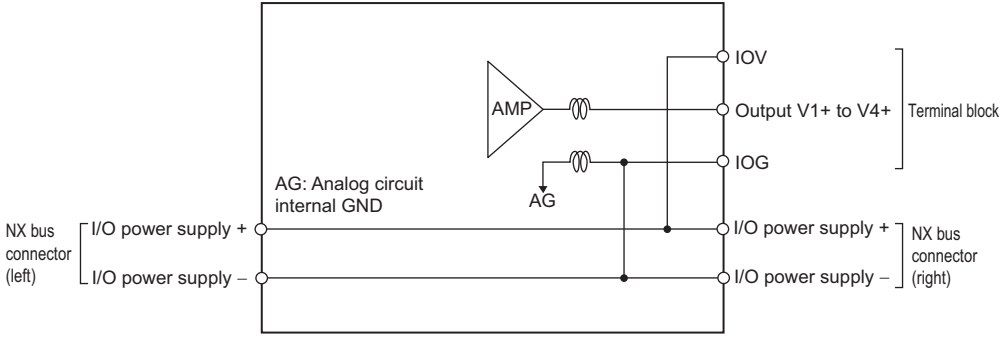
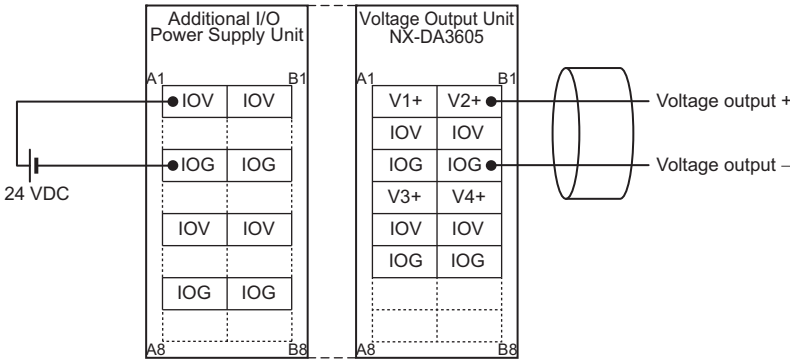
Unit name	Analog Output Unit (voltage output type)	Model	NX-DA3605	
Number of points	4 points	External connection terminals	Screwless clamping terminal block (12 terminals)	
I/O refreshing method	Switching synchronous I/O refreshing and Free-Run refreshing			
Indicators	TS indicator 	Output range	-10 to +10 V	
		Output conversion range	-5 to 105% (full scale)	
		Allowable load resistance	5 kΩ min.	
		Output impedance	0.5 Ω max.	
		Resolution	1/30000 (full scale)	
		Overall accuracy	25°C	±0.1% (full scale)
			0 to 55°C	±0.3% (full scale)
Conversion time	10 μs/point			
Dimensions	12 (W) x 100 (H) x 71 (D)	Isolation method	Between the input and the NX bus: Power = Transformer, Signal = Digital isolator (no isolation between inputs)	
Insulation resistance	20 MΩ min. between isolated circuits (at 100 VDC)	Dielectric strength	510 VAC between isolated circuits for 1 minute at a leakage current of 5 mA max.	
I/O power supply method	Supply from the NX bus	Current capacity of I/O power supply terminal	IOV: 0.1 A/terminal max., IOG: 0.1 A/terminal max.	
NX Unit power consumption	<ul style="list-style-type: none"> Connected to a CPU Unit or Communication Control Unit 1.60 W max. Connected to a Communications Coupler Unit 1.25 W max. 	Current consumption from I/O power supply	No consumption	
Weight	70 g max.			
Circuit layout				
Installation orientation and restrictions	Installation orientation: <ul style="list-style-type: none"> Connected to a CPU Unit or Communication Control Unit Possible in upright installation. Connected to a Communications Coupler Unit Possible in 6 orientations. Restrictions: No restrictions			
Terminal connection diagram				

A-2 Dimensions

A-2-1 Screwless Clamping Terminal Block Type

12 mm Width

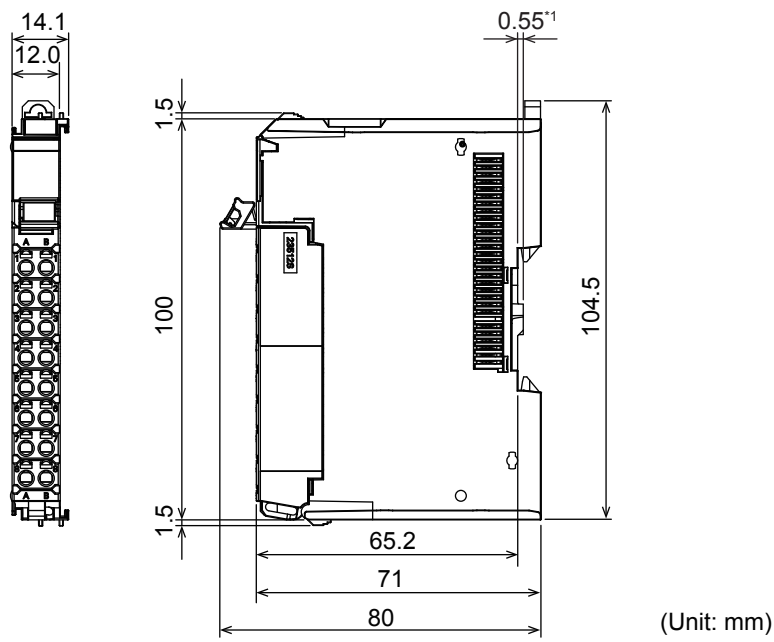

*1. The dimension is 1.35 mm for Units with lot numbers through December 2014.

Installation Height

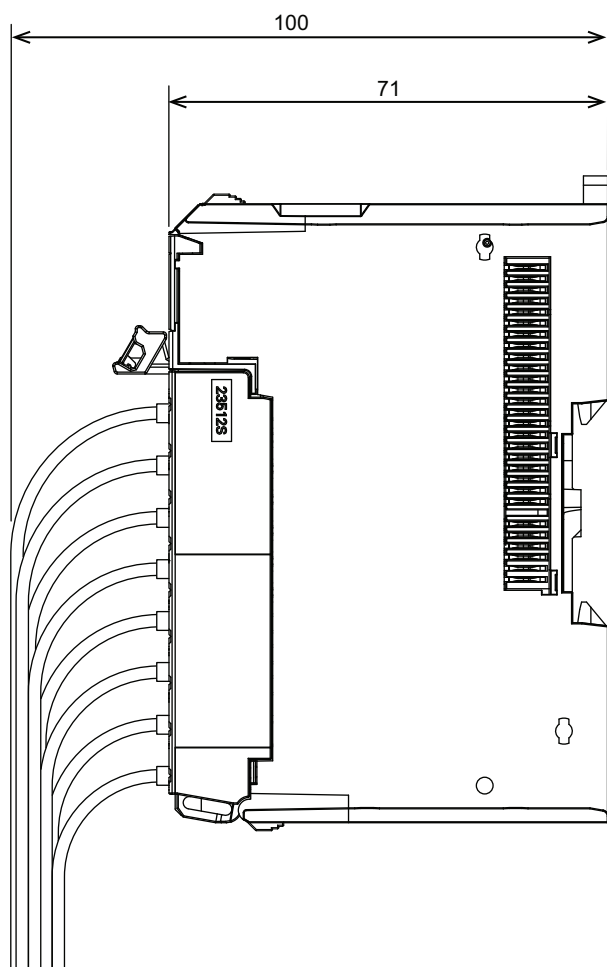

(Unit: mm)

A-3 List of NX Objects

This section describes the NX objects of the Analog Input Units and Analog Output Units.

The method to access NX objects through instructions or other messages depends on where the NX Unit is connected.

If the NX Unit is connected to a CPU Unit, access is possible with the Read NX Unit Object instruction and the Write NX Unit Object instruction.

When the NX Unit is connected to a Communications Coupler Unit, the method depends on the connected communications master and Communications Coupler Unit.

Refer to the user's manual for the connected Communications Coupler Unit for method to use messages to access NX objects on Slave Terminals.

Refer to the user's manual for the Communication Control Unit for the method to use messages to access NX objects of NX Units connected to a Communication Control Unit.

A-3-1 Format of Object Descriptions

In this manual, NX objects are described with the following format.

Index (hex)	Subindex (hex)	Object name	Default value	Data range	Unit	Data type	Access	I/O allocation	Data attribute

- Index (Hex) : This is the index of the NX object that is expressed as a four-digit hexadecimal number.
- Subindex (Hex) : This is the subindex of the NX object that is expressed as a two-digit hexadecimal number.
- Object name : This is the name of the object. For a subindex, this is the name of the subindex.
- Default value : This is the value that is set by default.
- Data range : For a read-only (RO) NX object, this is the range of the data you can read. For a read-write (RW) NX object, this is the setting range of the data.
- Unit : The unit is the physical units.
- Data type : This is the data type of the object.
- Access : This data tells if the object is read-only or read/write.
 RO: Read only
 RW: Read/write
- I/O allocation : This tells whether I/O allocation is allowed.
- Data attribute : This is the timing when changes to writable NX objects are enabled.
 Y: Enabled by restarting
 N: Enabled at all times
 ---: Write-prohibited

A-3-2 Analog Input Units

Unit Information Objects

This object gives the product information.

Index (hex)	Subindex (hex)	Object name	Default value	Data range	Unit	Data type	Access	I/O allocation	Data attribute
1000	---	NX Bus Identity	---	---	---	---	---	---	---
	00	Number of Entries	7	7	---	USINT	RO	Not possible	---
	02	Model	*1	---	---	ARRAY [0..11] OF BYTE	RO	Not possible	---
	03	Device Type	*2	---	---	UDINT	RO	Not possible	---
	04	Product Code	*3	---	---	UDINT	RO	Not possible	---
	05	Vendor Code	00000001 hex *4	---	---	UDINT	RO	Not possible	---
	06	Unit Version	*5	---	---	UDINT	RO	Not possible	---
	07	Serial Number	*6	00000000 to FFFFFFFF hex	---	UDINT	RO	Not possible	---
1001	---	Production Info	---	---	---	---	---	---	---
	00	Number of Entries	2	2	---	USINT	RO	Not possible	---
	01	Lot Number	*7	00000000 to FFFFFFFF hex	---	UDINT	RO	Not possible	---
	02	Hardware Version	*8	---	---	ARRAY [0..19] OF BYTE	RO	Not possible	---

*1. The product models are assigned in ascending order from the lowest number of array elements. Any remainder elements are filled with spaces.

*2. The device types are assigned for each product Unit type.
Bits 0 to 31: Device type

*3. The product codes are assigned for each product model.
Bits 0 to 31: Product code

*4. OMRON vendor code

*5. Bits 24 to 31: Integer part of the Unit version.
Bits 16 to 23: Fractional part of the Unit version.
Bits 0 to 15: Reserved
(Example) For Ver.1.0, 0100□□□□ hex

*6. A unique serial number is assigned for each product unit.
Bits 0 to 31: Serial number

*7. The year, month, and day of production are assigned to the "lot number".
Bits 24 to 31: Date of production
Bits 16 to 23: Month of production
Bits 8 to 15: Year of production
Bits 0 to 7: Reserved

*8. The hardware version is assigned in ascending order from the earliest number of array elements. Any remainder elements are filled with spaces.

Objects That Accept I/O Allocations

These objects accept I/O allocations.

You cannot access the objects that are described below with the Read NX Unit Object instruction, Write NX Unit Object instruction, or other messages.

Index (hex)	Subindex (hex)	Object name	Default value	Data range	Unit	Data type	Access	I/O allocation	Data attribute
6000	---	Analog Input Value	---	---	---	---	---	---	---
	00	Number of Entries	*1	*1	---	USINT	RO	Not possible	---
	01	Ch1 Analog Input Value	0	-32768 to 32767	---	INT	RO	Possible	---
	02	Ch2 Analog Input Value	0	-32768 to 32767	---	INT	RO	Possible	---
	03	Ch3 Analog Input Value	0	-32768 to 32767	---	INT	RO	Possible	---
	04	Ch4 Analog Input Value	0	-32768 to 32767	---	INT	RO	Possible	---
	05	Ch5 Analog Input Value	0	-32768 to 32767	---	INT	RO	Possible	---
	06	Ch6 Analog Input Value	0	-32768 to 32767	---	INT	RO	Possible	---
	07	Ch7 Analog Input Value	0	-32768 to 32767	---	INT	RO	Possible	---
	08	Ch8 Analog Input Value	0	-32768 to 32767	---	INT	RO	Possible	---

*1. The default value and data range for Number of Entries are as follows.

NX Units	Default value	Data range
NX-AD2203/AD2204/AD2208/ AD2603/AD2604/AD2608	2	2
NX-AD3203/AD3204/AD3208/ AD3603/AD3604/AD3608/	4	4
NX-AD4203/AD4204/AD4208/ AD4603/AD4604/AD4608/	8	8
Other models	0	0

Other Objects

This section lists other objects.

Index (hex)	Subindex (hex)	Object name	Default value	Data range	Unit	Data type	Access	I/O allocation	Data attribute
5002	---	Input Enable/Disable Setting	---	---	---	---	---	---	---
	00	Number of Entries	*1	*1	---	USINT	RO	Not possible	---
	01	Ch1 Enable/Disable	TRUE	TRUE or FALSE *2	---	BOOL	RW	Not possible	Y
	02	Ch2 Enable/Disable	TRUE		---	BOOL	RW	Not possible	Y
	03	Ch3 Enable/Disable	TRUE		---	BOOL	RW	Not possible	Y
	04	Ch4 Enable/Disable	TRUE		---	BOOL	RW	Not possible	Y
	05	Ch5 Enable/Disable	TRUE		---	BOOL	RW	Not possible	Y
	06	Ch6 Enable/Disable	TRUE		---	BOOL	RW	Not possible	Y
	07	Ch7 Enable/Disable	TRUE		---	BOOL	RW	Not possible	Y
	08	Ch8 Enable/Disable	TRUE		---	BOOL	RW	Not possible	Y

*1. The default value and data range for Number of Entries are as follows.

NX Units	Default value	Data range
NX-AD2203/AD2204/AD2208/ AD2603/AD2604/AD2608	2	2
NX-AD3203/AD3204/AD3208/ AD3603/AD3604/AD3608	4	4
NX-AD4203/AD4204/AD4208/ AD4603/AD4604/AD4608	8	8
Other models	0	0

*2. The meanings of the set values for Ch□ Enable/Disable are as follows.

Set value	Meaning
FALSE	Disable
TRUE	Enable

Index (hex)	Subindex (hex)	Object name	Default value	Data range	Unit	Data type	Access	I/O allocation	Data attribute
5003	---	Input Range Setting	---	---	---	---	---	---	---
	00	Number of Entries	*1	*1	---	USINT	RO	Not possible	---
	01	Ch1 Range Setting	*2	*2	---	UINT	RW	Not possible	Y
	02	Ch2 Range Setting			---	UINT	RW	Not possible	Y
	03	Ch3 Range Setting			---	UINT	RW	Not possible	Y
	04	Ch4 Range Setting			---	UINT	RW	Not possible	Y
	05	Ch5 Range Setting			---	UINT	RW	Not possible	Y
	06	Ch6 Range Setting			---	UINT	RW	Not possible	Y
	07	Ch7 Range Setting			---	UINT	RW	Not possible	Y
	08	Ch8 Range Setting			---	UINT	RW	Not possible	Y

*1. The default value and data range for Number of Entries are as follows.

NX Units	Default value	Data range
NX-AD2203/AD2204/AD2208/ AD2603/AD2604/AD2608	2	2
NX-AD3203/AD3204/AD3208/ AD3603/AD3604/AD3608	4	4
NX-AD4203/AD4204/AD4208/ AD4603/AD4604/AD4608	8	8
Other models	0	0

*2. The default value and data range for Ch□ Range Setting are as follows.

NX Units	Set value	Meaning	Default value	Data range
NX-AD2203/AD2204/AD2208/ AD3203/AD3204/AD3208/ AD4203/AD4204/AD4208	0	4 to 20 mA	0	0
	1	0 to 10 V		
	2	-10 to +10 V		
	3	0 to 5 V		
	4	1 to 5 V		
	5	0 to 20 mA		

NX Units	Set value	Meaning	Default value	Data range
NX-AD2603/AD2604/AD2608/ AD3603/AD3604/AD3608/ AD4603/AD4604/AD4608	0	4 to 20 mA	2	2
	1	0 to 10 V		
	2	-10 to +10 V		
	3	0 to 5 V		
	4	1 to 5 V		
	5	0 to 20 mA		

Index (hex)	Subindex (hex)	Object name	Default value	Data range	Unit	Data type	Access	I/O allocation	Data attribute
5004	---	Input Moving Average Time	---	---	---	---	---	---	---
	00	Number of Entries	*1	*1	---	USINT	RO	Not possible	---
	01	Ch1 Input Moving Average Time	0	*2	μs	UINT	RW	Not possible	Y
	02	Ch2 Input Moving Average Time	0			UINT	RW	Not possible	Y
	03	Ch3 Input Moving Average Time	0			UINT	RW	Not possible	Y
	04	Ch4 Input Moving Average Time	0			UINT	RW	Not possible	Y
	05	Ch5 Input Moving Average Time	0			UINT	RW	Not possible	Y
	06	Ch6 Input Moving Average Time	0			UINT	RW	Not possible	Y
	07	Ch7 Input Moving Average Time	0			UINT	RW	Not possible	Y
	08	Ch8 Input Moving Average Time	0			UINT	RW	Not possible	Y

*1. The default value and data range for Number of Entries are as follows.

NX Units	Default value	Data range
NX-AD2203/AD2204/AD2208/ AD2603/AD2604/AD2608	2	2
NX-AD3203/AD3204/AD3208/ AD3603/AD3604/AD3608	4	4
NX-AD4203/AD4204/AD4208/ AD4603/AD4604/AD4608	8	8
Other models	0	0

*2. The setting range of Ch□ Input Moving Average Time depends on the model. The input moving average time data range for each type is as follows.

NX Units	Data range
NX-AD2203/AD2204/AD2603/ AD2604/AD3203/AD3204/ AD3603/AD3604/AD4203/ AD4204/AD4603/AD4604	0 to 32000
NX-AD2208/AD2608/AD3208/ AD3608/AD4208/AD4608	0 to 640

Index (hex)	Subindex (hex)	Object name	Default value	Data range	Unit	Data type	Access	I/O allocation	Data attribute
5005	---	Disconnection Detection Status	---	---	---	---	---	---	---
	00	Number of Entries	*1	*1	---	USINT	RO	Not possible	---
	01	Ch1 Disconnection Detection Status	FALSE	TRUE or FALSE *2	---	BOOL	RO	Not possible	---
	02	Ch2 Disconnection Detection Status	FALSE		---	BOOL	RO	Not possible	---
	03	Ch3 Disconnection Detection Status	FALSE		---	BOOL	RO	Not possible	---
	04	Ch4 Disconnection Detection Status	FALSE		---	BOOL	RO	Not possible	---
	05	Ch5 Disconnection Detection Status	FALSE		---	BOOL	RO	Not possible	---
	06	Ch6 Disconnection Detection Status	FALSE		---	BOOL	RO	Not possible	---
	07	Ch7 Disconnection Detection Status	FALSE		---	BOOL	RO	Not possible	---
	08	Ch8 Disconnection Detection Status	FALSE		---	BOOL	RO	Not possible	---

*1. The default value and data range for Number of Entries are as follows.

NX Units	Default value	Data range
NX-AD2203/AD2204/AD2208/ AD2603/AD2604/AD2608	2	2
NX-AD3203/AD3204/AD3208/ AD3603/AD3604/AD3608	4	4
NX-AD4203/AD4204/AD4208/ AD4603/AD4604/AD4608	8	8
Other models	0	0

*2. The meanings of the set values for Ch□ Disconnection Detection Status are as follows.

Value	Meaning
FALSE	Disconnection Undetected
TRUE	Disconnection Detected

Index (hex)	Subindex (hex)	Object name	Default value	Data range	Unit	Data type	Access	I/O allocation	Data attribute
5006	---	Input Over Range/Under Range Status	---	---	---	---	---	---	---
	00	Number of Entries	*1	*1	---	USINT	RO	Not possible	---
	01	Ch1 Over Range Status	FALSE	TRUE or FALSE *2	---	BOOL	RO	Not possible	---
	02	Ch1 Under Range Status	FALSE		---	BOOL	RO	Not possible	---
	03	Ch2 Over Range Status	FALSE		---	BOOL	RO	Not possible	---
	04	Ch2 Under Range Status	FALSE		---	BOOL	RO	Not possible	---
	05	Ch3 Over Range Status	FALSE		---	BOOL	RO	Not possible	---
	06	Ch3 Under Range Status	FALSE		---	BOOL	RO	Not possible	---
	07	Ch4 Over Range Status	FALSE		---	BOOL	RO	Not possible	---
	08	Ch4 Under Range Status	FALSE		---	BOOL	RO	Not possible	---
	09	Ch5 Over Range Status	FALSE		---	BOOL	RO	Not possible	---
	0A	Ch5 Under Range Status	FALSE		---	BOOL	RO	Not possible	---
	0B	Ch6 Over Range Status	FALSE		---	BOOL	RO	Not possible	---
	0C	Ch6 Under Range Status	FALSE		---	BOOL	RO	Not possible	---
	0D	Ch7 Over Range Status	FALSE		---	BOOL	RO	Not possible	---
	0E	Ch7 Under Range Status	FALSE		---	BOOL	RO	Not possible	---
	0F	Ch8 Over Range Status	FALSE		---	BOOL	RO	Not possible	---
	10	Ch8 Under Range Status	FALSE		---	BOOL	RO	Not possible	---

*1. The default value and data range for Number of Entries are as follows.

NX Units	Default value	Data range
NX-AD2203/AD2204/AD2208/ AD2603/AD2604/AD2608	4	4
NX-AD3203/AD3204/AD3208/ AD3603/AD3604/AD3608	8	8
NX-AD4203/AD4204/AD4208/ AD4603/AD4604/AD4608	16	16
Other models	0	0

*2. The meanings of Ch□ Over Range Status/Ch□ Under Range Status are as follows.

Value	Meaning
FALSE	Over Range/Under Range Undetected
TRUE	Over Range/Under Range Detected

A-3-3 Analog Output Units

Unit Information Objects

This object gives the product information.

Index (hex)	Subindex (hex)	Object name	Default value	Data range	Unit	Data type	Access	I/O allocation	Data attribute
1000	---	NX Bus Identity	---	---	---	---	---	---	---
	00	Number of Entries	7	7	---	USINT	RO	Not possible	---
	02	Model	*1	---	---	ARRAY [0..11] OF BYTE	RO	Not possible	---
	03	Device Type	*2	---	---	UDINT	RO	Not possible	---
	04	Product Code	*3	---	---	UDINT	RO	Not possible	---
	05	Vendor Code	00000001 hex *4	---	---	UDINT	RO	Not possible	---
	06	Unit Version	*5	---	---	UDINT	RO	Not possible	---
	07	Serial Number	*6	00000000 to FFFFFFFF hex	---	UDINT	RO	Not possible	---
1001	---	Production Info	---	---	---	---	---	---	---
	00	Number of Entries	2	2	---	USINT	RO	Not possible	---
	01	Lot Number	*7	00000000 to FFFFFFFF hex	---	UDINT	RO	Not possible	---
	02	Hardware Version	*8	---	---	ARRAY [0..19] OF BYTE	RO	Not possible	---

*1. The product models are assigned in ascending order from the lowest number of array elements. Any remainder elements are filled with spaces.

*2. The device types are assigned for each product Unit type.
Bits 0 to 31: Device type

*3. The product codes are assigned for each product model.
Bits 0 to 31: Product code

*4. OMRON vendor code

*5. Bits 24 to 31: Integer part of the Unit version.
Bits 16 to 23: Fractional part of the Unit version.
Bits 0 to 15: Reserved
(Example) For Ver.1.0, 0100□□□□ hex

*6. A unique serial number is assigned for each product unit.
Bits 0 to 31: Serial number

*7. The year, month, and day of production are assigned to the "lot number".
Bits 24 to 31: Date of production
Bits 16 to 23: Month of production
Bits 8 to 15: Year of production
Bits 0 to 7: Reserved

*8. The hardware version is assigned in ascending order from the earliest number of array elements. Any remainder elements are filled with spaces.

Objects That Accept I/O Allocations

These objects accept I/O allocations.

You cannot access the objects that are described below with the Read NX Unit Object instruction, Write NX Unit Object instruction, or other messages.

Index (hex)	Subindex (hex)	Object name	Default value	Data range	Unit	Data type	Access	I/O allocation	Data attribute
7000	---	Analog Output Value	---	---	---	---	---	---	---
	00	Number of Entries	*1	*1	---	USINT	RO	Not possible	---
	01	Ch1 Analog Output Value	0	-32768 to 32767	---	INT	RW	Possible	N
	02	Ch2 Analog Output Value	0	-32768 to 32767	---	INT	RW	Possible	N
	03	Ch3 Analog Output Value	0	-32768 to 32767	---	INT	RW	Possible	N
	04	Ch4 Analog Output Value	0	-32768 to 32767	---	INT	RW	Possible	N

*1. The default value and data range for Number of Entries are as follows.

NX Units	Default value	Data range
NX-DA2203/DA2205/DA2603/DA2605	2	2
NX-DA3203/DA3205/DA3603/DA3605	4	4
Other models	0	0

Other Objects

This section lists other objects.

Index (hex)	Subindex (hex)	Object name	Default value	Data range	Unit	Data type	Access	I/O allocation	Data attribute
5010	---	Output Enabled/Disabled Setting	---	---	---	---	---	---	---
	00	Number of Entries	*1	*1	---	USINT	RO	Not possible	---
	01	Ch1 Enable/Disable	TRUE	TRUE or FALSE*2	---	BOOL	RW	Not possible	Y
	02	Ch2 Enable/Disable	TRUE		---	BOOL	RW	Not possible	Y
	03	Ch3 Enable/Disable	TRUE		---	BOOL	RW	Not possible	Y
	04	Ch4 Enable/Disable	TRUE		---	BOOL	RW	Not possible	Y

*1. The default value and data range for Number of Entries are as follows.

NX Units	Default value	Data range
NX-DA2203/DA2205/DA2603/DA2605	2	2
NX-DA3203/DA3205/DA3603/DA3605	4	4
Other models	0	0

*2. The meanings of the set values for Ch□ Enable/Disable are as follows.

Set value	Meaning
FALSE	Disable
TRUE	Enable

Index (hex)	Subindex (hex)	Object name	Default value	Data range	Unit	Data type	Access	I/O allocation	Data attribute
5011	---	Output Range Setting	---	---	---	---	---	---	---
	00	Number of Entries	*1	*1	---	USINT	RO	Not possible	---
	01	Ch1 Range Setting	*2	*2	---	UINT	RW	Not possible	Y
	02	Ch2 Range Setting			---	UINT	RW	Not possible	Y
	03	Ch3 Range Setting			---	UINT	RW	Not possible	Y
	04	Ch4 Range Setting			---	UINT	RW	Not possible	Y

*1. The default value and data range for Number of Entries are as follows.

NX Units	Default value	Data range
NX-DA2203/DA2205/DA2603/DA2605	2	2
NX-DA3203/DA3205/DA3603/DA3605	4	4
Other models	0	0

*2. The default value and data range for Ch□ Range Setting are as follows.

NX Units	Set value	Meaning	Default value	Data range
NX-DA2203/DA2205/DA3203/DA3205	0	4 to 20 mA	0	0
	1	0 to 10 V		
	2	-10 to +10 V		
	3	0 to 5 V		
	4	1 to 5 V		
	5	0 to 20 mA		
NX-DA2603/DA2605/DA3603/DA3605	0	4 to 20 mA	2	2
	1	0 to 10 V		
	2	-10 to +10 V		
	3	0 to 5 V		
	4	1 to 5 V		
	5	0 to 20 mA		

Index (hex)	Subindex (hex)	Object name	Default value	Data range	Unit	Data type	Access	I/O allocation	Data attribute
5012	---	Load Rejection Output Setting	---	---	---	---	---	---	---
	00	Number of Entries	*1	*1	---	USINT	RO	Not possible	---
	01	Ch1 Hold Value Setting	4	0 to 4 *2	---	USINT	RW	Not possible	Y
	02	Ch1 User-specified Value Setting	0	-32768 to 32767	---	INT	RW	Not possible	Y
	03	Ch2 Hold Value Setting	4	0 to 4 *2	---	USINT	RW	Not possible	Y
	04	Ch2 User-specified Value Setting	0	-32768 to 32767	---	INT	RW	Not possible	Y
	05	Ch3 Hold Value Setting	4	0 to 4 *2	---	USINT	RW	Not possible	Y
	06	Ch3 User-specified Value Setting	0	-32768 to 32767	---	INT	RW	Not possible	Y
	07	Ch4 Hold Value Setting	4	0 to 4 *2	---	USINT	RW	Not possible	Y
	08	Ch4 User-specified Value Setting	0	-32768 to 32767	---	INT	RW	Not possible	Y

*1. The default value and data range for Number of Entries are as follows.

NX Units	Default value	Data range
NX-DA2203/DA2205/DA2603/DA2605	4	4
NX-DA3203/DA3205/DA3603/DA3605	8	8
Other models	0	0

*2. The meanings of the set values for Ch□ Hold Value Setting are as follows.

Set value	Meaning
0	Hold Last State
1	Low Limit
2	High Limit
3	User Count
4	Zero Count

A-4 List of Screwless Clamping Terminal Block Models

This section explains how to read the screwless clamping terminal block model numbers and shows the model number table.

A-4-1 Model Notation

The screwless clamping terminal block models are assigned based on the following rules.

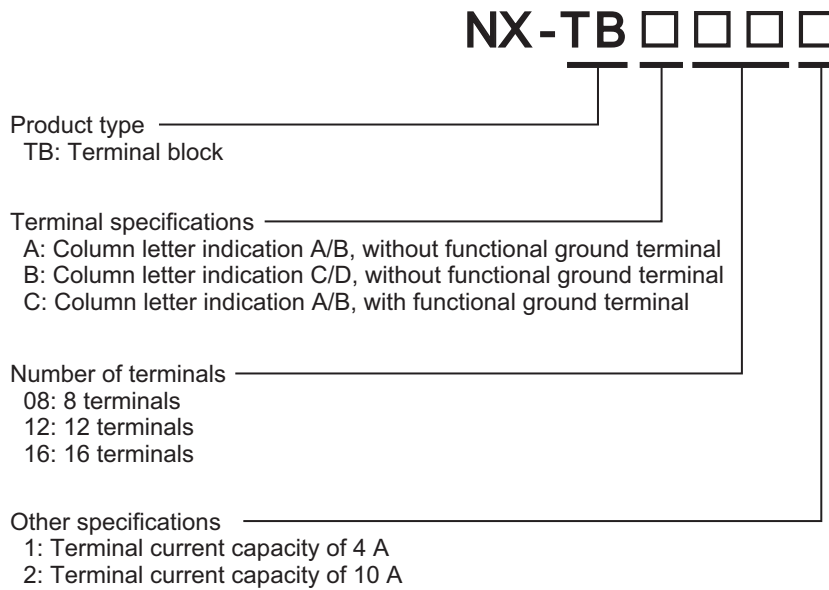

A-4-2 List of Terminal Block Models

The following table shows a list of screwless clamping terminal blocks.

Terminal block model	Number of terminals	Ground terminal mark	Terminal current capacity
NX-TBA081	8	Not provided	4 A
NX-TBA121	12		
NX-TBA161	16		
NX-TBB121	12		
NX-TBB161	16		
NX-TBA082	8		
NX-TBA122	12		
NX-TBA162	16		
NX-TBB082	8		
NX-TBB122	12		
NX-TBB162	16		
NX-TBC082	8		Provided
NX-TBC162	16		

Note When you purchase a terminal block, purchase an NX-TB□□□2.

A-5 Version Information with CPU Units

This section provides version-related information when connecting Units to a CPU Unit. This section describes the relationships between the unit versions of each Unit and the CPU Unit, and Sysmac Studio version, and the specification changes for each unit version of each Unit.

A-5-1 Relationship between Unit Versions of Units

The relationship between the unit versions of each Unit and the CPU Unit, and Sysmac Studio version are shown below.

Interpreting the Version Combination Tables

The items that are used in the version combination tables are given below.

Refer to the user's manual for the CPU Unit for the models of CPU Unit to which NX Units can be connected.

NX Unit		Corresponding unit versions/versions	
Model	Unit version	CPU Unit	Sysmac Studio
Model numbers of NX Units.	Unit versions of NX Units.	Unit versions of the CPU that are compatible with the NX Units.	Sysmac Studio versions that are compatible with the NX Units and CPU Unit.

Version Combination Tables

- With the combinations of the unit versions/versions shown below, you can use the functions that are supported by the unit version of the Unit model. Use the unit versions/versions (or the later/higher unit versions/versions) that correspond to the NX Unit models and the unit versions. You cannot use the specifications that were added or changed for the relevant NX Unit models and the unit versions unless you use the corresponding unit versions/versions.
- Depending on the type and model of the Unit to which the NX Unit is connected, some Units do not have the corresponding versions given in the table. If a Unit does not have the specified version, support is provided by the oldest available version after the specified version. Refer to the user's manuals for the specific Units for the relation between models and versions.
- If you use the corresponding unit versions/versions given in the following table or later/higher versions, refer to the version information in the user's manual for the CPU Unit.

NX Unit		Corresponding unit versions/versions	
Model	Unit version	CPU Unit	Sysmac Studio
NX-AD2203	Ver. 1.0	Ver. 1.13	Ver. 1.17
NX-AD2204			
NX-AD2208			
NX-AD2603			
NX-AD2604			
NX-AD2608			
NX-AD3203			
NX-AD3204			
NX-AD3208			
NX-AD3603			
NX-AD3604			
NX-AD3608			
NX-AD4203			
NX-AD4204			
NX-AD4208			
NX-AD4603			
NX-AD4604			
NX-AD4608			
NX-DA2203			
NX-DA2205			
NX-DA2603			
NX-DA2605			
NX-DA3203			
NX-DA3205			
NX-DA3603			
NX-DA3605			

A-6 Version Information with Communications Coupler Units

This section provides version-related information when connecting Units to a Communications Coupler Unit.

Version information is provided separately for each Communications Coupler Unit that an NX Unit is connected to.

A

A-6-1 Connection to an EtherCAT Coupler Unit

The relationship between the unit versions of each Unit, EtherCAT Coupler Unit, CPU Unit and Industrial PC, and versions of the Sysmac Studio are shown below.

Relationship between Unit Versions of Units

The items that are used in the version combination table are given below.

NX Unit		Corresponding unit versions/versions		
Model	Unit version	EtherCAT Coupler Unit	CPU Unit or Industrial PC	Sysmac Studio
Model numbers of NX Units.	Unit versions of NX Units.	Unit versions of EtherCAT Coupler Units that are compatible with the NX Units.	Unit versions of NJ/NX-series CPU Units or NY-series Industrial PCs that are compatible with the EtherCAT Coupler Units.	Sysmac Studio versions that are compatible with the NX Units, EtherCAT Coupler Units, CPU Units, and Industrial PCs.

The version combination table is given below.

- With the combinations of the unit versions/versions shown below, you can use the functions that are supported by the unit version of the Unit model. Use the unit versions/versions (or the later/higher unit versions/versions) that correspond to the NX Unit models and the unit versions. You cannot use the specifications that were added or changed for the relevant NX Unit models and the unit versions unless you use the corresponding unit versions/versions.
- Depending on the type and model of the Unit to which the NX Unit is connected, some Units do not have the corresponding versions given in the table. If a Unit does not have the specified version, support is provided by the oldest available version after the specified version. Refer to the user's manuals for the specific Units for the relation between models and versions.
- You cannot connect the relevant NX Unit to the target Communications Coupler Unit if "---" is shown in the corresponding unit versions/versions column.
- If you use the corresponding unit versions/versions given in the following table or later/higher versions, refer to the version information in the user's manual for the Communications Coupler Unit, CPU Unit, and Industrial PC.

NX Unit		Corresponding unit versions/versions		
Model	Unit Version	EtherCAT Coupler Unit	CPU Unit or Industrial PC	Sysmac Studio
NX-AD2203	Ver.1.0	Ver.1.0	Ver.1.05	Ver.1.06
NX-AD2204				
NX-AD2208				
NX-AD2603				
NX-AD2604				
NX-AD2608				
NX-AD3203				
NX-AD3204				
NX-AD3208				
NX-AD3603				
NX-AD3604				
NX-AD3608				
NX-AD4203				
NX-AD4204				
NX-AD4208				
NX-AD4603				
NX-AD4604				
NX-AD4608				
NX-DA2203				
NX-DA2205				
NX-DA2603				
NX-DA2605				
NX-DA3203				
NX-DA3205				
NX-DA3603				
NX-DA3605				

A-6-2 Connection to an EtherNet/IP Coupler Unit

The relationship between the unit versions of each Unit, EtherNet/IP Coupler Unit, CPU Unit and Industrial PC, and versions of the Sysmac Studio and NX-IO Configurator are shown below.

Relationship between Unit Versions of Units

The items that are used in the version combination tables are given below.

NX Unit		Corresponding unit versions/versions					
Model	Unit version	Application with an NJ/NX/NY-series Controller			Application with a CS/CJ/CP-series PLC		
		EtherNet/IP Coupler Unit	CPU Unit or Industrial PC	Sysmac Studio	EtherNet/IP Coupler Unit	Sysmac Studio	NX-IO Configurator
Model number of NX Unit	Unit version of the NX Unit	Unit version of EtherNet/IP Coupler Unit that is compatible with the NX Unit	Unit version of NJ/NX-series CPU Unit or NY-series Industrial PC that is compatible with the EtherNet/IP Coupler Unit	Sysmac Studio version that is compatible with the NX Unit, EtherNet/IP Coupler Unit, CPU Unit, and Industrial PC	Unit version of EtherNet/IP Coupler Unit that is compatible with the NX Unit	Sysmac Studio version that is compatible with the NX Unit, EtherNet/IP Coupler Unit, and CPU Unit	NX-IO Configurator version that is compatible with the NX Unit, EtherNet/IP Coupler Unit, and CPU Unit

The version combination table is given below.

- With the combinations of the unit versions/versions shown below, you can use the functions that are supported by the unit version of the Unit model. Use the unit versions/versions (or the later/higher unit version/versions) that correspond to the NX Unit models and the unit versions. You cannot use the specifications that were added or changed for the relevant NX Unit models and the unit versions unless you use the corresponding unit versions/versions.
- Depending on the type and model of the Unit to which the NX Unit is connected, some Units do not have the corresponding versions given in the table. If a Unit does not have the specified version, support is provided by the oldest available version after the specified version. Refer to the user's manuals for the specific Units for the relation between models and versions.
- You cannot connect the relevant NX Unit to the target Communications Coupler Unit if "----" is shown in the corresponding unit versions/versions column.
- If you use the corresponding unit versions/versions given in the following table or later/higher versions, refer to the version information in the user's manual for the Communications Coupler Unit, CPU Unit, and Industrial PC.

NX Unit		Corresponding unit versions/versions					
Model	Unit version	Application with an NJ/NX/NY-series Controller *1			Application with a CS/CJ/CP-series PLC *2		
		EtherNet/IP Coupler Unit	CPU Unit or Industrial PC	Sysmac Studio	EtherNet/IP Coupler Unit	Sysmac Studio	NX-IO Configurator *3
NX-AD2203	Ver. 1.0	Ver. 1.2	Ver. 1.14	Ver. 1.19	Ver. 1.0	Ver. 1.10	Ver. 1.00
NX-AD2204							
NX-AD2208							
NX-AD2603							
NX-AD2604							
NX-AD2608							
NX-AD3203							
NX-AD3204							
NX-AD3208							
NX-AD3603							
NX-AD3604							
NX-AD3608							
NX-AD4203							
NX-AD4204							
NX-AD4208							
NX-AD4603							
NX-AD4604							
NX-AD4608							
NX-DA2203							
NX-DA2205							
NX-DA2603							
NX-DA2605							
NX-DA3203							
NX-DA3205							
NX-DA3603							
NX-DA3605							

*1. Refer to the user's manual for the EtherNet/IP Coupler Units for information on the unit versions of EtherNet/IP Units that are compatible with EtherNet/IP Coupler Units.

*2. Refer to the user's manual for the EtherNet/IP Coupler Units for information on the unit versions of CPU Units and EtherNet/IP Units that are compatible with EtherNet/IP Coupler Units.

*3. For connection to an EtherNet/IP Coupler Unit with unit version 1.0, connection is supported only for a connection to the peripheral USB port on the EtherNet/IP Coupler Unit. You cannot connect by any other path. If you need to connect by another path, use an EtherNet/IP Coupler Unit with unit version 1.2 or later.

A-7 Version Information with Communication Control Units

This section provides version-related information when connecting Units to a Communication Control Unit. This section describes the relationship between the unit versions of each Unit and the Communication Control Unit, and Sysmac Studio version, and the specification changes for each unit version of each Unit.

A-7-1 Relationship between Unit Versions of Units

The relationship between the unit versions of each Unit and the Communication Control Unit, and Sysmac Studio version are shown below.

Interpreting the Version Combination Table

The items that are used in the version combination tables are given below.

NX Units		Corresponding unit versions/versions	
Model	Unit version	Communication Control Unit	Sysmac Studio
Model number of NX Unit	Unit versions of the NX Units	Unit versions of the Communication Control Unit that are compatible with the NX Units	Sysmac Studio versions that are compatible with the NX Units and Communication Control Unit

Version Combination Tables

- With the combinations of the unit versions/versions shown below, you can use the functions that are supported by the unit version of the Unit model. Use the unit versions/versions (or the later/higher unit version/versions) that correspond to the NX Unit models and the unit versions. You cannot use the specifications that were added or changed for the relevant NX Unit models and the unit versions unless you use the corresponding unit versions/versions.
- Depending on the type and model of the Unit to which the NX Unit is connected, some Units do not have the corresponding versions given in the table. If a Unit does not have the specified version, support is provided by the oldest available version after the specified version. Refer to the user's manuals for the specific Units for the relation between models and versions.
- You cannot connect the relevant NX Unit to the Communication Control Unit if "---" is shown in the corresponding unit versions/versions column.
- If you use the corresponding unit versions/versions given in the following table or later/higher versions, refer to the version information in the user's manual for the Communication Control Unit.

NX Unit		Corresponding unit versions/ versions	
Model	Unit version	Communication Control Unit	Sysmac Studio
NX-AD2203	Ver.1.0	Ver.1.00	Ver.1.24
NX-AD2204			
NX-AD2208			
NX-AD2603			
NX-AD2604			
NX-AD2608			
NX-AD3203			
NX-AD3204			
NX-AD3208			
NX-AD3603			
NX-AD3604			
NX-AD3608			
NX-AD4203			
NX-AD4204			
NX-AD4208			
NX-AD4603			
NX-AD4604			
NX-AD4608			
NX-DA2203			
NX-DA2205			
NX-DA2603			
NX-DA2605			
NX-DA3203			
NX-DA3205			
NX-DA3603			
NX-DA3605			

A-8 Displaying the Edit Unit Operation Settings Tab Page

A

A-8-1 Connection to the CPU Unit or the Communication Control Unit

This section describes how to display the Edit Unit Operation Settings Tab Page that is used to create Unit operation settings on the Sysmac Studio for the NX Units connected to the CPU Unit or Communication Control Unit.

You can use the methods described below to display the Edit Unit Operation Settings Tab Page on the CPU and Expansion Racks Tab Page for the CPU Unit or Communication Control Unit on the Sysmac Studio.

Refer to the *Sysmac Studio Version 1 Operation Manual* (Cat. No. W504) for the method of displaying the CPU and Expansion Racks Tab Page.

● Method 1

Double-click the NX Unit to set.

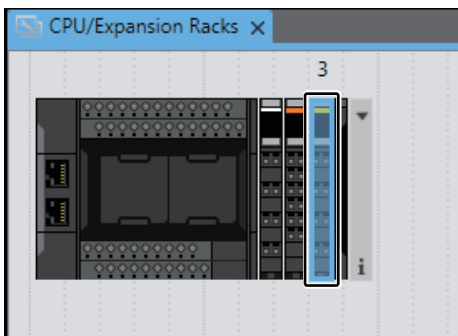

● Method 2

Right-click the NX Unit and select **Edit Unit Operation Settings** from the menu.

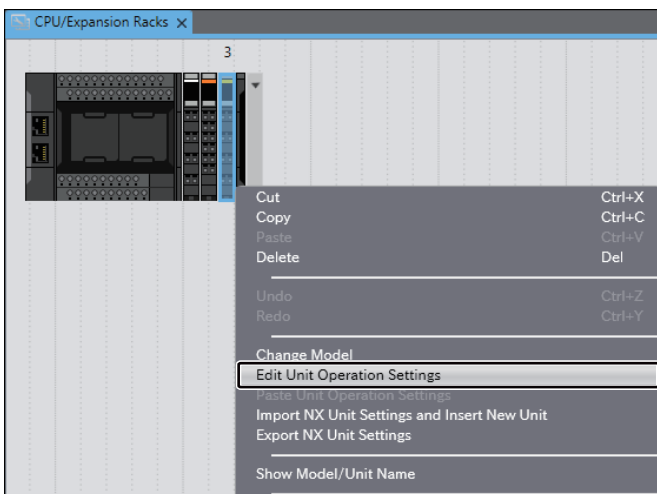

● **Method 3**

Select the NX Unit and click the **Edit Unit Operation Settings** Button.

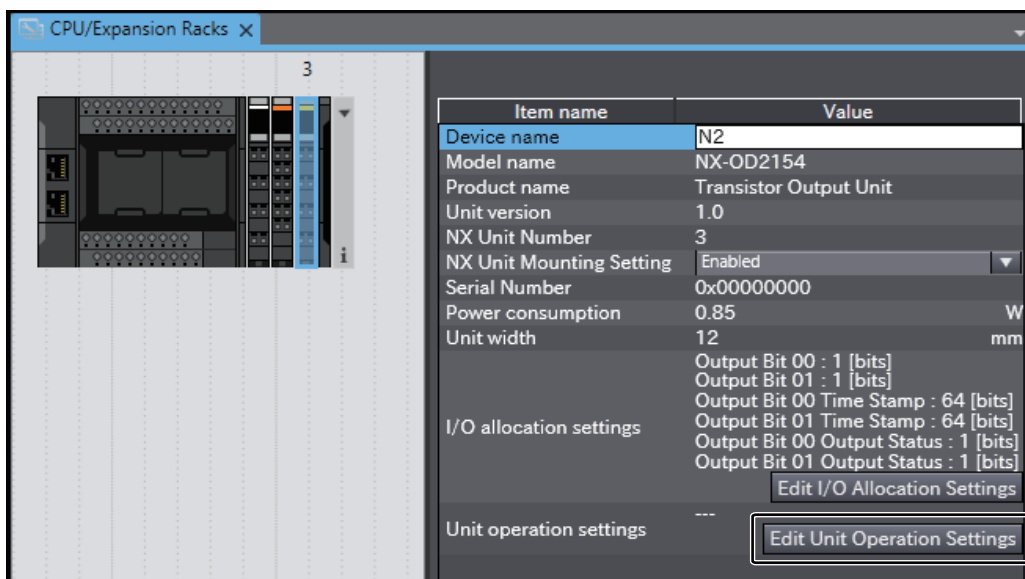

A-8-2 Slave Terminal

This section describes how to display the Edit Unit Operation Settings Tab Page that is used to create Unit operation settings on the Sysmac Studio for NX Units in the Slave Terminal.

You can use the methods described below to display the Edit Unit Operation Settings Tab Page on the Edit Slave Terminal Configuration Tab Page on the Sysmac Studio.

Refer to the *Sysmac Studio Version 1 Operation Manual* (Cat. No. W504) for the method of displaying the Edit Slave Terminal Configuration Tab Page.

Refer to the operation manual for the Support Software that you are using for the method of displaying the Edit Slave Terminal Configuration Tab Page or Edit Unit Operation Settings Tab Page with Support Software other than Sysmac Studio.

● Method 1

Double-click the NX Unit to set.

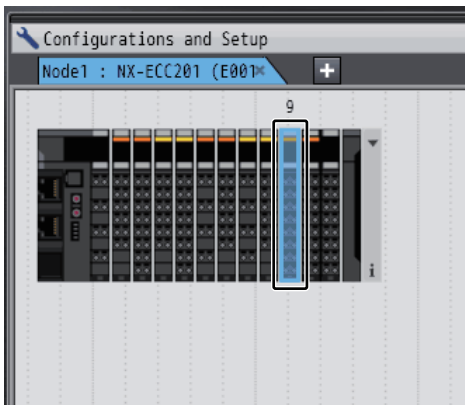

● Method 2

Right-click the NX Unit and select **Edit Unit Operation Settings** from the menu.

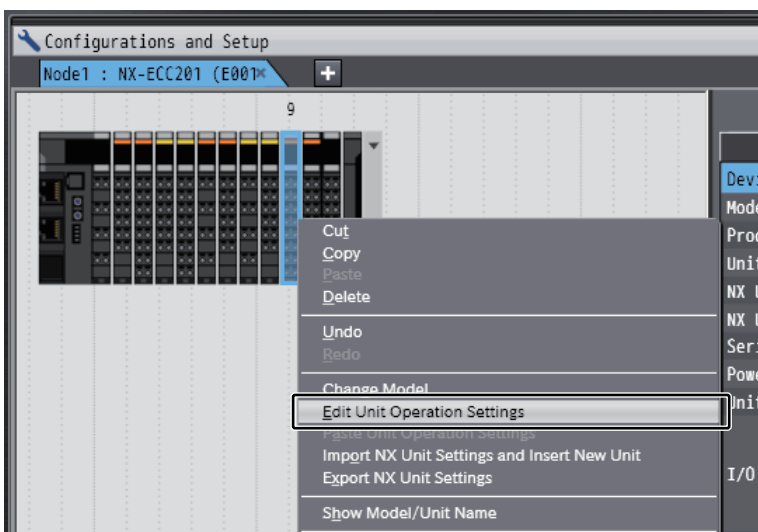

● **Method 3**

Select the NX Unit and click the **Edit Unit Operation Settings** Button.

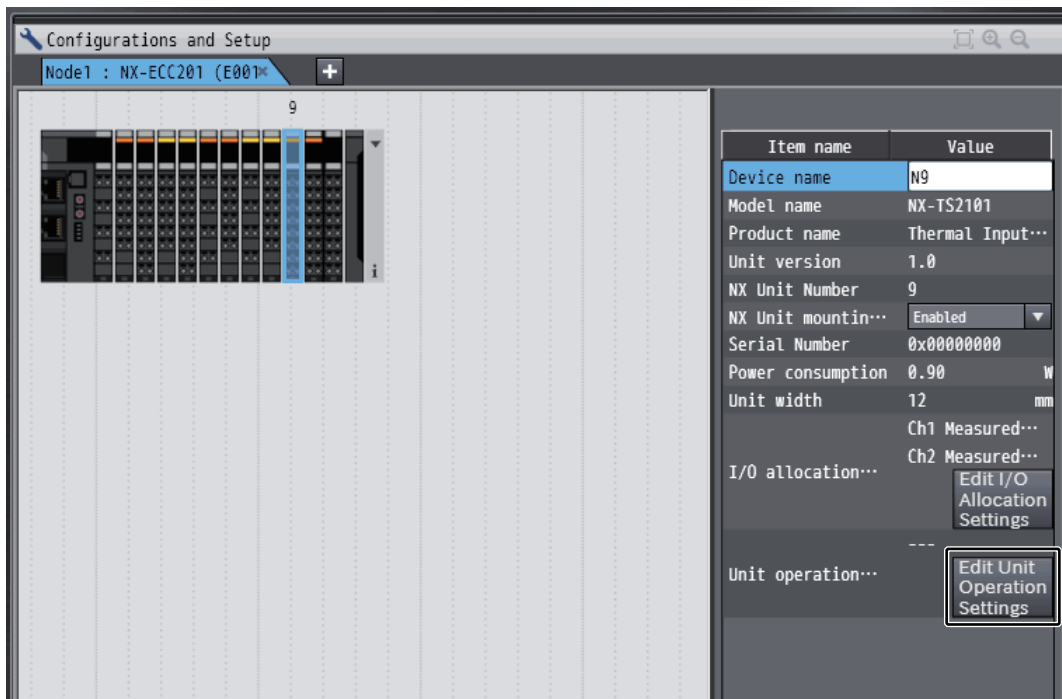



Index



Index

Numerics

12 mm Width	3-2
32767	6-5

A

Access	A-39
Additional I/O Power Supply Unit	4-10
Additional NX Unit Power Supply Unit	4-10
Applicable Wire	4-13
Assumed cause	8-7

B

built-in EtherCAT port	9
------------------------------	---

C

Coding Pin	4-25
Communication Control Unit	1-7
Communications Coupler Unit	1-5
Communications Master Unit	5-3
Correctable Range	6-26, 7-21
CPU Rack	1-2, 1-5, 1-8
CPU Unit	5-3
crimping tool	4-14
Current Error	8-5

D

Data attribute	A-39
Data range	A-39
Data type	A-39
DC enable	5-8
Default value	A-39
Differential	4-29
DIN Track mounting hook	3-2

E

Event code	8-7
Event name	8-7

F

Ferrule	4-14
---------------	------

G

Ground terminal	4-14, 4-15
-----------------------	------------

H

High Limit	7-14
Hold Last State	7-14

I

I/O allocation	A-39
I/O allocation setting	6-6, 7-5
I/O entry	6-6, 7-5
I/O entry mapping	6-6, 7-5
I/O Map	4-28
I/O power supply	4-9
I/O Power Supply Connection Unit	4-10
I/O power supply terminal	4-9
incorrect attachment prevention hole	4-25
Index	A-39
Indicator	3-2
Industrial PC	8

L

Log of Past Error	8-6
Low Limit	7-14

M

Marker	4-4
Marker attachment location	3-2
maximum current of I/O power supply	4-11
maximum I/O power supply current	4-11
Model number indication	3-6

N

NX bus connector	3-2
NX Object	A-39
NX Unit power supply	4-9

O

Object name	A-39
Objects That Accept I/O Allocations	A-41, A-50
Other Objects	A-42, A-51

P

Periodic Inspection Item	9-3
Preventing Incorrect Attachment	4-25
Protrusions for removing the Unit	3-2

R

range for which conversion is possible 6-4, 6-24, 7-3, 7-19
refresh cycle of the NX bus 5-2, 5-3
Release hole 3-4

S

securing wire 4-20
shield 4-30
Shield Connection Unit 4-30
Single-ended 4-29
Slave Terminal 1-2, 1-5
Solid Wire 4-15
Subindex A-39
supply from external source 4-10
supply from the NX bus 4-9
Sync0 5-15, 5-19
synchronization timing 5-13, 5-17

T

Terminal block 3-2, 3-3
Terminal hole 3-4
Terminal number indication 3-4
timing to read inputs 5-9, 5-11, 5-13, 5-15
timing to refresh outputs 5-9, 5-11, 5-17, 5-19
Twisted Wire 4-15

U

Unit A-39
Unit hookup guide 3-2
Unit Information Object A-40, A-49
Unit specifications 3-2
User Count 7-14

W

Watch Tab Page 4-28
Wiring Terminal 4-12

Z

Zero Count 7-14

OMRON Corporation Industrial Automation Company
Kyoto, JAPAN

Contact: www.ia.omron.com

Regional Headquarters

OMRON EUROPE B.V.

Wegalaan 67-69, 2132 JD Hoofddorp
The Netherlands
Tel: (31)2356-81-300/Fax: (31)2356-81-388

OMRON ELECTRONICS LLC

2895 Greenspoint Parkway, Suite 200
Hoffman Estates, IL 60169 U.S.A.
Tel: (1) 847-843-7900/Fax: (1) 847-843-7787

OMRON ASIA PACIFIC PTE. LTD.

No. 438A Alexandra Road # 05-05/08 (Lobby 2),
Alexandra Technopark,
Singapore 119967
Tel: (65) 6835-3011/Fax: (65) 6835-2711

OMRON (CHINA) CO., LTD.

Room 2211, Bank of China Tower,
200 Yin Cheng Zhong Road,
PuDong New Area, Shanghai, 200120, China
Tel: (86) 21-5037-2222/Fax: (86) 21-5037-2200

Authorized Distributor:

© OMRON Corporation 2013-2018 All Rights Reserved.
In the interest of product improvement,
specifications are subject to change without notice.

Cat. No. W522-E1-10

1018