



CJ Series
EtherNet/IP™ Connection Guide

OMRON Corporation
NX-series
EtherNet/IP Coupler Unit

About Intellectual Property Rights and Trademarks

Microsoft product screen shots reprinted with permission from Microsoft Corporation.

Windows is a registered trademark of Microsoft Corporation in the USA and other countries.

ODVA and EtherNet/IP™ are trademarks of ODVA.

Sysmac is a trademark or registered trademark of OMRON Corporation in Japan and other countries for OMRON factory automation products.

Company names and product names in this document are the trademarks or registered trademarks of their respective companies.

Table of Contents

1. Related Manuals	1
2. Terms and Definitions	2
3. Precautions	3
4. Overview	4
5. Applicable Devices and Device Configuration	5
5.1. Applicable Devices	5
5.2. Device Configuration	6
6. EtherNet/IP Settings	8
6.1. Parameters	8
6.2. Slave Terminal Configuration	8
6.3. Tag Data Link Settings.....	9
7. EtherNet/IP Connection Procedure	10
7.1. Work Flow	10
7.2. Slave Terminal Setup.....	12
7.3. PLC Setup	21
7.4. Network Settings	30
7.5. EtherNet/IP Communication Status Check	42
8. Initialization Method	48
8.1. Initializing PLC	48
8.2. Initialization of Slave Terminal	49
9. Revision History	50

1. Related Manuals

To ensure system safety, make sure to always read and follow the information provided in all Safety Precautions and Precautions for Safe Use in the manuals for each device which is used in the system.

Cat. No.	Model	Manual name
W472	CJ2M-CP□□ CJ2H-CPU6□ CJ2H-CPU6□-EIP	CJ-series CJ2 CPU Unit Hardware USER'S MANUAL
W473	CJ2M-CPU□□ CJ2H-CPU6□ CJ2H-CPU6□-EIP	CJ-series CJ2 CPU Unit Software USER'S MANUAL
W465	CJ1W-EIP21 CJ2M-CPU3□ CJ2H-CPU6□-EIP	CJ Series EtherNet/IP™ Units OPERATION MANUAL
W446	CXONE-AL□□C-V4 / AL□□D-V4	CX-Programmer OPERATION MANUAL
0969584-7	W4S1-05□ W4S1-03B	Switching Hub W4S1-series Users Manual
W504	SYSMAC-SE2□□□□	Sysmac Studio Version 1 Operation Manual
W536	NX-EIC□□□	NX-series EtherNet/IP™ Coupler Unit User's Manual
W521	NX-ID□□□□ NX-IA□□□□ NX-OC□□□□ NX-OD□□□□ NX-MD□□□□	NX-series Digital I/O Units User's Manual
W522	NX-AD□□□□ NX-DA□□□□ NX-TS□□□□	NX-series Analog I/O Units User's Manual
W523	NX-PD1□□□ NX-PF0□□□ NX-PC0□□□ NX-TBX01	NX-series System Units User's Manual
W540	NX-CIF□□□	NX-series Communications Interface Units User's Manual
W524	NX-EC0□□□ NX-ECS□□□ NX-PG0□□□	NX-series Position Interface Units User's Manual
Z930	NX-SL□□□□ NX-SI□□□□ NX-SO□□□□	NX-series Safety Control Unit User's Manual

2. Terms and Definitions

Term	Explanation and Definition
Node	<p>A programmable controller and a device are connected to an EtherNet/IP network via EtherNet/IP ports. EtherNet/IP recognizes each EtherNet/IP port connected to the network as one node.</p> <p>When a device with two EtherNet/IP ports is connected to the EtherNet/IP network, EtherNet/IP recognizes this device as two nodes. EtherNet/IP achieves the communications between programmable controllers or the communications between a programmable controller and a device by exchanging data between these nodes connected to the network.</p>
Tag	<p>A minimum unit of the data that is exchanged on the EtherNet/IP network is called a tag. The tag is defined as a network variable or as a physical address, and it is assigned to the memory area of each device.</p>
Tag set	<p>In the EtherNet/IP network, a data unit that consists of two or more tags can be exchanged. The data unit consisting of two or more tags for the data exchange is called a tag set. Up to eight tags can be configured per tag set for the programmable controllers produced by OMRON Corporation.</p>
Tag data link	<p>In EtherNet/IP, the tag and tag set can be exchanged cyclically between nodes without using a user program.</p> <p>This standard feature on EtherNet/IP is called a tag data link.</p>
Connection	<p>A connection is used to exchange data as a unit within which data concurrency is maintained. The connection consists of tags or tag sets. Creating the concurrent tag data link between the specified nodes is called a "connection establishment". When the connection is established, the tags or tag sets that configure the connection are exchanged between the specified nodes concurrently.</p>
Connection type	<p>There are two kinds of connection types for the tag data link connection. One is a multi-cast connection, and the other is a unicast (point-to-point) connection. The multi-cast connection sends an output tag set in one packet to more than one node. The unicast connection separately sends one output tag set to each node. Therefore, multi-cast connections can decrease the communications load if one output tag set is sent to more than one node.</p>
Originator and Target	<p>To operate tag data links, one node requests the opening of a communications line called a "connection".</p> <p>The node that requests to open the connection is called an "originator", and the node that receives the request is called a "target".</p>
Tag data link parameter	<p>A tag data link parameter is the setting data to operate tag data links. It includes the data to set tags, tag sets, and connections.</p>

3. Precautions

- (1) Understand the specifications of devices which are used in the system. Allow some margin for ratings and performance. Provide safety measures, such as installing a safety circuit, in order to ensure safety and minimize the risk of abnormal occurrence.
- (2) To ensure system safety, make sure to always read and follow the information provided in all Safety Precautions and Precautions for Safe Use in the manuals for each device which is used in the system.
- (3) The user is encouraged to confirm the standards and regulations that the system must conform to.
- (4) It is prohibited to copy, to reproduce, and to distribute a part or the whole of this document without the permission of OMRON Corporation.
- (5) The information contained in this document is current as of July 2016. It is subject to change for improvement without notice.

The following notations are used in this document.



Indicates a potentially hazardous situation which, if not avoided, may result in minor or moderate injury or property damage.



Precautions for Correct Use

Precautions on what to do and what not to do to ensure proper operation and performance.



Additional Information

Additional information to read as required.

This information is provided to increase understanding or make operation easier.

Symbol



The triangle symbol indicates precautions (including warnings).
The specific operation is shown in the triangle and explained in the text.
This example indicates a general precaution.



The filled circle symbol indicates operations that you must do.
The specific operation is shown in the circle and explained in the text.
This example shows a general precaution for something that you must do.

4. Overview

This document describes the procedures for connecting NX-series EtherNet/IP Coupler Unit (hereinafter referred to as Coupler Unit) + NX-series various types of Units to CJ-series Programmable Controller + EtherNet/IP Unit (hereinafter referred to as PLC) via EtherNet/IP, both produced by OMRON Corporation (hereinafter referred to as OMRON), and for checking their communication status.

In this document, the connection status is checked with an EtherNet/IP slave (hereinafter referred to as Slave Terminal) that is created by mounting I/O Units to Coupler Unit.

Refer to *Section 6. EtherNet/IP Settings* and *Section 7. EtherNet/IP Connection Procedure* to understand setting methods and key points to operate EtherNet/IP tag data links.

In this document, CJ-series EtherNet/IP Unit and the built-in EtherNet/IP port of CJ-series CJ2 CPU Unit are collectively called as "EtherNet/IP Unit".

5. Applicable Devices and Device Configuration

5.1. Applicable Devices

The applicable devices are as follows:

Manufacturer	Name	Model
OMRON	CJ2 CPU Unit	CJ2[]-CPU[]
OMRON	EtherNet/IP Unit	CJ1W-EIP21 CJ2H-CPU6[]-EIP CJ2M-CPU3[]
OMRON	NX-series EtherNet/IP™ Coupler Unit	NX-EIC[]
OMRON	NX-series Units DC Input Unit AC Input Unit Relay Output Unit Transistor Output Unit Digital Mixed I/O Unit Analog Input Unit Analog Output Unit Temperature Input Unit Heater Burnout Detect Unit Communications Interface Unit System Unit Load Cell Input Unit Incremental Encoder Input Unit SSI Input Unit Pulse Output Unit Safety CPU Unit Safety Input Unit Safety Output Unit	NX-ID[] NX-IA[] NX-OC[] NX-OD[] NX-MD[] NX-AD[] NX-DA[] NX-TS[] NX-HB[] NX-CIF[] NX-PC0[] NX-RS[] NX-EC0[] NX-ECS[] NX-PG0[] NX-SL[] NX-SI[] NX-SO[]



Precautions for Correct Use

In this document, the devices with models and versions listed in 5.2. *Device Configuration* are used as examples of applicable devices to describe the procedures for connecting the devices and checking their connections.

You cannot use devices with versions lower than the versions listed in 5.2.

To use the above devices with models not listed in 5.2. or versions higher than those listed in 5.2., check the differences in the specifications by referring to the manuals before operating the devices.



Additional Information

This document describes the procedures for establishing the network connections.

It does not provide information on operation, installation, wiring method, device functionality, or device operation, which is not related to the connection procedures.

Refer to the manuals or contact your OMRON representative.

5.2. Device Configuration

The hardware components to reproduce the connection procedures in this document are as follows:

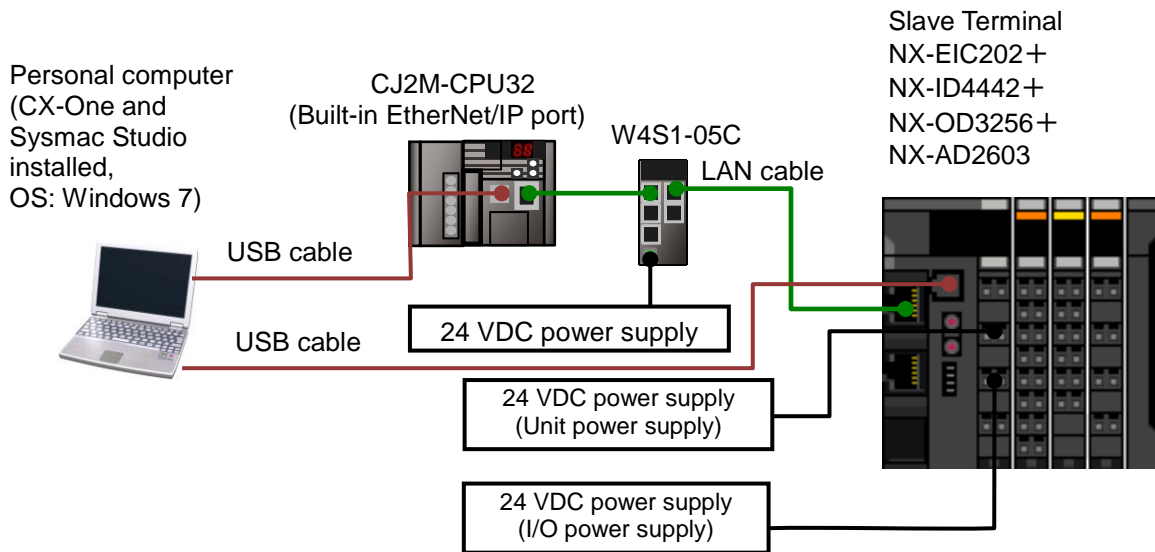

Manufacturer	Name	Model	Version
OMRON	CJ2 CPU Unit (Built-in EtherNet/IP port)	CJ2M-CPU32	Ver.2.0 (Ver.2.12)
OMRON	Power Supply Unit	CJ1W-PA202	
OMRON	Switching hub	W4S1-05C	Ver.1.00
-	24 VDC power supply (for Switching hub)	-	
OMRON	CX-One	CXONE-AL[C-V4 /AL[D-V4	Ver.4.[[]]
OMRON	CX-Programmer	(Included in CX-One)	Ver.9.60
OMRON	Network Configurator	(Included in CX-One)	Ver.3.59a
-	Personal computer (OS: Windows 7)	-	
-	USB cable (USB 2.0 type B connector)	-	
-	LAN cable (STP (shielded, twisted-pair) cable of Ethernet category 5 or higher)	-	
OMRON	Coupler Unit	NX-EIC202	Ver.1.0
OMRON	Digital Input Unit (DC Input Unit)	NX-ID4442	Ver.1.0
OMRON	Digital Output Unit (Transistor Output Unit)	NX-OD3256	Ver.1.0
OMRON	Analog Input Unit (Voltage Input Unit)	NX-AD2603	Ver.1.0
OMRON	Sysmac Studio	SYSMAC-SE2[[]]	Ver.1.15
-	24 VDC power supply (Unit power supply)	-	
-	24 VDC power supply (I/O power supply)	-	



Precautions for Correct Use

Update CX-Programmer and Network Configurator to the versions specified in this *Clause 5.2.* or to higher versions. If you use a version higher than the one specified, the procedures and related screenshots described in *Section 7.* and subsequent sections may not be applicable. In that case, use the equivalent procedures described in this document by referring the *CX-Programmer OPERATION MANUAL* (Cat. No. W446) and *Network Configurator Online Help*.



Precautions for Correct Use

Update Sysmac Studio to the version specified in this *Clause 5.2.* or to a higher version. If you use a version higher than the one specified, the procedures and related screenshots described in *Section 7.* and subsequent sections may not be applicable. In that case, use the equivalent procedures described in this document by referring to the *Sysmac Studio Version 1 Operation Manual* (Cat. No. W504).



Additional Information

For specifications of 24 VDC power supply available for Switching hub, refer to the *Switching Hub W4S1-series Users Manual* (Cat. No. 0969584-7).



Additional Information

For specifications of 24 VDC power supply (unit power supply and the I/O power supply), refer to the *NX-series EtherNet/IP™ Coupler Unit User's Manual* (Cat. No. W536).



Additional Information

The system configuration in this document uses USB for the connection between Personal computer and PLC. For information on how to install the USB driver, refer to *A-5 Installing the USB Driver of the CJ-series CJ2 CPU Unit Hardware User's Manual* (Cat. No. W472).



Additional Information

The system configuration in this document uses USB for the connection between Personal computer and Coupler Unit. For information on how to install the USB driver, refer to *A-1 Driver Installation for Direct USB Cable Connection* in *Appendices* of the *Sysmac Studio Version 1 Operation Manual* (Cat. No. W504).

6. EtherNet/IP Settings

This section describes the contents of the parameter and tag data link settings that are all defined in this document.

6.1. Parameters

The parameters required for connecting PLC to Slave Terminal via EtherNet/IP are shown below.

Item	PLC (Node 1)	Slave Terminal (Node 2)
IP address	192.168.250.1	192.168.250.2
Subnet mask	255.255.255.0	255.255.255.0
Network interface setting	-	Enable tag data links

6.2. Slave Terminal Configuration

The Slave Terminal configuration to use in this document is shown below.

Use the configuration described here when you perform 7.2.2. *Parameter Settings*.

NX Unit number	Model	Name
0	NX-EIC202	Coupler Unit
1	NX-ID4442	Digital Input Unit
2	NX-OD3256	Digital Output Unit
3	NX-AD2603	Analog Input Unit

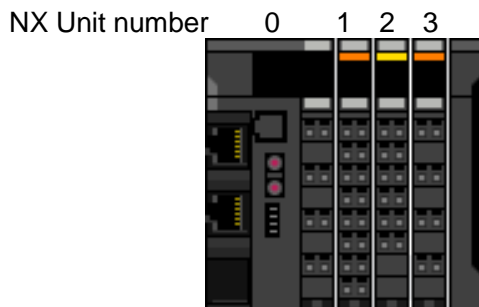

6.3. Tag Data Link Settings

The following shows the content of the tag data link settings for Slave Terminal.

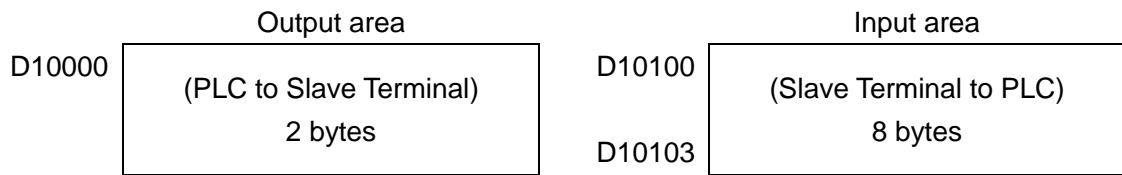

■Output area

Address	Bit	Function name
D10000	0 to 3	Digital Output 0 to 3
	4 to 15	-

■Input area

Address	Bit	Function name
D10100	0 to 3	-
	4	Slave Terminal Observation
	5	Slave Terminal Minor Fault
	6	Slave Terminal Partial Fault
	7	Slave Terminal Major Fault
	8 to 13	-
	14	Error Detection Flag
	15	I/O Refresh Flag
D10101	0 to 7	Digital Input 0 to 7
	8 to 15	-
D10102	0 to 15	Ch1 Analog Input Value
D10103	0 to 15	Ch2 Analog Input Value

7. EtherNet/IP Connection Procedure

This section describes the procedures for connecting PLC and Slave Terminal on the EtherNet/IP network.

The explanations of procedures for setting up PLC and Slave Terminal given in this document are based on the factory default settings.

For the initialization, refer to *Section 8. Initialization Method*.

7.1. Work Flow

Take the following steps to operate tag data links by connecting PLC and Slave Terminal via EtherNet/IP.

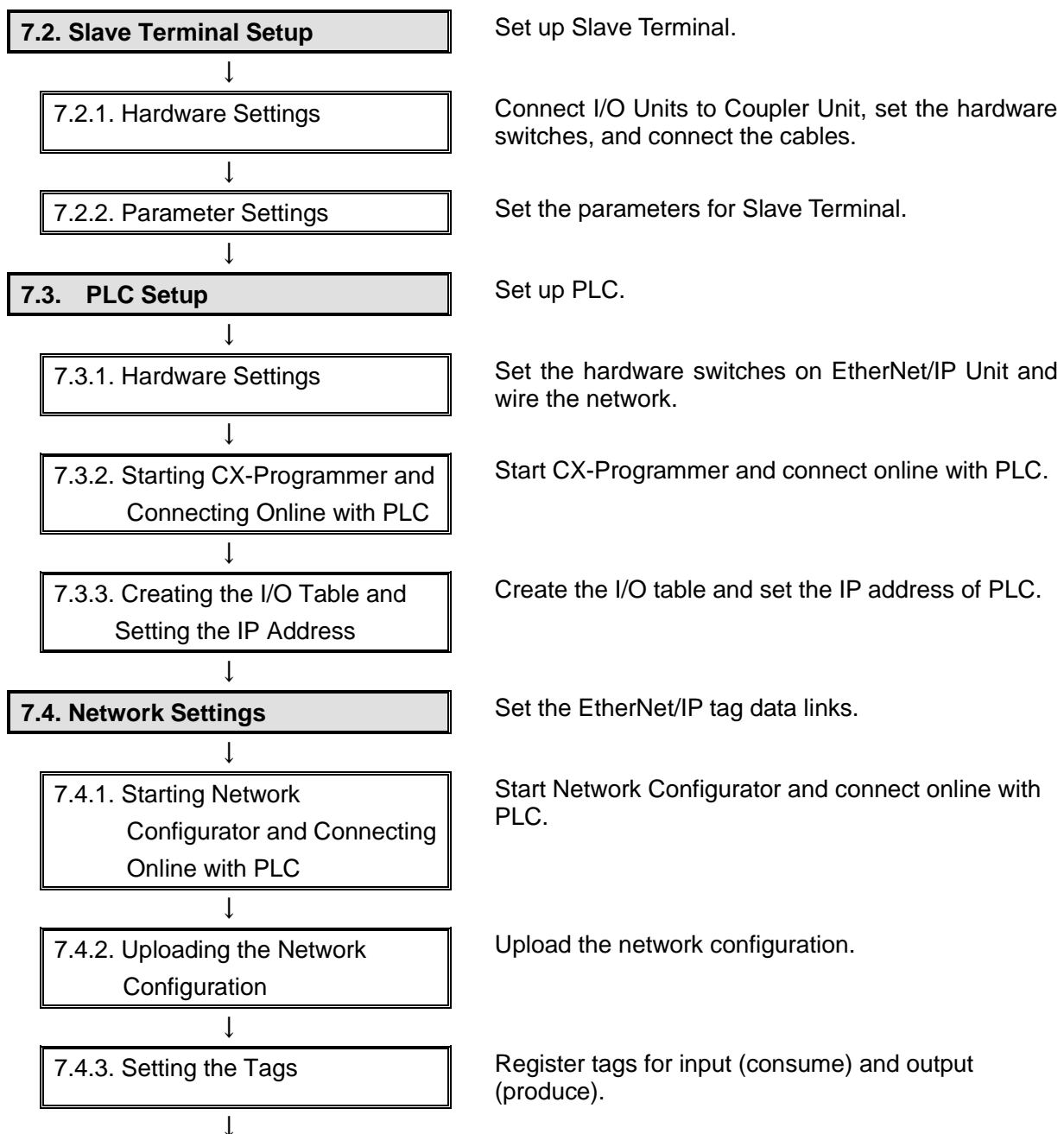

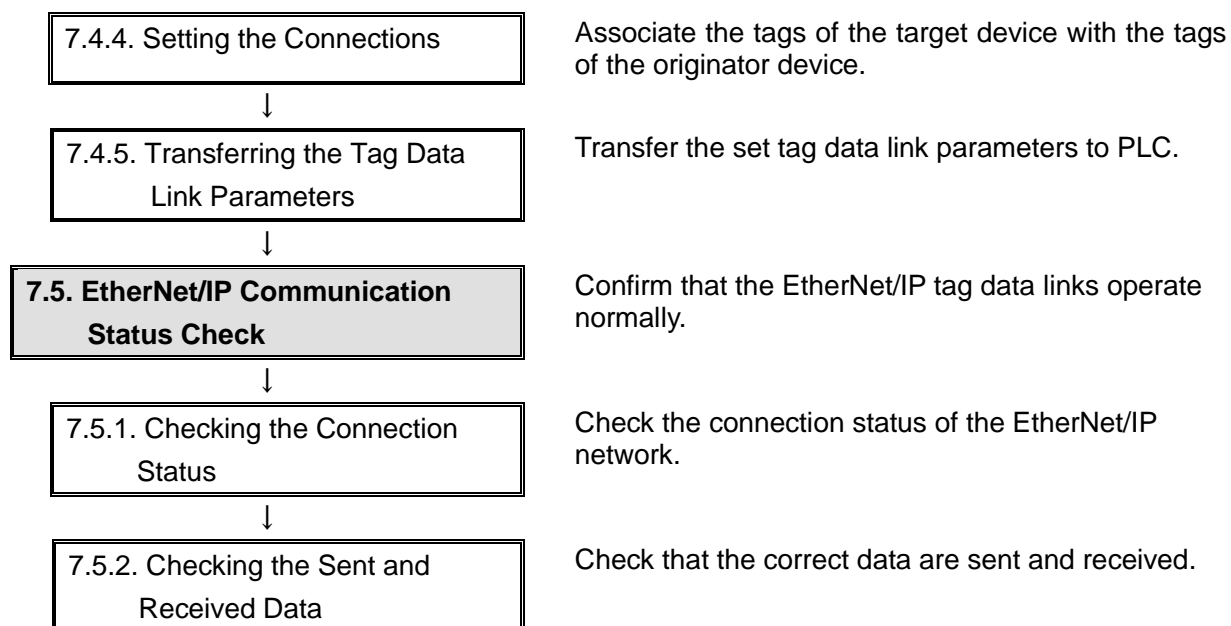

7.2. Slave Terminal Setup

Set up Slave Terminal.

7.2.1. Hardware Settings

Connect I/O Units to Coupler Unit, set the hardware switches, and connect the cables.



Precautions for Correct Use

Make sure that the power supply is OFF when you set up.

- 1 Make sure that Coupler Unit is powered OFF.

*If it is ON, the settings described in the following steps and subsequent procedures may not be applicable.

- 2 Connect each Unit to Coupler Unit by referring to 6.2. *Slave Terminal Configuration*.

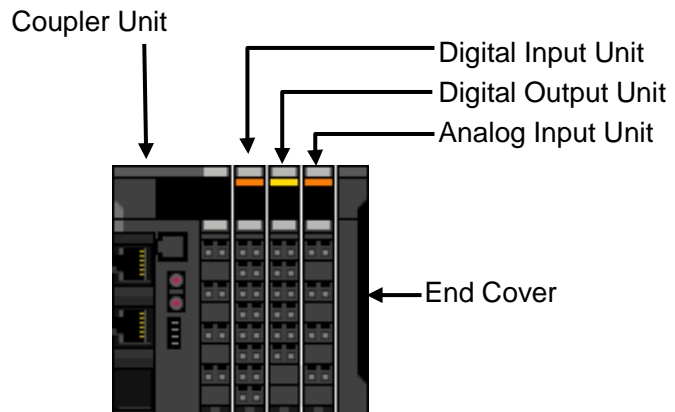

- 3 Check the positions of the hardware switches and the connectors on Coupler Unit by referring to the figure on the right.

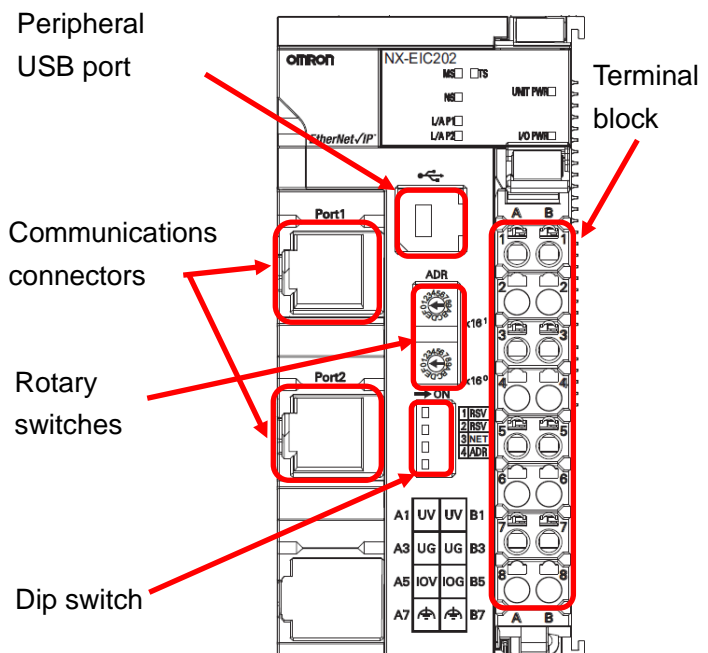

4 Check that DIP switch is set as follows:

Pin 3 NET (Network interface setting): OFF (Enable tag data links)

Pin 4 ADR (IP address base setting): OFF (The first to third octets of the IP address is 192.168.250.)

*Set the last octet of the IP address using Rotary switches.

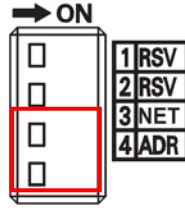

Pin	Name	Meaning
Pin 1	Reserved by the system	Keep turned OFF (The factory setting is OFF)
Pin 2		
Pin 3	Network interface setting	ON: Enable UDP/IP communications and TCP/IP communications (disable Tag Data Links) OFF: Enable Tag Data Links (disable UDP/IP communications and TCP/IP communications)
Pin 4	IP address base setting	ON: 192.168.1. [] (with [] set by rotary switches) OFF: 192.168.250. [] (with [] set by rotary switches)

5 Set Rotary switches as follows:

ADR No.x16¹: 0

ADR No.x16⁰: 2

*The IP address is set to 192.168.250.2.

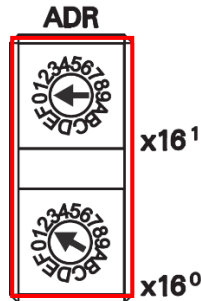

6 Connect OUT0 on Digital Output Unit to IN0 on Digital Input Unit.

*The I/O power supply (IOG and IOV) for Digital Input Unit and Digital Output Unit is not required to connect in the configuration described in this document owing to the short circuit of the I/O power supply (IOG and IOV) occurred within Slave Terminal.

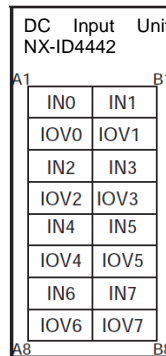

Digital Input Unit

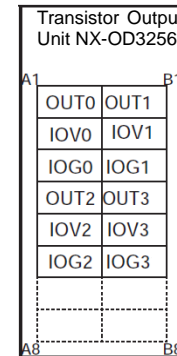
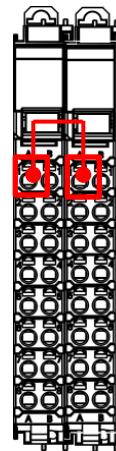

Digital Output Unit

7 Connect Communications connector (Port 1) to Switching hub with a LAN cable.

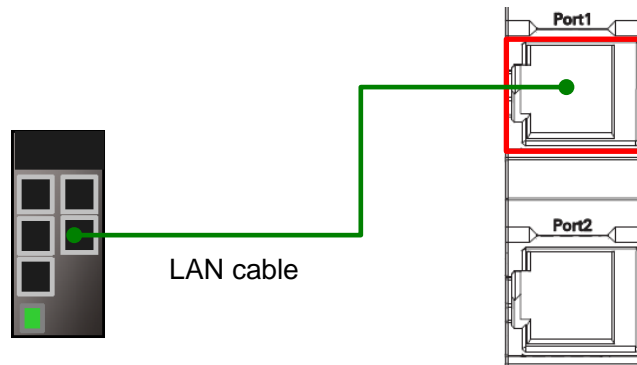

Switching hub

Communications connectors

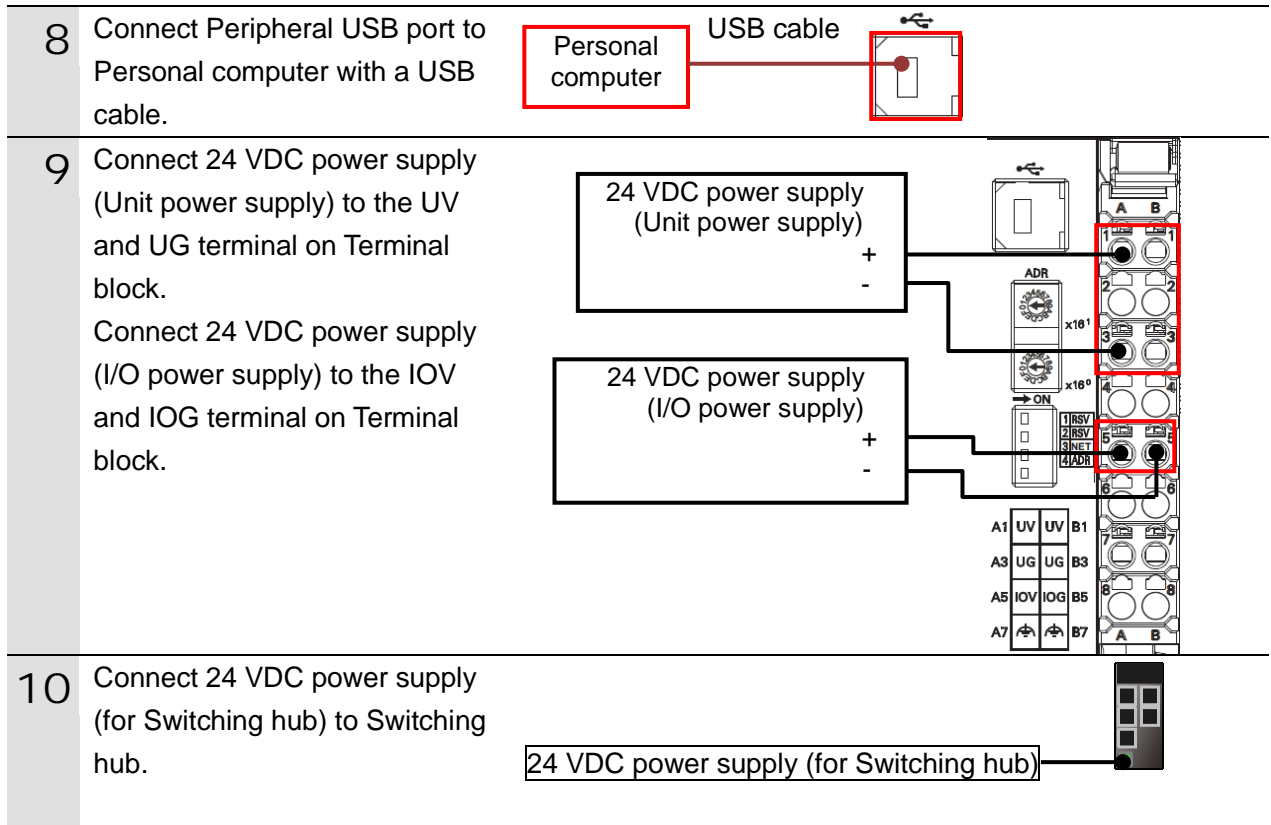

7.2.2. Parameter Settings

Set the parameters for Slave Terminal.

The parameters are set using Sysmac Studio.

Install Sysmac Studio and the USB driver on Personal computer beforehand.



Additional Information

For information on how to install Sysmac Studio and the USB driver, refer to *A-1 Driver Installation for Direct USB Cable Connection* in *Appendices of the Sysmac Studio Version 1 Operation Manual* (Cat. No. W504).

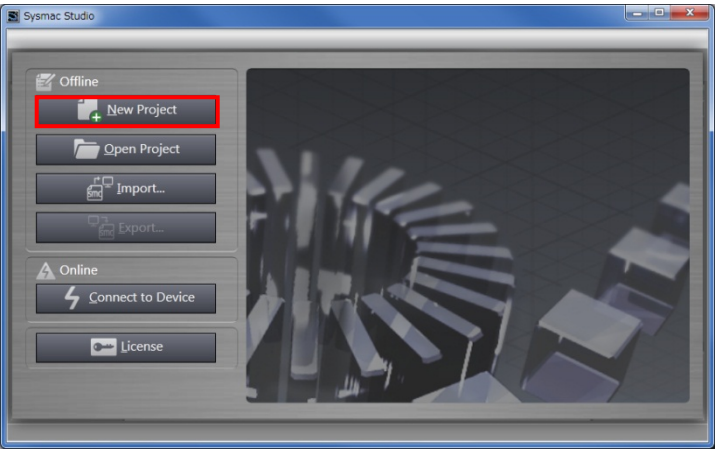
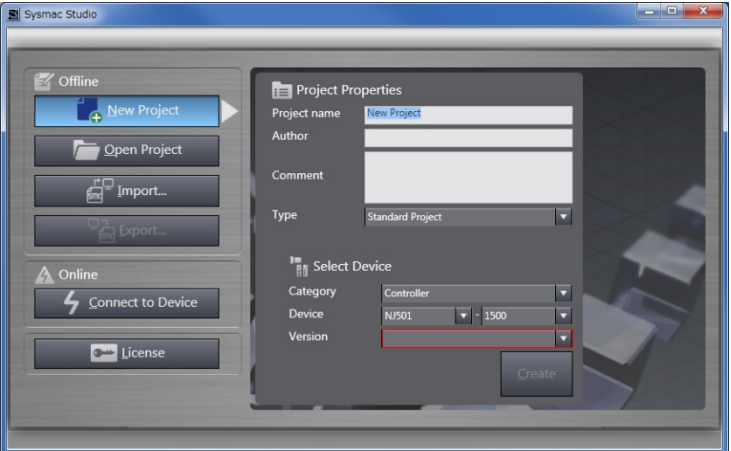
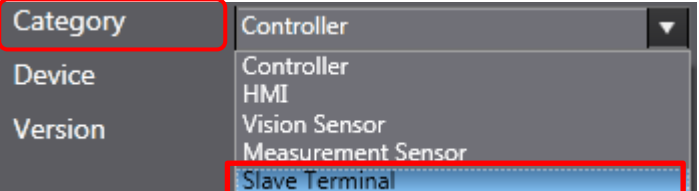
<p>1</p>	<p>Turn ON Unit power supply for Slave Terminal.</p>	
<p>2</p>	<p>Start Sysmac Studio.</p> <p>*If the User Account Control Dialog Box is displayed at start, make a selection to start Sysmac Studio.</p>	
<p>3</p>	<p>Sysmac Studio starts. Click New Project.</p>	
<p>4</p>	<p>The Project Properties Dialog Box is displayed.</p> <p>*In this document, New Project is used as the project name.</p> <p>Select Slave Terminal from the pull-down list of Category.</p>	 

- 5 Check that EtherNet/IP Coupler is selected in the *Device* Field. Click **Create**.

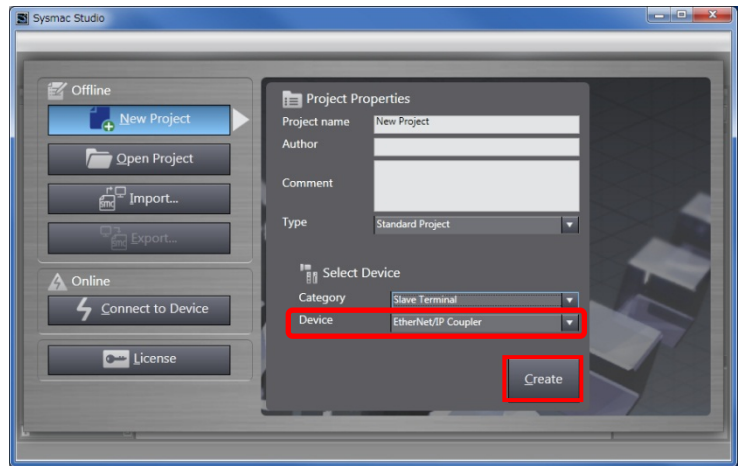

- 6 The New Project is displayed.

The following panes are displayed in this window.

Left: Multiview Explorer

Top right: Toolbox

Middle top: Edit Configuration Pane

The following tabs are displayed in the bottom middle of this window.

Output Tab Page

Build Tab Page

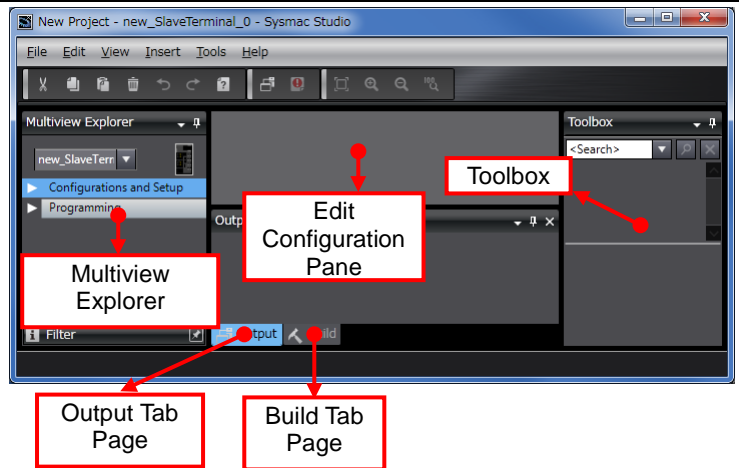

- 7 Double-click **NX-EIC202** under **Configurations and Setup - EtherNet/IP** in the Multiview Explorer.

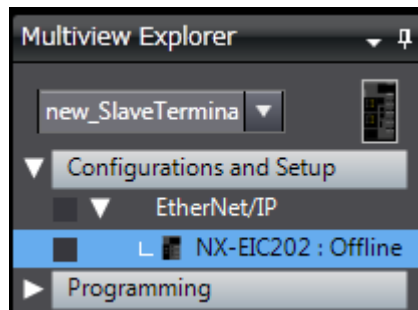

- 8 The EIP Tab Page is displayed in the Edit Configuration Pane. Click **Online**.

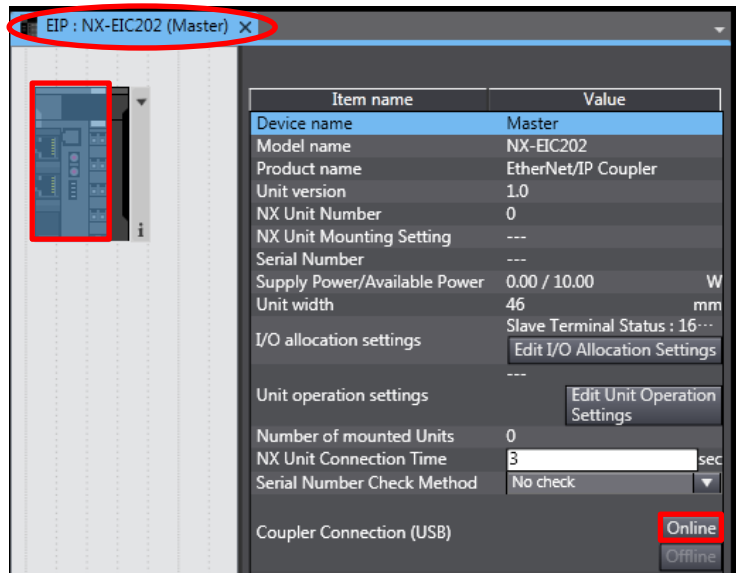

- 9 A confirmation dialog box is displayed. Check the contents and click **OK**.

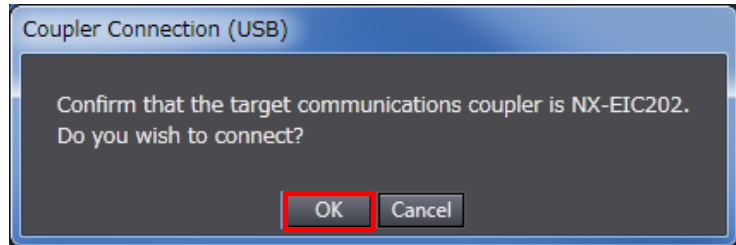

- 10 When an online connection is established, a yellow bar is displayed under the toolbar.

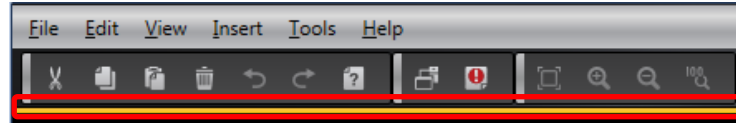

- 11 Right-click the device icon of Coupler Unit and select **Compare and Merge with Actual Unit Configuration**.

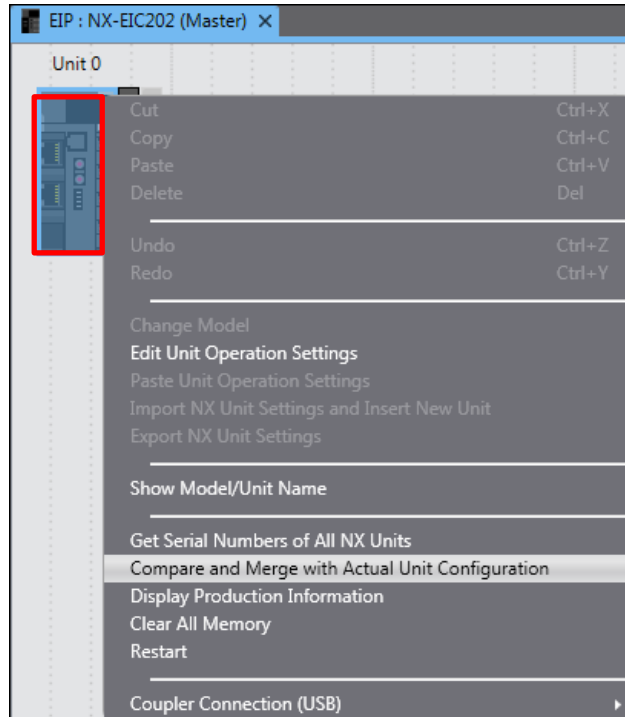

- 12 The Compare and Merge with Actual Unit Configuration Dialog Box is displayed. Check that the Units are displayed in Actual Unit Configuration as shown in 6.2. *Slave Terminal Configuration* and that Added is shown in the *Result* Column.

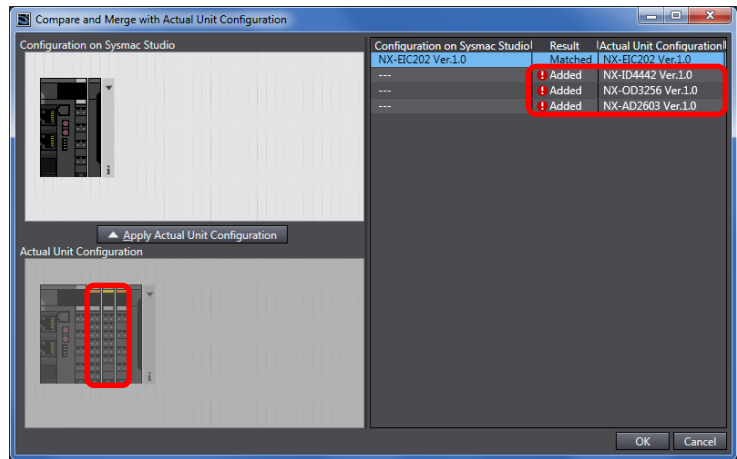

- 13 Click **Apply Actual Unit Configuration**.

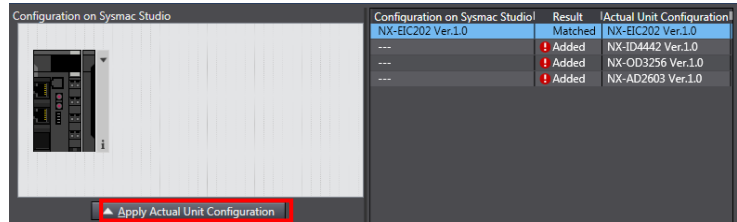

- Check that the each of the units is displayed in Configuration on Sysmac Studio and that Matched is displayed in the *Result* Column.

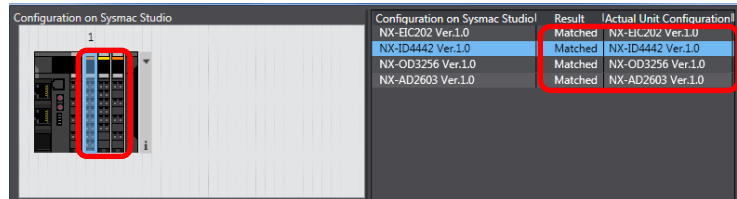

- 14 Click **OK**.



- 15 The Units are added to Coupler Unit in the EIP Tab Page as shown in 6.2. *Slave Terminal Configuration*.

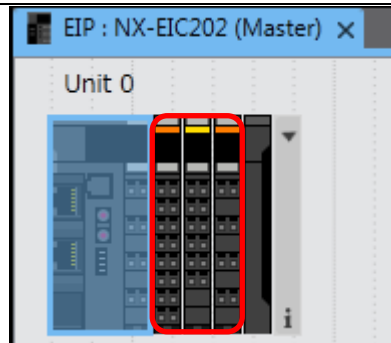

16 Right-click the device icon of Coupler Unit and select **Coupler Connection (USB) - Transfer to Coupler** from the menu.

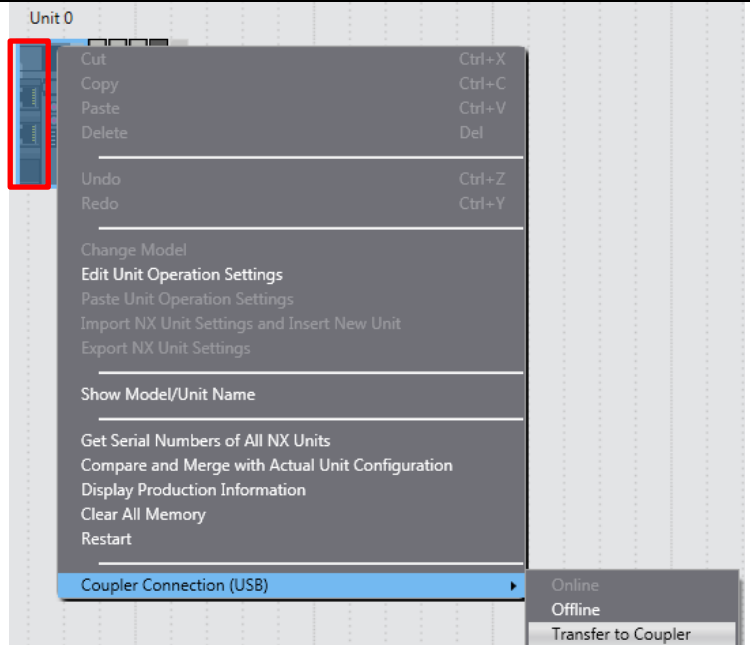

17 The Transfer to Coupler Dialog Box is displayed. Click **Configuration information + Unit operation settings + Unit application data**.

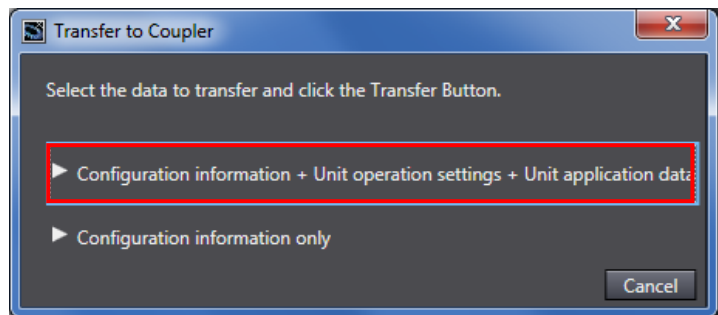

18 A confirmation dialog box is displayed. Check the contents and click **Yes**.

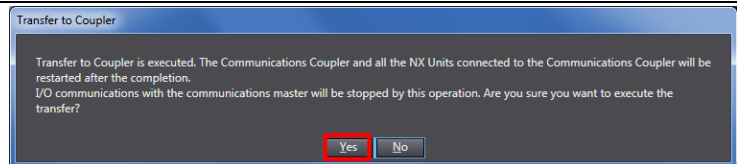

A screen is displayed stating "Transfer to Coupler".

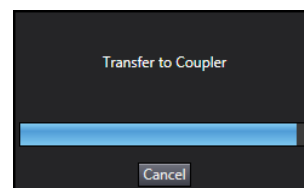

19 Right-click the device icon of Coupler Unit and select **Coupler Connection (USB) - Compare.**

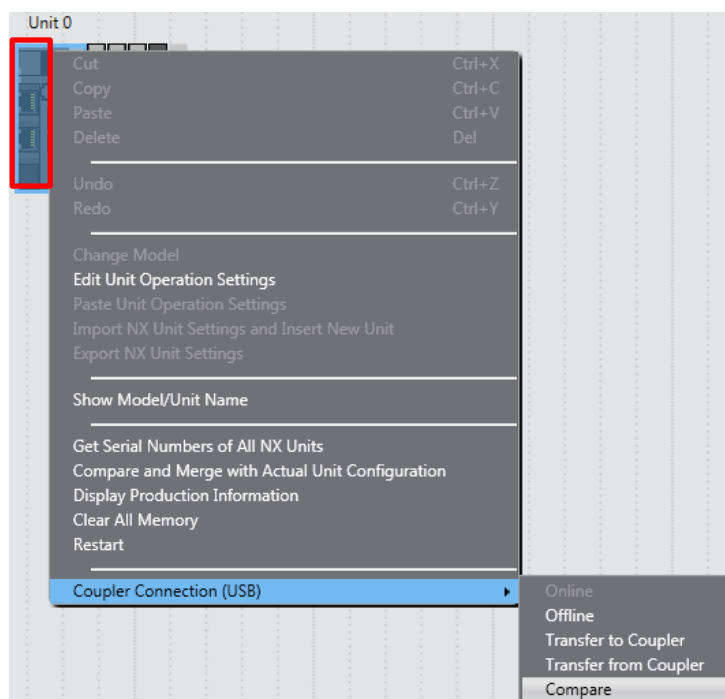

A dialog box is displayed stating "Compare is being executed".

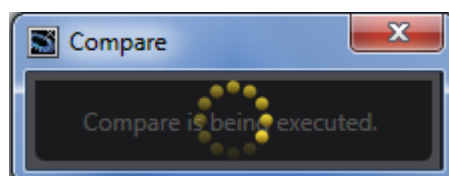

20 A confirmation dialog box is displayed. Check the contents and click **OK.**

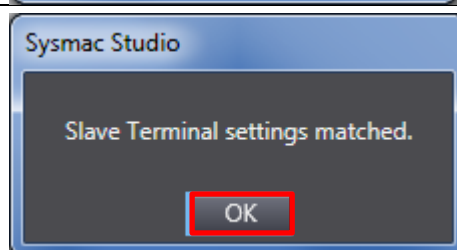

7.3. PLC Setup

Set up PLC.

7.3.1. Hardware Settings

Set the hardware switches on EtherNet/IP Unit and wire the network.



Precautions for Correct Use

Make sure that the power supply is OFF when you set up.

<p>1</p>	<p>Make sure that PLC and Switching hub are powered OFF.</p> <p>*If either of them is ON, the settings described in the following steps and subsequent procedures may not be applicable.</p>	
<p>2</p>	<p>Check the position of hardware switches on the front panel of EtherNet/IP Unit by referring to the figure on the right.</p>	
<p>3</p>	<p>Set Unit number setting switch to 0.</p>	<p>The unit number is used to identify individual CPU Bus Units when more than one CPU Bus Unit is mounted to the same PLC. Use a small screwdriver to make the setting, taking care not to damage the rotary switch. The unit number is factory-set to 0.</p>
<p>4</p>	<p>Set Node address setting switches to the following default settings.</p> <p>NODE No.x16¹: 0 NODE No.x16⁰: 1</p> <p>*The IP address is set to 192.168.250.1.</p> <p>*By default, the first to third octets of the local IP address are fixed to 192.168.250. The fourth octet is a value that is set with Node address setting switches.</p>	<p>With the FINS communications service, when there are multiple EtherNet/IP Units connected to the Ethernet network, the EtherNet/IP Units are identified by node addresses. Use the node address switches to set the node address between 01 and FE hexadecimal (1 to 254 decimal). Do not set a number that has already been set for another node on the same network.</p> <p>The left switch sets the sixteens digit (most significant digit) and the right switch sets the ones digit (least significant digit). The node address is factory-set to 01.</p> <p>Default IP address = 192.168.250.node address</p> <p>With the factory-default node address setting of 01, the default IP address is 192.168.250.1.</p>

5 Connect a LAN cable to the EtherNet/IP port on PLC, and connect a USB cable to the USB port. As shown in 5.2. *Device Configuration*, connect Personal computer and Switching Hub to PLC.

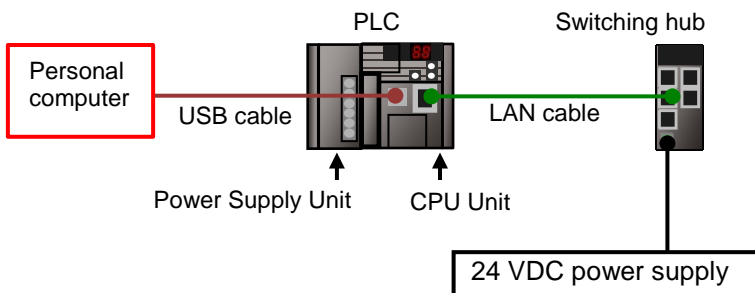

6 Turn ON PLC and Switching hub.



7 The set IP address is displayed on the seven-segment LED indicators. Afterwards, the last digit of the IP address is displayed in hexadecimal during normal operation.

7.3.2. Starting CX-Programmer and Connecting Online with PLC

Start CX-Programmer and connect online with PLC.

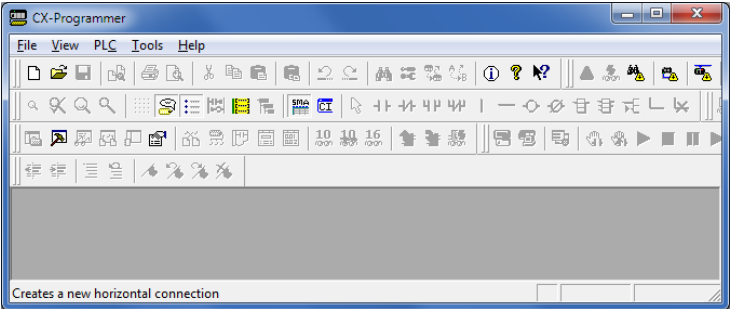
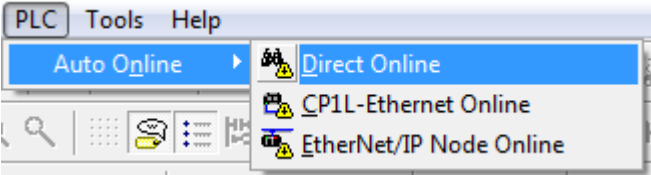
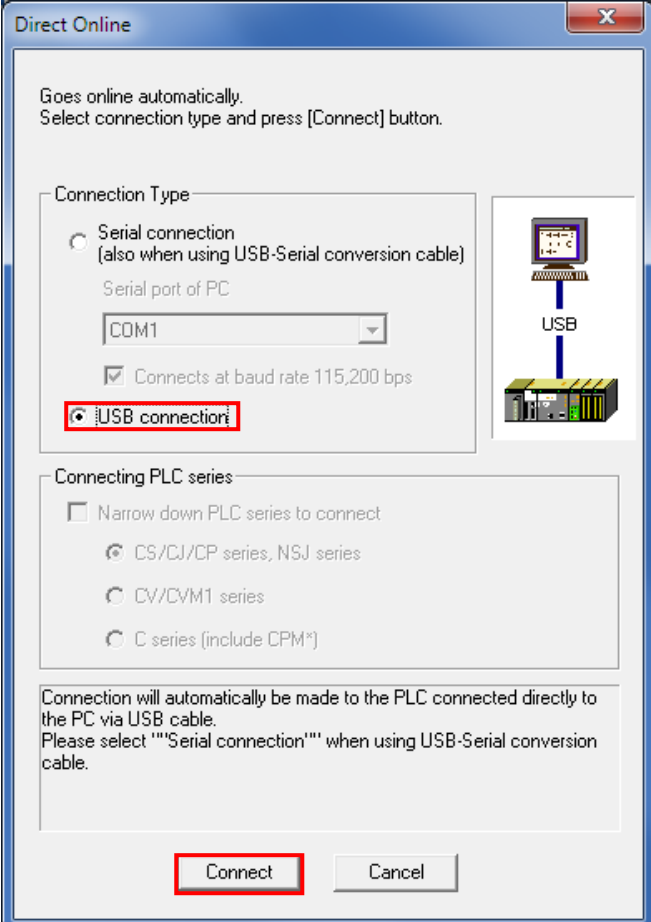
Install CX-One and the USB driver on Personal computer beforehand.

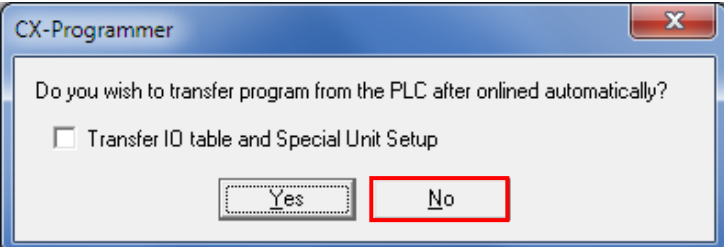
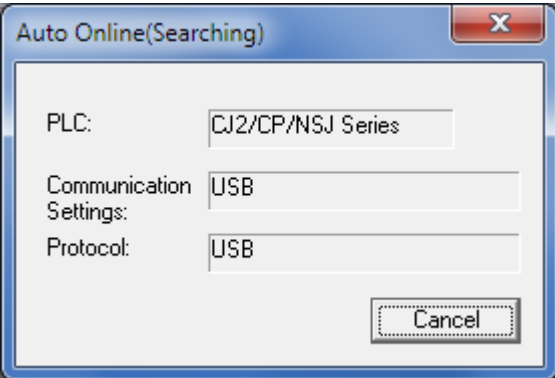
1	<p>Start CX-Programmer.</p> <p>*If the User Account Control Dialog Box is displayed at start, make a selection to start CX-Programmer.</p>	
2	<p>CX-Programmer starts.</p>	
3	<p>Select Auto Online - Direct Online from the PLC Menu.</p>	
4	<p>The Direct Online Dialog Box is displayed.</p> <p>Select USB connection as Connection Type.</p> <p>Click Connect.</p>	

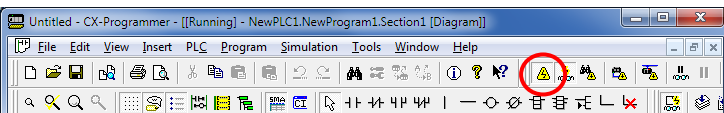
5	The dialog box on the right is displayed. Check the contents and click No .	
6	The dialog box on the right is displayed. CX-Programmer and PLC are automatically connected.	
7	<p>Check that CX-Programmer and PLC are normally connected online.</p> <p>*The  icon is pressed down during online connection.</p>	



Additional Information

If PLC cannot be connected online, check the cable connection.

Or, return to step 1, check the settings and repeat each step.

For details, refer to *Connecting Directly to a CJ2 CPU Unit Using a USB Cable* of the *CX-Programmer OPERATION MANUAL* (Cat. No. W446).



Additional Information

The dialog boxes explained in the subsequent procedure may not be displayed depending on the environmental settings of CX-Programmer.

For details on the environmental settings, refer to *Options and Preferences* in *CHAPTER 3 Project Reference* in *PART 1: CX-Programmer* of the *CX-Programmer OPERATION MANUAL* (Cat. No. W446).

This document explains the setting procedures when "Confirm all operations affecting the PLC" is selected.

7.3.3. Creating the I/O Table and Setting the IP Address

Create the I/O table and set the IP address of PLC.

1 If the operating mode of PLC is Run Mode or Monitor Mode, change it to Program Mode by following the steps below.

(1) Select **Operating Mode - Program** from the PLC Menu in CX-Programmer.

(2) The dialog box on the right is displayed. Confirm that there is no problem, and click **Yes**.
*Refer to *Additional Information* on the previous page for the settings concerning the dialog display.

(3) Check that Stop/Program Mode is displayed on the right of the PLC model in the Project Workspace of CX-Programmer.

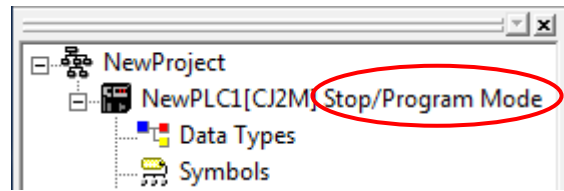
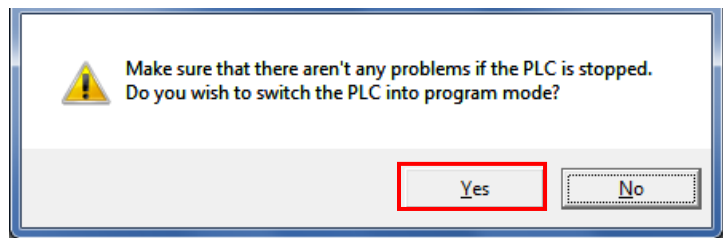
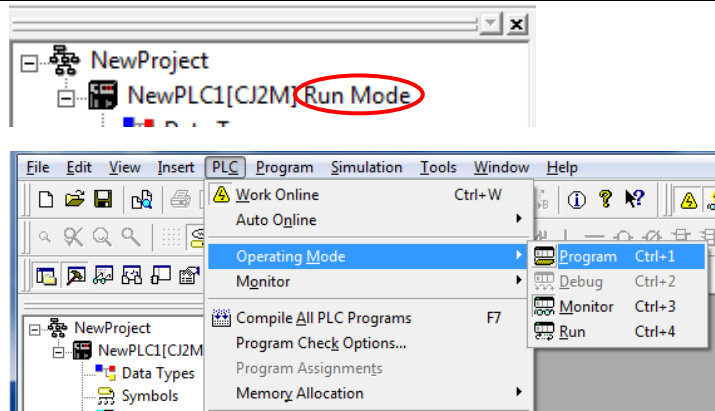

(Project Workspace)

2 Select **Edit - I/O Table and Unit Setup** from the PLC Menu in CX-Programmer.

The PLC IO Table Window is displayed.

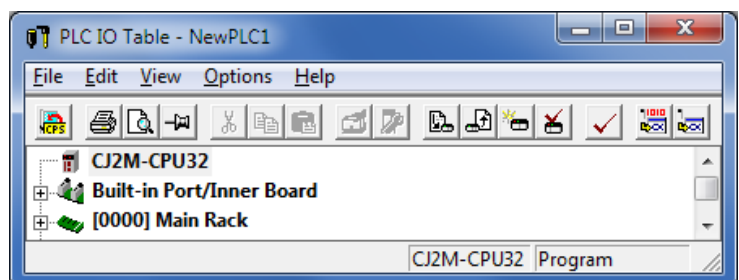
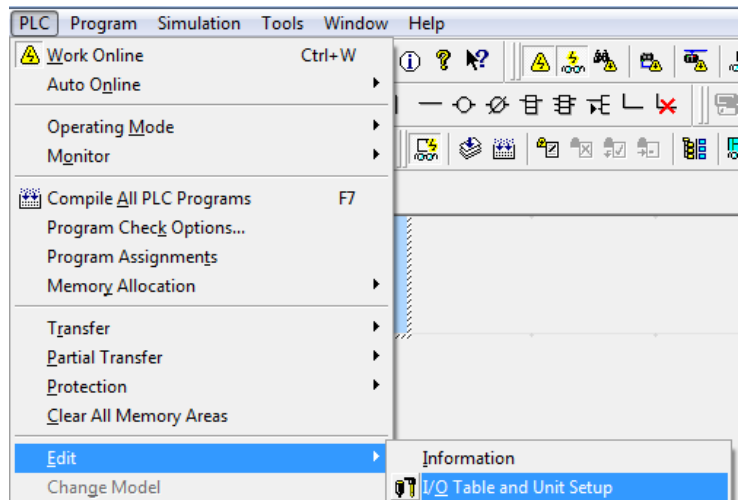

Precautions for Correct Use

The PLC is reset after creating and transferring the I/O table in step 3 and subsequent steps. Always confirm safety before creating and transferring the I/O table.

- 3 Select **Create** from the Options Menu in the PLC IO Table Window.

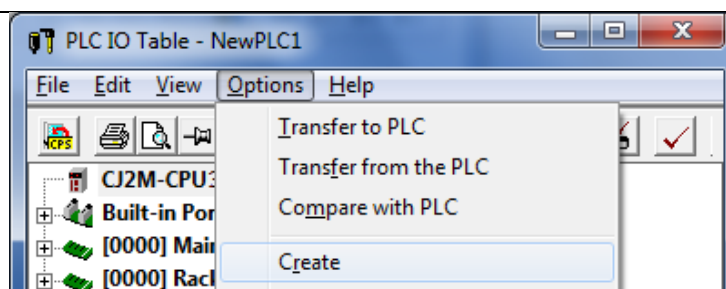

The dialog box on the right is displayed. Confirm that there is no problem, and click **Yes**.

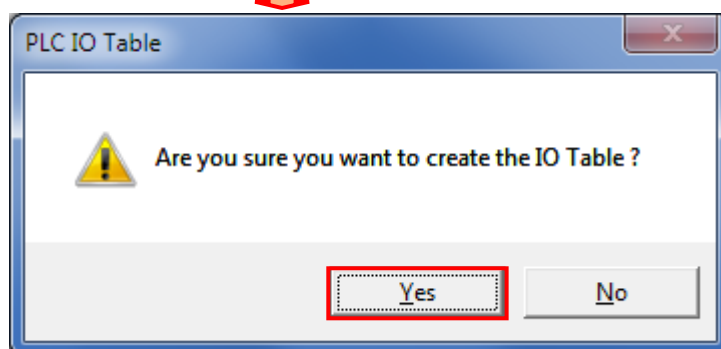

The dialog box on the right is displayed. Confirm that there is no problem, and click **Yes**.

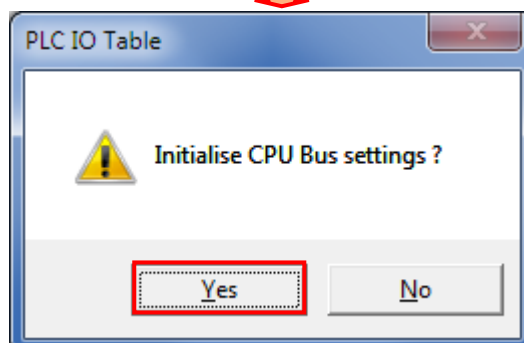

- 4 The Transfer from PLC Dialog Box is displayed.
 Select *IO Table* and *SIO Unit Parameters*.
 Click **Transfer**.

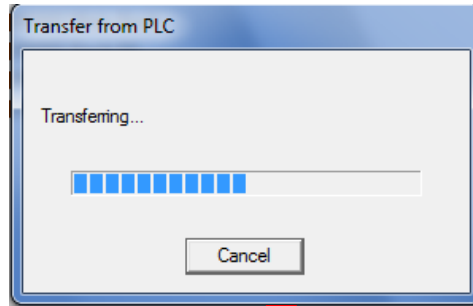
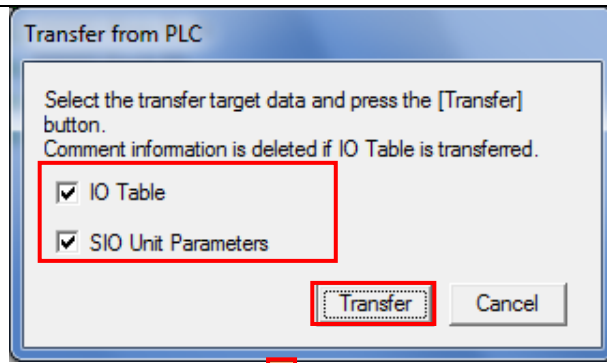

When the transfer is completed, the Transfer Results Dialog Box is displayed.

Check that the transfer is successfully completed by referring to the message in the dialog box.

When the I/O table is created normally, the dialog box displays as follows:

Transfer Success: 1 Unit
 Transfer Unsuccessful: 0 Unit

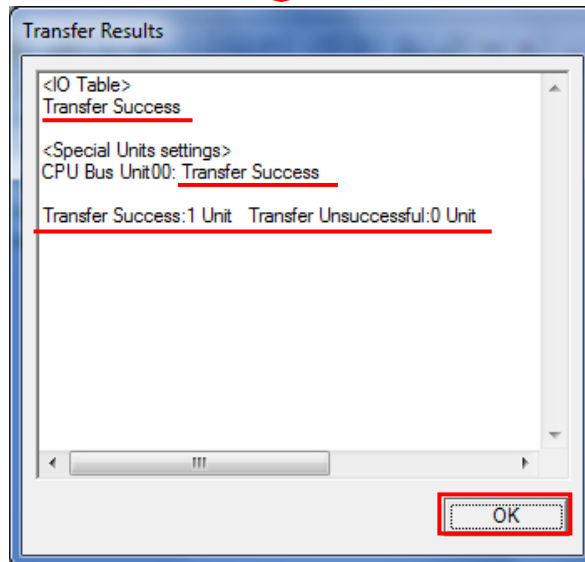

Click **OK**.

- 5 In the PLC IO Table Window, click + to the left of Built-in Port/Inner Board to display CJ2M-EIP21.

*The figure on the right displays CPU Unit (Built-in EtherNet/IP port) specified in 5.2. *Device Configuration*. If you use an other applicable EtherNet/IP Unit, the display position and name are different from the figure on the right.

Right-click **CJ2M-EIP21** and select **Unit Setup**.

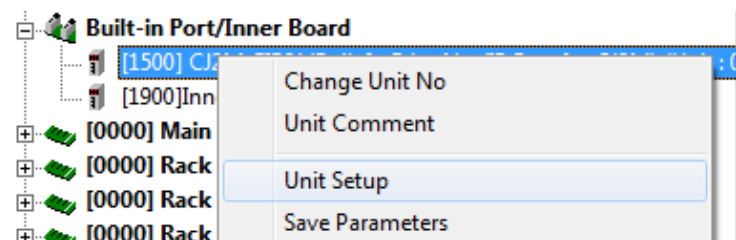
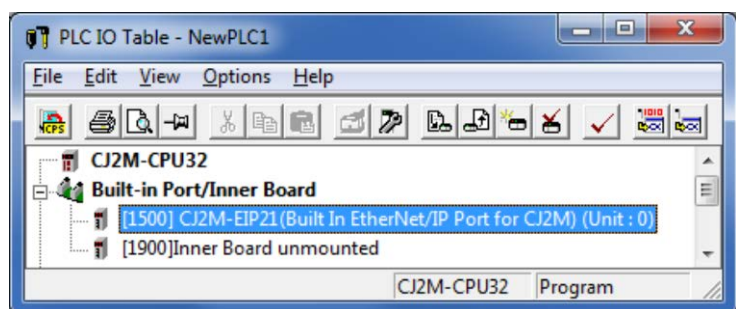

6 The Edit Parameters Dialog Box is displayed.

Select the **TCP/IP** Tab.

Make the following settings in the *IP Address* Field.

- Use the following address:
Select
- IP address: 192.168.250.1
- Subnet mask: 255.255.255.0

Click **Transfer[PC to Unit]**.

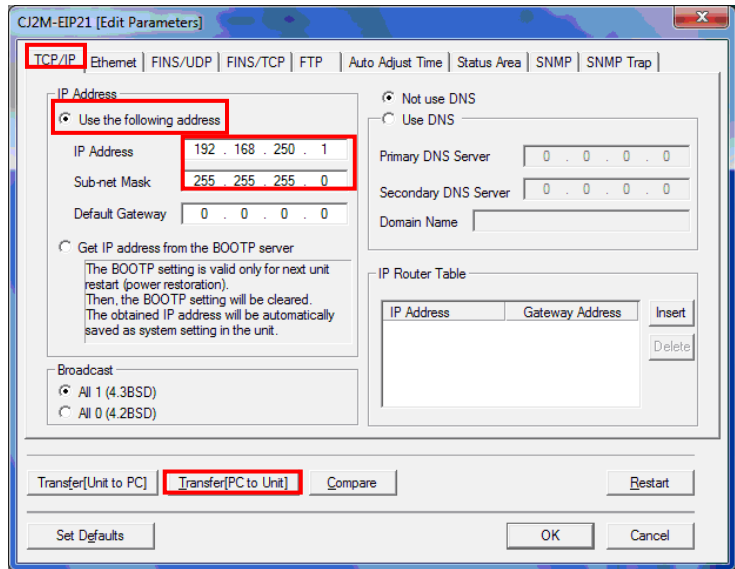

7 The dialog box on the right is displayed. Confirm that there is no problem, and click **Yes**.

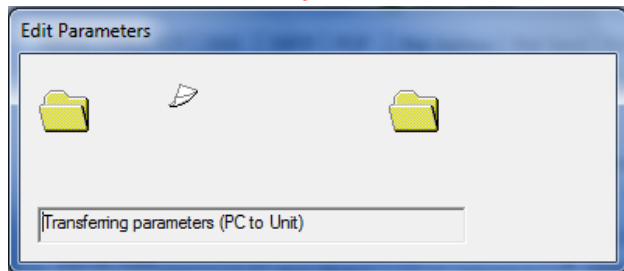
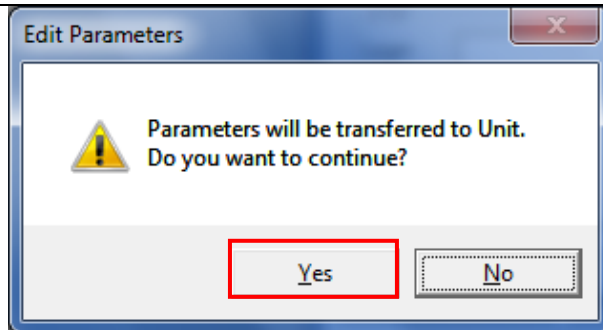

Check that a message is displayed stating "Transfer successful".
Click **Close**.

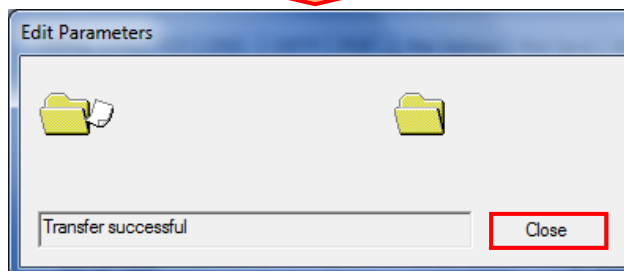

- 8 The dialog box on the right is displayed. Check the contents and click **Yes**.

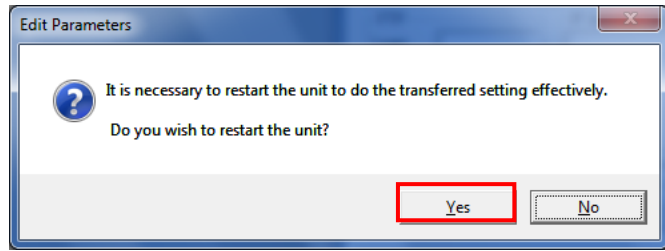

When the Unit is restarted, the dialog box on the right is displayed. Check the contents and click **OK**.

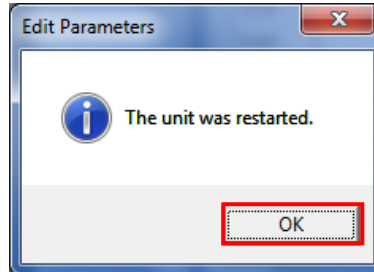

- 9 Click **Compare** to check that the IP address is correctly changed.

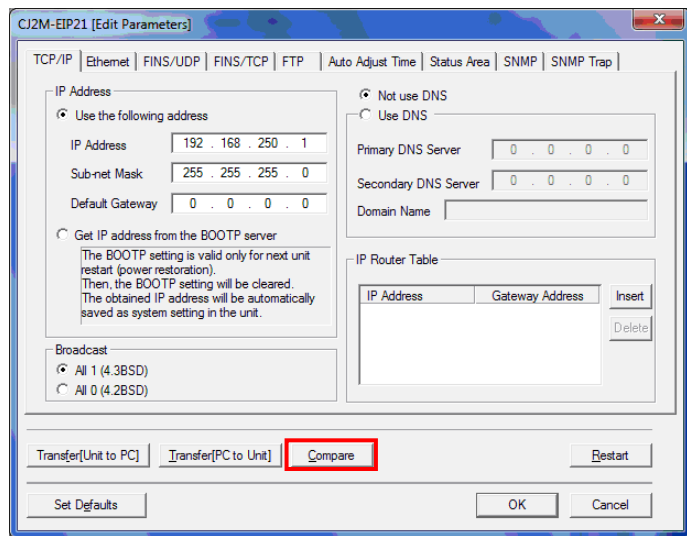

- 10 Check that a message is displayed stating "Compare successful". Click **Close**.

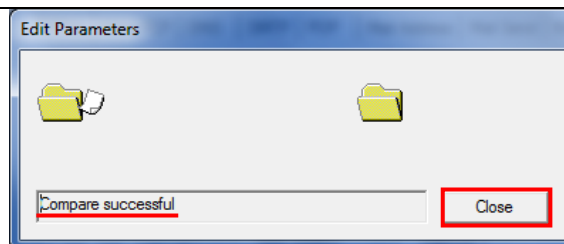

- 11 Click **OK** in the Edit Parameters Dialog Box.

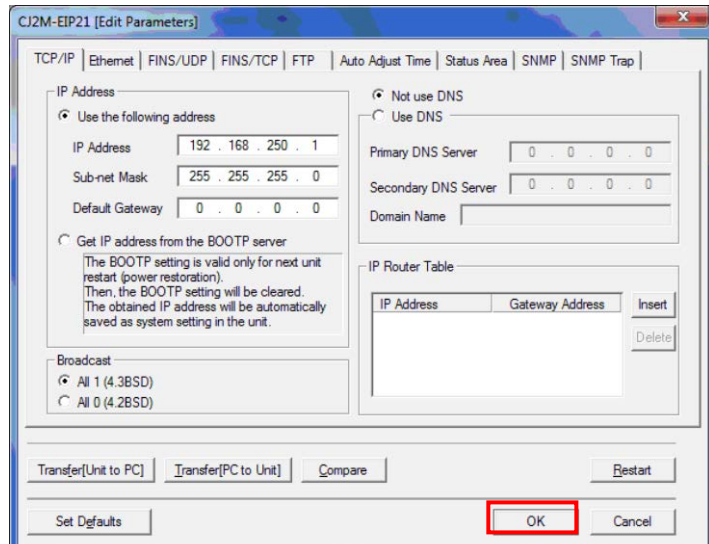

7.4. Network Settings

Set the EtherNet/IP tag data links.

7.4.1. Starting Network Configurator and Connecting Online with PLC

Start Network Configurator and connect online with PLC.

- 1 Right-click **CJ2M-EIP21** in the PLC IO Table Window, and select **Start Special Application - Start with Settings Inherited.**

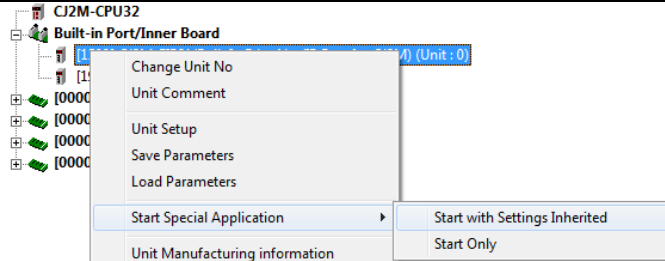

The Select Special Application Dialog Box is displayed. Select *Network Configurator* and click **OK**.

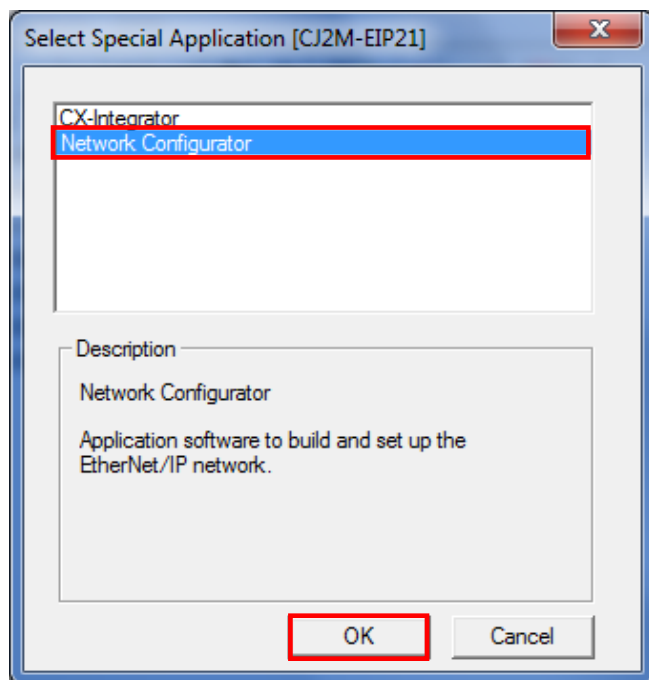

- 2 Network Configurator starts. The following panes are displayed in this window. Left: Hardware List
Right: Network Configuration Pane

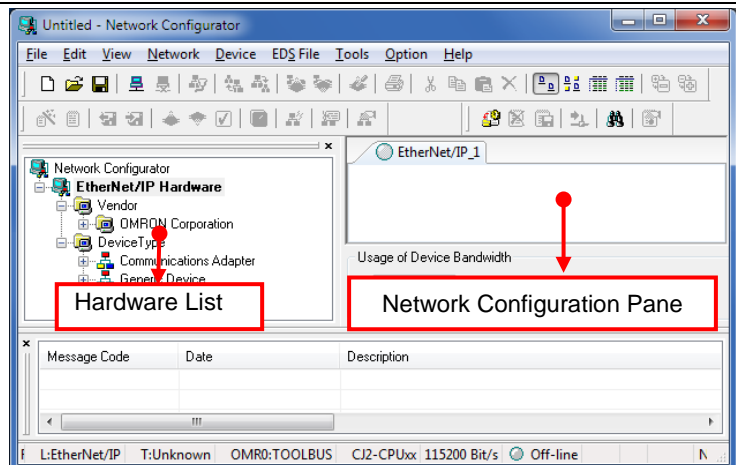



Precautions for Correct Use

Check that the LAN cables are connected before performing the following steps.
If they are not connected, turn OFF the each device, and then connect the LAN cables.

<p>3 Select Select Interface - CJ2 USB/Serial Port from the Option Menu.</p>	
<p>4 Select Connect from the Network Menu.</p>	
<p>5 The Setup Interface Dialog Box is displayed. Check that the following settings are made. Port Type: USB Port: OMR0 Baud Rate: 115200 Bit/s Click OK.</p>	
<p>6 The Select Connect Network Port Dialog Box is displayed. Select BackPlane - CJ2M-EIP21 - TCP:2. Click OK.</p>	

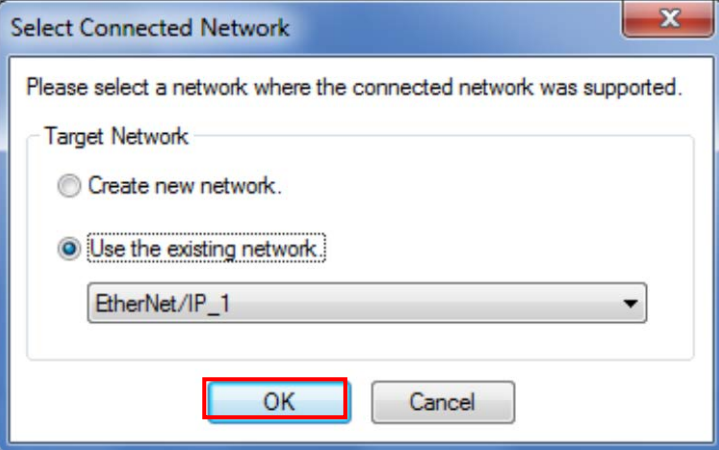
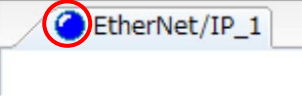
<p>7 The Select Connected Network Dialog Box is displayed. Check the contents and click OK.</p>	
<p>8 When an online connection is established normally, the color of the icon changes to blue as shown on the right.</p>	



Additional Information

If PLC cannot be connected online, check the cable connection.

Or, return to step 3, check the settings and repeat each step.

For details, refer to 6-2-9 *Connecting the Network Configurator to the Network* in SECTION 6 *Tag Data Link Functions of the EtherNet/IP™ Units OPERATION MANUAL* (Cat. No. W465).

7.4.2. Uploading the Network Configuration

Upload the network configuration.

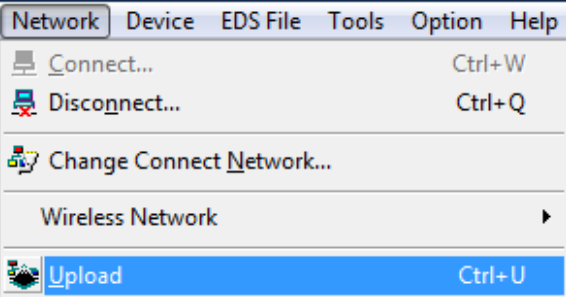
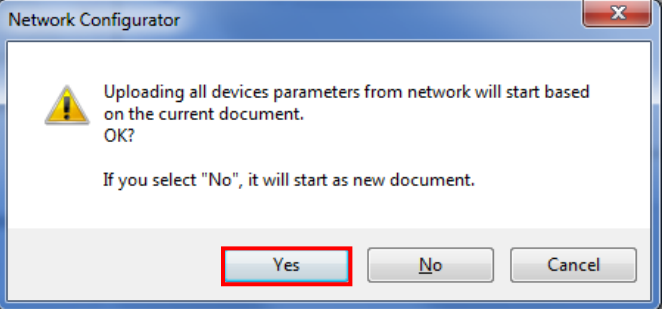
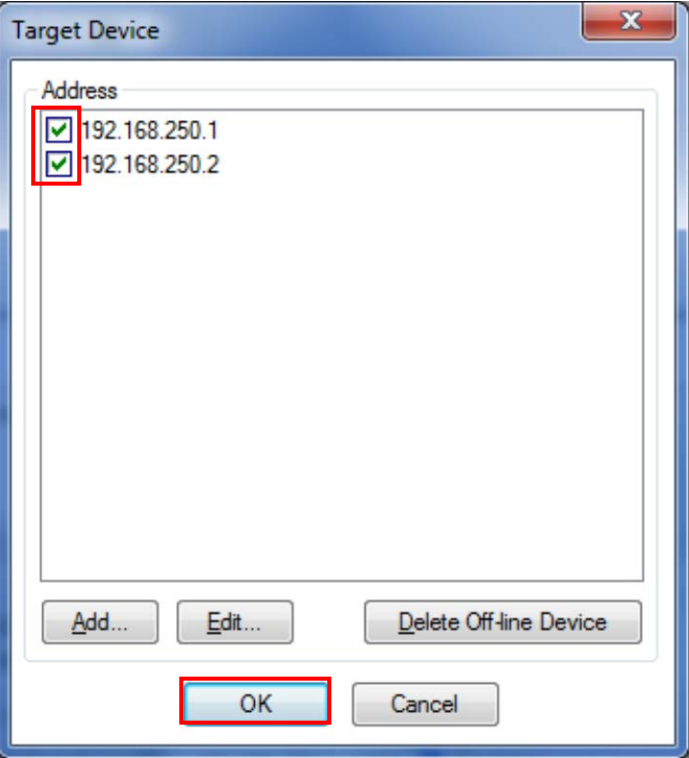
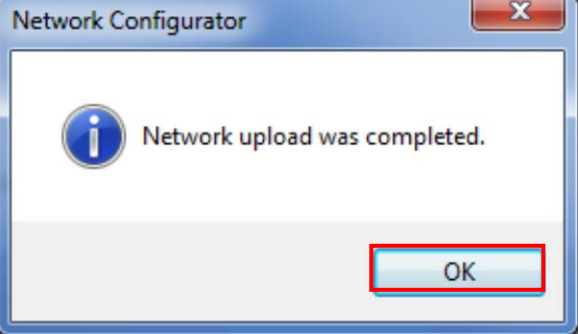
<p>1 Select Upload from the Network Menu to upload the device information on the network.</p>	
<p>2 The dialog box on the right is displayed. Confirm that there is no problem, and click Yes.</p>	
<p>3 The Target Device Dialog Box is displayed. Select 192.168.250.1 and 192.168.250.2.</p> <p>Click OK.</p> <p>*If 192.168.250.1 and 192.168.250.2 are not displayed in the dialog box, click Add to add the addresses.</p> <p>*A displayed address depends on the status of Network Configurator.</p>	
<p>4 The device parameters are uploaded. When the uploading is completed, the dialog box on the right is displayed. Check the contents and click OK.</p>	

- 5 After uploading, check that the IP addresses of uploaded nodes are updated in the Network Configuration Pane as follows:

IP address of node 1:

192.168.250.1

IP address of node 2:

192.168.250.2

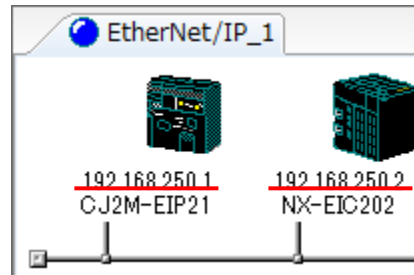

7.4.3. Setting the Tags

Register tags for input (consume) and output (produce).

The following explains the receive and send settings of the target device in order.

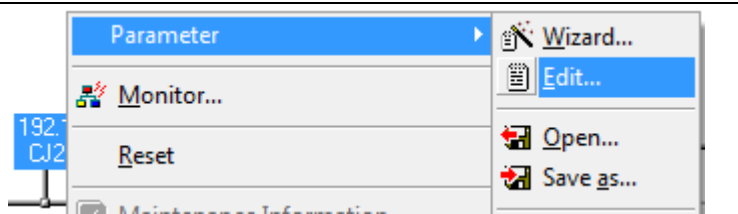
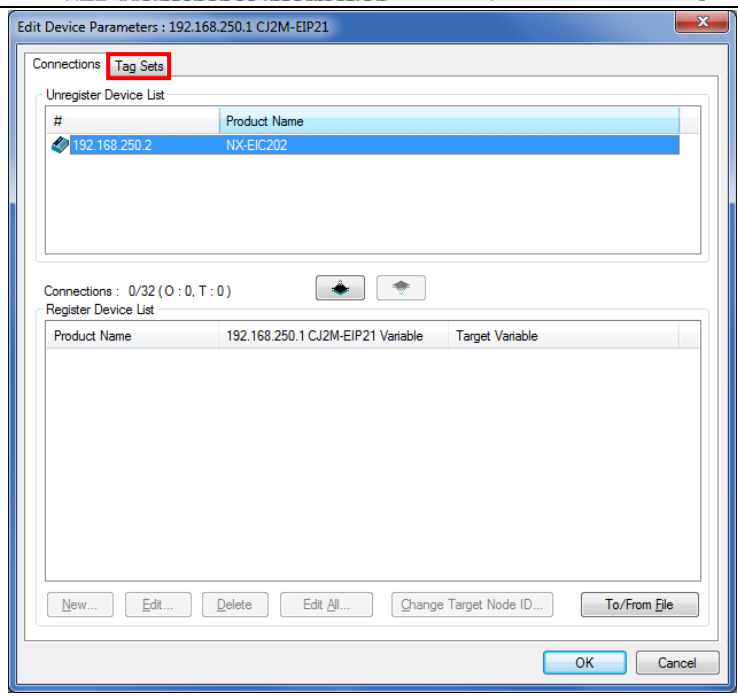
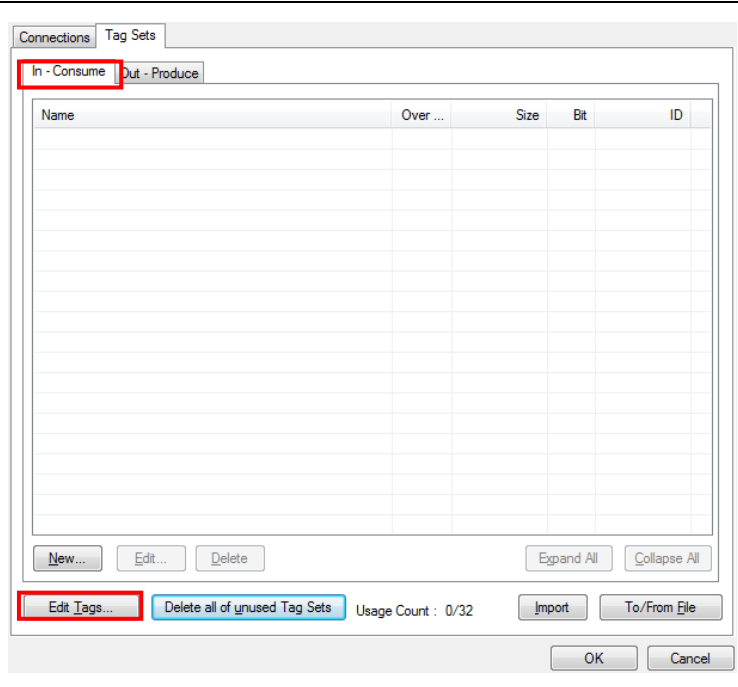
<p>1 In the Network Configuration Pane of Network Configurator, right-click the node 1 device and select Parameter - Edit.</p>	 <p>A screenshot of a context menu in the Network Configurator. The menu items are: Parameter (highlighted), Monitor..., Reset, Wizard..., Edit..., Open..., and Save as... The 'Parameter' item is highlighted with a blue background.</p>
<p>2 The Edit Device Parameters Dialog Box is displayed. Select the Tag Sets Tab.</p>	 <p>A screenshot of the 'Edit Device Parameters' dialog box for device 192.168.250.1 CJ2M-EIP21. The 'Tag Sets' tab is selected and highlighted with a red box. The dialog shows an 'Unregister Device List' table with one entry: 192.168.250.2 NX-EIC202. Below this is a 'Register Device List' table with columns for Product Name, Variable, and Target Variable. At the bottom, there are buttons for 'New...', 'Edit...', 'Delete', 'Edit All...', 'Change Target Node ID...', 'To/From File', 'OK', and 'Cancel'.</p>
<p>3 The data on the Tag Sets Tab Page is displayed. Select the In-Consume Tab and click Edit Tags.</p>	 <p>A screenshot of the 'Tag Sets' tab page in the dialog box. The 'In - Consume' tab is selected and highlighted with a red box. Below the tab is a table with columns: Name, Over ..., Size, Bit, and ID. The table is currently empty. At the bottom, there are buttons for 'New...', 'Edit...', 'Delete', 'Expand All', 'Collapse All', 'Edit Tags...' (highlighted with a red box), 'Delete all of unused Tag Sets', 'Usage Count : 0/32', 'Import', 'To/From File', 'OK', and 'Cancel'.</p>

- 4 The Edit Tags Dialog Box is displayed. Select the **In - Consume** Tab and click **New**. Here, register a tag for the area where the node 1 consumes data from the node 2.

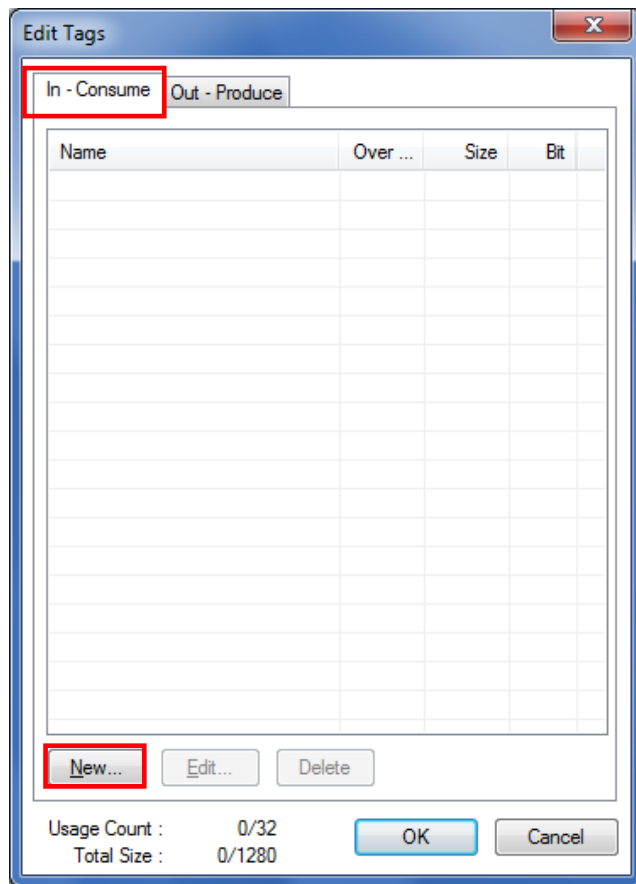

- 5 The Edit Tag Dialog Box is displayed. Enter the following values of the parameters.

Name: *D10100* (Start address of the input data to node 1)
 Size: 8 (Byte)

After entering, click **Regist**.

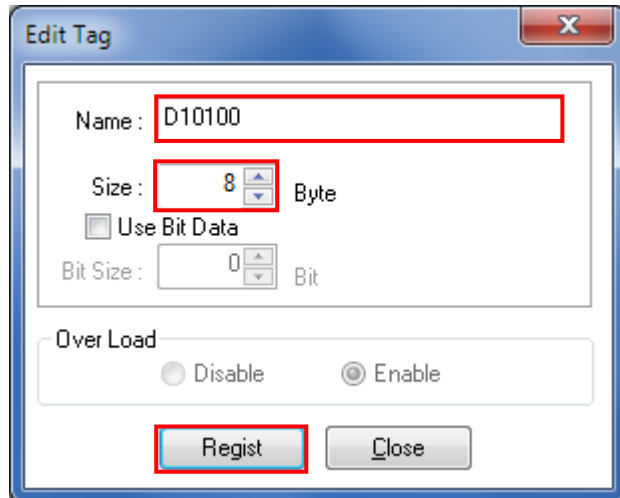

- 6 The Edit Tag Dialog Box is displayed again. Click **Close**.



- 7 Select the **Out - Produce** Tab and click **New**.
Here, register a tag for the area where the node 1 produces data to the node 2.

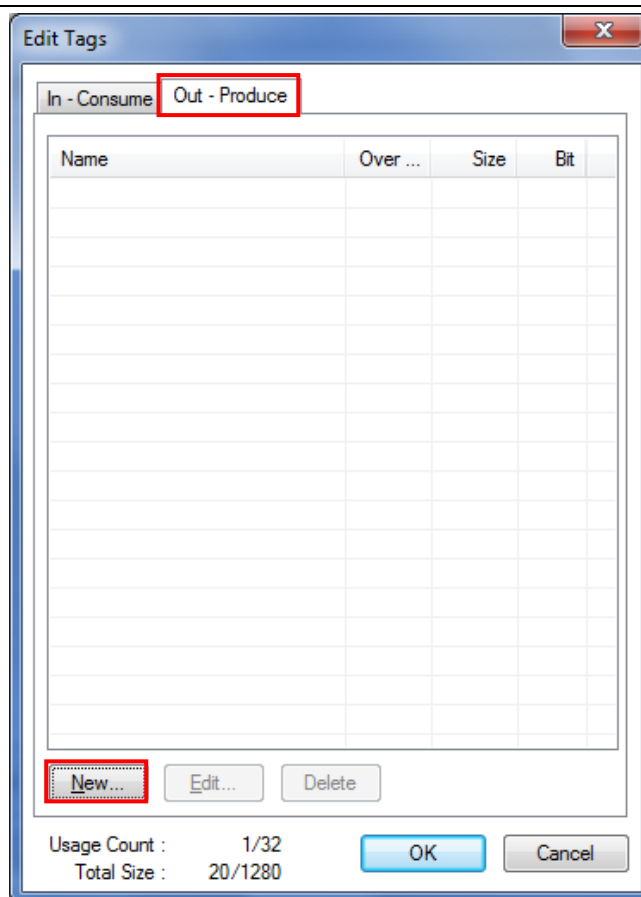

- 8 The Edit Tag Dialog Box is displayed. Enter the following values of the parameters.

Name: *D10000* (Start address of the output data from node 1)
Size: 2 (Byte)

After entering, click **Regist**.

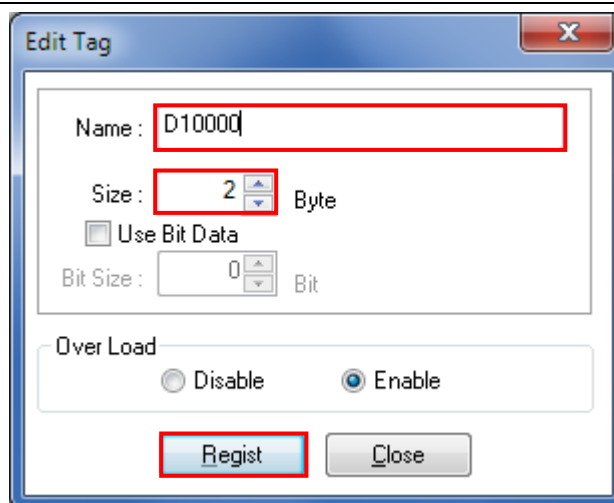

- 9 The Edit Tag Dialog Box is displayed again. Click **Close**.



10 When you finish the registration, click **OK** in the Edit Tags Dialog Box.

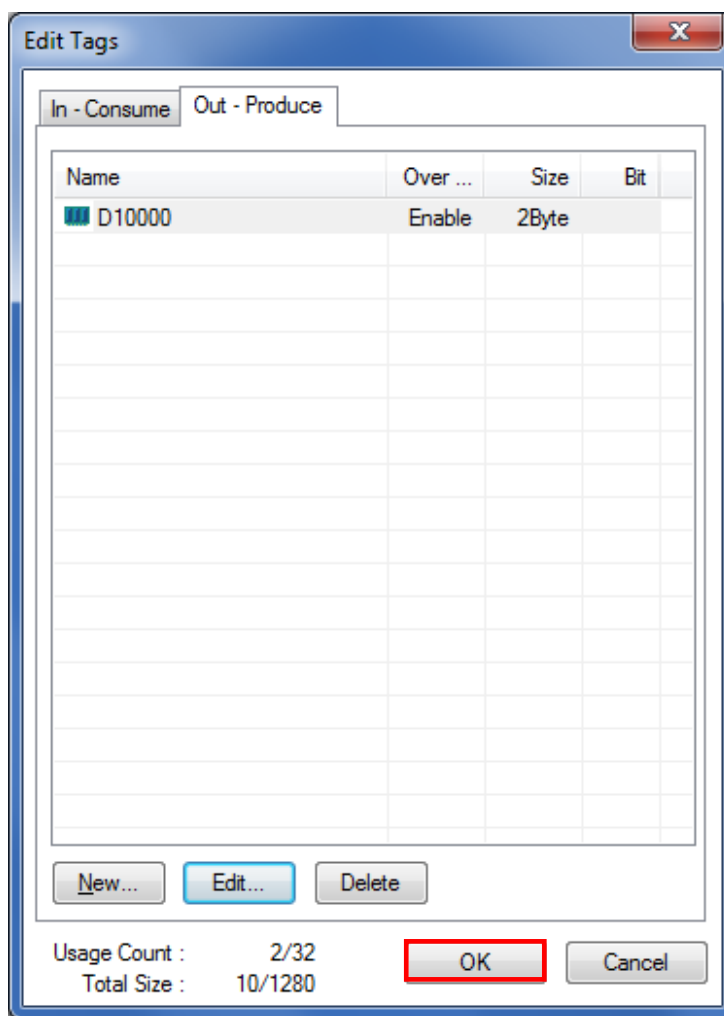

11 The dialog box on the right is displayed. Confirm that there is no problem, and click **Yes**.

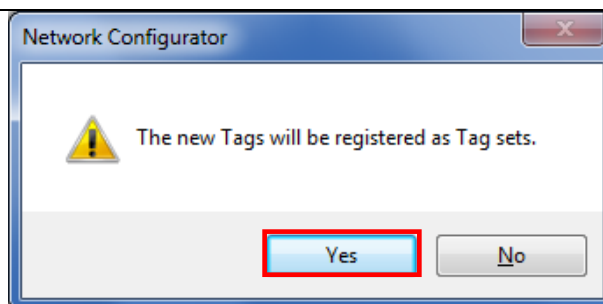

12 The Edit Device Parameters Dialog Box is displayed again. Select the **Connections** Tab.

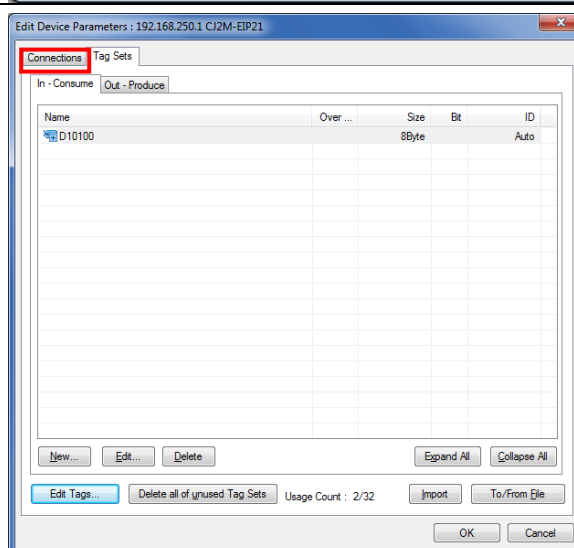

7.4.4. Setting the Connections

Associate the tags of the target device (that receives the open request) with the tags of the originator device (that requests for opening).

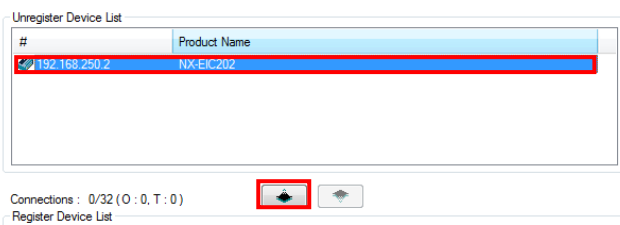
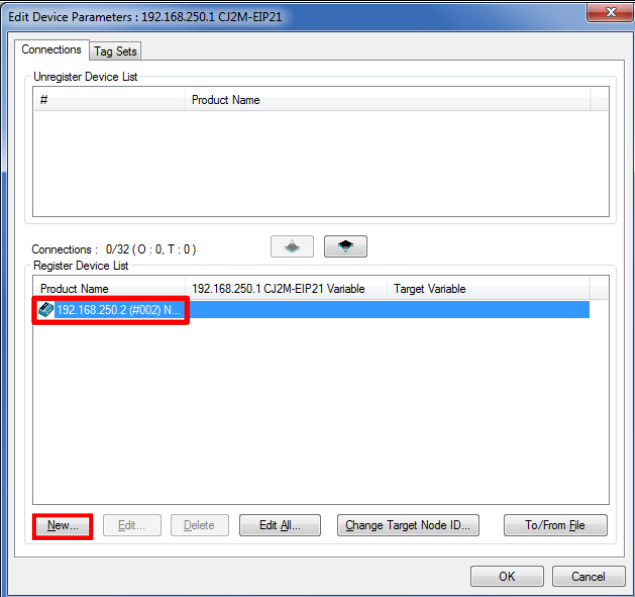
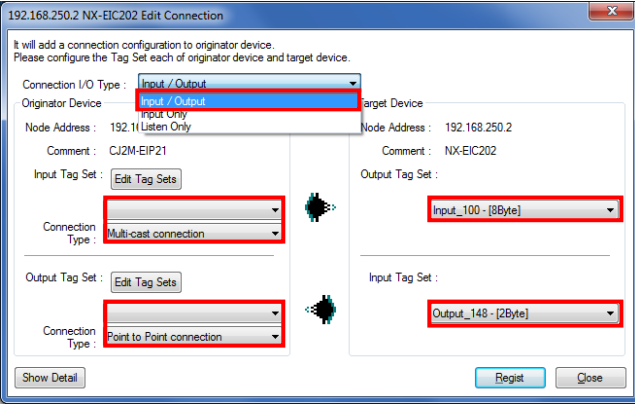
<p>1 Select <i>192.168.250.2</i> in the <i>Unregister Device List</i> Field. Click the Down Arrow Button that is shown in the dialog box.</p>	
<p>2 <i>192.168.250.2</i> is registered in the <i>Register Device List</i> Field. Select <i>192.168.250.2</i> and click New.</p>	
<p>3 The Edit Connection Dialog Box is displayed. Select Input / Output from the pull-down list of Connection I/O Type. Set the values listed in the following table in the <i>Originator Device</i> and the <i>Target Device</i> Fields.</p>	

■ Connection configuration settings

Connection configuration		Set value
Connection I/O Type		Input / Output
Originator Device	Input Tag Set	D10100-[8 Byte]
	Connection type	Multi-cast connection
	Output Tag Set	D10000-[2 Byte]
	Connection type	Point to Point connection
Target Device	Output Tag Set	Input_100-[8 Byte]
	Input Tag Set	Output_148- [2 Byte]

- 4 Check that the settings are correct.
Click **Regist.**

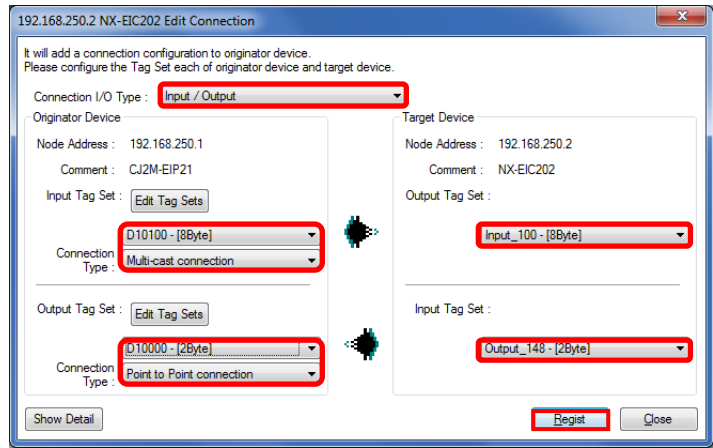

- 5 The Edit Connection Dialog Box is displayed again. Click **Close**.



- 6 The Edit Device Parameters Dialog Box is displayed again. Click **OK**.

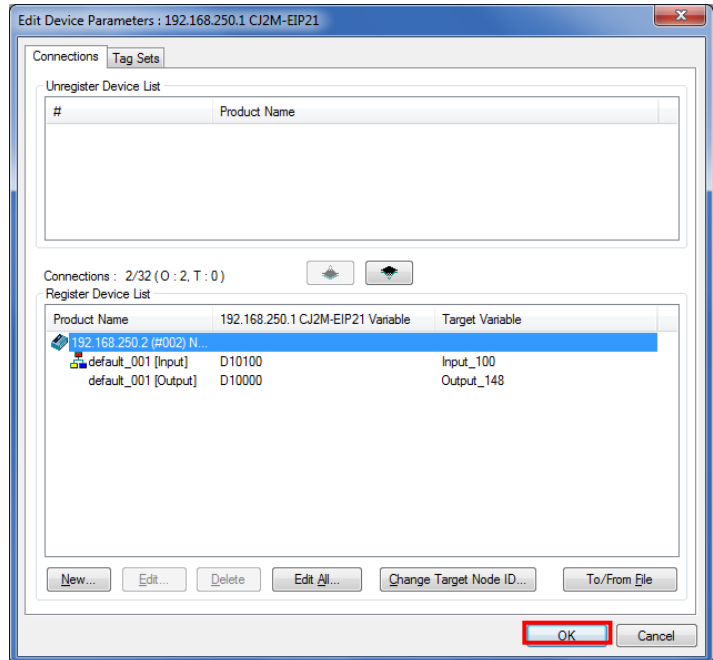

- 7 When the connection is completed, the registered node address is displayed under the device icon of node 2 in the Network Configuration Pane.

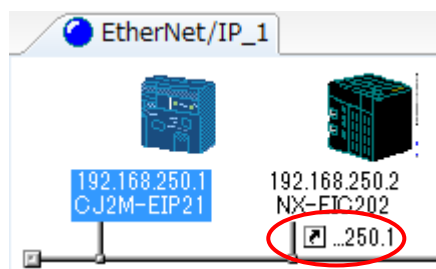

7.4.5. Transferring the Tag Data Link Parameters

Transfer the set tag data link parameters to PLC.

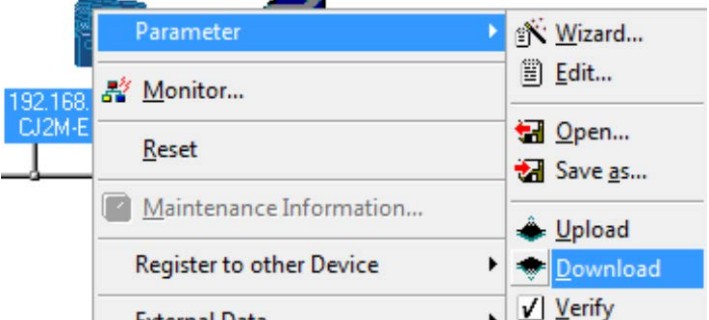
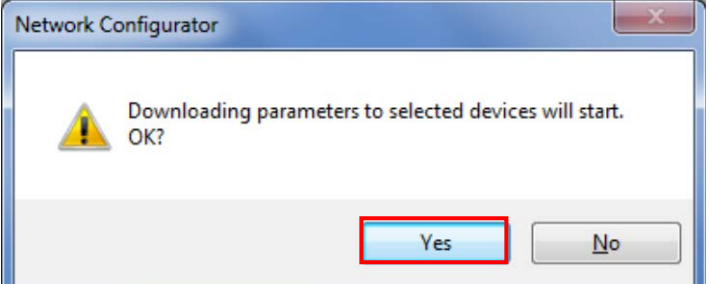
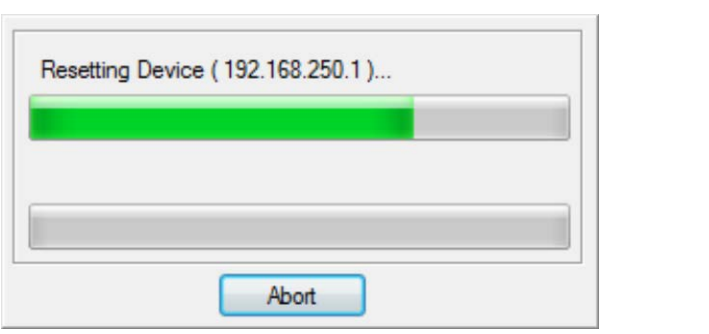
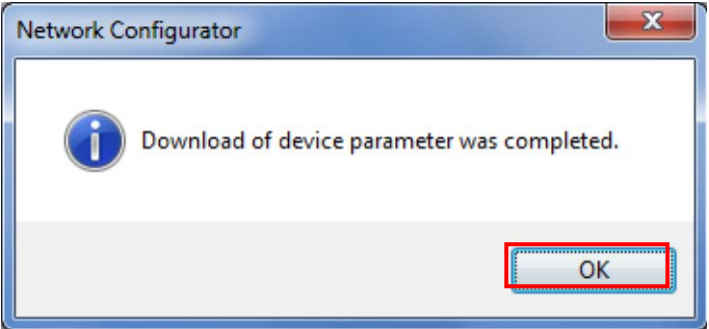
<p>1 Right-click the device icon of node 1 in the Network Configuration Pane and select Parameter - Download.</p>	
<p>2 The dialog box on the right is displayed. Confirm that there is no problem, and click Yes.</p>	
<p>3 The tag data link parameters are downloaded from Network Configurator to PLC.</p>	
<p>4 The dialog box on the right is displayed. Check the contents and click OK.</p>	

7.5. EtherNet/IP Communication Status Check

Confirm that the EtherNet/IP tag data links operate normally.

7.5.1. Checking the Connection Status

Check the connection status of the EtherNet/IP network.

- 1 Turn ON I/O power supply for Slave Terminal.

- 2 Check with LED indicators on PLC (EtherNet/IP Unit) that the EtherNet/IP tag data links operate normally.

The LED indicators in normal status are as follows:

MS: Green lit

NS: Green lit

COMM: Yellow lit

100M or 10M: Yellow lit



- 3 Check the LED indicators on Coupler Unit.

The LED indicators in normal status are as follows:

UNIT PWR: Green lit

I/O PWR: Green lit

L/A P1: Green lit

TS: Green lit

MS: Green lit

NS: Green lit

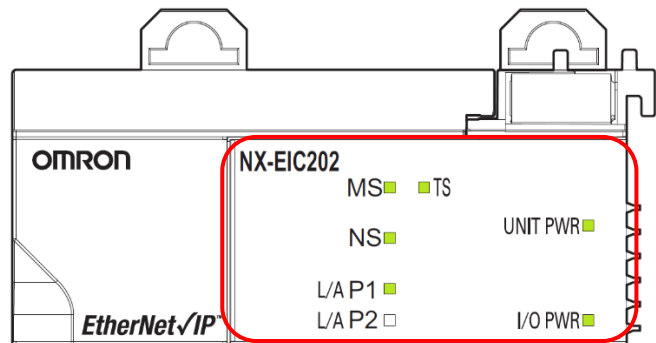

- 4 The normal operation of tag data links is confirmed through the status information in the Monitor Device Dialog Box of Network Configurator.

Right-click the device icon of node 1 in the Network Configuration Pane and select **Monitor**.

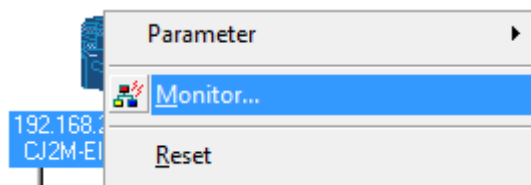

- 5 The dialog box on the right displays the Status 1 Tab Page in the Monitor Device Dialog Box.

When the same check boxes are selected as shown on the right, the tag data links are normally in operation.

Click **Close**.

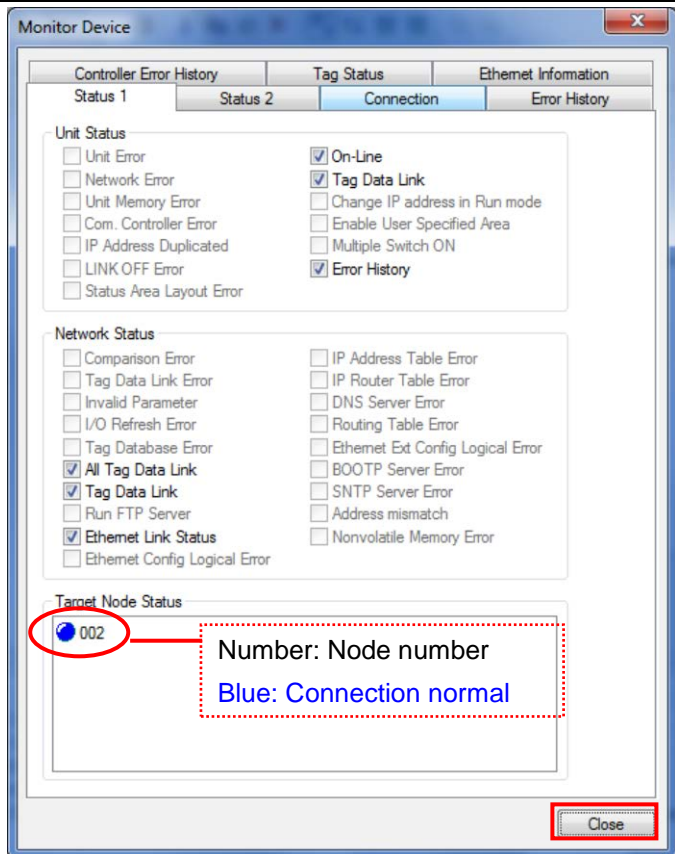

- 6 Select **Disconnect** from the Network Menu to go offline.

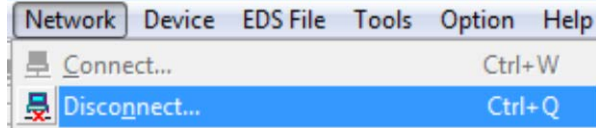

- 7 The color of the icon changes from blue to gray as shown on the right.

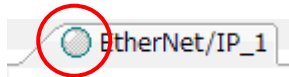

- 8 Select **Exit** from the File Menu to close Network Configurator.

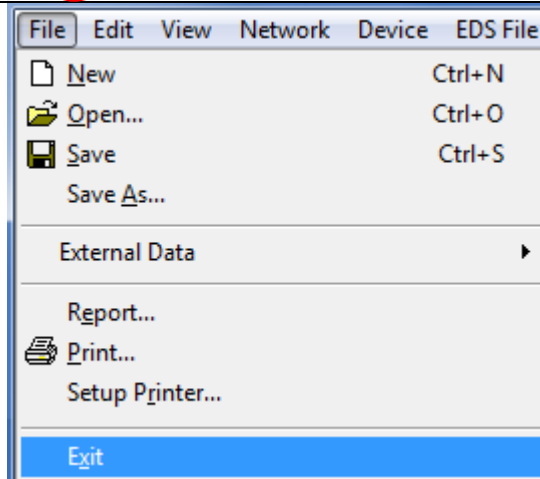

7.5.2. Checking the Sent and Received Data

Check that the correct data are sent and received.

Caution

In this procedure, the output of Slave Terminal is performed, which may have a risk of unexpected operation of Slave Terminal.

Take adequate safety precautions before you proceed with this operation check described here. If you cannot ensure safety, do not proceed. When you perform this operation check, make sure to complete all the steps and make the output of Slave Terminal safe.



Caution

Ensure the safety before wiring the I/O in a state where the devices are powered OFF. Always read and follow the information provided in all safety precautions in the manuals for each device to be wired.



Caution

If the PLC memory is changed by malfunction during monitoring power flow and present value status in the Ladder Section Window or in the Watch Window, the devices connected to output units may malfunction, regardless of the operating mode of CPU Unit.

Always ensure safety before monitoring power flow and present value status in the Ladder Section Window or in the Watch Window.



- 1 Check that the operating mode of PLC is in Stop/Program Mode.

*If the PLC is not in Stop/Program Mode, change to Stop/Program Mode by referring to *step 1* of *7.3.3. Creating the I/O Table and setting IP Address.*

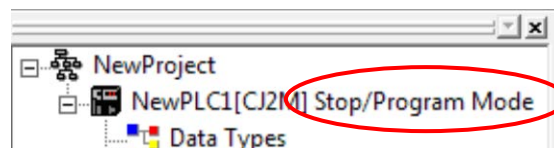

2 Select **Edit - Memory** from the PLC Menu.

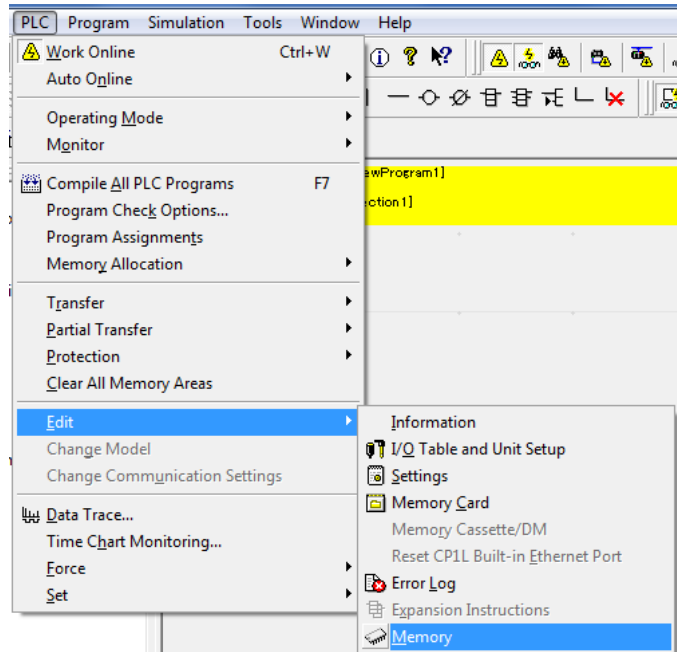

3 The PLC Memory Window is displayed. Double-click **D** on the **Memory Tab** of the PLC Memory Window.

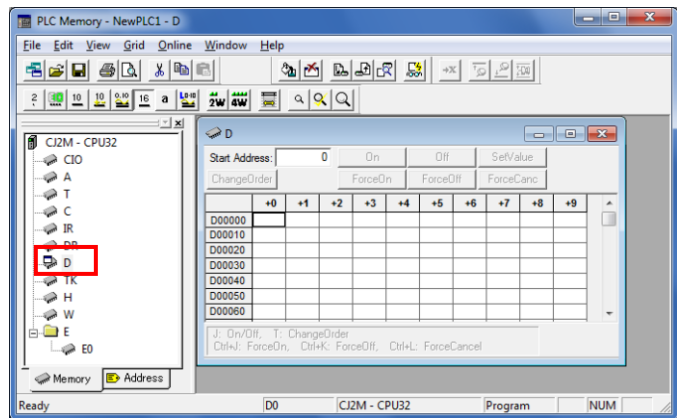

4 Select **Display - Binary** from the View Menu.

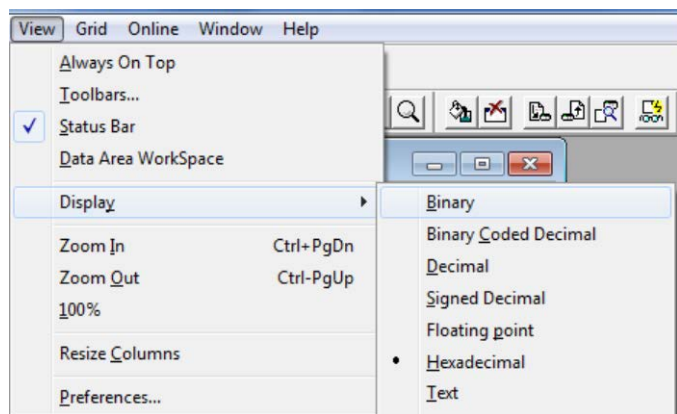

5 Select **Monitor** from the Online Menu.

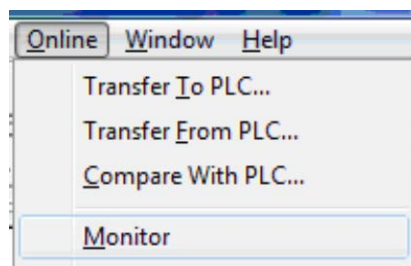

- 6 The Monitor Memory Areas Dialog Box is displayed. Check that D is selected. Click **Monitor**.

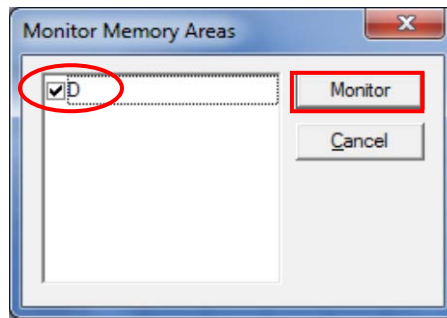

- 7 Enter 10000 in the *Start Address* Field of the D Window.

Check that the start address changes to D10000.

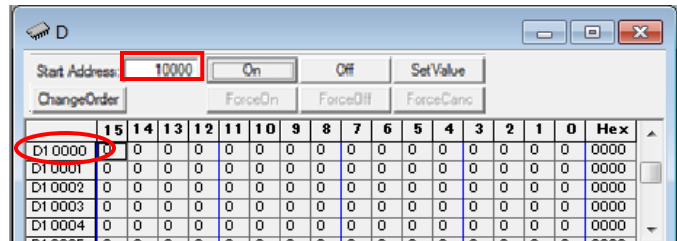

- 8 Select the bit 0 value of D10000 (digital output 0) and click **On**.

The bit 0 value of D10000 (digital output 0) changes to 1.

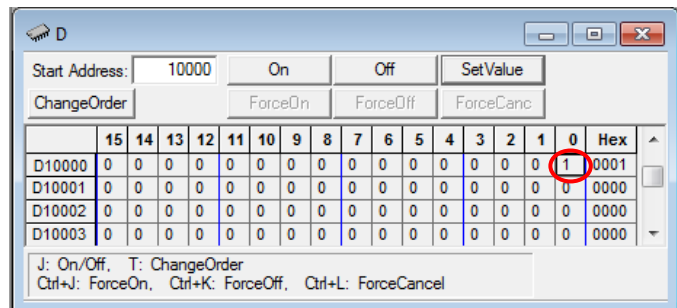
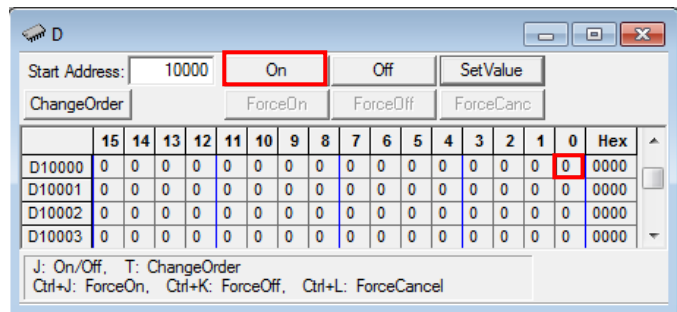

- 9 Enter 10100 in the *Start Address* Field.

Check that the start address changes to D10100.

Check that the bit 0 value of D10101 (digital input 0) shows 1.

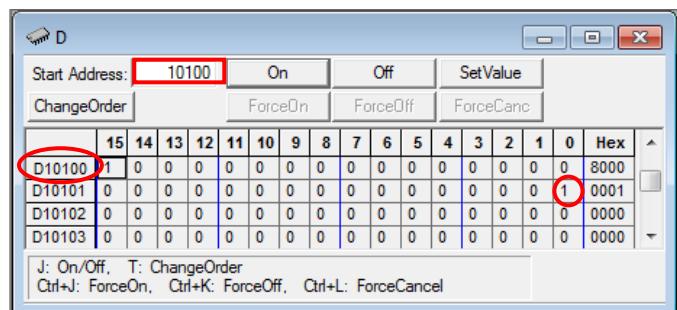

- 10 Check that the LED status of Digital Input Unit and Digital Output Unit is as shown below.
 Digital input 0: Lit
 Digital output 0: Lit



Digital Input Unit Digital Output Unit

- 11 Enter 10000 in the Start Address Field of the D Window.
 Check that the start address changes to D10000.

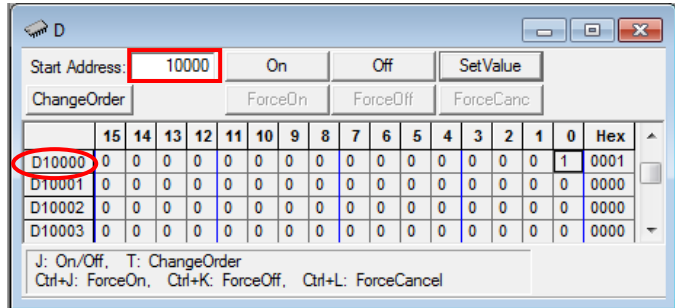

- 12 Select the bit 0 value of D10000 (digital output 0) and click Off.

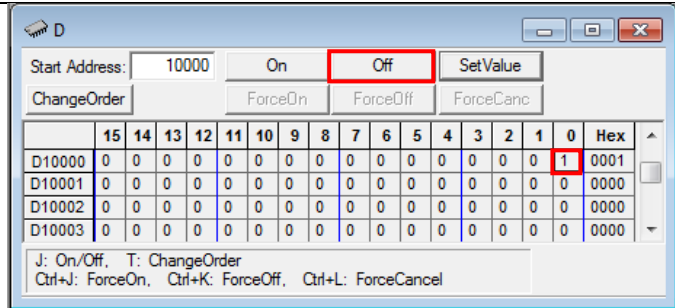

The bit 0 value of D10000 (digital output 0) changes to 0.

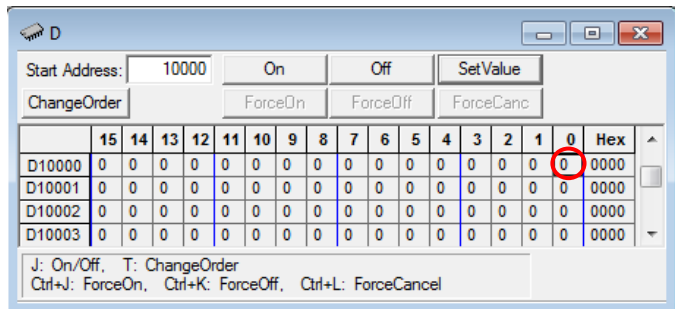

- 13 Enter 10100 in the Start Address Field.
 Check that the start address changes to D10100.

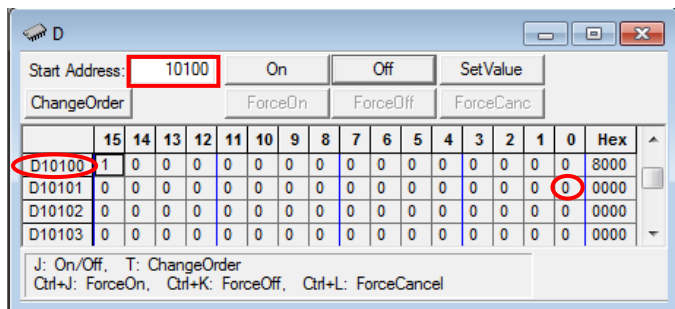

Check that the bit 0 value of D10101 (digital input 0) shows 0.

- 14 Check that the LED status of Digital Input Unit and Digital Output Unit is as shown below.
 Digital input 0: Not lit
 Digital output 0: Not lit



Digital Input Unit Digital Output Unit

8. Initialization Method

The setting procedures in this document are based on the factory default settings. Some settings may not be applicable unless you use the devices with the factory default settings.

8.1. Initializing PLC

To initialize the PLC settings, it is necessary to initialize EtherNet/IP Unit and CPU Unit. Change the operating mode of PLC to PROGRAM mode before the initialization.

8.1.1. EtherNet/IP Unit

To initialize the EtherNet/IP Unit settings, select **Edit - I/O Table and Unit Setup** from the PLC Menu in CX-Programmer, and follow the steps below.

(1) Right-click EtherNet/IP Unit in the PLC IO Table Window and select **Unit Setup** from the menu.

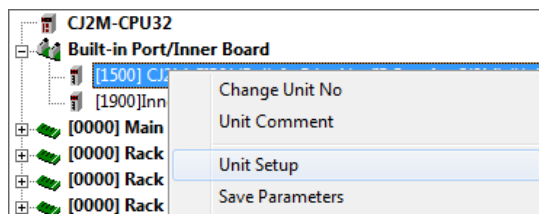

(2) Click **Restart** in the Edit Parameters Dialog Box.

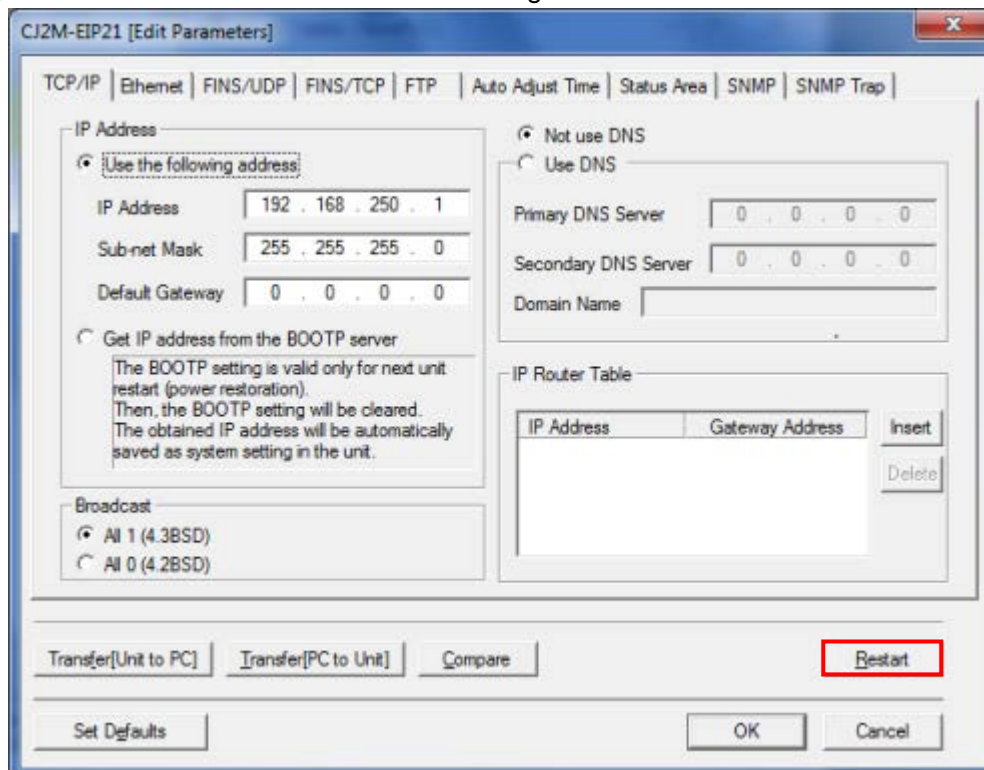

(3) An execution confirmation dialog box is displayed. Confirm that there is no problem, and click **Yes**.

(4)The Restart Unit Dialog Box is displayed. Select *Return to out-of-box configuration, and then emulate cycling power*, and click **OK**.

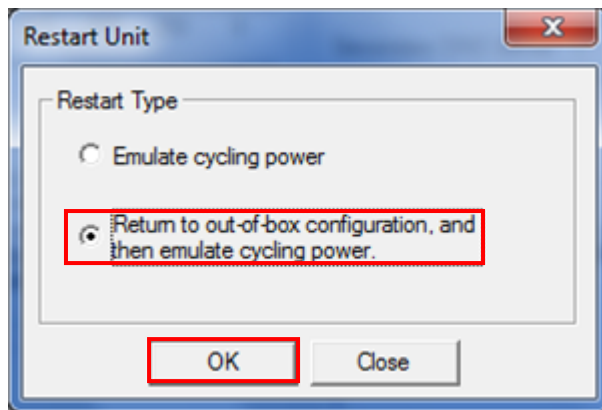

(5)A dialog box is displayed indicating that the execution is completed. Check the contents and click **OK**.

8.1.2. CPU Unit

To initialize the CPU Unit settings, select **Clear All Memory Areas** from the PLC Menu in CX-Programmer. Select *Initialize* in the Confirm All Memory Area Clear Dialog Box and click **OK**.

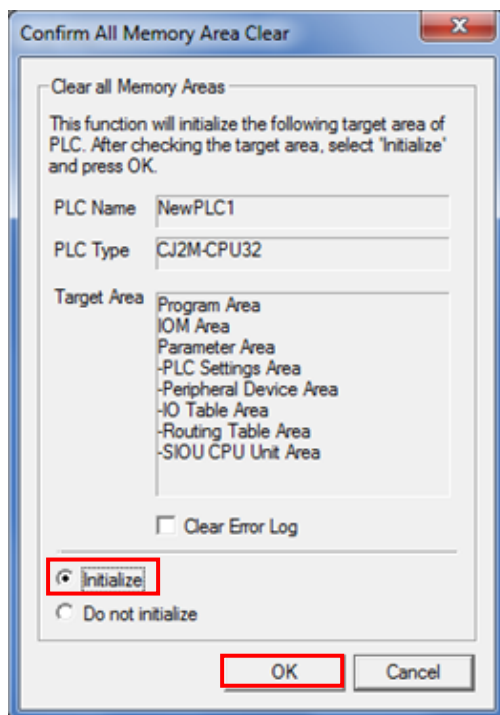

8.2. Initialization of Slave Terminal

For information on how to initialize Slave Terminal, refer to *11-4 Clearing All Memory of the NX-series EtherNet/IP™ Coupler Unit User's Manual (W536)*.

9. Revision History

Revision code	Date of revision	Description of revision
01	July 14, 2016	First edition

OMRON Corporation Industrial Automation Company

Tokyo, JAPAN

Contact: www.ia.omron.com

Regional Headquarters

OMRON EUROPE B.V.

Wegalaan 67-69, 2132 JD Hoofddorp
The Netherlands
Tel: (31)2356-81-300/Fax: (31)2356-81-388

OMRON ELECTRONICS LLC

2895 Greenspoint Parkway, Suite 200
Hoffman Estates, IL 60169 U.S.A
Tel: (1) 847-843-7900/Fax: (1) 847-843-7787

OMRON ASIA PACIFIC PTE. LTD.

No. 438A Alexandra Road # 05-05/08 (Lobby 2),
Alexandra Technopark,
Singapore 119967
Tel: (65) 6835-3011/Fax: (65) 6835-2711

OMRON (CHINA) CO., LTD.

Room 2211, Bank of China Tower,
200 Yin Cheng Zhong Road,
PuDong New Area, Shanghai, 200120, China
Tel: (86) 21-5037-2222/Fax: (86) 21-5037-2200

Authorized Distributor:

© OMRON Corporation 2016 All Rights Reserved.
In the interest of product improvement,
specifications are subject to change without notice.

Cat. No. P656-E1-01

0716-(-)