

Machine Automation Controller NJ-series

# EtherNet/IP™ Connection Guide

## OMRON Corporation

RFID Reader/Writer  
(V680S-series)

Network  
Connection  
Guide

### **About Intellectual Property Rights and Trademarks**

---

Microsoft product screen shots reprinted with permission from Microsoft Corporation.

Windows is a registered trademark of Microsoft Corporation in the USA and other countries.

ODVA and EtherNet/IP™ are trademarks of ODVA.

EtherCAT(R) is registered trademark and patented technology, licensed by Beckhoff Automation GmbH, Germany.

Sysmac is a trademark or registered trademark of OMRON Corporation in Japan and other countries for OMRON factory automation products.

Company names and product names in this document are the trademarks or registered trademarks of their respective companies.

---

## Table of Contents

<b>1. Related Manuals</b> .....	<b>1</b>
<b>2. Terms and Definitions</b> .....	<b>2</b>
<b>3. Precautions</b> .....	<b>4</b>
<b>4. Overview</b> .....	<b>5</b>
<b>5. Applicable Devices and Device Configuration</b> .....	<b>6</b>
5.1. Applicable Devices .....	6
5.2. Device Configuration .....	7
<b>6. EtherNet/IP Settings</b> .....	<b>9</b>
6.1. Parameters .....	9
6.2. Global Variables .....	10
6.3. Tag Sets .....	11
6.4. Tag Data Link Table .....	11
<b>7. EtherNet/IP Connection Procedure</b> .....	<b>12</b>
7.1. Work Flow .....	12
7.2. Setting up RFID Reader/Writer .....	13
7.3. Setting up Controller .....	17
7.4. Checking the EtherNet/IP Communications .....	32
<b>8. Initialization Method</b> .....	<b>39</b>
8.1. Initializing Controller .....	39
8.2. Initializing RFID Reader/Writer .....	39
<b>9. Appendix 1 Procedure Using the Project File</b> .....	<b>40</b>
9.1. Work Flow .....	40
9.2. Setting up Controller .....	41
<b>10. Appendix 2 Setting the Tag Data Links</b> .....	<b>43</b>
10.1. Global Variables .....	43
10.2. Tag Sets .....	44
10.3. Tag Data Link Table .....	45
<b>11. Revision History</b> .....	<b>46</b>

## 1. Related Manuals

To ensure system safety, make sure to always read and heed the information provided in all Safety Precautions and Precautions for Safe Use of manuals for each device which is used in the system.

Cat. No.	Model	Manual name
W500	NJ501-□□□□ NJ301-□□□□	NJ-series CPU Unit Hardware User's Manual
W501	NJ501-□□□□ NJ301-□□□□	NJ-series CPU Unit Software User's Manual
W506	NJ501-□□□□ NJ301-□□□□	NJ Series CPU Unit Built-in EtherNet/IP™ Port User's Manual
W504	SYSMAC-SE2□□□□	Sysmac Studio Version 1 Operation Manual
0969584-7	W4S1-05□ W4S1-03B	Switching Hub W4S1-series Users Manual
Z353	V680S-HMD63-EIP V680S-HMD64-EIP V680S-HMD66-EIP	V680S Series User's Manual (EtherNet/IP™) Reader/Writer

## 2. Terms and Definitions

Term	Explanation and Definition
Node	<p>Controllers and devices are connected to the EtherNet/IP network via the EtherNet/IP ports. EtherNet/IP recognizes each EtherNet/IP port connected to the network as one node.</p> <p>When a device with two EtherNet/IP ports is connected to the EtherNet/IP network, EtherNet/IP recognizes this device as two nodes.</p> <p>EtherNet/IP achieves the communications between controllers or the communications between controllers and devices by exchanging data between these nodes connected to the network.</p>
Tag	<p>A minimum unit of the data that is exchanged on the EtherNet/IP network is called a tag. The tag is defined as a network variable or as a physical address, and it is allocated to the memory area of each device.</p>
Tag set	<p>In the EtherNet/IP network, a data unit that consists of two or more tags can be exchanged. The data unit consisting of two or more tags for the data exchange is called a tag set. Up to eight tags can be configured per tag set for OMRON controllers.</p>
Tag data link	<p>In EtherNet/IP, the tag and tag set can be exchanged cyclically between nodes without using the user program. This standard feature on EtherNet/IP is called a tag data link.</p>
Connection	<p>A connection is used to exchange data as a unit within which data concurrency is maintained. The connection consists of tags or tag sets. Creating the concurrent tag data link between the specified nodes is called a "connection establishment". When the connection is established, the tags or tag sets that configure the connection are exchanged between the specified nodes concurrently.</p> <p>Specifying the tag set name (tag name) and specifying the instance number of Assembly Object are given as methods to specify the connection.</p> <p>In Sysmac Studio, the connection is set by specifying the instance number.</p>
Connection type	<p>There are two kinds of connection types for the tag data link connection, one is a multi-cast connection and the other is a unicast (point-to-point) connection. The multi-cast connection sends an output tag set in one packet to multiple nodes. The unicast connection separately sends one output tag set to each node. Therefore, multi-cast connections can decrease the communications load if one output tag set is sent to multiple nodes.</p>

Originator and Target	<p>To perform tag data links, one node requests the opening of a communications line called a "connection".</p> <p>The node that requests to open the connection is called an "originator", and the node that receives the request is called a "target".</p> <p>Each data for communications is called an "originator variable" and a "target variable".</p> <p>In Sysmac Studio, the instance number is specified in the target variable.</p>
Tag data link parameter	<p>The tag data link parameter is the setting data to perform the tag data link. It includes the data to set tags, tag sets, and connections.</p>
EDS file	<p>A file that describes the number of I/O points for the EtherNet/IP device and the parameters that can be set via EtherNet/IP.</p>
Operation mode (RFID Reader/Writer)	<p>V680S-series RFID Reader/Writer has three operation modes: Run Mode, Safe Mode, and Slave Mode.</p> <ul style="list-style-type: none"> <li>■Run Mode           <p>An operation mode that performs in the commands from the host device.</p> </li> <li>■Safe Mode           <p>An operation mode that starts with fixed IP settings when you do not remember the IP address that is set in RFID Reader/Writer.</p> </li> <li>■Slave Mode           <p>An operation mode that performs according to instructions from Master Reader/Writer when you use the multi-Reader/Writer functions.</p> </li> </ul>
Communications option (RFID Reader/Writer)	<p>The V680S-series Reader/Writer has three communications options to communicate with RF Tags: Once, Repeat, and FIFO Repeat.</p> <ul style="list-style-type: none"> <li>■Once           <p>The Reader/Writer communicates with RF Tags for command execution requests from the host device. When the Reader/Writer is finished communicating with an RF Tag, it returns the communications results to the host device and waits for another command.</p> </li> <li>■Repeat           <p>When the Reader/Writer receives a command execution request from the host device, it automatically detects RF Tags in the communications field and communicates with them. This process is repeated until the execution request is cleared. Communications are not performed for RF Tags that have returned communications results to the host device until the RF Tags leave the communications field.</p> </li> <li>■FIFO Repeat           <p>When the Reader/Writer receives a command execution request from the host device, it automatically detects RF Tags in the communications field and communicates with them. After successfully communicating with an RF Tag once, operation for that RF Tag is stopped. This process is repeated until the execution request is cleared. Communications are not performed for RF Tags that have returned communications results to the host device until the RF Tags leave the communications field.</p> </li> </ul>

## 3. Precautions

- (1) Understand the specifications of devices which are used in the system. Allow some margin for ratings and performance. Provide safety measures, such as installing safety circuit, in order to ensure safety and minimize risks of abnormal occurrence.
- (2) To ensure system safety, make sure to always read and heed the information provided in all Safety Precautions and Precautions for Safe Use of manuals for each device which is used in the system.
- (3) The user is encouraged to confirm the standards and regulations that the system must conform to.
- (4) It is prohibited to copy, to reproduce, and to distribute a part or the whole of this document without the permission of OMRON Corporation.
- (5) The information contained in this document is current as of June 2015. It is subject to change without notice for improvement.

The following notations are used in this document.



**WARNING**

Indicates a potentially hazardous situation which, if not avoided, will result in minor or moderate injury, or may result in serious injury or death. Additionally there may be significant property damage.



**Caution**

Indicates a potentially hazardous situation which, if not avoided, may result in minor or moderate injury or property damage.



### Precautions for Correct Use

Precautions on what to do and what not to do to ensure proper operation and performance.



### Additional Information

Additional information to read as required.

This information is provided to increase understanding or make operation easier.

### Symbol



The filled circle symbol indicates operations that you must do.  
The specific operation is shown in the circle and explained in text.  
This example shows a general precaution for something that must do.

## 4. Overview

This document describes the procedure for connecting V680S-series RFID Reader/Writer (hereinafter referred to as RFID Reader/Writer) of OMRON Corporation (hereinafter referred to as OMRON) to NJ-series Machine Automation Controller (hereinafter referred to as Controller) via EtherNet/IP and provides the procedure for checking their connection. Refer to *Section 6. EtherNet/IP Settings* and *Section 7. EtherNet/IP Connection Procedure* to understand the setting method and key points to perform the tag data links for EtherNet/IP.



### Additional Information

Settings which are described in *7.3. Setting up Controller* are set in advance into the Sysmac Studio compact project file (hereinafter referred to as project file). Refer to *Section 9. Appendix 1 Procedure Using the Project File* for usage method of the project file. Obtain the latest project file from OMRON.

Name	File name	Version
Sysmac Studio compact project file (Extension: csm2)	OMRON_V680S_EIP_EV100.csm2	Ver.1.00



## 5. Applicable Devices and Device Configuration

### 5.1. Applicable Devices

The applicable devices are as follows:

Manufacturer	Name	Model
OMRON	NJ-series CPU Unit	NJ501-□□□□ NJ301-□□□□
OMRON	RFID Reader/Writer	V680S-HMD63-EIP V680S-HMD64-EIP V680S-HMD66-EIP



#### Precautions for Correct Use

As applicable devices above, the devices with the models and versions listed in 5.2. *Device Configuration* are actually used in this document to describe the procedure for connecting devices and checking the connection.

You cannot use devices with versions lower than the versions listed in 5.2.

To use the above devices with models not listed in 5.2. or versions higher than those listed in 5.2., check the differences in the specifications by referring to the manuals before operating the devices.



#### Additional Information

This document describes the procedure to establish the network connection. It does not provide information on operation, installation or wiring method which is not related to the connection procedure. It also does not describe the functionality or operation of the devices. Refer to the manuals or contact your OMRON representative.



#### Additional Information

For information on applicable RF Tags, refer to the *V680S Series User's Manual (EtherNet/IP™) Reader/Writer* (Cat. No. Z353).

**5.2. Device Configuration**

The hardware components to reproduce the connection procedure of this document are as follows:

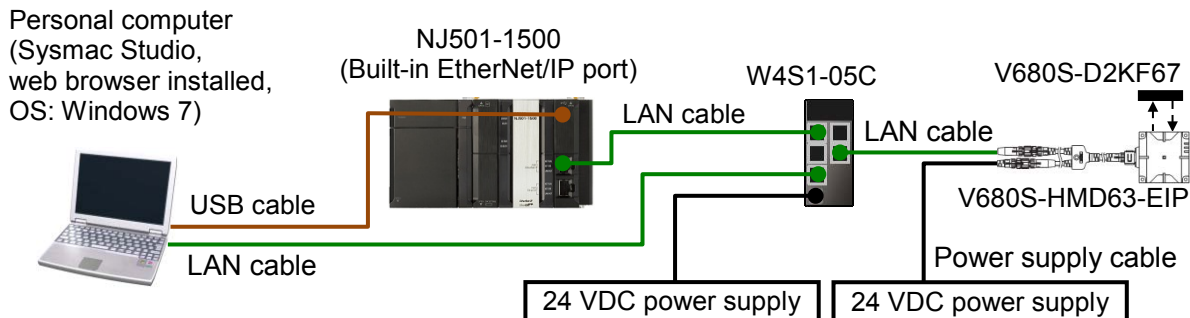

Manufacturer	Name	Model	Version
OMRON	NJ-series CPU Unit (Built-in EtherNet/IP port)	NJ501-1500	Ver. 1.10
OMRON	Power Supply Unit	NJ-PA3001	
OMRON	Switching hub	W4S1-05C	Ver.1.00
-	24 VDC power supply (For Switching hub)	-	
OMRON	Sysmac Studio	SYSMAC-SE2□□□□	Ver.1.12
-	Personal computer (OS: Windows 7)	-	
-	Web browser	-	
-	USB cable (USB 2.0 type B connector)	-	
-	LAN cable (STP (shielded, twisted-pair) cable of Ethernet category 5 or higher)	-	
OMRON	RFID Reader/Writer	V680S-HMD63-EIP	Ver.3.00
OMRON	RF Tag	V680S-D2KF67	
OMRON	LAN cable (With M12/RJ45 connector) (For RFID Reader/Writer)	XS5W-series	
OMRON	Power supply cable (With M12 connector) (For RFID Reader/Writer)	XS2F-series	
-	24 VDC power supply (For RFID Reader/Writer)	-	

**Precautions for Correct Use**

Update Sysmac Studio to the version specified in this clause or higher version using the auto update function. If a version not specified in this clause is used, the procedures described in Section 7. and subsequent sections may not be applicable. In that case, use the equivalent procedures described in this document by referring to the *Sysmac Studio Version 1 Operation Manual* (Cat. No. W504).



### **Additional Information**

---

For information on a web browser to use, refer to *Section 6. Browser Interface* of the *V680S Series User's Manual (EtherNet/IP™) Reader/Writer* (Cat. No. Z353).

---



### **Additional Information**

---

For specifications of 24 VDC power supply available for Switching hub, refer to the *Switching Hub W4S1-series Users Manual* (Cat. No. 0969584-7).

---



### **Additional Information**

---

For specifications of 24 VDC power supply available for RFID Reader/Writer, refer to the *V680S Series User's Manual (EtherNet/IP™) Reader/Writer* (Cat. No. Z353).

---



### **Additional Information**

---

The system configuration in this document uses USB for the connection to Controller.  
For information on how to install a USB driver, refer to *A-1 Driver Installation for Direct USB Cable Connection of the Sysmac Studio Version 1 Operation Manual* (Cat. No. W504).

---

## 6. EtherNet/IP Settings

This section describes the specifications of parameters, global variables, tag sets, and a tag data link table that are all defined in this document.

This document explains the settings and the connection procedures in a case where the data size to use for tag data links is 40 bytes. However, you can also select other bytes: 264, 520, and 1032 bytes as the data size. For use of other data sizes, refer to *Section 10. Appendix 2 Setting the Tag Data Links*.

Hereinafter, RFID Reader/Writer is referred to as "Destination Device" in some descriptions.

### 6.1. Parameters

The parameters that are set in this document are as follows:

#### 6.1.1. Communication Settings of Personal Computer

RFID Reader/Writer is set by using the Ethernet communications in a web browser of Personal computer for settings. The parameters for Personal computer and RFID Reader/Writer required for Ethernet communications are shown below.

Item	Personal computer for setting	RFID Reader/Writer
IP address	192.168.1.100	192.168.1.200 (default)
Subnet mask	255.255.255.0	255.255.255.0 (default)

#### 6.1.2. EtherNet/IP Communications Settings

The parameters required for connecting Controller and RFID Reader/Writer via EtherNet/IP are shown below.

Item	Controller	RFID Reader/Writer
IP address	192.168.250.1	192.168.250.2
Subnet mask	255.255.255.0	255.255.255.0 (default)
Communications option	-	Once (default)



#### Additional Information

For information on the communications options of RFID Reader/Writer, refer to the *V680S Series User's Manual (EtherNet/IP™) Reader/Writer (Cat. No. Z353)*.

## 6.2. Global Variables

The Controller treats the data in tag data links as global variables.

The settings of the global variables are the following.

Name	Data Type	Network Publish	Destination Device Allocation	Data Size (Byte)
EIP002_Control_OUT	BOOL[16]	Output	Command Area (Array of bit)	2
EIP002_CmdCode_OUT	WORD	Output	Command Code	2
EIP002_CmdParam1_OUT	WORD	Output	Command Parameter 1	2
EIP002_CmdParam2_OUT	WORD	Output	Command Parameter 2	2
EIP002_CmdData_OUT	WORD[16]	Output	Command Data	32
EIP002_Status_IN	BOOL[16]	Input	Response Area (Array of bit)	2
EIP002_ErrCode_IN	WORD	Input	Error Code	2
EIP002_ResplInfo1_IN	WORD	Input	Response Information 1	2
EIP002_ResplInfo2_IN	WORD	Input	Response Information 2	2
EIP002_RespData_IN	WORD[16]	Input	Response Data	32

### ■ Detailed explanation of Command Area (Array of bit)

Allocation

EIP002\_Control\_OUT  
[15] to [0]

15	14	13	12	11	10	9	8	7	6	5	4	3	2	1	0
Resv	Resv	Resv	Resv	Resv	Resv	Resv	Resv	Resv	Resv	Resv	Resv	Resv	Resv	Resv	EXE

### ■ Detailed explanation of Response Area (Array of bit)

Allocation

EIP002\_Status\_IN  
[15] to [0]

15	14	13	12	11	10	9	8	7	6	5	4	3	2	1	0
Resv	Resv	Resv	Resv	Resv	Resv	Resv	RF_W AR	SYS_ ERR	RF_E RR	CMD_ ERR	FRIC	ERR	NOR M	BUSY	READ Y



### Precautions for Correct Use

If the data size of tag data links for Destination Device is an odd-numbered byte, use BYTE type to define, do not use BOOL type.



### Additional Information

With Sysmac Studio, two methods can be used to specify an array for a data type. After specifying, (1) is converted to (2) and the data type is always displayed as (2).

(1) BOOL[16] / (2) ARRAY[0..15] OF BOOL

In this document, the data type is simplified by displaying BOOL[16].

(The example above means a BOOL data type with sixteen array elements.)

### 6.3. Tag Sets

The following provides the detailed settings of the tag sets to execute the processing for the tag data links.

Data in the tag sets are allocated in ascending order of OUT No. and IN No. listed below.

#### ■ Output area (from controller to RFID Reader/Writer)

Originator Variable (tag set name)		Data Size (Byte)
EIP002_OUT		40
OUT No.	Global Variable Name (tag name)	Data Size (Byte)
1	EIP002_Control_OUT	2
2	EIP002_CmdCode_OUT	2
3	EIP002_CmdParam1_OUT	2
4	EIP002_CmdParam2_OUT	2
5	EIP002_CmdData_OUT	32

#### ■ Input area (from RFID Reader/Writer to Controller)

Originator Variable (tag set name)		Data Size (Byte)
EIP002_IN		40
IN No.	Global Variable Name (tag name)	Data Size (Byte)
1	EIP002_Status_IN	2
2	EIP002_ErrCode_IN	2
3	EIP002_RespInfo1_IN	2
4	EIP002_RespInfo2_IN	2
5	EIP002_RespData_IN	32

### 6.4. Tag Data Link Table

The following describes the detailed settings of the tag data link table (connection settings). The values in a red frame are taken from the values in EDS file of Destination Device.

Connection Name	Connection I/O Type	RPI [ms]	Timeout Value
default_001	Consume Data From/Produce Data To:40	50.0	RPI x 4

Connection I/O Type	Input / Output	Target Variable (set value of Destination Device: instance number)	Size (Byte)	Originator Variable (tag set name)	Size (Byte)	Connection Type
Consume Data From/Produce Data To:40	Input	110	40	EIP002_IN	40	Point to Point connection
	Output	100	40	EIP002_OUT	40	Point to Point connection

## 7. EtherNet/IP Connection Procedure

This section describes the procedure for connecting RFID Reader/Writer and Controller on the EtherNet/IP network. This document provides the explanation of the procedure for setting up Controller and RFID Reader/Writer based on the factory default setting. For the initialization, refer to *Section 8. Initialization Method*.

### 7.1. Work Flow

Take the following steps to set the tag data links for EtherNet/IP.

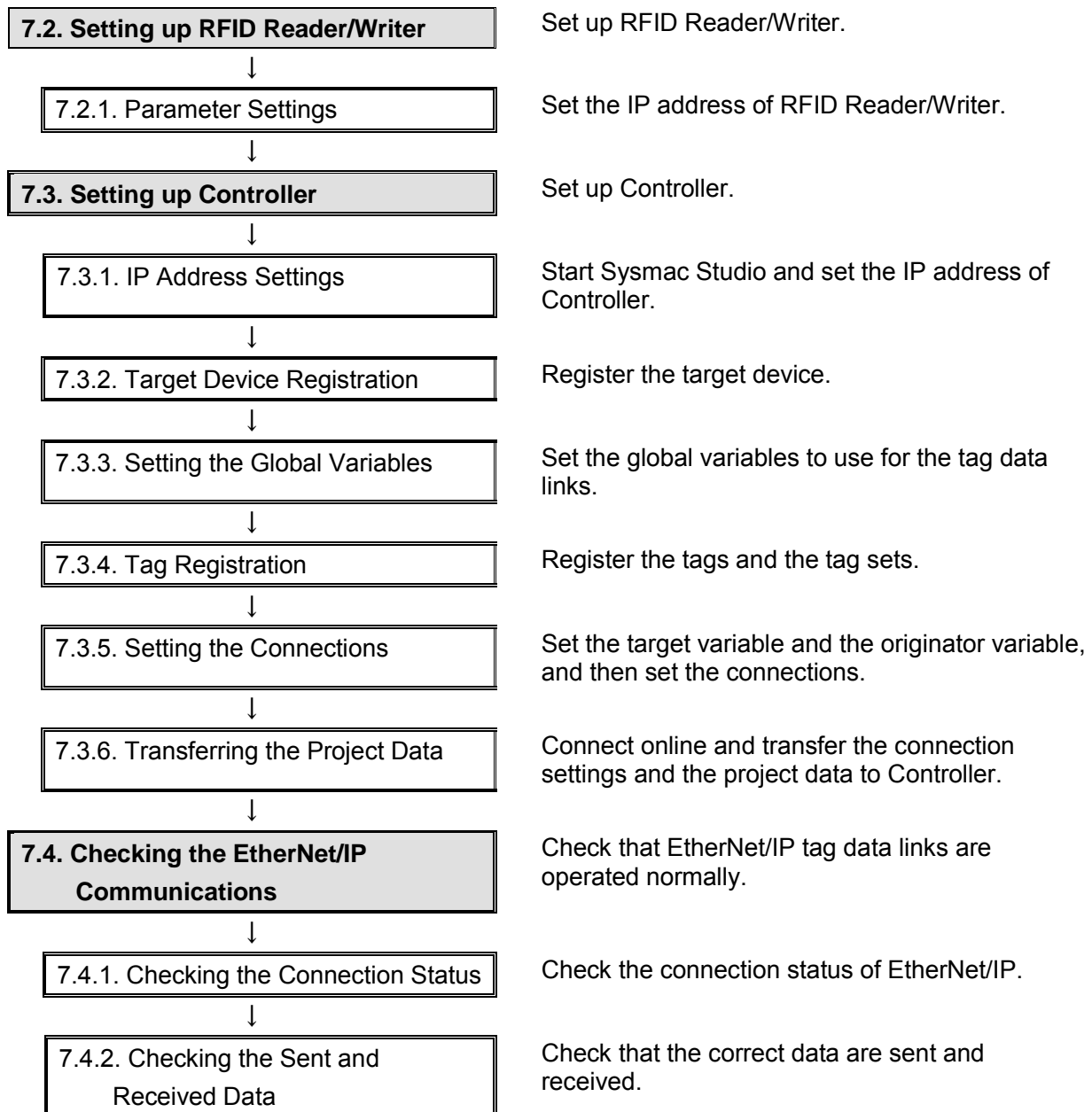

## 7.2. Setting up RFID Reader/Writer

Set up RFID Reader/Writer.

### 7.2.1. Parameter Settings

Set the IP address of RFID Reader/Writer.

Set the IP address of Personal computer to 192.168.1.100.

A web browser is used in the parameter settings for RFID Reader/Writer.

Check if you can use a web browser on Personal computer.



#### Precautions for Correct Use

Set the parameters for RFID Reader/Writer by using the Ethernet communications of Personal computer.

Note that you may need to change the settings of Personal computer depending on the status of Personal computer.



#### Precautions for Correct Use

If RFID Reader/Writer was changed from the factory default setting, make sure to start in Safe Mode. The IP address is always 192.168.1.200. For information on starting in Safe Mode, refer to *Connector* in *Section 2. Names and Functions of Components of the V680S Series User's Manual (EtherNet/IP™) Reader/Writer* (Cat. No. Z353).

- 1 Make sure that the power supply to the each device is OFF.  
Connect Personal computer, Controller, and RFID Reader/Writer with LAN cables via Switching hub by referring to the right figure.  
Connect Personal computer to Controller with USB cable.  
Connect 24 VDC power supplies separately to Switching hub and RFID Reader/Writer

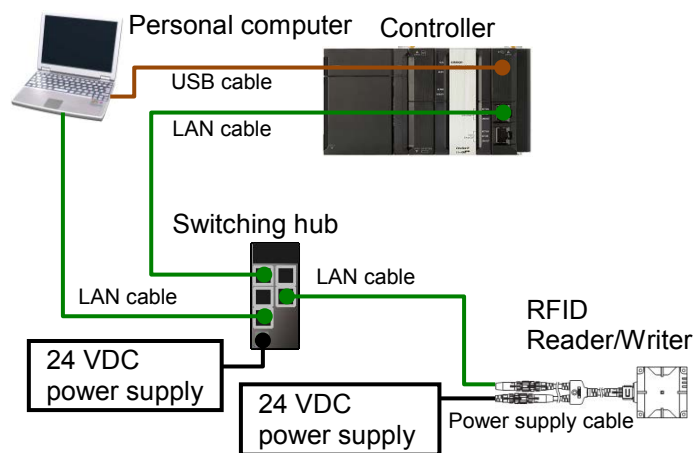

- 2 Turn ON the power supply to Personal computer, RFID Reader/Writer, and Switching hub.



- 3 Set the IP address of Personal computer to 192.168.1.100.

\*Take the following procedure to change the IP address of Personal computer.

- (1) Start Personal computer and login as administrator. Then open Control Panel from the start menu, select **Network and Internet - Network and Sharing Center - Change Adapter Settings**, and double-click **Local Area Connection**.

\*The operating procedure may differ depending on the environment of Personal computer.

- (2) The Local Area Connection Status Dialog Box is displayed. Click **Properties**.

- (3) The Local Area Connection Properties Dialog Box is displayed. Select **Internet Protocol Version 4 (TCP-IPv4)**, and click **Properties**.

\*The display differs depending on the configuration of Personal computer.

- (4) The Internet Protocol Version 4 (TCP/IPv4) Properties Dialog Box is displayed. Select **Use the following IP address**, enter 192.168.1.100 as the IP address and 255.255.255.0 as the subnet mask, and click **OK**.

- (5) Close all dialog boxes by clicking **Close** or **OK**.

Screen of (2)

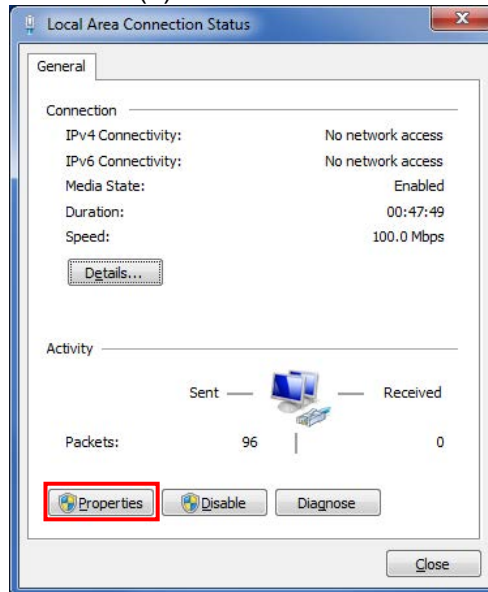

Screen of (3)

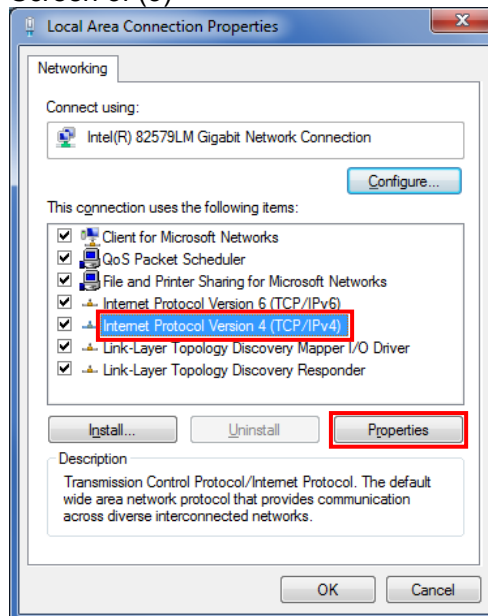

Screen of (4)

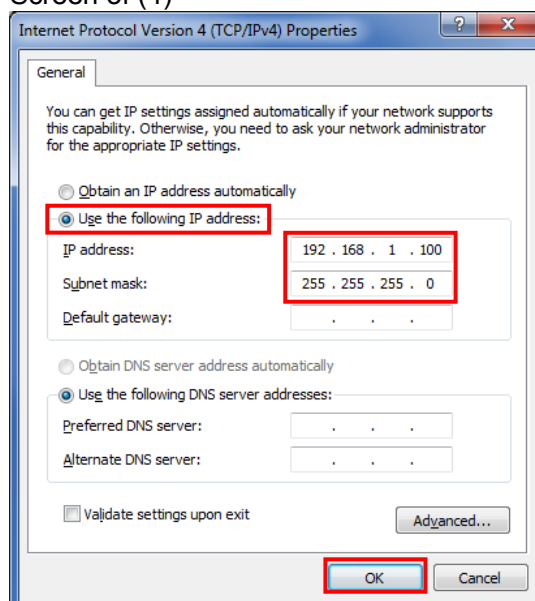

- 4 Start a web browser on Personal computer and type *http://192.168.1.200* in the address bar.

The setting window for V680S RFID Reader/Writer is displayed.

\*You can select a display language from the pull-down list which is displayed on the upper right of the browser operation window. In this document, English for default is used.

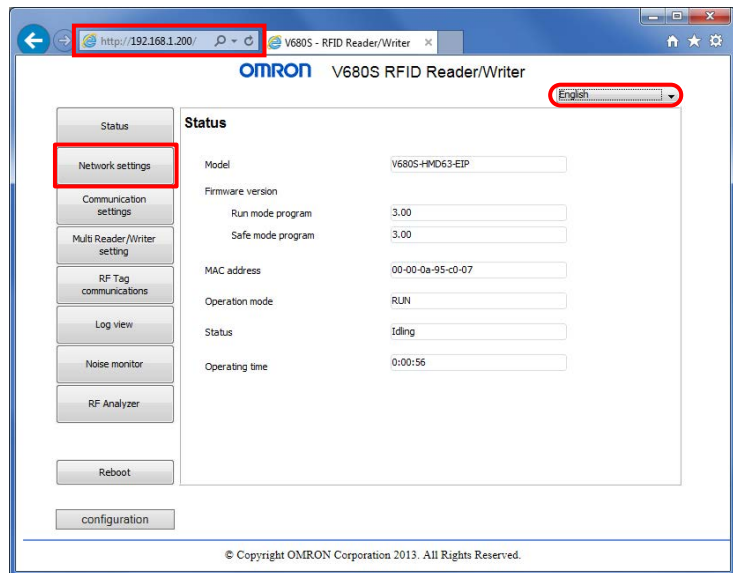

Click **Network settings**.

- 5 Network settings is displayed. Set the following values and click **Set**.

- IP address: *192.168.250.2*
- Subnet mask: *255.255.255.0*

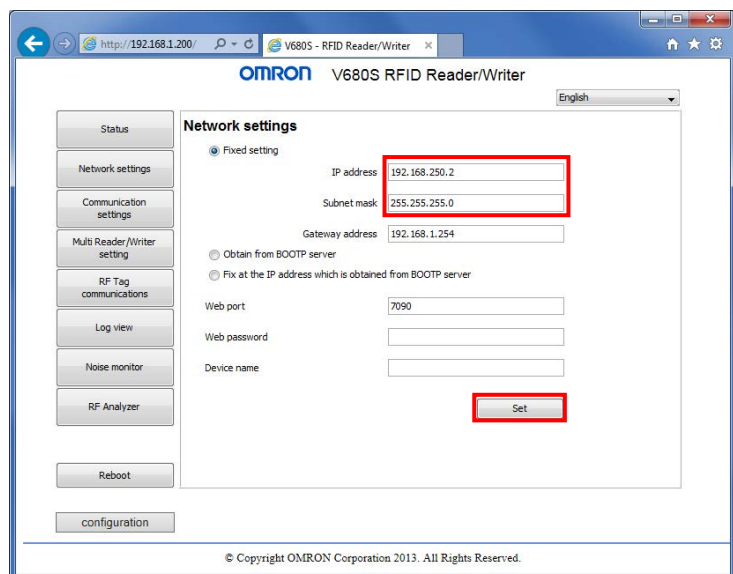

- 6 A confirmation dialog box is displayed as shown on the right. Check the contents and click **Yes**.

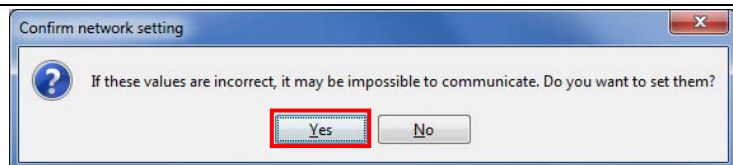

- 7 A confirmation dialog box is displayed as shown on the right. Check the contents and click **OK**.

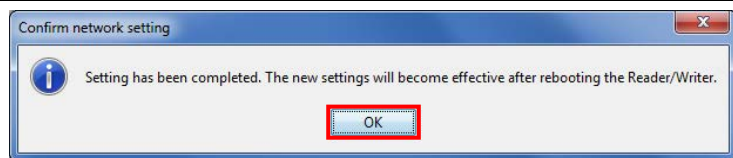

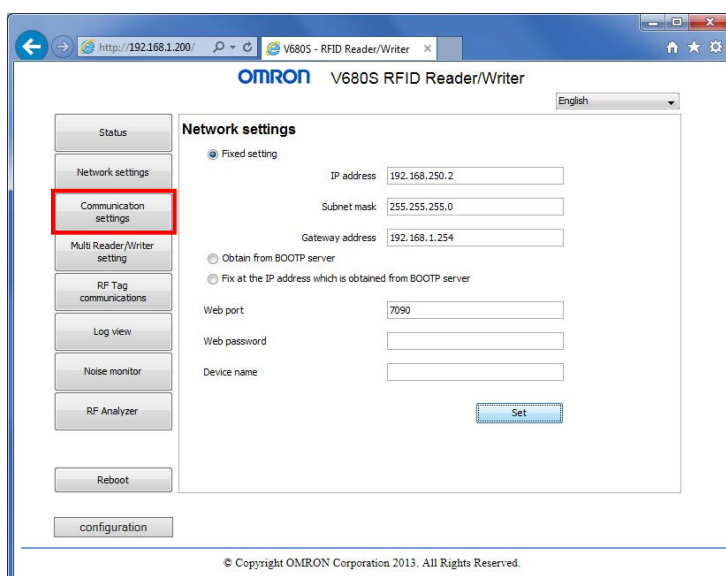
8 Click **Communication settings**.9 RF Tag communication settings is displayed. Check that **Once** is selected for RF Tag communications option.

\*If RF Tag communications option is not **Once**, select **Once** from the pull-down list, and click **Set**. A dialog box for the setting change is displayed. Check the contents and click **OK**.

\* For details on RF Tag communications option, refer to *Communications Options in RF Tag Communications in Functions in Section 2. Names and Functions of Components of the V680S Series User's Manual (EtherNet/IP™) Reader/Writer (Cat. No. Z353)*.

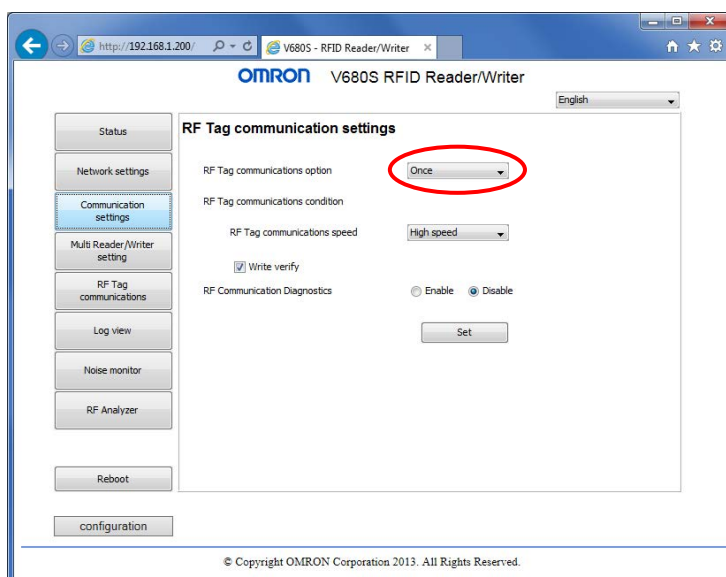

## 10 Close the web browser.

## 11 Cycle the power supply to RFID Reader/Writer.

\*The settings become effective by cycling the power supply.

### 7.3. Setting up Controller

Set up Controller.

#### 7.3.1. IP Address Settings

Start Sysmac Studio and set the IP address of Controller.

Install Sysmac Studio and a USB driver in Personal computer beforehand.

1 Start Sysmac Studio.

\*If a confirmation dialog for an access right is displayed at start, execute a selection to start.



2 Sysmac Studio starts.  
Click **New Project**.

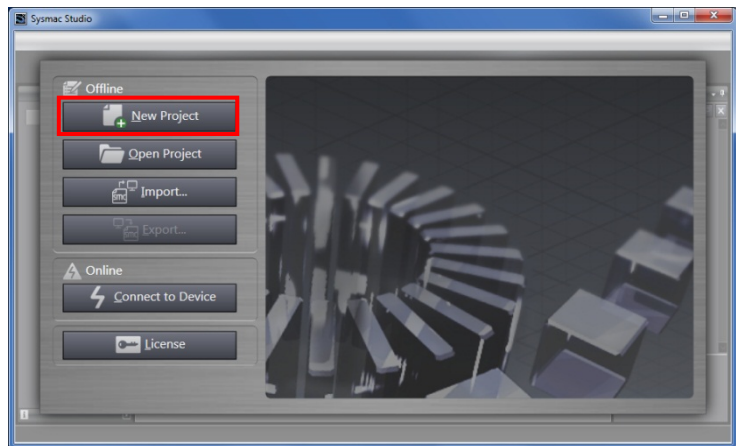

3 The Project Properties Dialog Box is displayed.

\*In this document, New Project is used as Project name.

Check that the device used is shown in the *Category* and the *Device* Fields of Select Device.

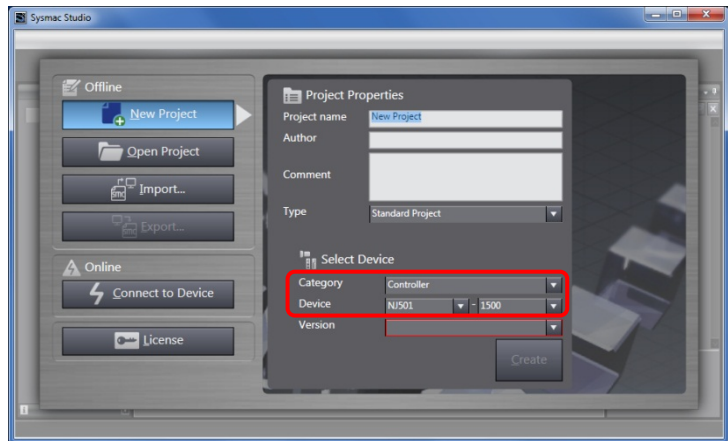

Select an applicable version from the pull-down list of Version.

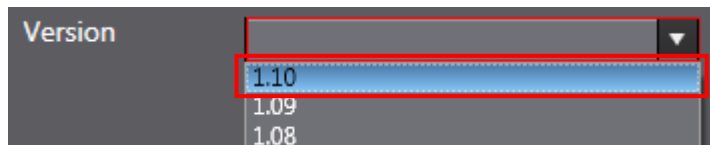

\*Although 1.10 is selected in this document for example, select the version you actually use.

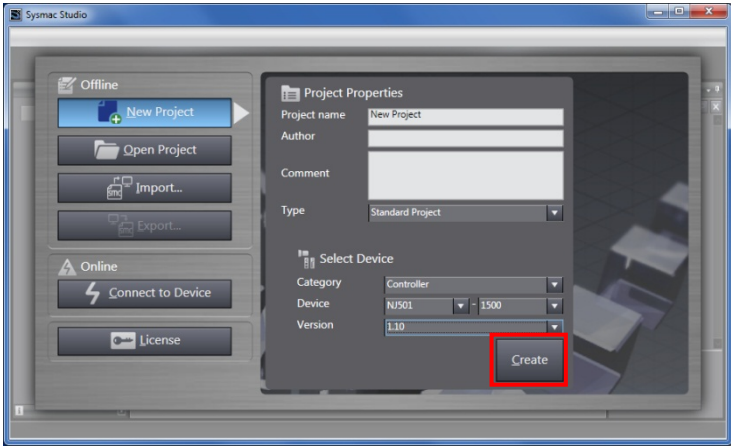
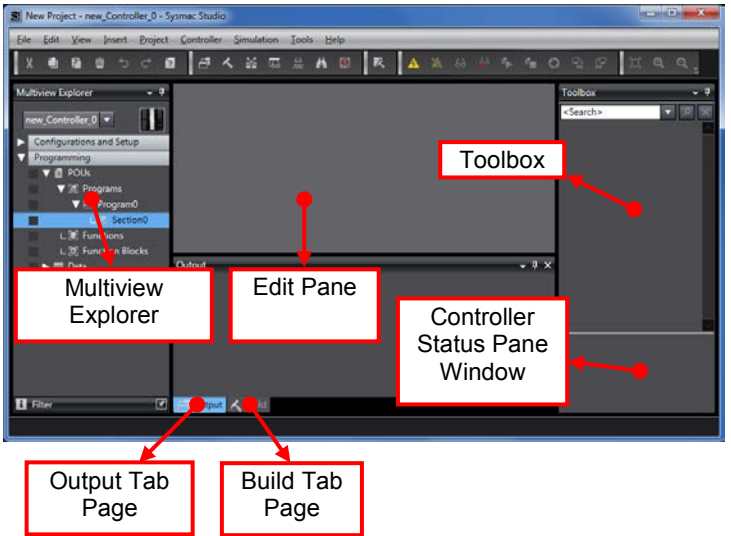
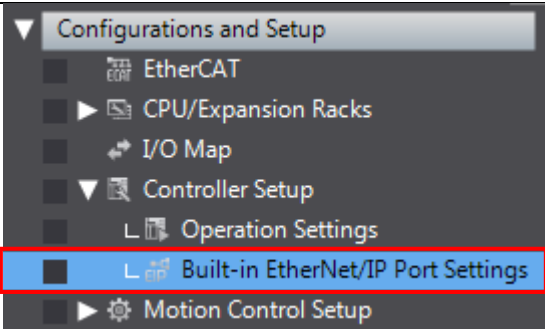
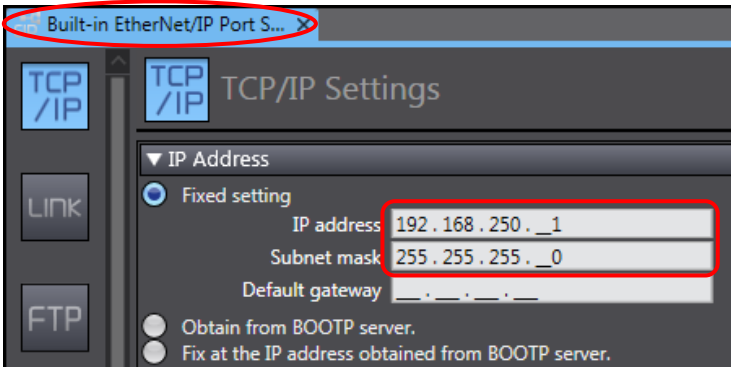
- 4** Click **Create**.
- 
- 5** The New Project is displayed.
- The following panes are displayed in this window.
- Left: Multiview Explorer
  - Top right: Toolbox
  - Bottom right: Controller Status Pane
  - Middle top: Edit Pane
- The following tab pages are displayed at the middle bottom of the window.
- Output Tab Page
  - Build Tab Page
- 
- 6** Double-click **Built-in EtherNet/IP Port Settings** under **Configurations and Setup - Controller Setup** in the Multiview Explorer.
- 
- 7** The Built-in EtherNet/IP Port Settings Tab Page is displayed in the Edit Pane.
- Check that the following settings are made in the *IP Address* Field.
- IP address: 192.168.250.1  
Subnet mask: 255.255.255.0
- 

7.3.2. Target Device Registration

Register the target device.

- 1 Select **EtherNet/IP Connection Settings** from the Tools Menu.

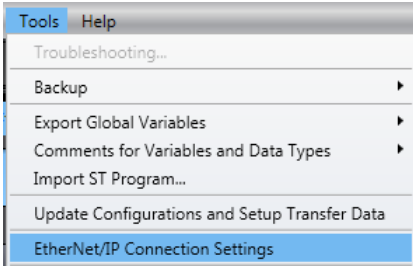
- 2 The EtherNet/IP Device List Tab Page is displayed in the Edit Pane. While the Built-in EtherNet/IP Port Settings is being selected, right-click and select **Edit** from the menu.

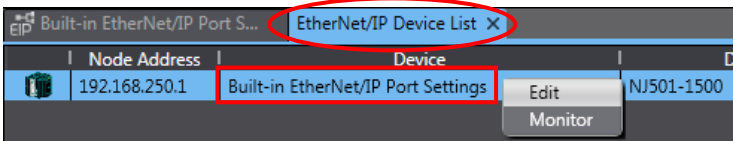
- 3 The Built-in EtherNet/IP Port Settings Connection Settings Tab Page is displayed in the Edit Pane.

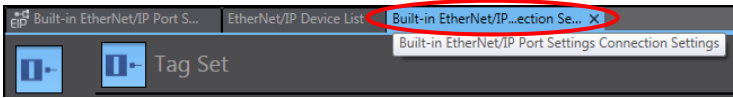

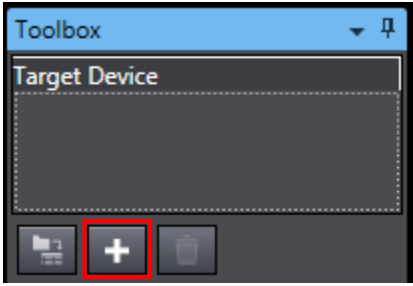
- 4 Click the + Button in Toolbox.

- 5 Data fields of the target device registration are displayed.

Enter *192.168.250.2* in the *Node address* Field.

Select the following values from the pull-down lists of Model name and Revision.

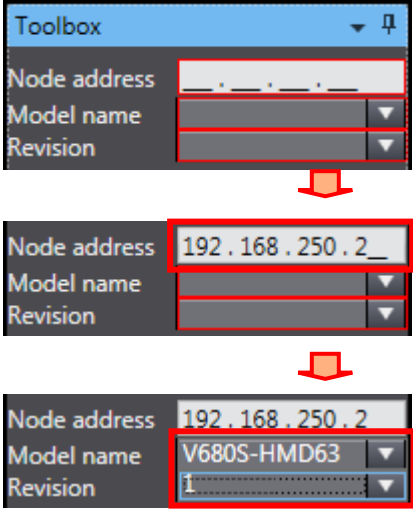
Model name: **V680S-HMD63**  
Revision: **1**



6 Check the settings and click **Add**.

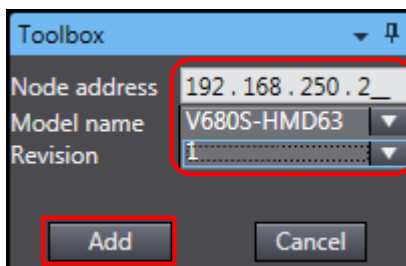

7 192.168.250.2 is registered in Target Device of Toolbox.

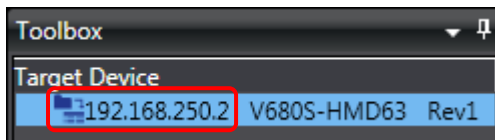

7.3.3. Setting the Global Variables

Set the global variables to use for the tag data links.

1 Double-click **Global Variables** under **Programming - Data** in the Multiview Explorer.

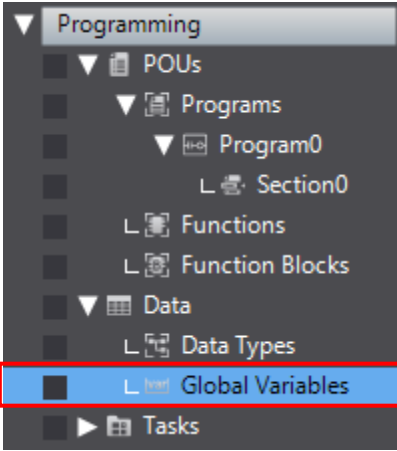

2 The Global Variables Tab Page is displayed in the Edit Pane.

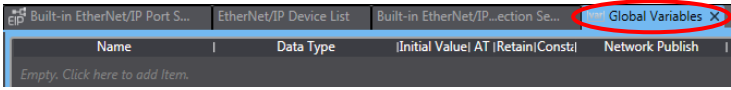

Click a column under the *Name* Column to enter a new variable.



Enter *EIP002\_Control\_OUT* in the *Name* Column.



Enter *BOOL[16]* in the *Data Type* Column.



After entering, check that the Data Type changes to *ARRAY[0..15] OF BOOL*.

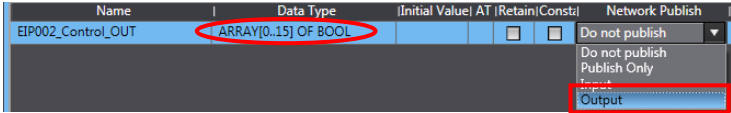

Select **Output** from the Network Publish Menu.

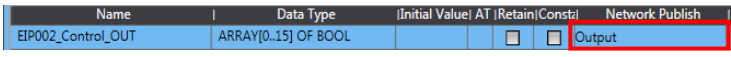

3 After entering, right-click and select **Create New** from the menu.

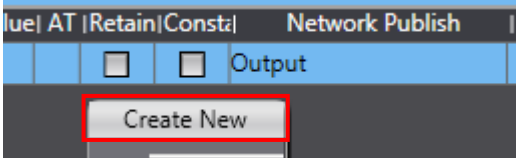



4 In the same way as steps 2 and 3, enter the following data in the new columns.

- Name:  
*EIP002\_CmdCode\_OUT*  
Data type: *WORD*  
Network Publish: *Output*
- Name:  
*EIP002\_CmdParam1\_OUT*  
Data Type: *WORD*  
Network Publish: *Output*
- Name:  
*EIP002\_CmdParam2\_OUT*  
Data Type: *WORD*  
Network Publish: *Output*
- Name:  
*EIP002\_CmdData\_OUT*  
Data Type: *WORD[16]*  
Network Publish: *Output*

Name	Data Type	Initial Value	AT	Retain/Const	Network Publish
EIP002_Control_OUT	ARRAY[0..15] OF BOOL			<input type="checkbox"/>	Output
EIP002_CmdCode_OUT	WORD			<input type="checkbox"/>	Output
EIP002_CmdParam1_OUT	WORD			<input type="checkbox"/>	Output
EIP002_CmdParam2_OUT	WORD			<input type="checkbox"/>	Output
EIP002_CmdData_OUT	ARRAY[0..15] OF WORD			<input type="checkbox"/>	Output

5 In the same way as steps 2 and 3, enter the following data in the new columns.

- Name: *EIP002\_Status\_IN*  
Data type: *BOOL[16]*  
Network Publish: *Input*
- Name: *EIP002\_ErrCode\_IN*  
Data Type: *WORD*  
Network Publish: *Input*
- Name: *EIP002\_RespInfo1\_IN*  
Data Type: *WORD*  
Network Publish: *Input*
- Name: *EIP002\_RespInfo2\_IN*  
Data Type: *WORD*  
Network Publish: *Input*
- Name: *EIP002\_RespData\_IN*  
Data Type: *WORD[16]*  
Network Publish: *Input*

Name	Data Type	Initial Value	AT	Retain/Const	Network Publish
EIP002_Control_OUT	ARRAY[0..15] OF BOOL			<input type="checkbox"/>	Output
EIP002_CmdCode_OUT	WORD			<input type="checkbox"/>	Output
EIP002_CmdParam1_OUT	WORD			<input type="checkbox"/>	Output
EIP002_CmdParam2_OUT	WORD			<input type="checkbox"/>	Output
EIP002_CmdData_OUT	ARRAY[0..15] OF WORD			<input type="checkbox"/>	Output
EIP002_Status_IN	ARRAY[0..15] OF BOOL			<input type="checkbox"/>	Input
EIP002_ErrCode_IN	WORD			<input type="checkbox"/>	Input
EIP002_RespInfo1_IN	WORD			<input type="checkbox"/>	Input
EIP002_RespInfo2_IN	WORD			<input type="checkbox"/>	Input
EIP002_RespData_IN	ARRAY[0..15] OF WORD			<input type="checkbox"/>	Input

6 Double-click **Task Settings** under **Configurations and Setup** in the Multiview Explorer. The Task Settings Tab Page is displayed in the Edit Pane. Click **VAR**.

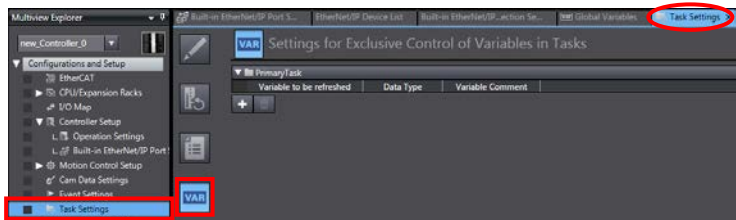

7 Click the + Button.

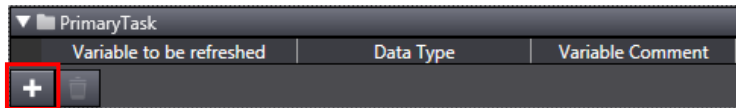

A new column is added.  
Click the **Down Arrow** Button of the *Variable to be refreshed* Field (on the left side).

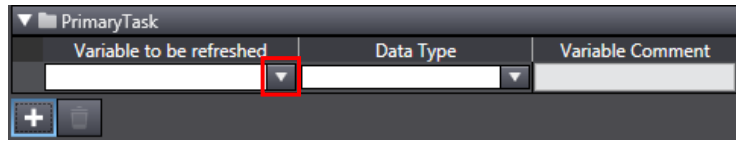

The variables set in this sub-clause are displayed.  
Select **EIP002\_Data\_OUT**.

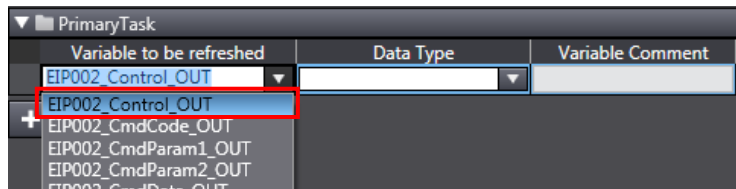

EIP002\_Control\_OUT is added.

\*The data types are displayed automatically, so no need to be set.

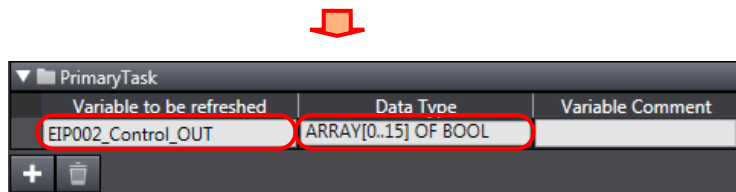

8 In the same way as step 7, add the all variables set in this sub-clause in the *Variable to be refreshed* Field (on the left side).

\*The data types are displayed automatically, so no need to be set.

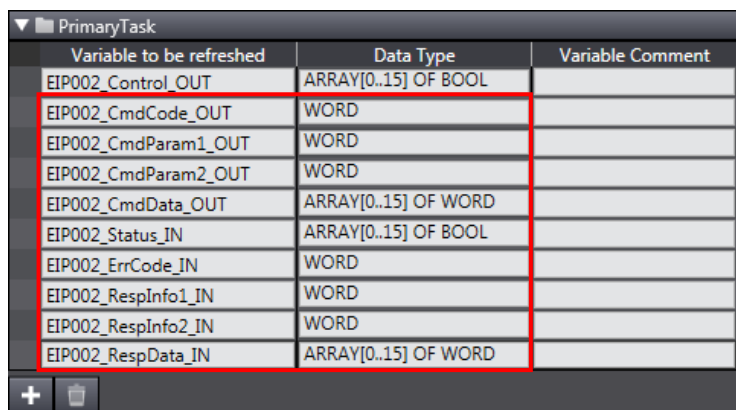

### 7.3.4. Tag Registration

Register the tags and the tag sets.

<p>1 Click the <b>Tag Set</b> Button in the Built-in EtherNet/IP Port Settings Connection Settings Tab Page. Select the <b>Input</b> Tab in Tag Sets.</p>	
<p>2 Right-click any open space in the Input Tab Page and select <b>Create New Tag Set</b> from the menu.</p>	
<p>3 A new name in the <i>Tag Set Name</i> Column can be entered. Select the column newly added.  Enter <i>EIP002_IN</i>.</p>	
<p>4 While the EIP002_IN is being selected, right-click and select <b>Create New Tag</b> from the menu.  A new tag name can be entered in the EIP002_IN. Select the column newly added.  Set the global variable of IN No.1 listed in 6.3. <i>Tag Sets</i> as a tag.  *When the first character of the set variable is entered, the list that starts with the character entered is displayed.</p>	

- 5 In the same way as step 4, set the other global variable as tags in order of IN No. listed in 6.3. *Tag Sets*.
- | Tag Set Name        | Bit Selection                       | Size (Byte) | Size (Bit) |
|---------------------|-------------------------------------|-------------|------------|
| EIP002_IN           | <input type="checkbox"/>            | 40          |            |
| EIP002_Status_IN    | <input checked="" type="checkbox"/> | 2           | 16         |
| EIP002_ErrCode_IN   | <input type="checkbox"/>            | 2           | 0          |
| EIP002_RespInfo1_IN | <input type="checkbox"/>            | 2           | 0          |
| EIP002_RespInfo2_IN | <input type="checkbox"/>            | 2           | 0          |
| EIP002_RespData_IN  | <input type="checkbox"/>            | 32          | 0          |
- 6 Select **Output** Tab. Right-click any open space in the Output Tab Page and select **Create New Tag Set** from the menu.
- 7 A new name in the *Tag Set Name* Column can be entered. In the same way as step 3, enter *EIP002\_OUT*.
- | Tag Set Name | Bit Selection            | Size (Byte) | Size (Bit) |
|--------------|--------------------------|-------------|------------|
| EIP002_OUT   | <input type="checkbox"/> | 0           |            |
- 8 In the same way as step 4, set the global variables as tags, and make sure that the tag list shows the variables in order of OUT No. listed in 6.3. *Tag Sets*.
- | Tag Set Name         | Bit Selection                       | Size (Byte) | Size (Bit) |
|----------------------|-------------------------------------|-------------|------------|
| EIP002_OUT           | <input type="checkbox"/>            | 40          |            |
| EIP002_Control_OUT   | <input checked="" type="checkbox"/> | 2           | 16         |
| EIP002_CmdCode_OUT   | <input type="checkbox"/>            | 2           | 0          |
| EIP002_CmdParam1_OUT | <input type="checkbox"/>            | 2           | 0          |
| EIP002_CmdParam2_OUT | <input type="checkbox"/>            | 2           | 0          |
| EIP002_CmdData_OUT   | <input type="checkbox"/>            | 32          | 0          |
- 9 Check that Tag Sets shows 2 and that the value of Tags shows the same as the number of the global variables set.
- Tag Sets  
Tag Sets/Max: 2 / 32    Tags/Max: 10 / 256

7.3.5. Setting the Connections

Set the target variable (that receives the open request) and the originator variable (that requests opening), and then set the connections (tag data link table).

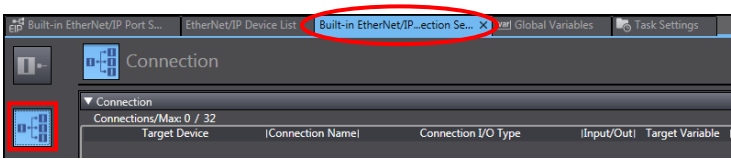
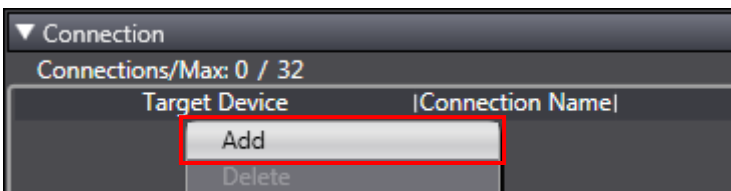
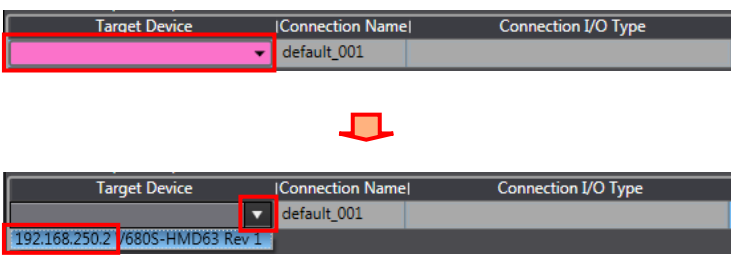
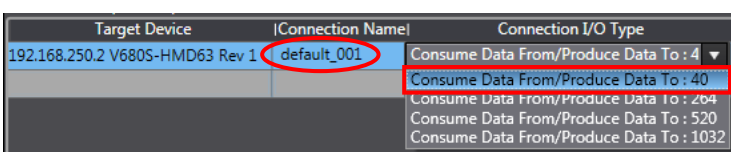
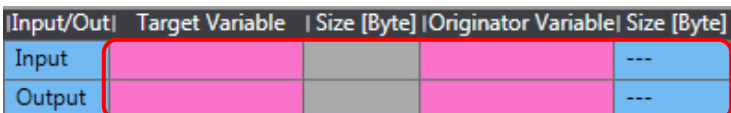
<p>1 Click the <b>Connection</b> Button in the Built-in EtherNet/IP Port Settings Connection Settings Tab Page.</p>	
<p>2 Right-click any open space in Connection and select <b>Add</b> from the menu.</p>	
<p>3 A new connection can be entered. Select the column newly added.</p> <p>Select <b>192.168.250.2</b> from the pull-down list under the <i>Target Device</i> Column.</p>	
<p>4 The default_001 is created in the <i>Connection Name</i> Column. Select <b>Consume Data From/Produce Data To: 40</b> from the Connection I/O Type pull-down list.</p>	
<p>5 The target variable and the originator variable can be set.</p>	

6 Click a column in Target Variable of Input.

When you press **Ctrl + Space** Keys on the keyboard, an applicable instance number appears.

\*The instance number also appears even when the first character of the instance number "1" is entered.

Select the instance number.

In the same way, set Target Variable of Output.

Input/Out	Target Variable	Size [Byte]	Originator Variable	Size [Byte]
Input				---
Output				---

↓

Input/Out	Target Variable	Size [Byte]	Originator Variable	Size [Byte]
Input				---
Output	110 111 112 113			---

↓

Input/Out	Target Variable	Size [Byte]	Originator Variable	Size [Byte]
Input	110	40		---
Output				---

↓

Input/Out	Target Variable	Size [Byte]	Originator Variable	Size [Byte]
Input	110	40		---
Output	100			---

7 Click a column in Originator Variable of Input.

The pull-down list is displayed.

Select the tag set name to use.

In the same way, set Originator Variable of Output.

Input/Out	Target Variable	Size [Byte]	Originator Variable	Size [Byte]
Input	110	40		---
Output	100	40	EIP002_IN	---

↓

Input/Out	Target Variable	Size [Byte]	Originator Variable	Size [Byte]
Input	110	40	EIP002_IN	40
Output	100	40	EIP002_OUT	40

8 Set Connection Type, RPI [ms], and Timeout Value as required.

\*In this document, the default values are used for these settings.

Originator Variable	Size [Byte]	Connection Type	RPI [ms]	Timeout Value
EIP002_IN	40	Point to Point connection	50.0	RPI x 4
EIP002_OUT	40	Point to Point connection		

9 Check that Connections shows 1.

▼ Connection
Connections/Max: 1 / 32

7.3.6. Transferring the Project Data

Connect online and transfer the connection settings and the project data to Controller.

**WARNING**

When you transfer a user program, configuration data, setup data, device variables, or values in memory used for CJ-series Units from Sysmac Studio, the devices or machines may perform unexpected operation regardless of the operating mode of CPU Unit.

Always confirm safety at the destination node before you transfer the project data.

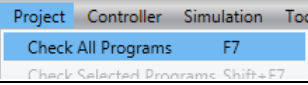
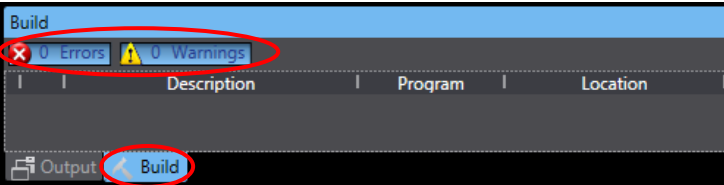
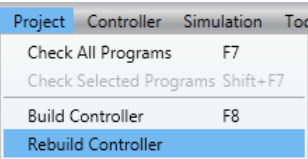
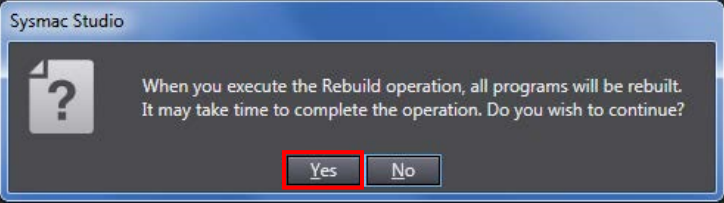
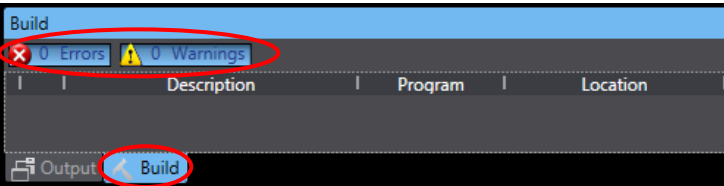
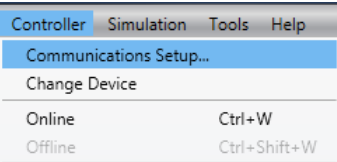
1	Turn ON the power supply to Controller.	
2	Select <b>Check All Programs</b> from the Project Menu.	
3	The Build Tab Page is displayed. Check that "0 Errors" and "0 Warnings" are displayed.	
4	Select <b>Rebuild Controller</b> from the Project Menu.	
5	A confirmation dialog box is displayed. Check the contents and click <b>Yes</b> .	
6	Check that "0 Errors" and "0 Warnings" are displayed in the Build Tab Page.	
7	Select <b>Communications Setup</b> from the Controller Menu.	

- 8 The Communications Setup Dialog Box is displayed. Check that *Direct connection via USB* is selected for Connection type. Click **OK**.

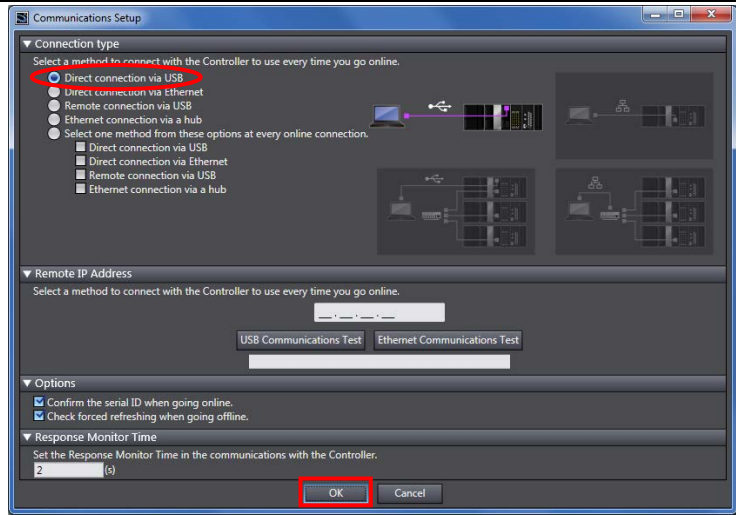

- 9 Select **Online** from the Controller Menu. If a confirmation dialog box is displayed, check the contents and click **Yes**.

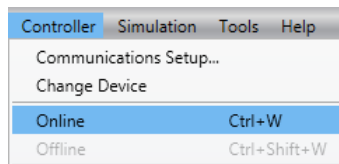

\*The displayed dialog depends on the status of Controller used. Check the contents and click **OK** or **Yes** to proceed with the processing.

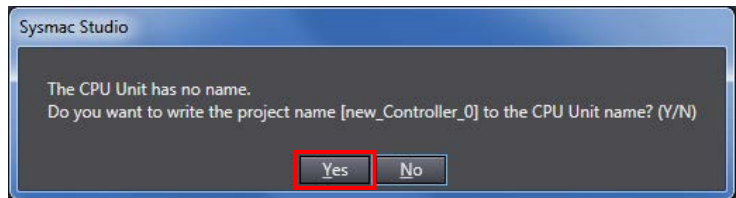

- 10 When an online connection is established, a yellow bar is displayed on the top of the Edit Pane.

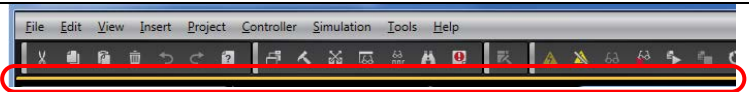

**Additional Information**

For details on online connections to Controller, refer to *Section 6. Online Connections to a Controller* of the *Sysmac Studio Version 1 Operation Manual (Cat. No. W504)*.

- 11 Select **Synchronization** from the Controller Menu.

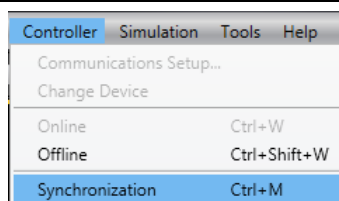



12 The Synchronization Dialog Box is displayed.

Check that the data to transfer (NJ501 in the right dialog box) is selected.

Uncheck *Do not transfer the EtherNet/IP connection settings (built-in port and Unit)*.

Click **Transfer To Controller**.

\*After executing Transfer To Controller, the Sysmac Studio data is transferred to Controller and the data is compared.

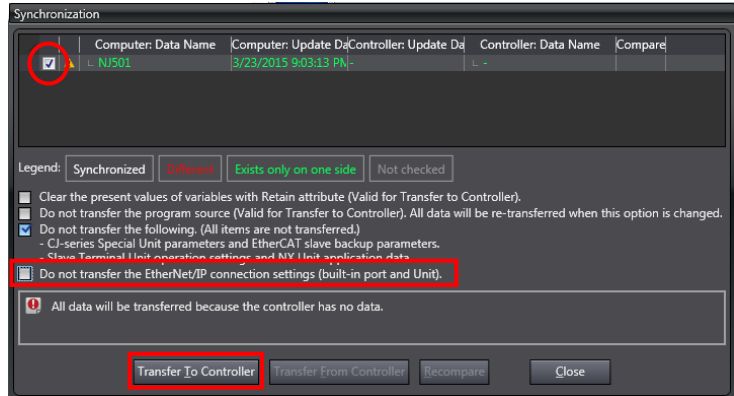

13 A confirmation dialog box on the right is displayed. Check that there is no problem, and click **Yes**.

A screen stating "Synchronizing" is displayed.

A confirmation dialog box on the right is displayed. Check that there is no problem, and click **No**.

\*Do not return to RUN mode.

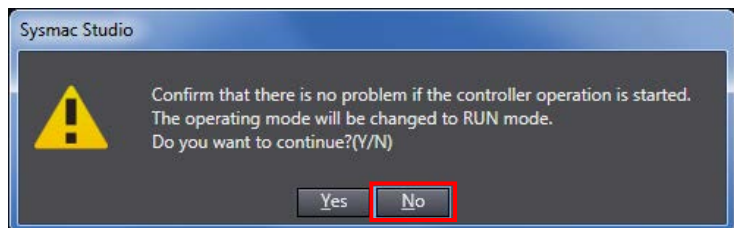
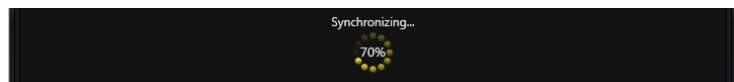
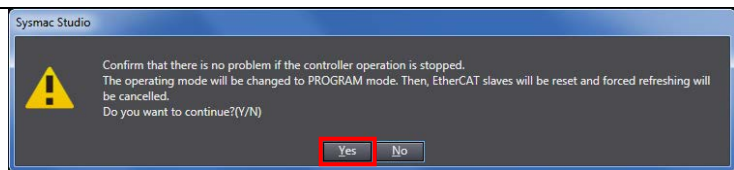

- 14 Check that the synchronized data is displayed with the color specified by "Synchronized", and that a message is displayed stating "The synchronization process successfully finished". If there is no problem, click **Close**.

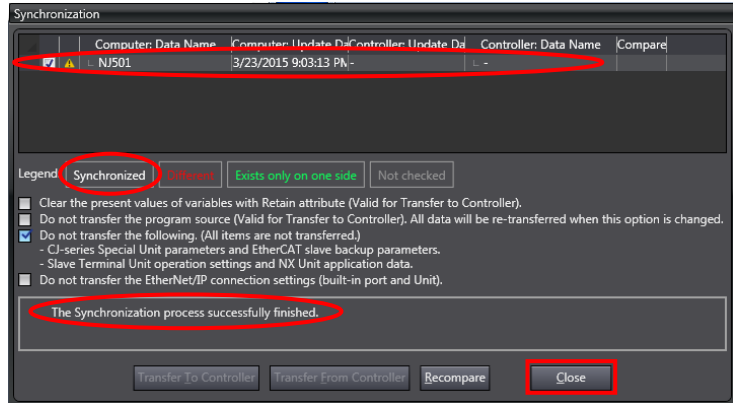

\*A message stating "The synchronization process successfully finished" is displayed if the Sysmac Studio project data coincides with the Controller data.

\*If the synchronization fails, check the wiring and repeat from step 1.

- 15 Check that ERR/ALM indicator in the Controller Status Pane changes to green color and that PROGRAM mode is displayed.

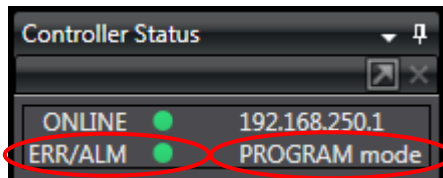

**Precautions for Correct Use**

If you change the connection settings (tag data link table) after performing the synchronization, the connection settings (tag data link table) are not transferred even when performing the synchronization again.

When transferring, click **Transfer to Controller** in the Built-in EtherNet/IP Port Settings Connection Settings Tab Page to transfer.

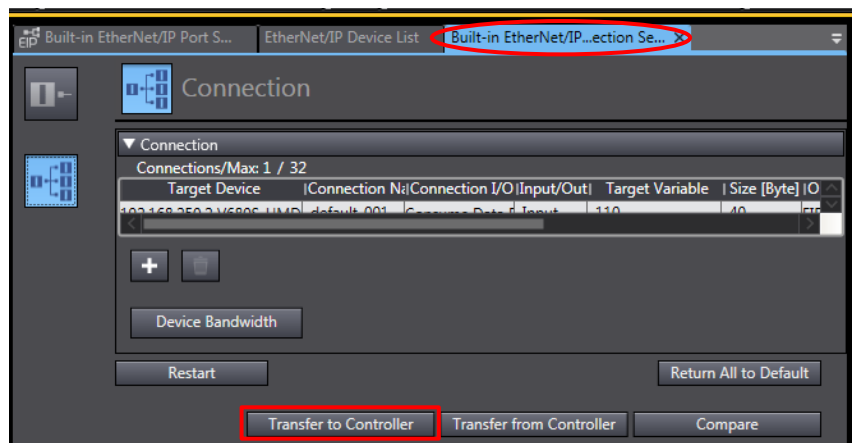

**7.4. Checking the EtherNet/IP Communications**

Check that EtherNet/IP tag data links are operated normally.

**7.4.1. Checking the Connection Status**

Check the connection status of EtherNet/IP.

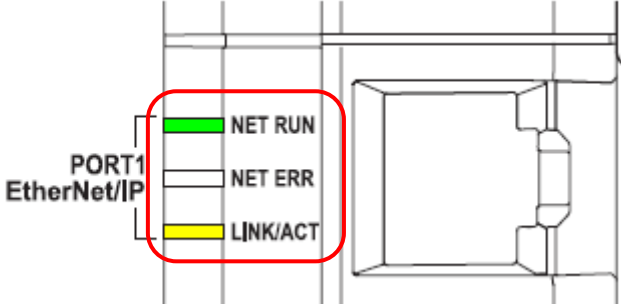
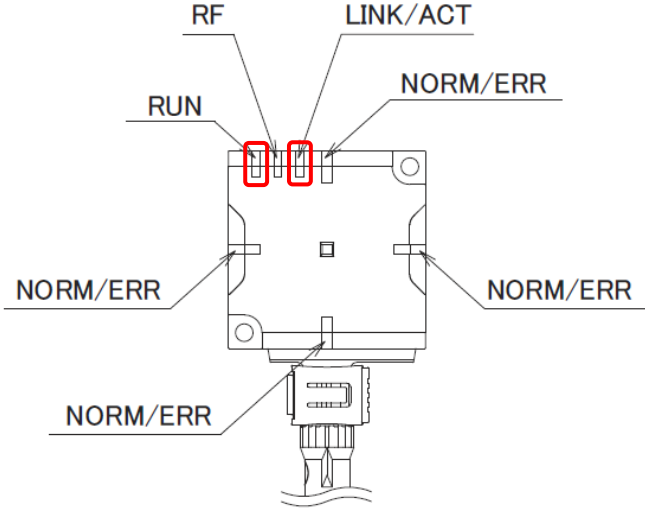
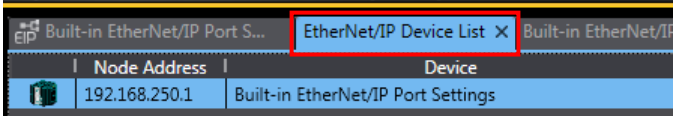
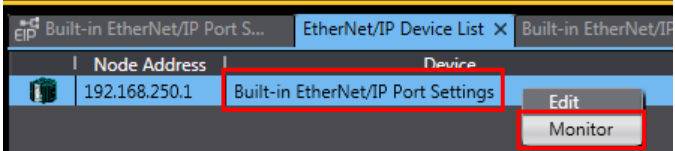
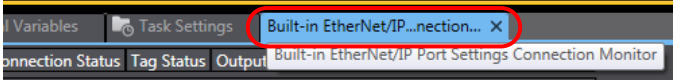
<p>1</p>	<p>Check with LED indicators of Controller that the tag data links are performed normally.</p> <p>LED indicators in normal status are as follows:          NET RUN: Green lit          NET ERR: Not lit          LINK/ACT: Yellow flashing          (Flashing while packets are being sent and received)</p>	
<p>2</p>	<p>Check LED indicators of RFID Reader/Writer.</p> <p>The LED indicators in normal status are as follows:          RUN: Green lit          LINK/ACT : Green lit          (Flashing while packets are being sent and received)</p>	
<p>3</p>	<p>Select the <b>EtherNet/IP Device List</b> Tab.</p>	
<p>4</p>	<p>While the Built-in EtherNet/IP Port Settings is being selected, right-click and select <b>Monitor</b> from the menu.</p>	
<p>5</p>	<p>The Built-in EtherNet/IP Port Settings Connection Monitor Tab Page is displayed.</p>	

- 6 Select the **Status** Tab.  
When the same check boxes are selected as shown on the right, the tag data links are normally in operation.

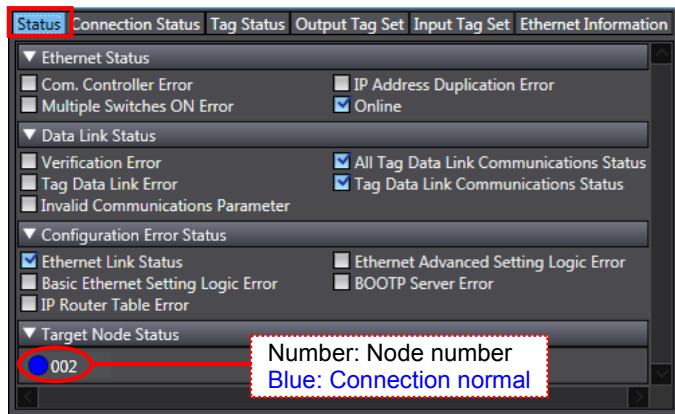

- 7 Select the **Connection Status** Tab.  
Check that a blue circle is displayed next to the applicable connection listed in the *Connection Name* Column.  
Check that the Status is 00:0000.

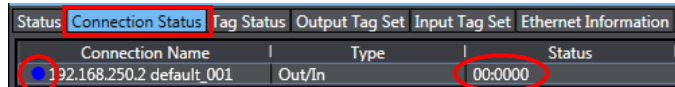

- 8 Select the **Tag Status** Tab.  
Check that all tags in the *Tag Name* Column are displayed and that green circles are displayed next to them. Check that the statuses for all tags are normally resolved.

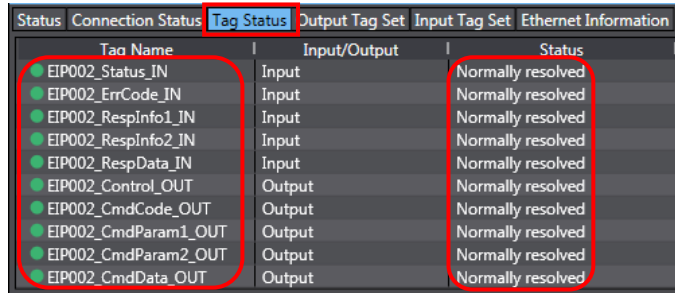

7.4.2. Checking the Sent and Received Data

Check that the correct data are sent and received.

In this document, sent and received data are checked in the following steps by executing READ DATA and WRITE DATA commands for RF Tag address 0000 hex..

No.	Description	Command	Step No. in the procedure
1	Reading data from an RF Tag.	READ DATA	Steps 5 to 9
2	Writing data to the memory of the RF Tag.	WRITE DATA	Steps 10 to 12
3	Checking a result of the write data No.2.	READ DATA	Steps 13 to 15

**Caution**

If you change the values of variables on a Watch Tab Page in the online state, the connected devices to the output unit may operate regardless of the operating mode of CPU Unit.

Sufficiently confirm safety before you change the values of variables on a Watch Tab Page when Sysmac Studio is online with CPU Unit.



**Additional Information**

For details on commands available in RFID Reader/Writer, refer to *V680S Command Details* in *Section 5. Host Communications Specifications of the V680S Series User's Manual (EtherNet/IP™) Reader/Writer* (Cat. No. Z535).

1	<p>Select <b>Watch Tab Page</b> from the View Menu.</p>	
2	<p>Select the <b>Watch1</b> Tab.</p>	
3	<p>Click <i>Input Name</i>, and enter the following names of the variables.</p> <p><i>EIP002_Control_OUT[0]</i>  <i>EIP002_CmdCode_OUT</i>  <i>EIP002_CmdParam1_OUT</i>  <i>EIP002_CmdParam2_OUT</i>  <i>EIP002_CmdData_OUT[0]</i>  <i>EIP002_RespData_IN[0]</i></p>	<ul style="list-style-type: none"> <li><span style="color: red;">*</span> To execute a command by changing FALSE to TRUE</li> <li><span style="color: red;">*</span> To enter a command code</li> <li><span style="color: red;">*</span> To enter the first address for command execution</li> <li><span style="color: red;">*</span> To enter the number of WORDs for command execution</li> <li><span style="color: red;">*</span> To enter a command data</li> <li><span style="color: red;">*</span> To output response data</li> </ul>

4 Place RF Tag over the antenna (data reading part) of RFID Reader/Writer as shown on the right.

\*The distance between RFID Reader/Writer and RF Tag differs depending on the type of RF Tag used and the installation environment of RFID Reader/Writer. For details, refer to *Communications Range Specifications* in *Data Characteristics* in *Section 8. Appendices of the V680S Series User's Manual (EtherNet/IP™) Reader/Writer (Cat. No. Z353)*.

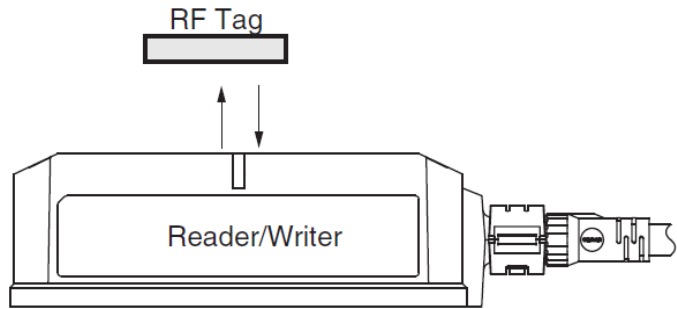

5 In steps 5 to 9, read the data from RF Tag address 0000 hex.

Check that the online value of *EIP002\_Control\_OUT[0]* is False.

\*If the online value of *EIP002\_Control\_OUT[0]* is True, click **FALSE** in the *Modify* Column to change the online value to False.

Name	Online value	Modify
EIP002_Control_OUT[0]	False	TRUE FALSE
EIP002_CmdCode_OUT	0000	
EIP002_CmdParam1_OUT	0000	
EIP002_CmdParam2_OUT	0000	
EIP002_CmdData_OUT[0]	0000	
EIP002_RespData_IN[0]	0000	

6 Enter 0002 (READ DATA command) in the *Modify* Column of *EIP002\_CmdCode\_OUT*.

By pressing the **Enter** Key, the online value of *EIP002\_CmdCode\_OUT* changes to 0002.

Name	Online value	Modify
EIP002_Control_OUT[0]	False	TRUE FALSE
EIP002_CmdCode_OUT	0000	0002
EIP002_CmdParam1_OUT	0000	
EIP002_CmdParam2_OUT	0000	
EIP002_CmdData_OUT[0]	0000	
EIP002_RespData_IN[0]	0000	



Name	Online value	Modify
EIP002_Control_OUT[0]	False	TRUE FALSE
EIP002_CmdCode_OUT	0002	0002
EIP002_CmdParam1_OUT	0000	
EIP002_CmdParam2_OUT	0000	
EIP002_CmdData_OUT[0]	0000	
EIP002_RespData_IN[0]	0000	

7 In the same way as step 6, enter 0000 (first address to read) to *EIP002\_CmdParam1\_OUT* and 0001 (number of WORDs to read) to *EIP002\_CmdParam2\_OUT*.

Name	Online value	Modify
EIP002_Control_OUT[0]	False	TRUE FALSE
EIP002_CmdCode_OUT	0002	0002
EIP002_CmdParam1_OUT	0000	0000
EIP002_CmdParam2_OUT	0001	0001
EIP002_CmdData_OUT[0]	0000	
EIP002_RespData_IN[0]	0000	

8 Click **TRUE** in the *Modify* Column of *EIP002\_Control\_OUT[0]*.  
The online value of *EIP002\_Control\_OUT[0]* changes to True, and READ DATA command is executed.  
  
The value of RF Tag address 0000 hex is read to the online value of *EIP002\_RespData\_IN[0]*.  
  
\*In this document, the value of RF Tag address 0000 hex is 1234. However, it differs depending on RF Tag used.

Name	Online value	Modify
EIP002_Control_OUT[0]	True	TRUE FALSE
EIP002_CmdCode_OUT	0002	0002
EIP002_CmdParam1_OUT	0000	0000
EIP002_CmdParam2_OUT	0001	0001
EIP002_CmdData_OUT[0]	0000	
EIP002_RespData_IN[0]	1234	

9 Click **FALSE** in the *Modify* Column of *EIP002\_Control\_OUT[0]* to change the online value to False.

Name	Online value	Modify
EIP002_Control_OUT[0]	False	TRUE FALSE
EIP002_CmdCode_OUT	0002	0002
EIP002_CmdParam1_OUT	0000	0000
EIP002_CmdParam2_OUT	0001	0001
EIP002_CmdData_OUT[0]	0000	
EIP002_RespData_IN[0]	1234	

10 In steps 10 to 12, write the read data to RF Tag memory address 0000 hex.  
  
\*In this document, 5678 is written.  
  
In the same way as step 6, enter 0003 (WRITE DATA command) to *EIP002\_CmdCode\_OUT*, 0000 (first address to write) to *EIP002\_CmdParam2\_OUT*, 0001 (number of WORDs to write) to *EIP002\_CmdData\_OUT[0]*, and 5678 (write data) to *EIP002\_CmdData\_OUT[0]*.

Name	Online value	Modify
EIP002_Control_OUT[0]	False	TRUE FALSE
EIP002_CmdCode_OUT	0003	0003
EIP002_CmdParam1_OUT	0000	0000
EIP002_CmdParam2_OUT	0001	0001
EIP002_CmdData_OUT[0]	5678	5678
EIP002_RespData_IN[0]	1234	

11 Click **TRUE** in the *Modify* Column of *EIP002\_Control\_OUT[0]*.  
The online value of *EIP002\_Control\_OUT[0]* changes to True, and WRITE DATA command is executed.

Name	Online value	Modify
EIP002_Control_OUT[0]	True	TRUE FALSE
EIP002_CmdCode_OUT	0003	0003
EIP002_CmdParam1_OUT	0000	0000
EIP002_CmdParam2_OUT	0001	0001
EIP002_CmdData_OUT[0]	5678	5678
EIP002_RespData_IN[0]	1234	

\**EIP002\_RespData\_IN* is not used for WRITE DATA command.

12 Click **FALSE** in the *Modify* Column of *EIP002\_Control\_OUT[0]* to change the online value to False.

Name	Online value	Modify
EIP002_Control_OUT[0]	False	TRUE FALSE
EIP002_CmdCode_OUT	0003	0003
EIP002_CmdParam1_OUT	0000	0000
EIP002_CmdParam2_OUT	0001	0001
EIP002_CmdData_OUT[0]	5678	5678
EIP002_RespData_IN[0]	1234	

13 In steps 13 to 15, check that the correct data were written to RF Tag memory address 0000 hex.

In the same way as step 6, enter 0002 (READ DATA command) to *EIP002\_CmdCode\_OUT*, 0000 (first address to read) to *EIP002\_CmdParam1\_OUT*, and 0001 (number of WORDs to write) to *EIP002\_CmdParam2\_OUT*.

Name	Online value	Modify
EIP002_Control_OUT[0]	False	TRUE FALSE
EIP002_CmdCode_OUT	0002	0002
EIP002_CmdParam1_OUT	0000	0000
EIP002_CmdParam2_OUT	0001	0001
EIP002_CmdData_OUT[0]	5678	5678
EIP002_RespData_IN[0]	1234	

\**EIP002\_CmdData\_OUT* is not used for READ DATA command.



- 14 Click **TRUE** in the *Modify* Column of *EIP002\_Control\_OUT[0]*.  
The online value of *EIP002\_Control\_OUT[0]* changes to True, and READ DATA command is executed.

Name	Online value	Modify
EIP002_Control_OUT[0]	True	TRUE FALSE
EIP002_CmdCode_OUT	0002	0002
EIP002_CmdParam1_OUT	0000	0000
EIP002_CmdParam2_OUT	0001	0001
EIP002_CmdData_OUT[0]	5678	5678
EIP002_RespData_IN[0]	5678	

The data that were written in steps 10 to 12 are read to the online value of *EIP002\_RespData\_IN[0]*.

\*In this document, the online value of *EIP002\_RespData\_IN[0]* changes to 5678. This means that the correct data are written.

- 15 Click **FALSE** in the *Modify* Column of *EIP002\_Control\_OUT[0]* to change the online value to False.

Name	Online value	Modify
EIP002_Control_OUT[0]	False	TRUE FALSE
EIP002_CmdCode_OUT	0002	0002
EIP002_CmdParam1_OUT	0000	0000
EIP002_CmdParam2_OUT	0001	0001
EIP002_CmdData_OUT[0]	5678	5678
EIP002_RespData_IN[0]	5678	

## 8. Initialization Method

This document provides the explanation of the setting procedure based on the factory default setting.

Some settings may not be applicable as described in this document unless you use the devices with the factory default setting.

### 8.1. Initializing Controller

To initialize the settings of Controller, it is necessary to initialize CPU Unit.

Change Controller to PROGRAM mode before the initialization. Select **Clear All Memory** from the Controller Menu of Sysmac Studio. The Clear All Memory Dialog Box is displayed. Check the contents and click **OK**.

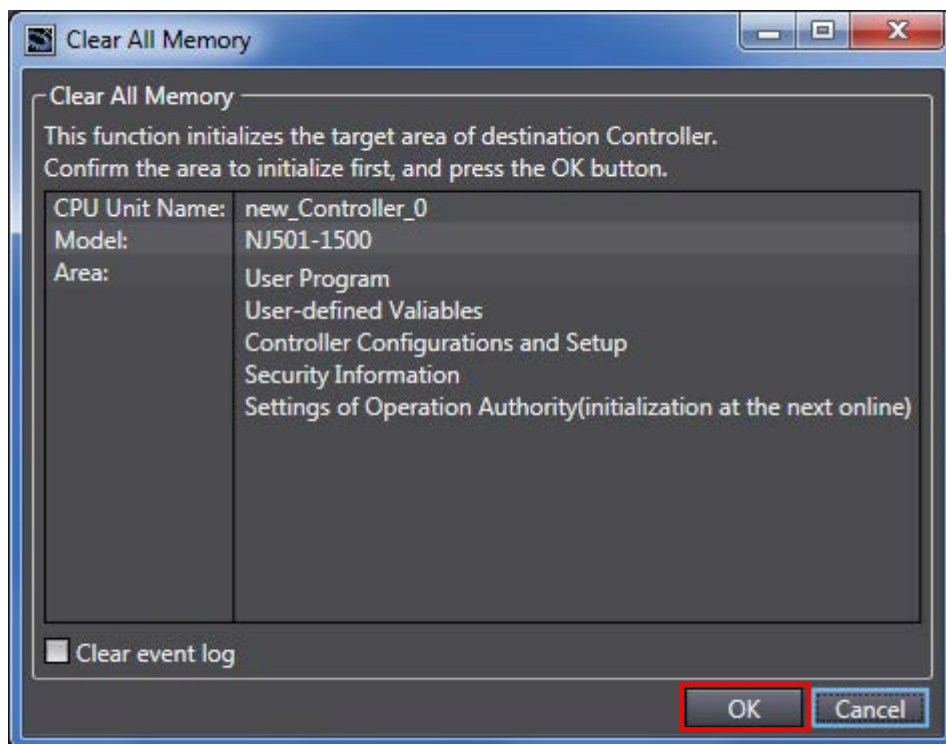

### 8.2. Initializing RFID Reader/Writer

For the initialization of RFID Reader/Writer, refer to *Initializing the Settings in Configuration in Operation Interface* in *Section 6. Browser Interface of the V680S Series User's Manual (EtherNet/IP™) Reader/Writer (Cat. No. Z353)*.

## 9. Appendix 1 Procedure Using the Project File

This section describes the procedure in which you use the following project file. The project file includes the contents that are set in 7.3. *Setting up Controller*. Obtain the latest project file from OMRON.

Name	File name	Version
Sysmac Studio compact project file (Extension: csm2)	OMRON_V680S_EIP_V100.csm2	Ver.1.00

### 9.1. Work Flow

Take the following steps to make the tag data link settings for EtherNet/IP using the project file.

Except 9.2.1. *Importing the Project File* enclosed in red, refer to each appropriate clause and sub-clause for further information.

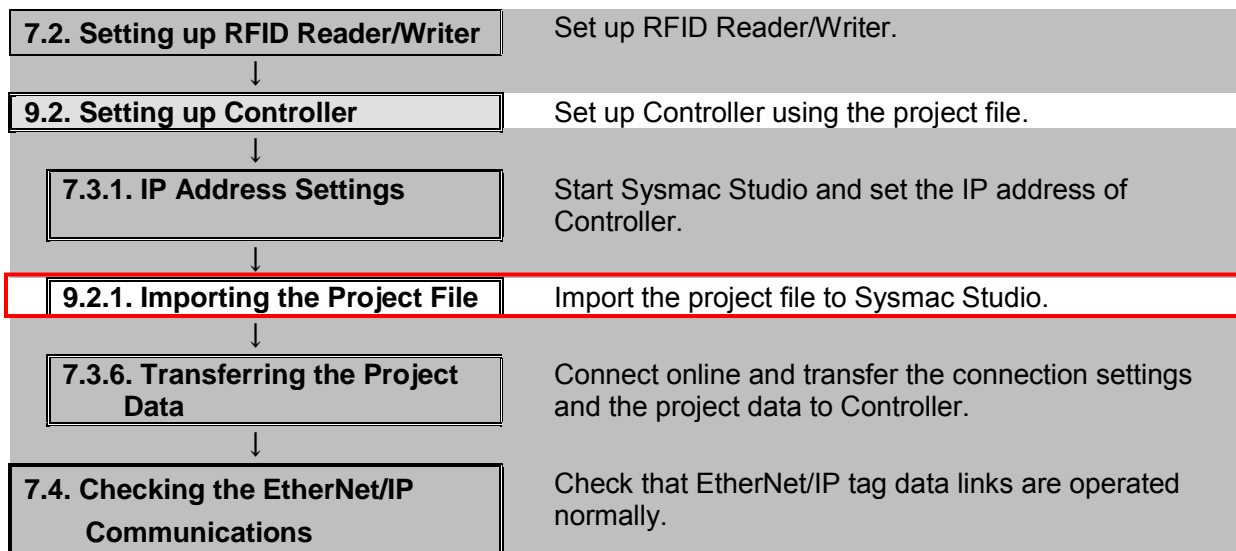

## 9.2. Setting up Controller

Set up Controller using the project file.

### 9.2.1. Importing the Project File

Import the project file to Sysmac Studio.

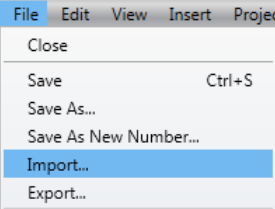
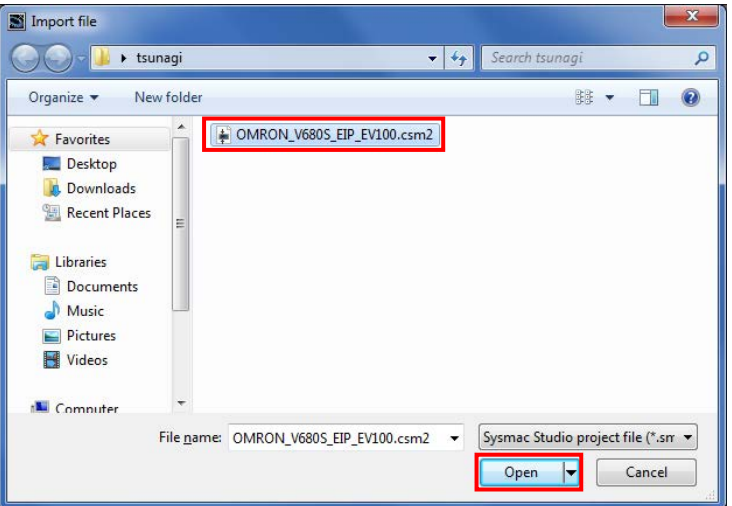
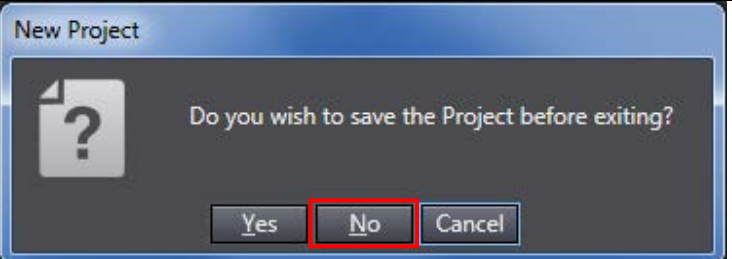
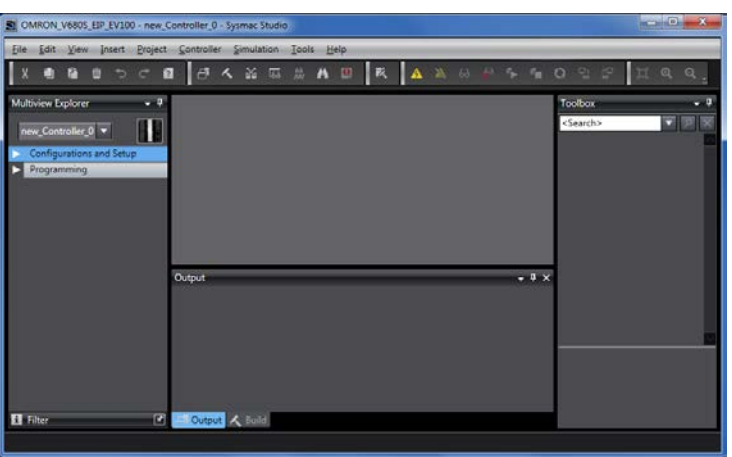
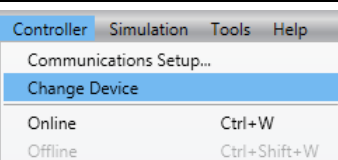
<p>1 Select <b>Import</b> from the File Menu.</p>	
<p>2 The Import file Dialog Box is displayed. Select <b>OMRON_V680S_EIP_EV100.csm2</b> (project file) and click <b>Open</b>.  *Obtain the project file from OMRON.</p>	
<p>3 The New Project Dialog Box is displayed. Check the contents and click <b>No</b>.</p>	
<p>4 The <b>OMRON_V680S_EIP_EV100</b> project is displayed.  *If an error message is displayed stating "Failed to Load Descendants", change the version of Sysmac Studio to the version specified in 5.2. <i>Device Configuration</i> or higher version.</p>	
<p>5 Select <b>Change Device</b> from the Controller Menu.</p>	

- 6 The Change Device Dialog Box is displayed.  
Check that the *Device* and the *Version* Fields are set as shown on the right.

Click **Cancel**.

\*If the settings are different, select the setting items from the pull-down list and click **OK**.

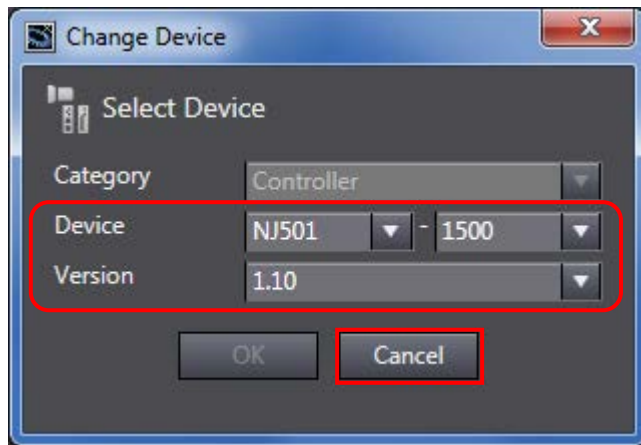

- 7 If you changed the settings in step 6, the Build Dialog Box is displayed. Check the contents and click **Yes**.

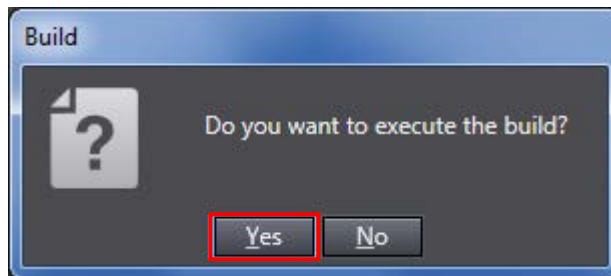

## 10. Appendix 2 Setting the Tag Data Links

This section explains the settings for the change of data size to use for the tag data links. You can choose the data size from the following four sizes.

Data Size	Data size that can be read or written for an RF Tag in one operation (Maximum)
40 bytes	32 bytes
264 bytes	256 bytes
520 bytes	512 bytes
1032 bytes*	1024 bytes

\*600 bytes is the maximum data size to perform the tag data links by using the Built-in EtherNet/IP port on NJ-series CPU Unit, which means that you can use the data size up to 520 bytes. For 1032 bytes, you can use it by installing CJ-series EtherNet/IP Unit.

### 10.1. Global Variables

The settings of the global variables are the following.

Set the data type of the global variables marked with red squares to "Data size that can be read or written for an RF Tag in one operation".

For settings, refer to 7.3.3. *Setting the Global Variables*.

Name	Data Type	Network Publish	Destination Device Allocation	Data Size (Byte)
EIP002_Control_OUT	BOOL[16]	Output	Command Area (Array of bit)	2
EIP002_CmdCode_OUT	WORD	Output	Command Code	2
EIP002_CmdParam1_OUT	WORD	Output	Command Parameter 1	2
EIP002_CmdParam2_OUT	WORD	Output	Command Parameter 2	2
EIP002_CmdData_OUT	****	Output	Command Data	**
EIP002_Status_IN	BOOL[16]	Input	Response Area (Array of bit)	2
EIP002_ErrCode_IN	WORD	Input	Error Code	2
EIP002_ResplInfo1_IN	WORD	Input	Response Information 1	2
EIP002_ResplInfo2_IN	WORD	Input	Response Information 2	2
EIP002_RespData_IN	****	Input	Response Data	**

Data size that can be read or written for an RF Tag in one operation (Maximum)	Data Type
32 bytes	WORD[16], BYTE[32], etc.
256 bytes	WORD[128], BYTE[256], etc.
512 bytes	WORD[256], BYTE[512], etc.
1024 bytes	WORD[512], BYTE[1024], etc.

## 10.2. Tag Sets

The following provides the detailed settings of the tag sets to execute the processing for the tag data links.

Change the data sizes of the global variables marked with red squares to the values described in 10.1. *Global Variables*.

The data sizes marked with red circles are automatically changed.

### ■ Output area (from Controller to RFID Reader/Writer)

Originator Variable (tag set name)		Data Size (Byte)
EIP002_OUT		**
OUT No.	Global Variable Name (tag name)	Data Size (Byte)
1	EIP002_Control_OUT	2
2	EIP002_CmdCode_OUT	2
3	EIP002_CmdParam1_OUT	2
4	EIP002_CmdParam2_OUT	2
5	EIP002_CmdData_OUT	**

### ■ Input area (from RFID Reader/Writer to Controller)

Originator Variable (tag set name)		Data Size (Byte)
EIP002_IN		**
IN No.	Global Variable Name (tag name)	Data Size (Byte)
1	EIP002_Status_IN	2
2	EIP002_ErrCode_IN	2
3	EIP002_RespInfo1_IN	2
4	EIP002_RespInfo2_IN	2
5	EIP002_RespData_IN	**

### 10.3. Tag Data Link Table

The following describes the detailed settings of the tag data link table (connection settings). Select values in "Connection I/O Type" and "Target Variable (Set value of Destination Device: instance number)" corresponding to the data size to use for the tag data links. Refer to 7.3.5. *Setting the Connections* for the setting method.

Connection Name	Connection I/O Type	RPI [ms]	Timeout Value
default_001	Consume Data From/Produce Data To:**	50.0	RPI x 4

Data Size	Connection I/O Type
40 bytes	Consume Data From/Produce Data To:40
264 bytes	Consume Data From/Produce Data To:264
520 bytes	Consume Data From/Produce Data To:520
1032 bytes	Consume Data From/Produce Data To:1032

Connection I/O Type	Input / Output	Target Variable (set value of Destination Device: instance number)	Size (Byte)	Originator Variable (tag set name)	Size (Byte)	Connection Type
Consume Data From/Produce Data To:**	Input	***	**	EIP002_IN	**	Point to Point connection
	Output	***	**	EIP002_OUT	**	Point to Point connection

Data Size	Instance Number for Output	Instance Number for Input
40 bytes	100	110
264 bytes	101	111
520 bytes	102	112
1032 bytes	103	113



## 11. Revision History

Revision code	Date of revision	Revision reason and revision page
01	Jun. 2, 2015	First edition

**OMRON Corporation Industrial Automation Company**

Tokyo, JAPAN

Contact: [www.ia.omron.com](http://www.ia.omron.com)

**Regional Headquarters**

**OMRON EUROPE B.V.**

Wegalaan 67-69, 2132 JD Hoofddorp  
The Netherlands  
Tel: (31)2356-81-300/Fax: (31)2356-81-388

**OMRON ELECTRONICS LLC**

2895 Greenspoint Parkway, Suite 200  
Hoffman Estates, IL 60169 U.S.A  
Tel: (1) 847-843-7900/Fax: (1) 847-843-7787

**OMRON ASIA PACIFIC PTE. LTD.**

No. 438A Alexandra Road # 05-05/08 (Lobby 2),  
Alexandra Technopark,  
Singapore 119967  
Tel: (65) 6835-3011/Fax: (65) 6835-2711

**OMRON (CHINA) CO., LTD.**

Room 2211, Bank of China Tower,  
200 Yin Cheng Zhong Road,  
PuDong New Area, Shanghai, 200120, China  
Tel: (86) 21-5037-2222/Fax: (86) 21-5037-2200

**Authorized Distributor:**

© OMRON Corporation 2015 All Rights Reserved.  
In the interest of product improvement,  
specifications are subject to change without notice.

**Cat. No. P625-E1-01**

0615- (0615)