



Machine Automation Controller NJ-series

EtherNet/IP™ Connection Guide

OMRON Corporation

Vision System
(FZ5 Series)

Network
Connection
Guide

About Intellectual Property Rights and Trademarks

Microsoft product screen shots reprinted with permission from Microsoft Corporation.

Windows is a registered trademark of Microsoft Corporation in the USA and other countries.

ODVA and EtherNet/IP™ are trademarks of ODVA.

EtherCAT(R) is registered trademark and patented technology, licensed by Beckhoff Automation GmbH, Germany.

Sysmac is a trademark or registered trademark of OMRON Corporation in Japan and other countries for OMRON factory automation products.

Company names and product names in this document are the trademarks or registered trademarks of their respective companies.

Table of Contents

1. Related Manuals.....	1
2. Terms and Definitions	2
3. Precautions.....	4
4. Overview	5
5. Applicable Devices and Device Configuration	6
5.1. Applicable Devices.....	6
5.2. Device Configuration.....	7
6. EtherNet/IP Settings.....	9
6.1. Parameters.....	9
6.2. Data Types for Tag Data Links	10
6.3. Global Variables.....	11
6.4. Tag Sets	14
6.5. Tag Data Link Table.....	14
7. EtherNet/IP Connection Procedure.....	15
7.1. Work Flow	15
7.2. Setting up FZ5 Sensor Controller	16
7.3. Setting up Controller	21
7.4. Checking the EtherNet/IP Communications	40
8. Initialization Method.....	43
8.1. Initializing Controller.....	43
8.2. Initializing FZ5 Sensor Controller.....	43
9. Appendix Procedure Using the Project File.....	44
9.1. Work Flow	44
9.2. Setting up Controller	45
10. Revision History.....	47

1. Related Manuals

To ensure system safety, make sure to always read and heed the information provided in all Safety Precautions and Precautions for Safe Use of manuals for each device which is used in the system.

The table below lists the manuals of OMRON Corporation (hereinafter referred to as OMRON) related to this document.

Manufacturer	Cat. No.	Model	Manual name
OMRON	W500	NJ501-□□□□ NJ301-□□□□	NJ-series CPU Unit Hardware User's Manual
OMRON	W501	NJ501-□□□□ NJ301-□□□□	NJ-series CPU Unit Software User's Manual
OMRON	W506	NJ501-□□□□ NJ301-□□□□	NJ Series CPU Unit Built-in EtherNet/IP™ Port User's Manual
OMRON	W504	SYSMAC-SE2□□□□	Sysmac Studio Version 1 Operation Manual
OMRON	0969584-7	W4S1-05□ W4S1-03B	Switching Hub W4S1-series Users Manual
OMRON	9524422-4	FZ5-60□/60□-10 FZ5-110□/110□-10	Image Processing System INSTRUCTION SHEET
OMRON	9910002-2	FZ5-L35□/L35□-10	Image Processing System INSTRUCTION SHEET
OMRON	Z340	FZ5-6□□/6□□-10 FZ5-11□□/11□□-10 FZ5-L35□/L35□-10	Vision Sensor FH/FZ5 Series Vision System User's Manual
OMRON	Z341	FZ5-6□□/6□□-10 FZ5-11□□/11□□-10 FZ5-L35□/L35□-10	Vision Sensor FH/FZ5 Series Vision System Processing Item Function Reference Manual
OMRON	Z342	FZ5-6□□/6□□-10 FZ5-11□□/11□□-10 FZ5-L35□/L35□-10	Vision Sensor FH/FZ5 Series Vision System User's Manual for Communications Settings
OMRON	1636843-6	FZ-M08	LCD monitor INSTRUCTION SHEET

2. Terms and Definitions

Term	Explanation and Definition
Node	<p>Controllers and devices are connected to the EtherNet/IP network via the EtherNet/IP ports. EtherNet/IP recognizes each EtherNet/IP port connected to the network as one node.</p> <p>When a device with two EtherNet/IP ports is connected to the EtherNet/IP network, EtherNet/IP recognizes this device as two nodes. EtherNet/IP achieves the communications between controllers or the communications between controllers and devices by exchanging data between these nodes connected to the network.</p>
Tag	<p>A minimum unit of the data that is exchanged on the EtherNet/IP network is called a tag. The tag is defined as a network variable or as a physical address, and it is allocated to the memory area of each device.</p>
Tag Set	<p>In the EtherNet/IP network, a data unit that consists of two or more tags can be exchanged. The data unit consisting of two or more tags for the data exchange is called a tag set. Up to eight tags can be configured per tag set for OMRON controllers.</p>
Tag data link	<p>In EtherNet/IP, the tag and tag set can be exchanged cyclically between nodes without using the user program. This standard feature on EtherNet/IP is called a tag data link.</p>
Connection	<p>A connection is used to exchange data as a unit within which data concurrency is maintained. The connection consists of tags or tag sets. Creating the concurrent tag data link between the specified nodes is called a "connection establishment". When the connection is established, the tags or tag sets that configure the connection are exchanged between the specified nodes concurrently.</p> <p>Specifying the tag set name (tag name) and specifying the instance number of Assembly Object are given as methods to specify the connection. In Sysmac Studio, the connection is set by specifying the instance number.</p>
Connection Type	<p>There are two kinds of connection types for the tag data link connection, one is a multi-cast connection and the other is a unicast (point-to-point) connection. The multi-cast connection sends an output tag set in one packet to multiple nodes. The unicast connection separately sends one output tag set to each node. Therefore, multi-cast connections can decrease the communications load if one output tag set is sent to multiple nodes.</p>

Term	Explanation and Definition
Originator and Target	<p>To perform tag data links, one node requests the opening of a communications line called a "connection".</p> <p>The node that requests to open the connection is called an "originator", and the node that receives the request is called a "target".</p> <p>Each data for communications is called an "originator variable" and a "target variable".</p> <p>In Sysmac Studio, the instance number is specified in the target variable.</p>
Tag data link parameter	<p>The tag data link parameter is the setting data to perform the tag data link. It includes the data to set tags, tag sets, and connections.</p>
RPI	<p>An abbreviation for Requested Packet Interval.</p> <p>RPI indicates the data I/O refresh cycle that is set for each connection between the originator and the target.</p>

3. Precautions

- (1) Understand the specifications of devices which are used in the system. Allow some margin for ratings and performance. Provide safety measures, such as installing safety circuit, in order to ensure safety and minimize risks of abnormal occurrence.
- (2) To ensure system safety, make sure to always read and heed the information provided in all Safety Precautions and Precautions for Safe Use of manuals for each device which is used in the system.
- (3) The user is encouraged to confirm the standards and regulations that the system must conform to.
- (4) It is prohibited to copy, to reproduce, and to distribute a part or the whole of this document without the permission of OMRON Corporation.
- (5) The information contained in this document is current as of April 2015. It is subject to change without notice for improvement.

The following notation is used in this document.

 WARNING	Indicates a potentially hazardous situation which, if not avoided, will result in minor or moderate injury, or may result in serious injury or death. Additionally there may be significant property damage.
--	--

 Caution	Indicates a potentially hazardous situation which, if not avoided, may result in minor or moderate injury or property damage.
--	---



Precautions for Correct Use

Precautions on what to do and what not to do to ensure proper operation and performance.



Additional Information

Additional information to read as required.

This information is provided to increase understanding or make operation easier.

Symbol



The filled circle symbol indicates operations that you must do.
The specific operation is shown in the circle and explained in text.
This example shows a general precaution for something that must do.

4. Overview

This document describes the procedure for connecting Vision System (FZ5 series) of OMRON to NJ-series Machine Automation Controller (hereinafter referred to as Controller) via EtherNet/IP and provides the procedure for checking their connection.

Hereinafter, the device connected via EtherNet/IP in Vision System is referred to as "FZ5 Sensor Controller".

Refer to *Section 6. EtherNet/IP Settings* and *Section 7. EtherNet/IP Connection Procedure* to understand the setting method and key points to perform the tag data links for EtherNet/IP.



Additional Information

Settings which are described in *7.3. Setting up Controller* are set in advance into the Sysmac Studio compact project file (hereinafter referred to as project file). Refer to *Section 9.*

Appendix Procedure Using the Project File for usage method of the project file. Obtain the latest project file from OMRON.

Name	File name	Version
Sysmac Studio compact project file (Extension: csm2)	OMRON_FZ5_EIP_EV200.csm2	Ver.2.00

5. Applicable Devices and Device Configuration

5.1. Applicable Devices

The applicable devices are as follows:

Manufacturer	Name	Model
OMRON	NJ-series CPU Unit	NJ501-□□□□ NJ301-□□□□
OMRON	FZ5 Sensor Controller LCD-integrated Controller Box-type Controller	FZ5-6□□/6□□-10 FZ5-11□□/11□□-10 FZ5-L35□/L35□-10
OMRON	5 Megapixel Digital Camera 2 Megapixel Digital Camera 0.3 Megapixel Digital Camera 0.3 Megapixel High-Speed Camera 0.3 Megapixel Small Digital Camera 0.3 Megapixel Small Digital Pen-Shaped Camera Intelligent Compact Camera	FZ-SC5M2/S5M2 FZ-SC2M/S2M FZ-SC/S FZ-SHC/SH FZ-SFC/SF FZ-SPC/SP FZ-SQ010F/SQ050F FZ-SQ100F/SQ100N



Precautions for Correct Use

As applicable devices above, the devices with the models and versions listed in 5.2. *Device Configuration* are actually used in this document to describe the procedure for connecting devices and checking the connection.

You cannot use devices with versions lower than the versions listed in 5.2.

To use the above devices with models not listed in 5.2. or versions higher than those listed in 5.2., check the differences in the specifications by referring to the manuals before operating the devices.



Additional Information

This document describes the procedure to establish the network connection. It does not provide information on operation, installation or wiring method which is not related to the connection procedure. It also does not describe the functionality or operation of the devices. Refer to the manuals or contact the device manufacturer.

5.2. Device Configuration

The hardware components to reproduce the connection procedure of this document are as follows:

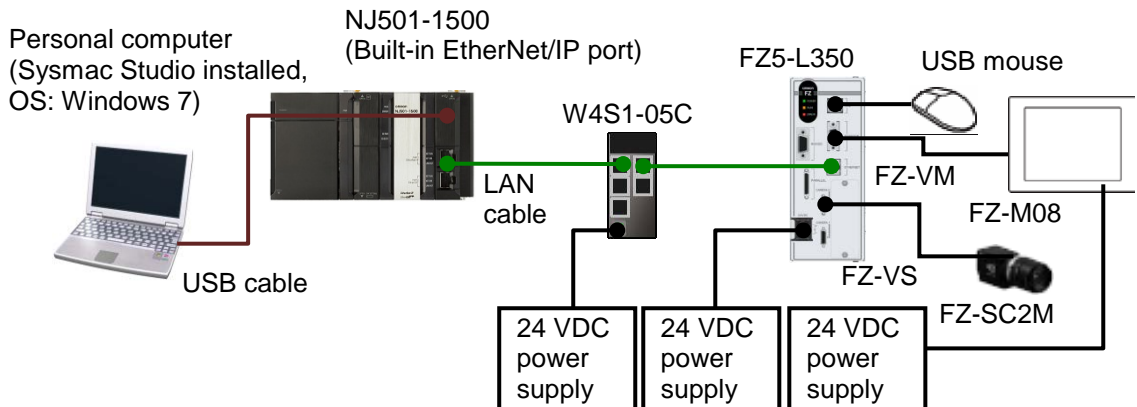

Manufacturer	Name	Model	Version
OMRON	NJ-series CPU Unit (Built-in EtherNet/IP port)	NJ501-1500	Ver.1.09
OMRON	Power Supply Unit	NJ-PA3001	
OMRON	Switching hub	W4S1-05C	Ver.1.00
-	24 VDC power supply (For Switching hub)	-	
OMRON	Sysmac Studio	SYSMAC-SE2[] [] [] [] [] []	Ver.1.10
-	Personal computer (OS: Windows 7)	-	
-	USB cable (USB 2.0 type B connector)	-	
-	LAN cable (STP (shielded, twisted-pair) cable of Ethernet category 5 or higher)	-	
OMRON	FZ5 Sensor Controller	FZ5-L350	Ver.5.32
OMRON	Camera	FZ-SC2M	
OMRON	Camera cable	FZ-VS[]	
OMRON	Monitor (analog RGB monitor)	FZ-M08	
OMRON	Monitor cable	FZ-VM	
-	USB mouse	-	
-	24 VDC power supply (For FZ5 Sensor Controller)	-	
-	24 VDC power supply (For Monitor)	-	

 **Precautions for Correct Use**

Update Sysmac Studio to the version specified in this clause or higher version.
 If you use a version lower than the one specified in this clause, procedures described in Section 7. and subsequent sections may not be applicable. In that case, use the equivalent procedures described in this document by referring to the *Sysmac Studio Version 1 Operation Manual* (Cat. No. W504).



Additional Information

For specifications of 24 VDC power supply available for Switching hub, refer to the *Switching Hub W4S1-series Users Manual* (Cat. No. 0969584-7).



Additional Information

For specifications of 24 VDC power supply available for FZ5 Sensor Controller, refer to the *Image Processing System INSTRUCTION SHEET* (Cat. No. 9524422-4/ 9910002-2).



Additional Information

For specifications of 24 VDC power supply available for Monitor, refer to the *LCD monitor INSTRUCTION SHEET* (Cat. No. 1636843-6).



Additional Information

The system configuration in this document uses USB for the connection to Controller. For information on how to install a USB driver, refer to *A-1 Driver Installation for Direct USB Cable Connection* of the *Sysmac Studio Version 1 Operation Manual* (Cat. No. W504).

6. EtherNet/IP Settings

This section describes the specifications of parameters, global variables, tag sets, and a tag data link table that are all defined in this document.

Hereinafter, FZ5 Sensor Controller is referred to as "Destination Device" in some descriptions.

6.1. Parameters

The parameter settings that are set in this document are as follows:

6.1.1. EtherNet/IP Communications Settings

The parameters required for connecting Controller and Destination Device via EtherNet/IP are given below.

Item	Controller	FZ5 Sensor Controller
IP address	192.168.250.1	192.168.250.2
Subnet mask	255.255.255.0	255.255.255.0

6.1.2. Setting Up FZ5 Sensor Controller

The parameters for FZ5 Sensor Controller are given below.

Item	Set value
Fieldbus	EtherNet/IP
Output control	Handshaking (Default).
Timeout [s]	10.0 (Default)



Precautions for Correct Use

In order to prevent a phenomenon that a change in the status of each signal cannot be detected by the target device, it is recommended that you set the output control setting for FZ5 Sensor Controller to Handshaking.

When the output control of FZ5 Sensor Controller is set to None, the originator device may not correctly detect a change in the status of a signal from FZ5 Sensor Controller if RPI is longer than the output time (ON/OFF) on FZ5 Sensor Controller.

For details, refer to *EtherNet/IP Communications Cycle (RPI) in Data Exchange with EtherNet/IP in Communicating with EtherNet/IP in Section 2. Methods for Connecting and Communicating with External Devices of the Vision Sensor FH/FZ5 Series Vision System User's Manual for Communications Settings (Cat. No. Z342).*

6.2. Data Types for Tag Data Links

The following data types are used for the data in the tag data links of Destination Device.

■ Definition of the data type to access the signals (Unions)

This data type is used to access the control signals and status signals.

Data type name	Data type
U_EIPFlag	UNION
F	BOOL[32]
W	DWORD

■ Definition of the data type to access the command area (Structures)

This data type is used to access the command area.

Data type name	Data type	Destination Device data
S_EIPOutput	STRUCT	-
ControlFlag	U_EIPFlag	Control signal (32 bits)
CommandCode	DWORD	Command code (CMD-CODE)
CommandParam1	DINT	Command parameter (CMD-PARAM)
CommandParam2	DINT	
CommandParam3	DINT	

■ Definition of the data type to access the response/output areas (Structures)

This data type is used to access the response/output areas.

Data type name	Data type	Destination Device data
S_EIPInput	STRUCT	-
StatusFlag	U_EIPFlag	Control output (32 bits)
CommandCodeEcho	DWORD	Command code (CMD-CODE)
ResponseCode	DWORD	Response code (RES-CODE)
ResponseData	DINT	Response data (RES-DATA)
OutputData	DINT[8]	Output data 0 to 7 (DATA 0 to 7)



Additional Information

For details on structures and unions, refer to *Accessing Communications Areas Using Variables with NJ-series Controllers* in *Communicating with EtherNet/IP* in Section 2. *Methods for Connecting and Communicating with External Devices* of the *Vision Sensor FH/FZ5 Series Vision System User's Manual for Communications Settings* (Cat. No. Z342).

6.3. Global Variables

The Controller treats the data in tag data links as global variables. The settings of the global variables are the following.

Name	Data type	Network publish	Destination Device allocation	Data size (byte)
EIPOutput	S_EIPOutput	Output	Command code	20
EIPInput	S_EIPInput	Input	Response Code	48

■EIPOutput Configuration

Destination Device data	Variable name	Data type
Control signal (32 bits)		U_EIPFlag
	EIPOutput.ControlFlag.F ^{*1}	BOOL[32]
	EIPOutput.ControlFlag.W	DWORD
Command code (CMD-CODE)	EIPOutput.CommandCode	DWORD
Command parameter (CMD-PARAM)	EIPOutput.CommandParam1	DINT
	EIPOutput.CommandParam2	DINT
	EIPOutput.CommandParam3	DINT

*1: Details on allocation of control signal

Allocation of EIPOutput.ControlFlag.F variable

15	14	13	12	11	10	9	8	7	6	5	4	3	2	1	0
ERCLR							XEXE							STEP	EXE

31	30	29	28	27	26	25	24	23	22	21	20	19	18	17	16
															DSA

EXE: Command Execution Bit: Turns ON to execute a command.

STEP: Measure Bit: Turns ON to execute a measurement.

XEXE: Flow Command Request Bit: Turns ON to request execution of a command during execution of fieldbus flow control.

ERCLR: Error Clear Bit: Turns ON to clear the ERR signal from FZ5 Sensor Controller.

DSA: Data Output Request Bit: Turns ON to request the next data output.

■ EIPInput Configuration

Destination Device data	Variable name	Data type
Control output (32 bits)		U_EIPFlag
	EIPInput.StatusFlag.F* ¹	BOOL[32]
	EIPInput.StatusFlag.W	DWORD
Command code (CMD-CODE)	EIPInput.CommandCodeEcho	DWORD
Response Code (RES-CODE)	EIPInput.ResponseCode	DWORD
Response data (RES-DATA)	EIPInput.ResponseData	DINT
Output data 0 (DATA0)	EIPInput.OutputData	DINT[8]
Output data 1 (DATA1)		
Output data 2 (DATA2)		
Output data 3 (DATA3)		
Output data 4 (DATA4)		
Output data 5 (DATA5)		
Output data 6 (DATA6)		
Output data 7 (DATA7)		

*1: Details on allocation of control signal

Allocation of EIPInput.StatusFlag.F variable

15	14	13	12	11	10	9	8	7	6	5	4	3	2	1	0
ERR					XWAIT	XBUSY	XFLG				RUN	OR		BUSY	FLG

31	30	29	28	27	26	25	24	23	22	21	20	19	18	17	16
															GATE

FLG: Command Completion Bit: Turns ON when command execution is completed.

BUSY: Command Busy Bit: Turns ON when command execution is in progress.

OR: Overall Judgement: Turns ON when the overall judgement is NG.

RUN: Run Mode: Turns ON while FZ5 Sensor Controller is in Run Mode.

XFLG: Flow Command Completion Bit: Turns ON when execution of a command that was input during the execution of fieldbus flow control has been completed. (i.e., when XBUSY turns OFF)

XBUSY: Flow Command Busy Bit: Turns ON when execution of a command that was input during execution of fieldbus flow control is in progress.

XWAIT: Flow Command Wait Bit: Turns ON when a command can be input during the execution of fieldbus flow control.

ERR: Error Signal: Turned ON when FZ5 Sensor Controller detects an error signal.

GATE: Data Output Completion Bit: Turns ON when data output is completed.



Precautions for Correct Use

If the data size of tag data links for Destination Device is an odd-numbered byte, use BYTE type to define, do not use BOOL type.



Additional Information

For details on command codes and response codes, refer to *Command Details for PLC Link, EtherNet/IP, and EtherCAT* in *Command Control* in *Section 3. Appendices of the Vision Sensor FH/FZ5 Series Vision System User's Manual for Communications Settings* (Cat. No. Z342).



Additional Information

With Sysmac Studio, two methods can be used to specify an array for a data type. After specifying, (1) is converted to (2) and the data type is always displayed as (2).

(1)BOOL[16] / (2) ARRAY[0..15] OF BOOL

In this document, the data type is simplified by displaying BOOL[16].

(The example above means a BOOL data type with sixteen array elements.)

6.4. Tag Sets

This clause provides the detailed settings of the tag sets to execute the processing for the tag data links.

Data in the tag sets are allocated in the following OUT No. and IN No.

■ Output area (from Controller to FZ5 Sensor Controller)

Originator variable (tag set name)		Data size (byte)
EIP002_OUT		20
OUT No.	Global variable name (tag name)	Data size (byte)
1	EIPOutput	20

■ Input area (from FZ5 Sensor Controller to Controller)

Originator variable (tag set name)		Data size (byte)
EIP002_IN		48
IN No.	Global variable name (tag name)	Data size (byte)
1	EIPInput	48

6.5. Tag Data Link Table

This clause describes the detailed settings of the tag data link table (connection settings).

On FZ5 Sensor Controller, set the connection type to **Point to Point** for both input and output. Set the timeout value so that it is longer than FZ5 Sensor Controller's measurement processing time.

When the measurement interval is short, the measurement processing load is high, or command processing for operations such as scene group changing is time-consuming, FZ5 Sensor Controller prioritizes measurement and control processing over communication processing. As a result, communication between an external device and FZ5 Sensor Controller may be temporarily interrupted, and a communication error may occur.

In this case, set the communication error timeout time longer than FZ5 Sensor Controller's processing time.

The values in a red frame are taken from the values in EDS file of Destination Device.

Connection Name	Connection I/O Type	RPI (ms)	Timeout Value
default_001	Consume Data From/Produce Data To	50.0	RPI x 4

Connection I/O Type	Input / Output	Target variable (Set value of Destination Device: instance number)	Size (byte)	Originator Variable (tag set name)	Size (byte)	Connection Type
Consume Data From/Produce Data To	Input	101	48	EIP002_IN	48	Point to Point connection
	Output	100	20	EIP002_OUT	20	Point to Point connection

7. EtherNet/IP Connection Procedure

This section describes the procedure for connecting FZ5 Sensor Controller and Controller on the EtherNet/IP network.

This document explains the procedures for setting up Controller and FZ5 Sensor Controller based on the factory default setting. For the initialization, refer to *Section 8. Initialization Method*.

7.1. Work Flow

Take the following steps to set the tag data link for EtherNet/IP.

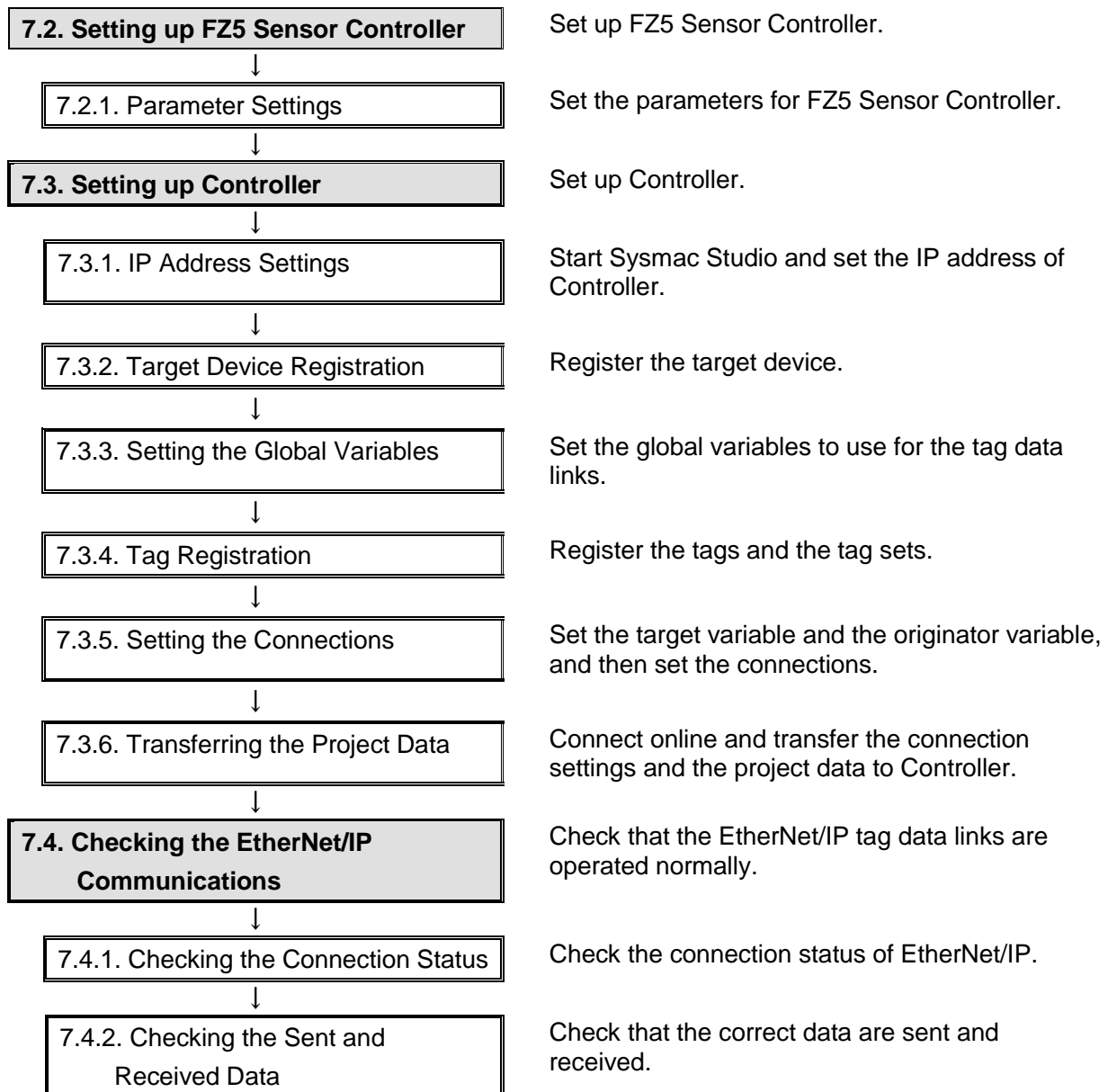



7.2. Setting up FZ5 Sensor Controller

Set up FZ5 Sensor Controller.

7.2.1. Parameter Settings

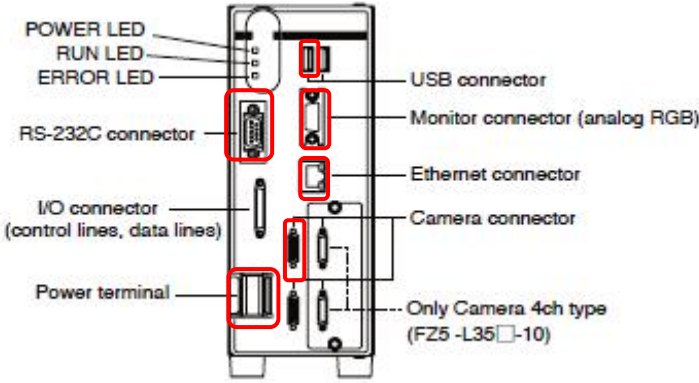
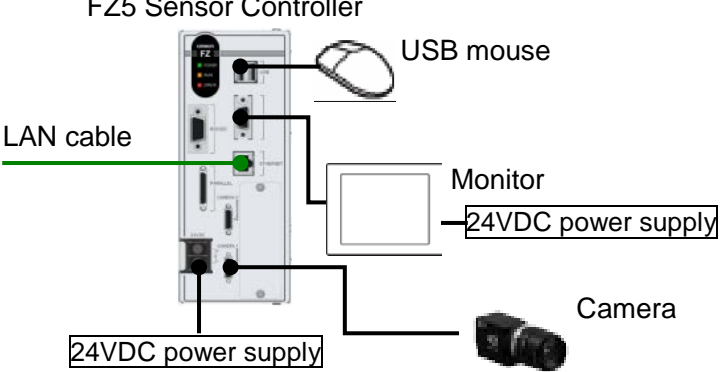
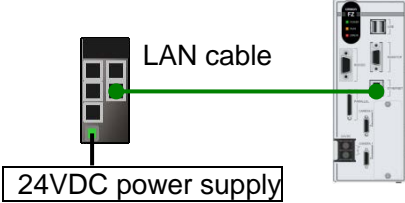
Set the parameters for FZ5 Sensor Controller.

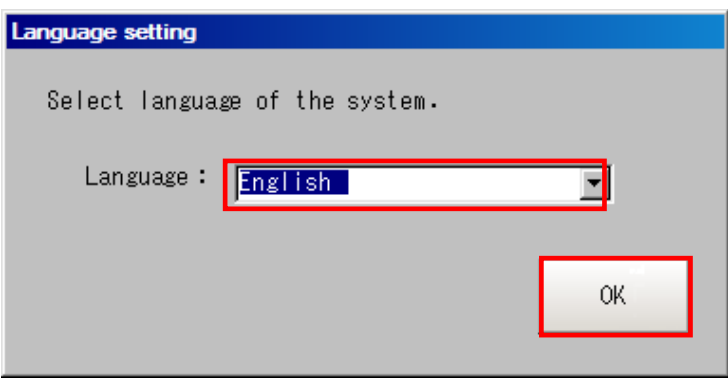
<p>1</p>	<p>Check the positions of the connectors on FZ5 Sensor Controller by referring to the right figure.</p>	 <p>Diagram of the FZ5 Sensor Controller rear panel. Labels on the left: POWER LED, RUN LED, ERROR LED, RS-232C connector, I/O connector (control lines, data lines), Power terminal. Labels on the right: USB connector, Monitor connector (analog RGB), Ethernet connector, Camera connector, Only Camera 4ch type (FZ5 -L35□-10). Red boxes highlight the RS-232C, I/O, and Power terminal connectors.</p>
<p>2</p>	<p>As shown in 5.2. <i>Device Configuration</i>, connect Camera, Monitor, USB mouse, 24 VDC power supply (For FZ5 Sensor Controller), and LAN cable to FZ5 Sensor Controller. Connect 24 VDC power supply (For Monitor) to Monitor.</p>	 <p>Diagram showing the FZ5 Sensor Controller with the following connections: USB mouse to the USB connector; LAN cable to the Ethernet connector; 24VDC power supply to the Power terminal; Monitor to the Monitor connector; and Camera to the Camera connector. A second 24VDC power supply is connected to the Monitor.</p>
<p>3</p>	<p>Connect FZ5 Sensor Controller to Switching hub with LAN cable. Connect 24 VDC power supply (For Switching hub) to Switching hub.</p>	 <p>Diagram showing the FZ5 Sensor Controller connected to a switching hub. A LAN cable connects the Ethernet port of the controller to a port on the switching hub. A 24VDC power supply is connected to the switching hub.</p>
<p>4</p>	<p>Turn ON the power supply to FZ5 Sensor Controller and Monitor.</p>	

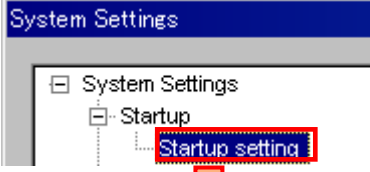
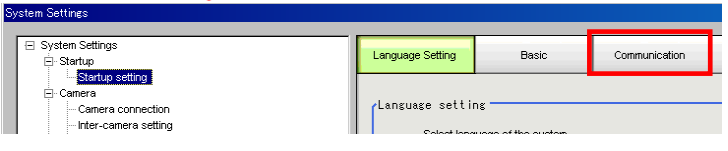
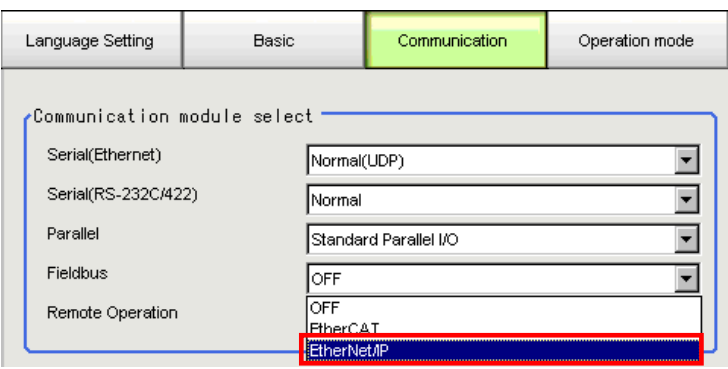
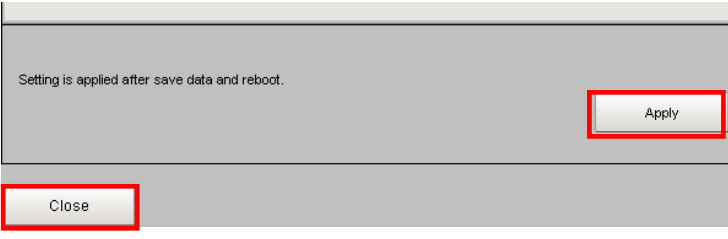
<p>5 The Language setting Dialog Box is displayed on Monitor connected to FZ5 Sensor Controller only at the initial start. Select English and click OK.</p> <p>Check that your desired Language is selected and click Yes.</p>	 
<p>6 Select System Settings from the Tool Menu on Monitor of FZ5 Sensor Controller.</p>	
<p>7 Select System Settings – Startup - Startup setting from the tree.</p> <p>Select the Communication Tab in the right figure.</p>	 
<p>8 The Communication module select Field is displayed. Select EtherNet/IP from the Fieldbus pull-down list.</p> <p>Then, click Apply in the lower part of the displayed screen. Click Close to close the System Settings Dialog Box.</p> <p>*After the data set in the System Settings Window are saved and then FZ5 Sensor Controller is restarted as shown on the right, the settings become enabled.</p>	 

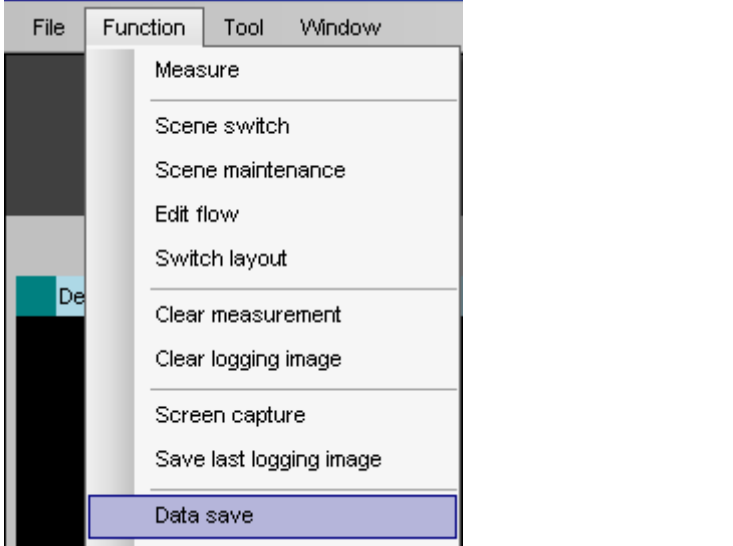
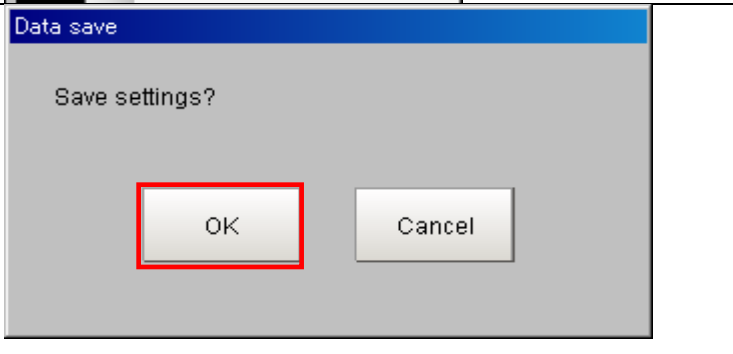
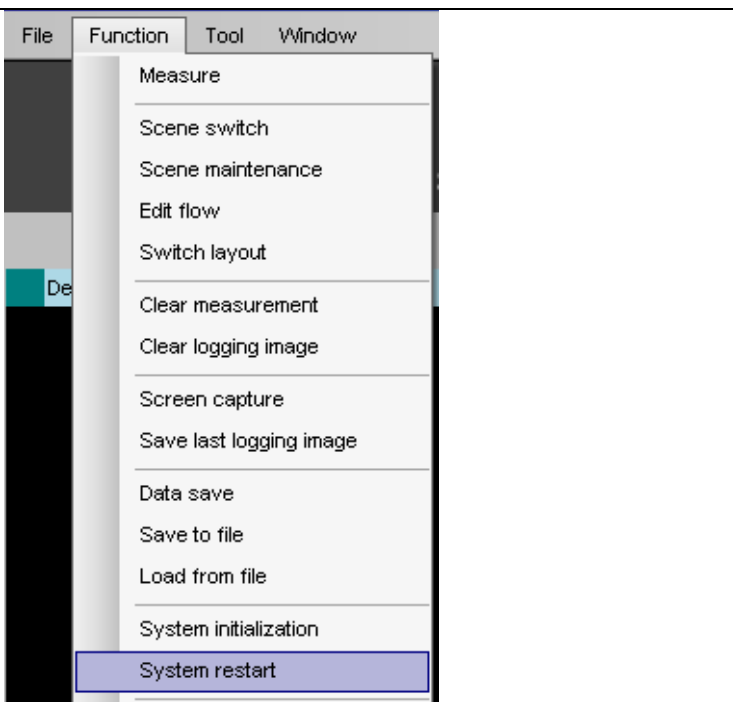
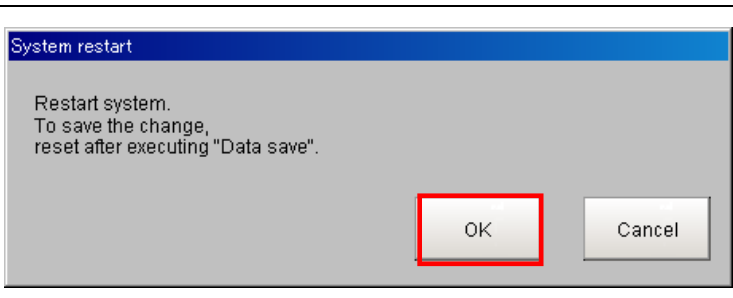
<p>9 Select Data save from the Function Menu.</p>	 <p>The screenshot shows the 'Function' menu open in a software application. The menu items are: Measure, Scene switch, Scene maintenance, Edit flow, Switch layout, Clear measurement, Clear logging image, Screen capture, Save last logging image, and Data save. The 'Data save' option at the bottom is highlighted with a blue selection bar.</p>
<p>10 The Data save Dialog Box is displayed. Check the contents and click OK.</p>	 <p>The screenshot shows a dialog box titled 'Data save'. It contains the text 'Save settings?' and two buttons: 'OK' and 'Cancel'. The 'OK' button is highlighted with a red rectangular border.</p>
<p>11 Select System restart from the Function Menu.</p>	 <p>The screenshot shows the 'Function' menu open, similar to step 9. The menu items are: Measure, Scene switch, Scene maintenance, Edit flow, Switch layout, Clear measurement, Clear logging image, Screen capture, Save last logging image, Data save, Save to file, Load from file, System initialization, and System restart. The 'System restart' option at the bottom is highlighted with a blue selection bar.</p>
<p>12 The System restart Dialog Box is displayed. Check the contents and click OK.</p>	 <p>The screenshot shows a dialog box titled 'System restart'. It contains the text 'Restart system. To save the change, reset after executing "Data save".' and two buttons: 'OK' and 'Cancel'. The 'OK' button is highlighted with a red rectangular border.</p>

13 After restarting, select **System Settings** from the Tool Menu.



14 Select **System Settings - Communication - Ethernet(Normal(UDP))** from the tree.

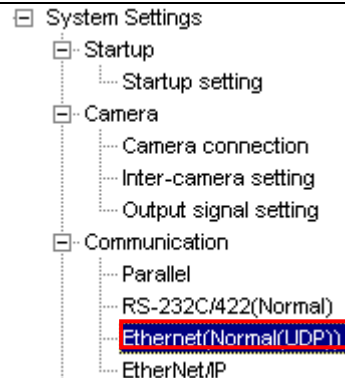

15 The dialog box on the right is displayed. Select *Use the following IP address* in the *Address setting* Field and enter the following values.

- IP address: 192.168.250.2
- Subnet mask: 255.255.255.0

After setting, click **Apply**.

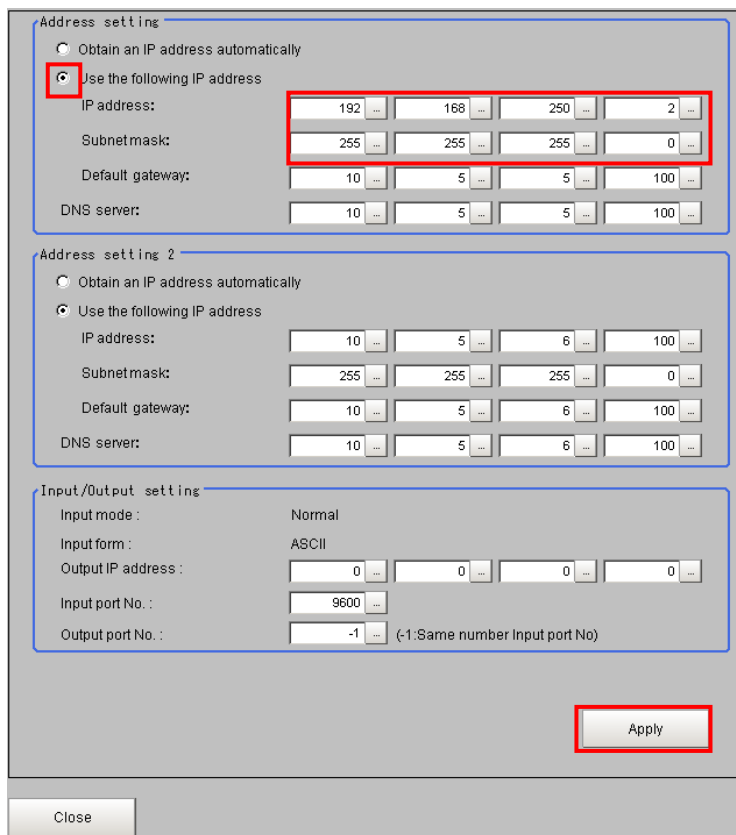

*To change a value, click the  Button which is in the right of each octet of IP address. The numeric keyboard is displayed. Enter values using the mouse. After entering the values, click **OK** on the numeric keyboard.

*How to change values

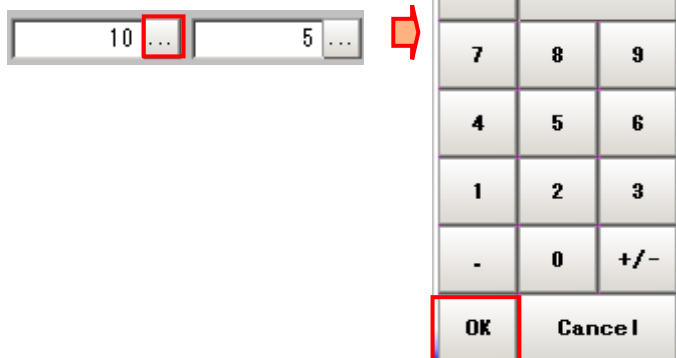

16 Select **System Settings - Communication - EtherNet/IP** from the tree.

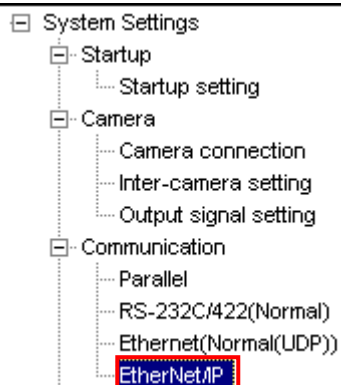

17 The Setting Tab Page is displayed.
Check the following values.

- Output control: *Handshaking*
- Timeout [s]: *10.0*

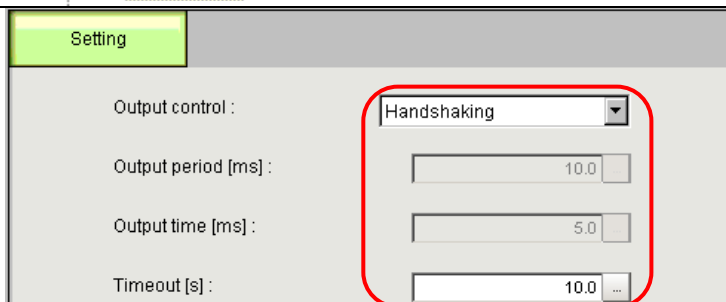

Click **Close** to close the System Settings Window.



18 In the same way as steps 9 and 10, select **Data save** from the Function Menu.

19 In the same way as steps 11 and 12, select **System restart** from the Function Menu.



7.3. Setting up Controller

Set up Controller.

7.3.1. IP Address Settings

Start Sysmac Studio and set the IP address of Controller.

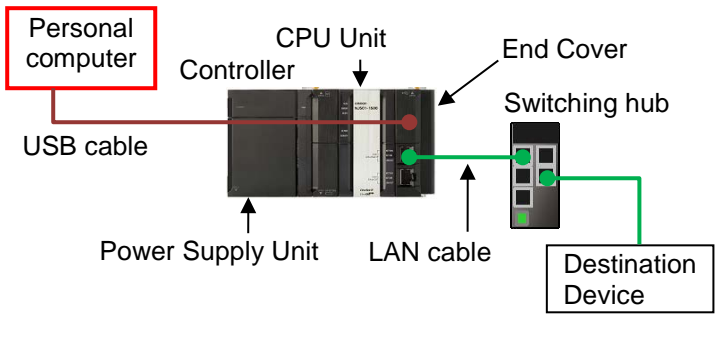
Install Sysmac Studio and USB driver in Personal computer beforehand.

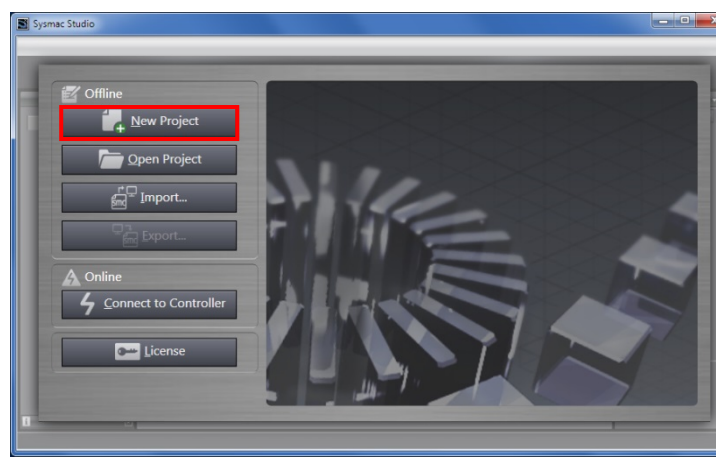
<p>1 Connect LAN cable to the Built-in EtherNet/IP port (PORT1) of Controller, and connect the USB cable to the peripheral (USB) port. As shown in 5.2. <i>Device Configuration</i>, connect Personal computer and Switching hub to Controller.</p>	 <p>The diagram illustrates the hardware connections for the controller. A Personal computer (indicated by a red box) is connected to the Controller's USB port. A Power Supply Unit is connected to the Controller's power input. A LAN cable connects the Controller's PORT1 to a Switching hub, which is then connected to a Destination Device. The End Cover is also shown on the Controller.</p>
<p>2 Start Sysmac Studio.</p> <p>*If a confirmation dialog for an access right is displayed at start, execute a selection to start.</p>	 <p>The Sysmac Studio logo is displayed, consisting of a blue square with a white gear icon and the text 'Sysmac Studio' below it.</p>
<p>3 Sysmac Studio starts. Click New Project.</p>	 <p>The screenshot shows the Sysmac Studio software interface. The 'New Project' button is highlighted with a red box. The interface includes buttons for 'Offline', 'New Project', 'Open Project', 'Import...', 'Export...', 'Online', 'Connect to Controller', and 'License'. The background of the window shows a 3D rendering of a factory floor.</p>

4 Project Properties Dialog Box is displayed.

*In this document, New Project is used as the Project name.

Check that the device used is shown in the *Category* and the *Device* Fields of Select Device.

Select an applicable version from the pull-down list of Version.

*Although 1.09 is selected in this document for example, select the version you actually use.

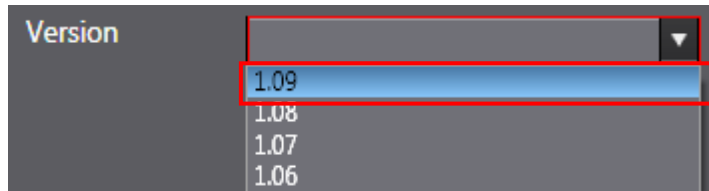
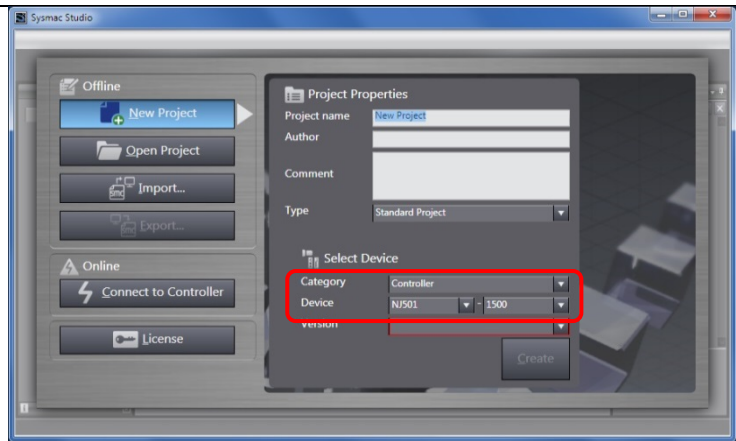

5 Click **Create**.

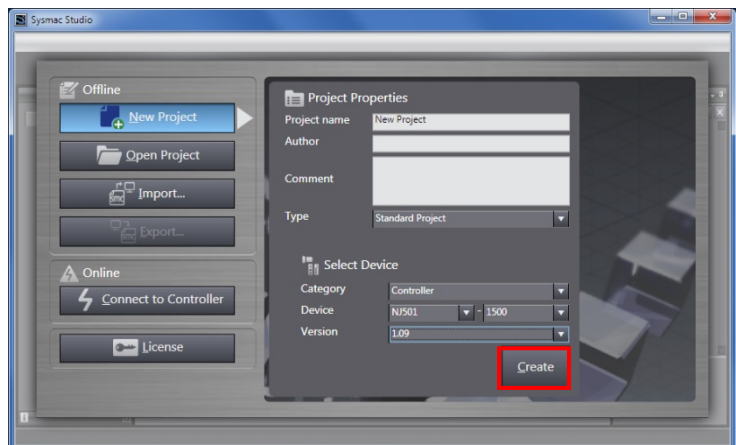

6 The New Project is displayed.

The following panes are displayed in this window.

Left: Multiview Explorer

Top right: Toolbox

Bottom right: Controller Status Pane

Middle top: Edit Pane

The following tab pages are displayed at the middle bottom of the window.

Output Tab Page

Build Tab Page

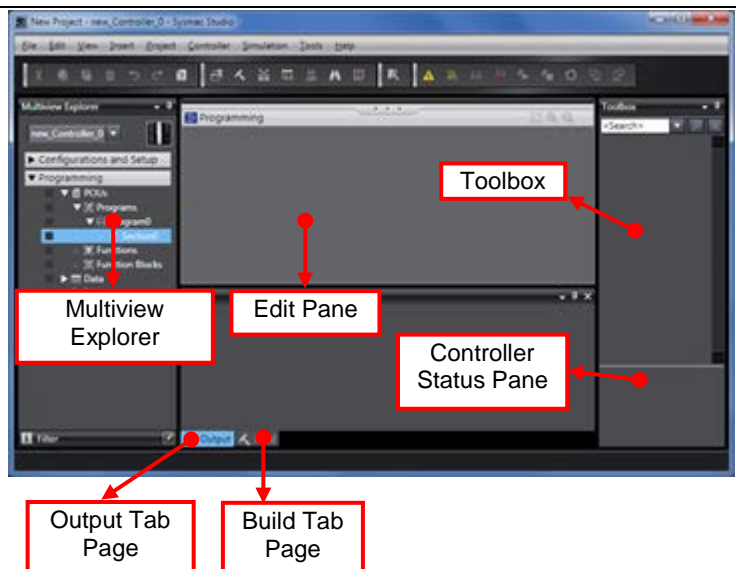

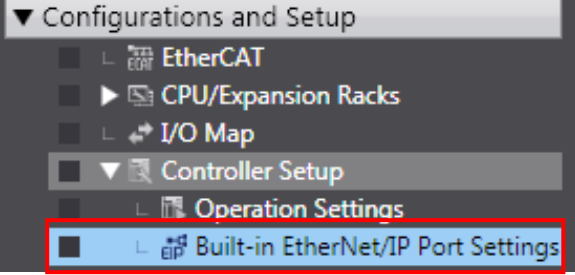
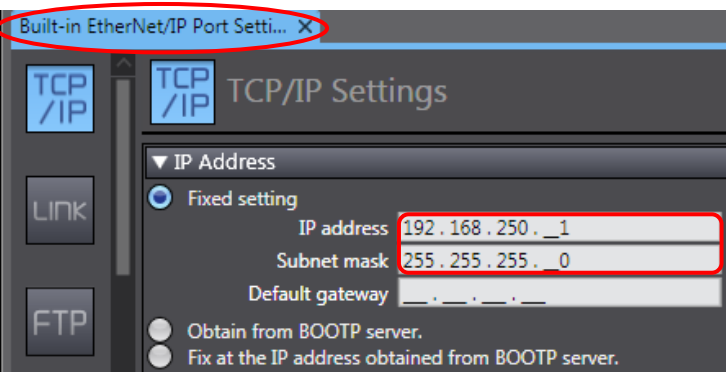
<p>7 Double-click Built-in EtherNet/IP Port Settings under Configurations and Setup - Controller Setup in the Multiview Explorer.</p>	
<p>8 The Built-in EtherNet/IP Port Settings Tab Page is displayed in the Edit Pane. Check that the following settings are made in the <i>IP Address</i> Field. IP address: 192.168.250.1 Subnet mask: 255.255.255.0</p>	

7.3.2. Target Device Registration

Register the target device.

- 1 Select **EtherNet/IP Connection Settings** from the Tools Menu.

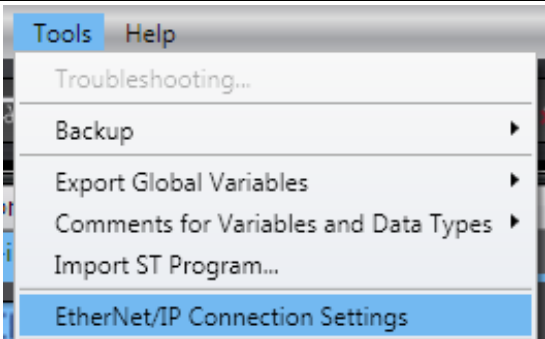

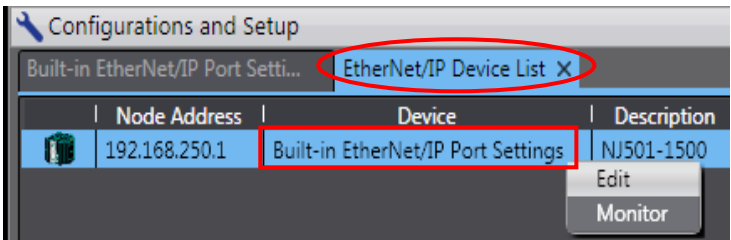
- 2 The EtherNet/IP Device List Tab Page is displayed in the Edit Pane.
While the Built-in EtherNet/IP Port Settings is being selected, right-click and select **Edit** from the menu.

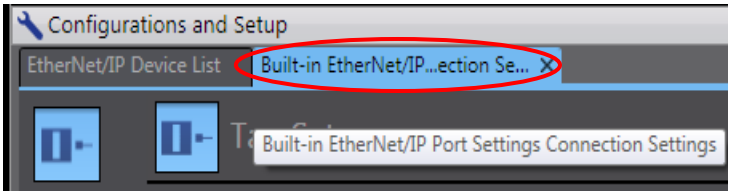

Node Address	Device	Description
192.168.250.1	Built-in EtherNet/IP Port Settings	NJ501-1500
- 3 The Built-in EtherNet/IP Port Settings Connection Settings Tab Page is displayed in the Edit Pane.

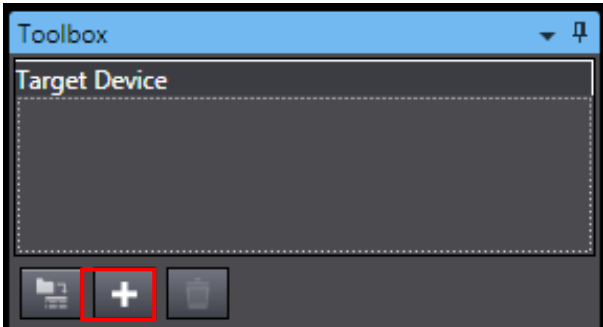

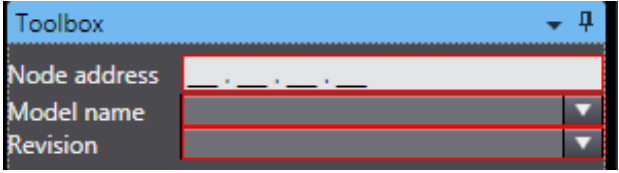
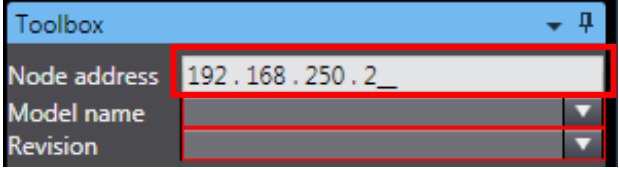
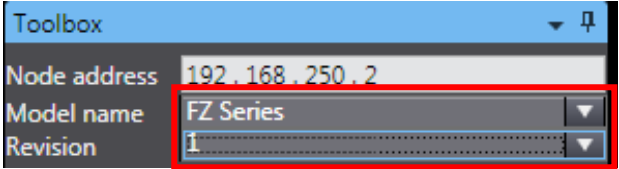
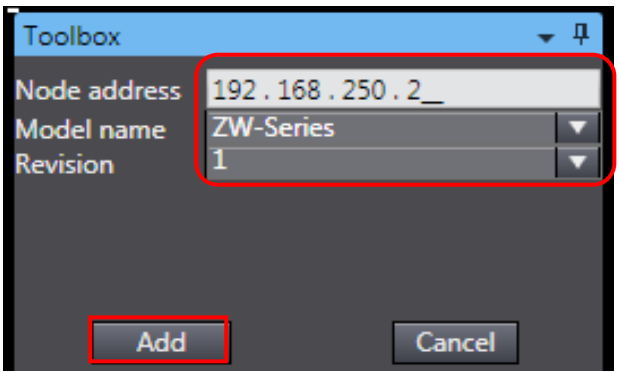
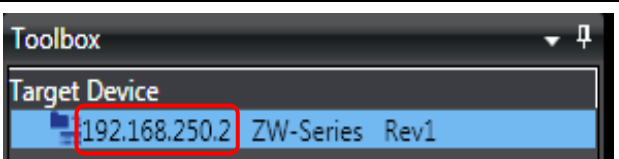
- 4 Click the + Button in Toolbox.



<p>5</p> <p>Data fields of the target device registration are displayed.</p> <p>Enter 192.168.250.2 in the Node address Field.</p> <p>Select the following values from the pull-down lists of Model name and Revision.</p> <p>Model name: FZ Series</p> <p>Revision: 1</p>	 <p style="text-align: center;">↓</p>  <p style="text-align: center;">↓</p> 
<p>6</p> <p>Check the settings and click Add.</p>	
<p>7</p> <p>192.168.250.2 is registered in Target Device of Toolbox.</p>	

7.3.3. Setting the Global Variables

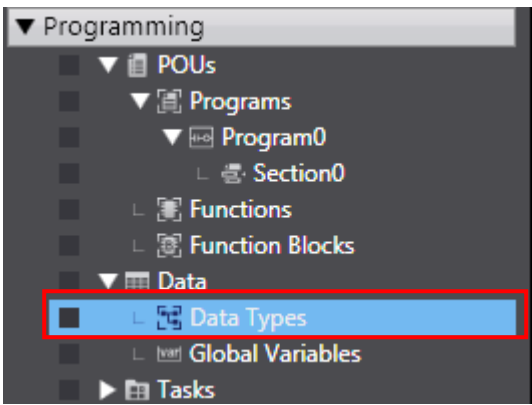
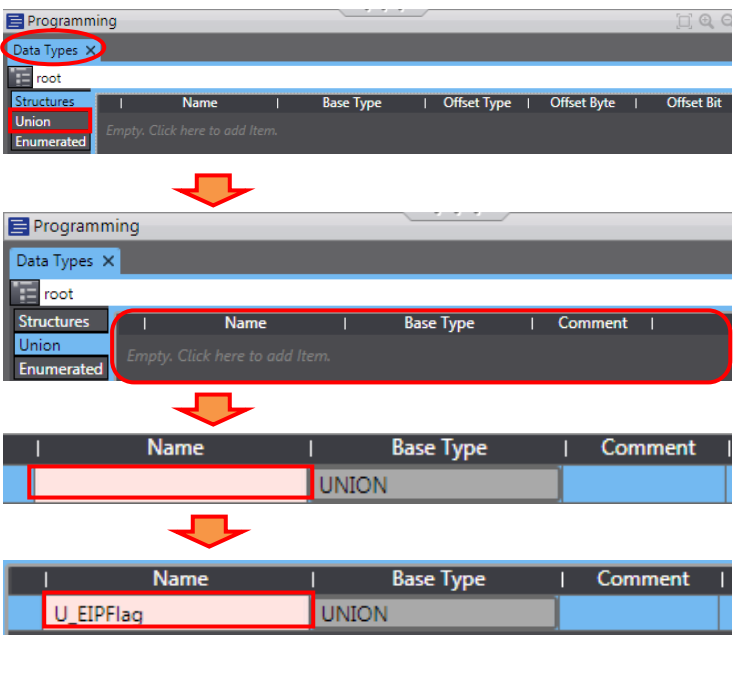
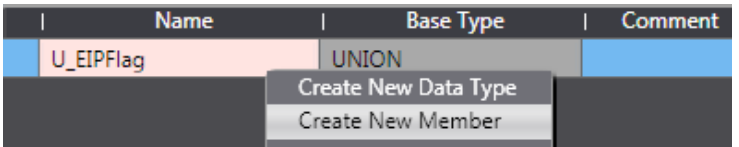
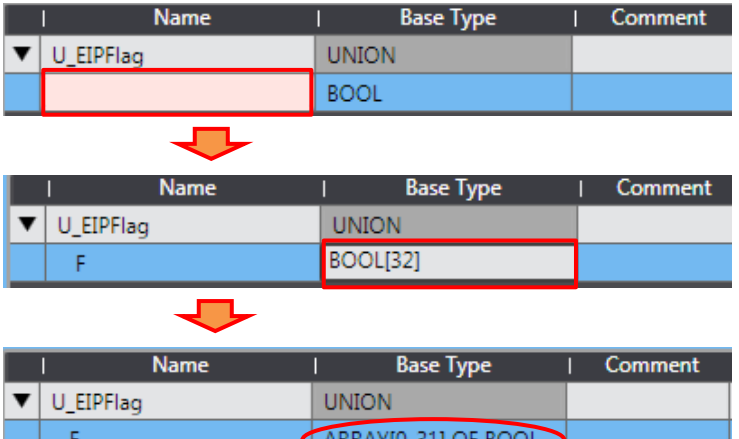
Set the global variables to use for the tag data links.

<p>1 Double-click Data Types under Programming - Data in the Multiview Explorer.</p>	
<p>2 The Data Types Tab Page is displayed. Click the Union Side Tab.</p> <p>The Union Data Type Editor is displayed.</p> <p>Click a column under the <i>Name</i> Column to enter a new data type.</p> <p>Enter <i>U_EIPFlag</i> in the <i>Name</i> Column.</p>	
<p>3 After entering, right-click and select Create New Member from the menu.</p>	
<p>4 Enter <i>F</i> in the <i>Name</i> Column.</p> <p>Enter <i>BOOL[32]</i> in the <i>Base Type</i> Column.</p> <p>*After entering, the value changes to ARRAY[0..31] OF BOOL as shown on the right.</p>	

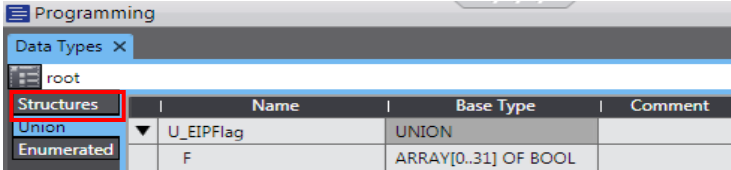
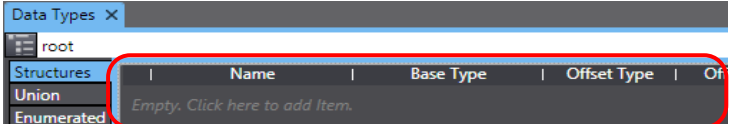
5	<p>In the same way as steps 3 and 4, enter the following data in the new columns.</p> <p style="margin-left: 20px;">Name: <i>W</i></p> <p style="margin-left: 20px;">Base Type: <i>DWORD</i></p>	<table border="1" style="width: 100%; border-collapse: collapse;"> <thead> <tr> <th style="width: 10%;"></th> <th style="width: 40%;">Name</th> <th style="width: 30%;">Base Type</th> <th style="width: 20%;">Comment</th> </tr> </thead> <tbody> <tr> <td>▼</td> <td>U_EIPFlag</td> <td>UNION</td> <td></td> </tr> <tr> <td></td> <td>F</td> <td>ARRAY[0..31] OF BOOL</td> <td></td> </tr> <tr style="border: 2px solid red;"> <td></td> <td>W</td> <td>DWORD</td> <td></td> </tr> </tbody> </table>		Name	Base Type	Comment	▼	U_EIPFlag	UNION			F	ARRAY[0..31] OF BOOL			W	DWORD																											
	Name	Base Type	Comment																																									
▼	U_EIPFlag	UNION																																										
	F	ARRAY[0..31] OF BOOL																																										
	W	DWORD																																										
6	<p>Click the Structures Side Tab in the Edit Pane.</p> <p>The Structure Data Type Editor is displayed.</p> <p>Click a column under the <i>Name</i> Column to enter a new data type.</p> <p>Enter <i>S_EIPOutput</i> in the <i>Name</i> Column.</p>	 <p style="text-align: center;">↓</p>  <p style="text-align: center;">↓</p> <table border="1" style="width: 100%; border-collapse: collapse;"> <thead> <tr> <th style="width: 10%;"></th> <th style="width: 40%;">Name</th> <th style="width: 30%;">Base Type</th> <th style="width: 10%;">Offset Type</th> <th style="width: 10%;">Offset Byte</th> </tr> </thead> <tbody> <tr> <td></td> <td></td> <td>STRUCT</td> <td>NJ</td> <td></td> </tr> </tbody> </table> <p style="text-align: center;">↓</p> <table border="1" style="width: 100%; border-collapse: collapse;"> <thead> <tr> <th style="width: 10%;"></th> <th style="width: 40%;">Name</th> <th style="width: 30%;">Base Type</th> <th style="width: 10%;">Offset Type</th> <th style="width: 10%;">Offset Byte</th> </tr> </thead> <tbody> <tr style="border: 2px solid red;"> <td></td> <td>S_EIPOutput</td> <td>STRUCT</td> <td>NJ</td> <td></td> </tr> </tbody> </table>		Name	Base Type	Offset Type	Offset Byte			STRUCT	NJ			Name	Base Type	Offset Type	Offset Byte		S_EIPOutput	STRUCT	NJ																							
	Name	Base Type	Offset Type	Offset Byte																																								
		STRUCT	NJ																																									
	Name	Base Type	Offset Type	Offset Byte																																								
	S_EIPOutput	STRUCT	NJ																																									
7	<p>After entering, right-click and select Create New Member from the menu.</p>	<table border="1" style="width: 100%; border-collapse: collapse;"> <thead> <tr> <th style="width: 10%;"></th> <th style="width: 40%;">Name</th> <th style="width: 30%;">Base Type</th> </tr> </thead> <tbody> <tr> <td></td> <td>S_EIPOutput</td> <td>STRUCT</td> </tr> </tbody> </table> <div style="border: 1px solid gray; padding: 5px; width: fit-content; margin: 5px auto;"> <p style="text-align: center;">Create New Data Type</p> <p style="text-align: center;">Create New Member</p> </div>		Name	Base Type		S_EIPOutput	STRUCT																																				
	Name	Base Type																																										
	S_EIPOutput	STRUCT																																										
8	<p>Enter <i>ControlFlag</i> in the <i>Name</i> Column.</p> <p>Enter <i>U_EIPFlag</i> in the <i>Base Type</i> Column.</p>	<table border="1" style="width: 100%; border-collapse: collapse;"> <thead> <tr> <th style="width: 10%;"></th> <th style="width: 40%;">Name</th> <th style="width: 30%;">Base Type</th> <th style="width: 10%;">Offset Type</th> <th style="width: 10%;">Offset Byte</th> <th style="width: 10%;">Offset Bit</th> </tr> </thead> <tbody> <tr> <td>▼</td> <td>S_EIPOutput</td> <td>STRUCT</td> <td>NJ</td> <td></td> <td></td> </tr> <tr style="border: 2px solid red;"> <td></td> <td>ControlFlag</td> <td>BOOL</td> <td></td> <td></td> <td></td> </tr> </tbody> </table> <p style="text-align: center;">↓</p> <table border="1" style="width: 100%; border-collapse: collapse;"> <thead> <tr> <th style="width: 10%;"></th> <th style="width: 40%;">Name</th> <th style="width: 30%;">Base Type</th> <th style="width: 10%;">Offset Type</th> <th style="width: 10%;">Offset Byte</th> <th style="width: 10%;">Offset Bit</th> </tr> </thead> <tbody> <tr> <td>▼</td> <td>S_EIPOutput</td> <td>STRUCT</td> <td>NJ</td> <td></td> <td></td> </tr> <tr> <td></td> <td>ControlFlag</td> <td style="border: 2px solid red;">U_EIPFlag</td> <td></td> <td></td> <td></td> </tr> </tbody> </table>		Name	Base Type	Offset Type	Offset Byte	Offset Bit	▼	S_EIPOutput	STRUCT	NJ				ControlFlag	BOOL					Name	Base Type	Offset Type	Offset Byte	Offset Bit	▼	S_EIPOutput	STRUCT	NJ				ControlFlag	U_EIPFlag									
	Name	Base Type	Offset Type	Offset Byte	Offset Bit																																							
▼	S_EIPOutput	STRUCT	NJ																																									
	ControlFlag	BOOL																																										
	Name	Base Type	Offset Type	Offset Byte	Offset Bit																																							
▼	S_EIPOutput	STRUCT	NJ																																									
	ControlFlag	U_EIPFlag																																										
9	<p>In the same way as steps 7 and 8, enter the following data in the new member columns.</p> <ul style="list-style-type: none"> • Name: <i>CommandCode</i> Base Type: <i>DWORD</i> • Name: <i>CommandParam1</i> Base Type: <i>DINT</i> • Name: <i>CommandParam2</i> Base Type: <i>DINT</i> • Name: <i>CommandParam3</i> Base Type: <i>DINT</i> <p>*The members are entered in order of the structures listed in 6.2. <i>Data Types for Tag Data Links</i>.</p>	<table border="1" style="width: 100%; border-collapse: collapse;"> <thead> <tr> <th style="width: 10%;"></th> <th style="width: 40%;">Name</th> <th style="width: 30%;">Base Type</th> <th style="width: 10%;">Offset Type</th> <th style="width: 10%;">Offset Byte</th> <th style="width: 10%;">Offset Bit</th> </tr> </thead> <tbody> <tr> <td>▼</td> <td>S_EIPOutput</td> <td>STRUCT</td> <td>NJ</td> <td></td> <td></td> </tr> <tr> <td></td> <td>ControlFlag</td> <td>U_EIPFlag</td> <td></td> <td></td> <td></td> </tr> <tr style="border: 2px solid red;"> <td></td> <td>CommandCode</td> <td>DWORD</td> <td></td> <td></td> <td></td> </tr> <tr style="border: 2px solid red;"> <td></td> <td>CommandParam1</td> <td>DINT</td> <td></td> <td></td> <td></td> </tr> <tr style="border: 2px solid red;"> <td></td> <td>CommandParam2</td> <td>DINT</td> <td></td> <td></td> <td></td> </tr> <tr style="border: 2px solid red;"> <td></td> <td>CommandParam3</td> <td>DINT</td> <td></td> <td></td> <td></td> </tr> </tbody> </table>		Name	Base Type	Offset Type	Offset Byte	Offset Bit	▼	S_EIPOutput	STRUCT	NJ				ControlFlag	U_EIPFlag					CommandCode	DWORD					CommandParam1	DINT					CommandParam2	DINT					CommandParam3	DINT			
	Name	Base Type	Offset Type	Offset Byte	Offset Bit																																							
▼	S_EIPOutput	STRUCT	NJ																																									
	ControlFlag	U_EIPFlag																																										
	CommandCode	DWORD																																										
	CommandParam1	DINT																																										
	CommandParam2	DINT																																										
	CommandParam3	DINT																																										

10 After entering, right-click and select **Create New Data Type** from the menu.

Name	Base Type	Offset Type	Offset Byte	Offset Bit
▼ S_EIPOutput	STRUCT	NJ		
ControlFlag	U_EIPFlag			
CommandCode	DWORD			
CommandParam1	DINT			
CommandParam2	DINT			
CommandParam3	DINT			

Create New Data Type
Create New Member

Enter *S_EIPInput* in the Name Column.

↓

Name	Base Type	Offset Type	Offset Byte	Offset Bit
▼ S_EIPOutput	STRUCT	NJ		
ControlFlag	U_EIPFlag			
CommandCode	DWORD			
CommandParam1	DINT			
CommandParam2	DINT			
CommandParam3	DINT			
S_EIPInput	STRUCT	NJ		

11 In the same way as steps 7 and 8, enter the following data in the new member columns.

- Name: *StatusFlag*
Base Type: *U_EIPFlag*
- Name: *CommandCodeEcho*
Base Type: *DWORD*
- Name: *ResponseCode*
Base Type: *DWORD*
- Name: *ResponseData*
Base Type: *DINT*
- Name: *OutputData*
Base Type: *DINT[8]*

Name	Base Type	Offset Type	Offset Byte	Offset Bit
▼ S_EIPOutput	STRUCT	NJ		
ControlFlag	U_EIPFlag			
CommandCode	DWORD			
CommandParam1	DINT			
CommandParam2	DINT			
CommandParam3	DINT			
▼ S_EIPInput	STRUCT	NJ		
StatusFlag	U_EIPFlag			
CommandCodeEcho	DWORD			
ResponseCode	DWORD			
ResponseData	DINT			
OutputData	ARRAY[0..7] OF DINT			

*The members are entered in order of the structures listed in 6.2. *Data Types for Tag Data Links*.

*After entering, the value changes to ARRAY[0..7] OF DINT as shown on the right.

12 Double-click **Global Variables** under **Programming - Data** in the Multiview Explorer.

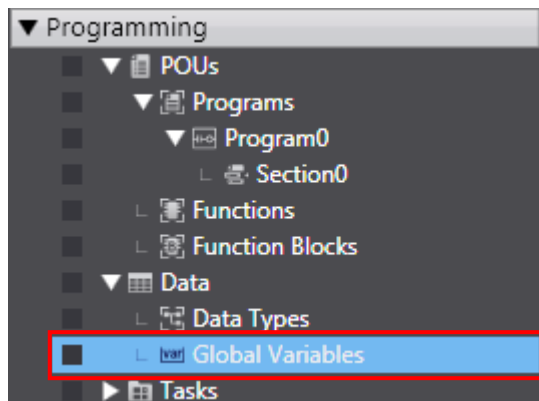

13 The Global Variables Tab Page is displayed in the Edit Pane.

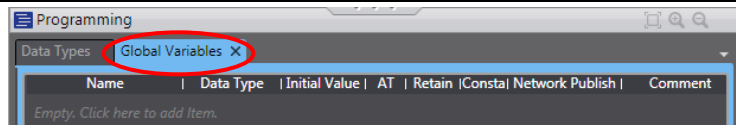

Click a column under the *Name* Column to enter a new variable.

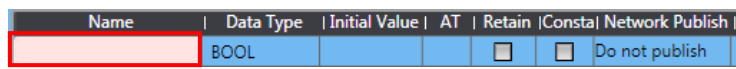

Enter *EIOutput* in the *Name* Column.

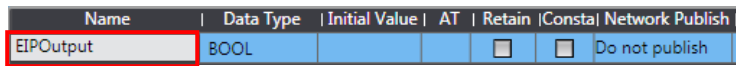

Enter *S_EIOutput* in the *Data Type* Column.

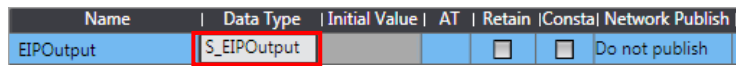

Select **Output** from the Network Publish Menu.

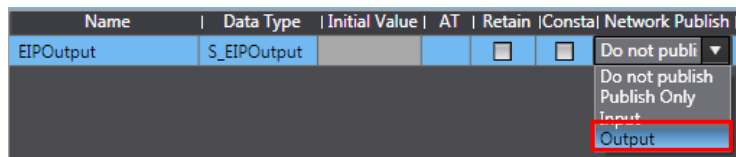

Check that Output is selected in the *Network Publish* Column.

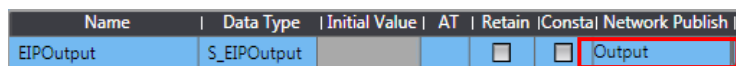

14 After entering, right-click and select **Create New** from the menu.

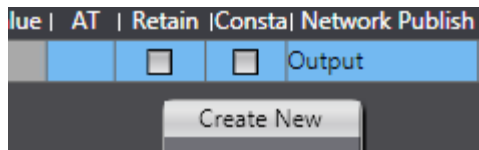

15 In the same way as steps 2 and 3, enter the following data in the new columns.

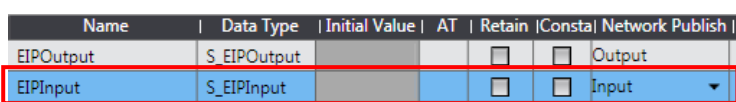

- Name: *EIInput*
- Data Type: *S_EIInput*
- Network Publish: *Input*

16 Double-click **Task Settings** under **Configurations and Setup** in the Multiview Explorer. The Task Settings Tab Page is displayed in the Edit Pane. Click **VAR**.

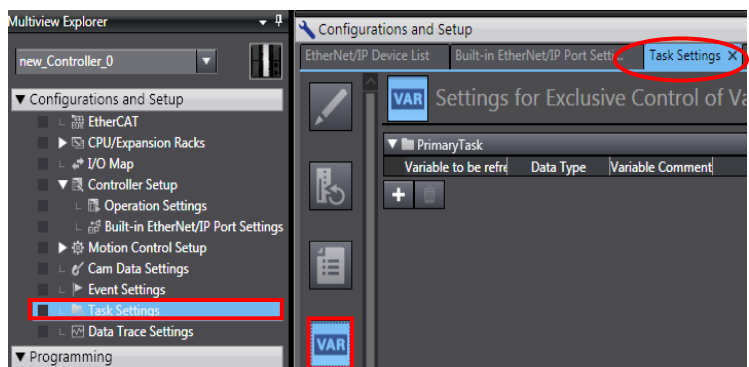

17 Click the + Button.

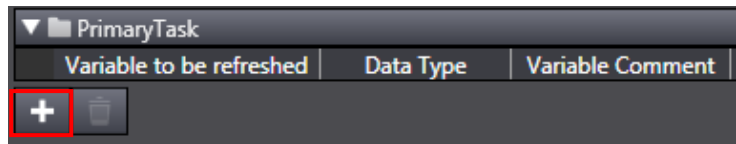

A new column is added.
Click the **Down Arrow** Button of the *Variable to be refreshed* Field (on the left side).

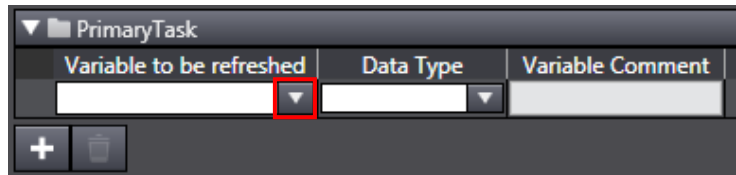

The variables set in this clause are displayed.
Select **EIOutput**.

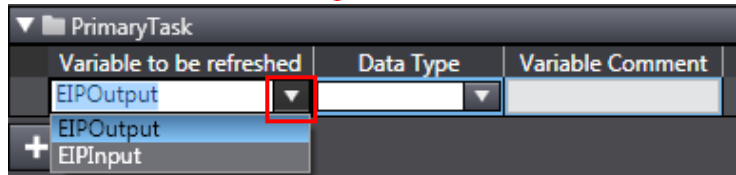

EIOutput is added.

*The data types are displayed automatically, so no need to be set.

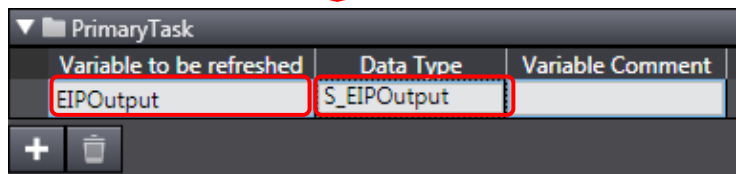

18 In the same way as step 17, add the all variables set in this clause to the *Variable to be refreshed* Field (on the left side).

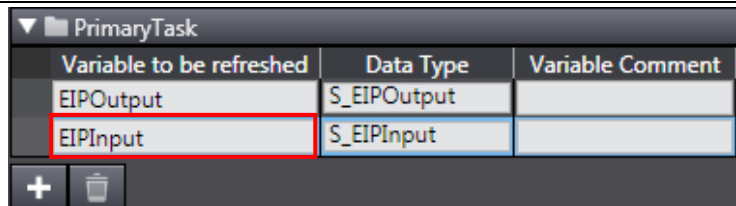

*The data types are displayed automatically, so no need to be set.

7.3.4. Tag Registration

Register the tags and the tag sets.

<p>1 Click the Tag Set Button in the Built-in EtherNet/IP Port Settings Connection Settings Tab Page. Select the Input Tab in Tag Sets.</p>													
<p>2 Right-click any open space in the Input Tab Page and select Create New Tag Set from the menu.</p>													
<p>3 A new name in the <i>Tag Set Name</i> Column can be entered. Select the column newly added. Enter <i>EIP002_IN</i>.</p>													
<p>4 While the EIP002_IN is being selected, right-click and select Create New Tag from the menu.</p> <p>A new tag name can be entered in the EIP002_IN. Select the column newly added.</p> <p>Set the global variable of IN No.1 listed in 6.4. <i>Tag Sets</i> as a tag.</p> <p>*When the first character of the set variable is entered, the list that starts with the character entered is displayed.</p>	<table border="1" data-bbox="695 1888 1433 1995"> <thead> <tr> <th>Tag Set Name</th> <th>Bit Selection</th> <th>Size (Byte)</th> <th>Size (Bit)</th> </tr> </thead> <tbody> <tr> <td>EIP002_IN</td> <td><input type="checkbox"/></td> <td>48</td> <td></td> </tr> <tr> <td>EIPInput</td> <td><input type="checkbox"/></td> <td>48</td> <td>0</td> </tr> </tbody> </table>	Tag Set Name	Bit Selection	Size (Byte)	Size (Bit)	EIP002_IN	<input type="checkbox"/>	48		EIPInput	<input type="checkbox"/>	48	0
Tag Set Name	Bit Selection	Size (Byte)	Size (Bit)										
EIP002_IN	<input type="checkbox"/>	48											
EIPInput	<input type="checkbox"/>	48	0										

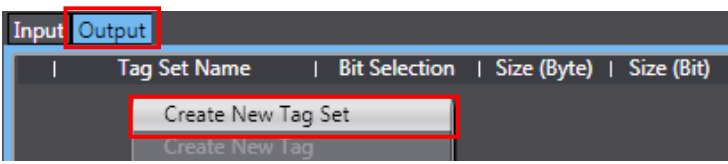
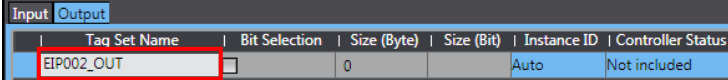
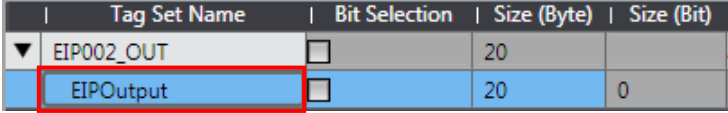
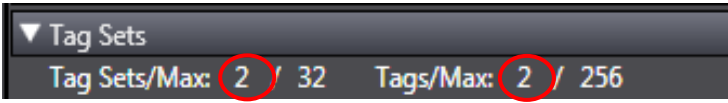
<p>5</p>	<p>Select Output Tab. Right-click any open space in the Output Tab Page and select Create New Tag Set from the menu.</p>	
<p>6</p>	<p>A new name in the <i>Tag Set Name</i> Column can be entered. In the same way as step 3, enter <i>EIP002_OUT</i>.</p>	
<p>7</p>	<p>In the same way as step 4, set the global variable of OUT No.1 listed in 6.4. <i>Tag Sets</i> as a tag,</p>	
<p>8</p>	<p>Check that Tag Sets shows 2 and that the value of Tags shows the same as the number of the global variables set.</p>	

7.3.5. Setting the Connections

Set the target variable (that receives the open request) and the originator variable (that requests opening), and set the connections (tag data link table).

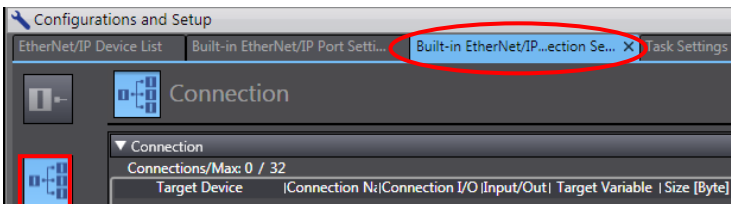
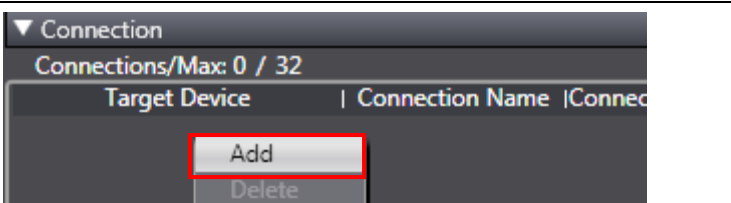
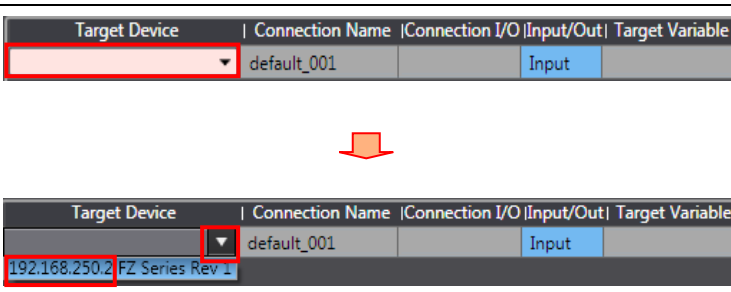
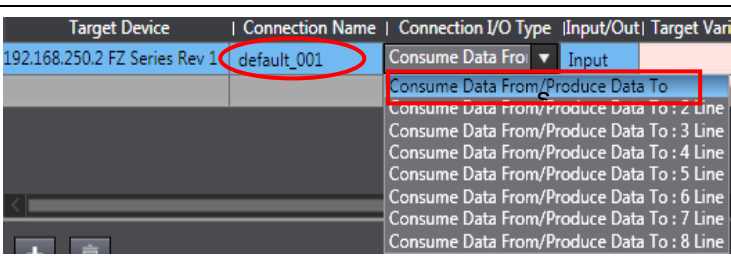
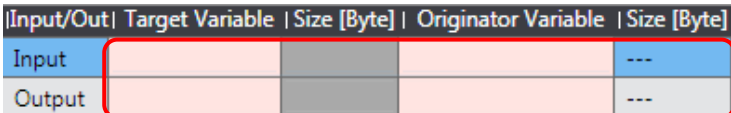
<p>1 Click the Connection Button in the Built-in EtherNet/IP Port Settings Connection Settings Tab Page.</p>	
<p>2 Right-click any open space in Connection and select Add from the menu.</p>	
<p>3 A new connection can be entered. Select the column newly added.</p> <p>Select 192.168.250.2 from the pull-down list under the <i>Target Device</i> Column.</p>	
<p>4 The default_001 is created in the <i>Connection Name</i> Column. Select Consume Data From/Produce Data To from the Connection I/O Type pull-down list.</p>	
<p>5 The target variable and the originator variable can be set.</p>	

6 Click a column in *Target Variable* of Input.

Input/Out	Target Variable	Size [Byte]	Originator Variable	Size [Byte]
Input				---
Output				---

When you press **Ctrl + Space** on the keyboard, an applicable instance number appears.

Input/Out	Target Variable	Size [Byte]	Originator Variable	Size [Byte]
Input				---
Output				---

*The instance number also appears even when the first character of the instance number "1" is entered.

Select the instance number.

Input/Out	Target Variable	Size [Byte]	Originator Variable	Size [Byte]
Input	101	48		---
Output				---

In the same way, set the target variable of output.

Input/Out	Target Variable	Size [Byte]	Originator Variable	Size [Byte]
Input	101	48		---
Output	100	20		---

7 Click a column in *Originator Variable* of Input.

The pull-down list is displayed.

Select the tag set name to use.

Input/Out	Target Variable	Size [Byte]	Originator Variable	Size [Byte]
Input	101	48		---
Output	100	20	EIP002_IN	---

In the same way, set the originator variable of output.

Input/Out	Target Variable	Size [Byte]	Originator Variable	Size [Byte]
Input	101	48	EIP002_IN	48
Output	100	20	EIP002_OUT	20

8 Select **Point to Point connection** from the Connection Type pull-down list.

Input/Out	Target Variable	Size [Byte]	Originator Variable	Size [Byte]	Connection Type
Input	101	48	EIP002_IN	48	Multi-cast connection
Output	100	20	EIP002_OUT	20	Multi-cast connection

*On FZ5 Sensor Controller, set the connection type to **Point to Point** connection for both input and output.

Input/Out	Target Variable	Size [Byte]	Originator Variable	Size [Byte]	Connection Type
Input	101	48	EIP002_IN	48	Point to Point connection
Output	100	20	EIP002_OUT	20	Point to Point connection

9 Set RPI[ms] and the timeout value as required.

Originator Variable	Size [Byte]	Connection Type	RPI [ms]	Timeout V
EIP002_IN	48	Point to Point connection	50.0	RPI x 4
EIP002_OUT	20	Point to Point connection		

*In this document, the default values are used for these settings.



Precautions for Correct Use

Set RPI to 4ms or longer for FZ5 Sensor Controller.



Precautions for Correct Use

When the measurement interval is short, the measurement processing load is high, or command processing for operations such as scene group changing is time-consuming, FZ5 Sensor Controller prioritizes measurement and control processing over communication processing. As a result, communication between an external device and FZ5 Sensor Controller may be temporarily interrupted, and a communication error may occur.

In this case, set the timeout value as shown below.

Packet Interval (RPI value) × Timeout Value > FZ5 Sensor Controller's Processing Time

For details on the timeout value of FZ5 Sensor Controller, refer to *EtherNet/IP*

Communications in *Communicating with EtherNet/IP* in *Section 2. Methods for Connecting and Communicating with External Devices* of the *Vision Sensor FH/FZ5 Series Vision System User's Manual for Communications Settings* (Cat. No. Z342).

10 Check that Connections shows
1.

▼ Connection
Connections/Max: 1 / 32

7.3.6. Transferring the Project Data

Connect online and transfer the connection settings and the project data to Controller.



⚠ **WARNING**

When you transfer a user program, configuration data, setup data, device variables, or values in memory used for CJ-series Units from Sysmac Studio, the devices or machines may perform unexpected operation regardless of the operating mode of CPU Unit.

Always confirm safety at the destination node before you transfer the project data.

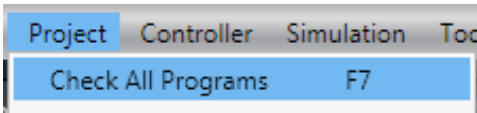
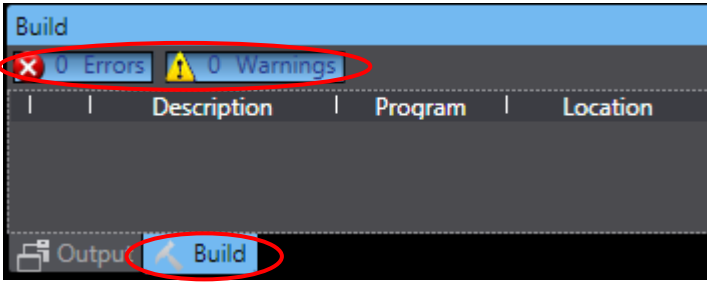
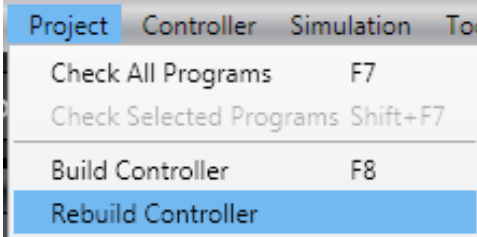
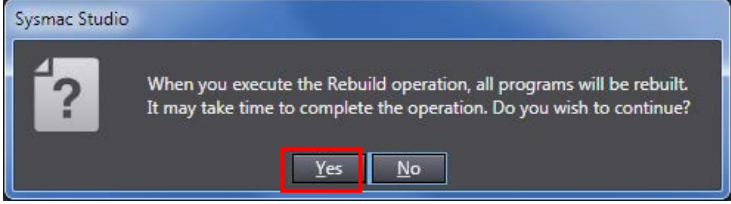
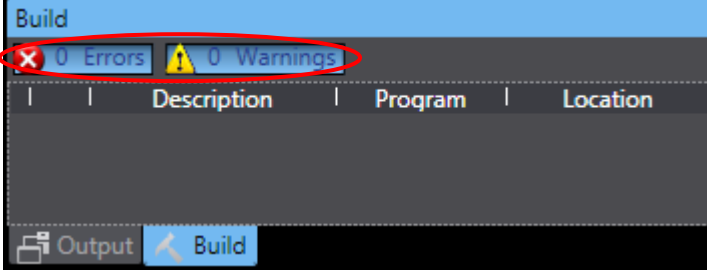

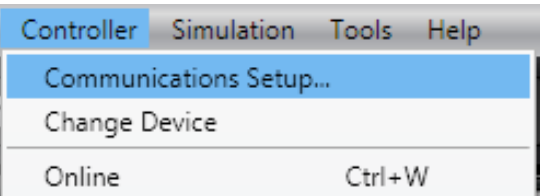
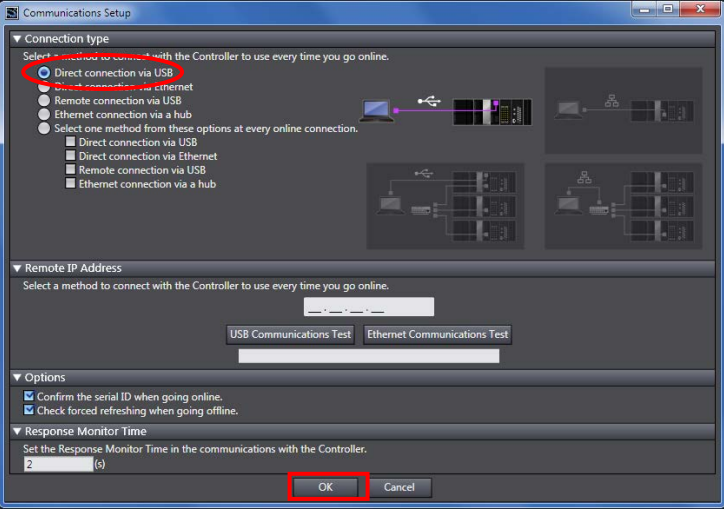
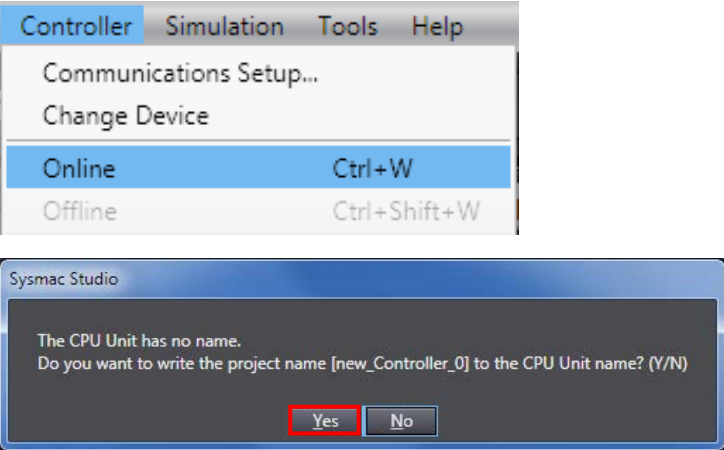
- | | | |
|---|---|--|
| 1 | Turn ON the power supply to Controller and Switching hub. | |
| 2 | Select Check All Programs from the Project Menu. |  |
| 3 | The Build Tab Page is displayed.
Check that "0 Errors" and "0 Warnings" are displayed. |  |
| 4 | Select Rebuild Controller from the Project Menu. |  |
| 5 | A confirmation dialog box is displayed. Check the contents and click Yes . |  |
| 6 | Check that "0 Errors" and "0 Warnings" are displayed in the Build Tab Page. |  |

- | | | |
|----|--|--|
| 7 | <p>Select Communications Setup from the Controller Menu.</p> |  |
| 8 | <p>The Communications Setup Dialog Box is displayed. Check that the <i>Direct connection via USB</i> Option is selected for the Connection type. Click OK.</p> |  |
| 9 | <p>Select Online from the Controller Menu. A confirmation dialog box is displayed. Check the contents and click Yes.</p> <p>*The displayed dialog depends on the status of Controller used. Check the contents and click OK or Yes to proceed with the processing.</p> |  |
| 10 | <p>When an online connection is established, a yellow bar is displayed on the top of the Edit Pane.</p> |  |



Additional Information

For details on online connections to Controller, refer to *Section 6. Online Connections to a Controller* of the *Sysmac Studio Version 1 Operation Manual* (Cat. No. W504).

11 Select **Synchronization** from the Controller Menu.

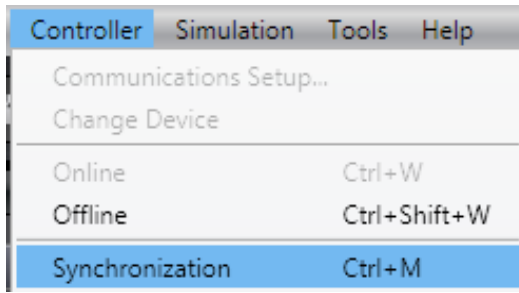

12 The Synchronization Dialog Box is displayed.

Check that the data to transfer (NJ501 in the right dialog box) is selected.

Uncheck *Do not transfer the EtherNet/IP connection settings (built-in port and Unit)*.

Click **Transfer To Controller**.

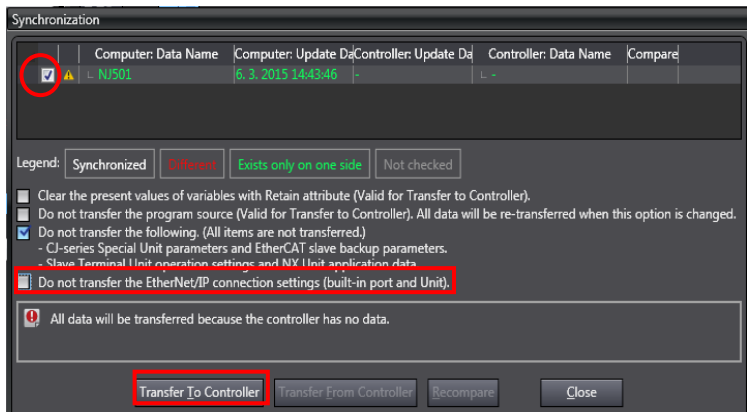

*After executing Transfer To Controller, the Sysmac Studio data is transferred to Controller and the data is compared.

13 A confirmation dialog box on the right is displayed. Check that there is no problem and click **Yes**.

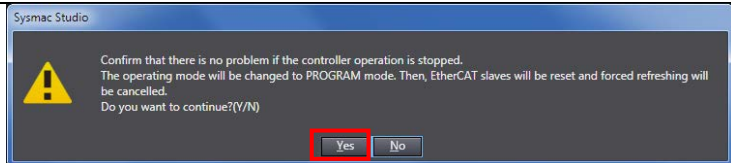

A screen stating "Synchronizing" is displayed.



A confirmation dialog box on the right is displayed. Check that there is no problem and click **No**.

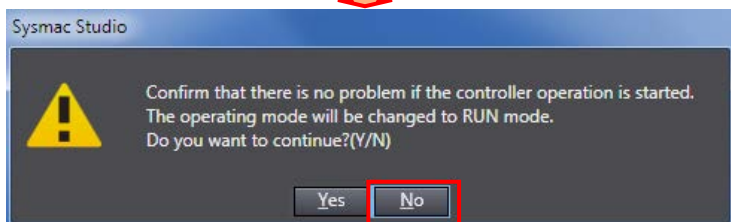

*Do not return to RUN mode.

14 Check that the synchronized data is displayed with the color specified by "Synchronized", and that a message is displayed stating "The synchronization process successfully finished". If there is no problem, click **Close**.

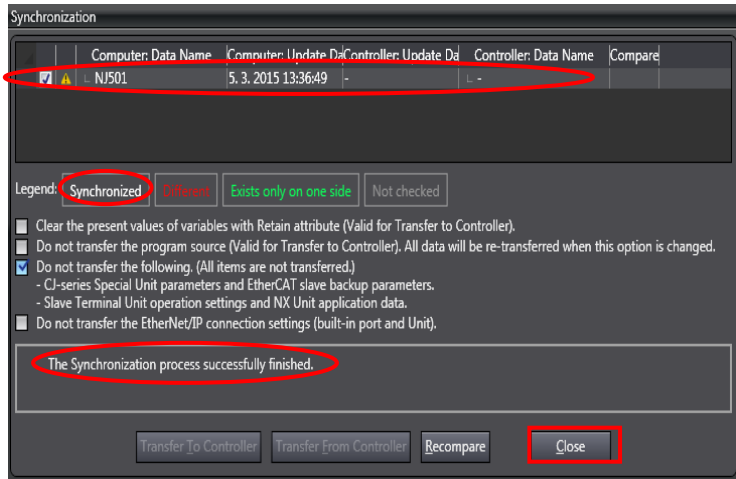

*A message stating "The synchronization process successfully finished" is displayed if the Sysmac Studio project data coincides with the Controller data.

*If the synchronization fails, check the wiring and repeat from step 1.

15 Check that ERR/ALM indicator in Controller Status Pane changes to green color and that PROGRAM mode is displayed.

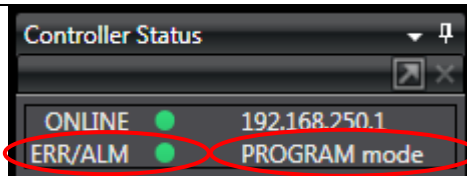

Precautions for Correct Use

If changing the connection settings (tag data link table) after performing the synchronization, the connection settings (tag data link table) are not transferred even when performing the synchronization again.

When transferring, click **Transfer to Controller** in the Built-in EtherNet/IP Port Settings Connection Settings Tab Page to transfer.

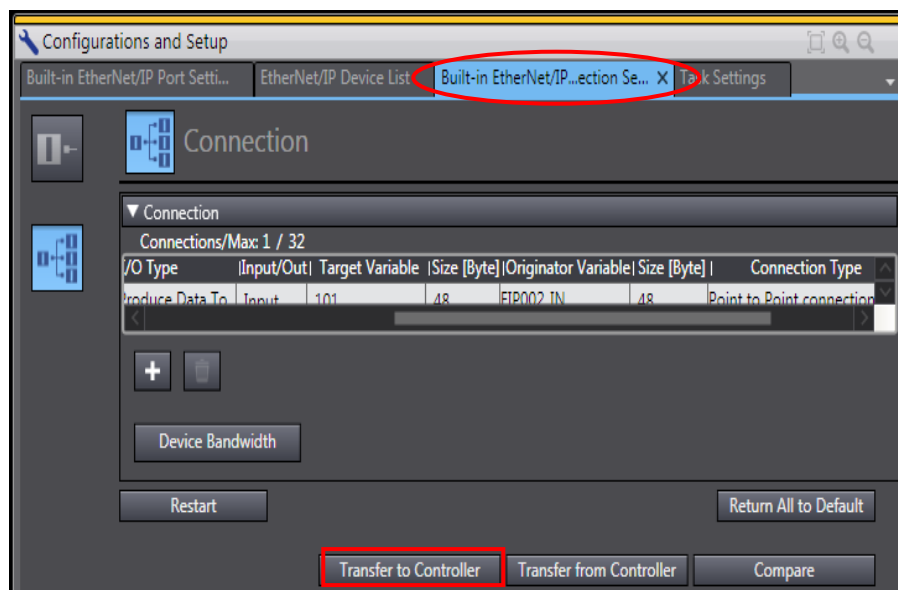

7.4. Checking the EtherNet/IP Communications

Check that the EtherNet/IP tag data links are operated normally.

7.4.1. Checking the Connection Status

Check the connection status of EtherNet/IP.

<p>1</p>	<p>Check that the tag data links are performed normally by checking the LED indicators on Controller.</p> <p>The LED indicators in normal status are as follows:</p> <ul style="list-style-type: none"> NET RUN: Green lit NET ERR: Not lit LINK/ACT: Yellow flashing (Flashing while packets are being sent and received) 										
<p>2</p>	<p>Select the EtherNet/IP Device List Tab.</p>	<table border="1"> <thead> <tr> <th>Node Address</th> <th>Device</th> </tr> </thead> <tbody> <tr> <td>192.168.250.1</td> <td>Built-in EtherNet/IP Port Settings</td> </tr> </tbody> </table>	Node Address	Device	192.168.250.1	Built-in EtherNet/IP Port Settings					
Node Address	Device										
192.168.250.1	Built-in EtherNet/IP Port Settings										
<p>3</p>	<p>While the Built-in EtherNet/IP Port Settings is being selected, right-click and select Monitor from the menu.</p>										
<p>4</p>	<p>The Built-in EtherNet/IP Port Settings Connection Monitor Tab Page is displayed.</p>										
<p>5</p>	<p>Select the Connection Status Tab. Check that a blue circle is displayed next to the applicable connection listed in the <i>Connection Name</i> Column. Check that the Status is 00:0000.</p>	<table border="1"> <thead> <tr> <th>Connection Name</th> <th>Type</th> <th>Status</th> </tr> </thead> <tbody> <tr> <td>192.168.250.2 default_001</td> <td>Out/In</td> <td>00:0000</td> </tr> </tbody> </table>	Connection Name	Type	Status	192.168.250.2 default_001	Out/In	00:0000			
Connection Name	Type	Status									
192.168.250.2 default_001	Out/In	00:0000									
<p>6</p>	<p>Select the Tag Status Tab. Check that all tags in the <i>Tag Name</i> Column are displayed and that green circles are displayed next to them. Check that the statuses for all tags are normally resolved.</p>	<table border="1"> <thead> <tr> <th>Tag Name</th> <th>Input/Output</th> <th>Status</th> </tr> </thead> <tbody> <tr> <td>EIPInput</td> <td>Input</td> <td>Normally resolved</td> </tr> <tr> <td>EIPOutput</td> <td>Output</td> <td>Normally resolved</td> </tr> </tbody> </table>	Tag Name	Input/Output	Status	EIPInput	Input	Normally resolved	EIPOutput	Output	Normally resolved
Tag Name	Input/Output	Status									
EIPInput	Input	Normally resolved									
EIPOutput	Output	Normally resolved									

7.4.2. Checking the Sent and Received Data

Check that the correct data are sent and received.

Caution

If you change the values of variables on a Watch Tab Page in the online state, the connected devices to the output unit may operate regardless of the operating mode of CPU Unit.

Sufficiently confirm safety before you change the values of variables on a Watch Tab Page when Sysmac Studio is online with CPU Unit.

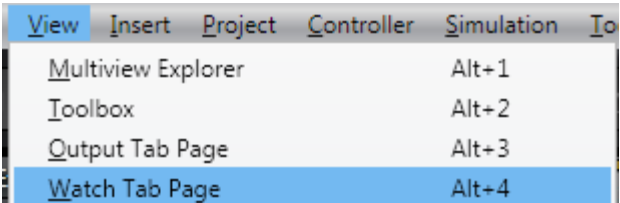
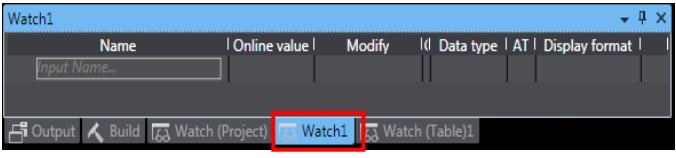
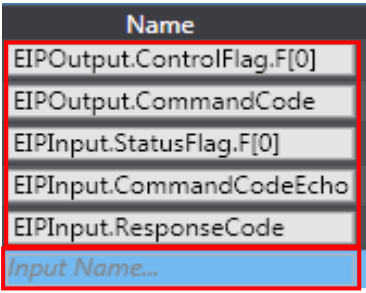
1	Select Watch Tab Page from the View Menu.																																																	
2	Select the Watch1 Tab.																																																	
3	Click <i>Input Name</i> , and enter the name of the variables for monitoring. When setting a new variable name, enter the following variable names. <i>EIOutput.ControlFlag.F[0]</i> <i>EIOutput.CommandCode</i> <i>EIInput.StatusFlag.F[0]</i> <i>EIInput.CommandCodeEcho</i> <i>EIInput.ResponseCode</i>																																																	
4	Enter <i>00101010</i> in the <i>Modify</i> Column of <i>EIOutput.CommandCode</i> . (CommandCode [00101010]: Measurement) By pressing Enter , the value is set and the online value of <i>EIOutput.CommandCode</i> changes to 00101010.	<table border="1" style="width: 100%; border-collapse: collapse; margin-bottom: 10px;"> <thead> <tr> <th>Name</th> <th>Online value</th> <th>Modify</th> <th>Data type</th> </tr> </thead> <tbody> <tr> <td>EIOutput.ControlFlag.F[0]</td> <td>False</td> <td>TRUE FALSE</td> <td>BOOL</td> </tr> <tr> <td>EIOutput.CommandCode</td> <td>0000 0000</td> <td>00101010</td> <td>DWORD</td> </tr> <tr> <td>EIInput.StatusFlag.F[0]</td> <td>False</td> <td>TRUE FALSE</td> <td>BOOL</td> </tr> <tr> <td>EIInput.CommandCodeEcho</td> <td>0000 0000</td> <td></td> <td>DWORD</td> </tr> <tr> <td>EIInput.ResponseCode</td> <td>0000 0000</td> <td></td> <td>DWORD</td> </tr> </tbody> </table> <div style="text-align: center; margin-bottom: 10px;"> </div> <table border="1" style="width: 100%; border-collapse: collapse;"> <thead> <tr> <th>Name</th> <th>Online value</th> <th>Modify</th> <th>Data type</th> </tr> </thead> <tbody> <tr> <td>EIOutput.ControlFlag.F[0]</td> <td>False</td> <td>TRUE FALSE</td> <td>BOOL</td> </tr> <tr> <td>EIOutput.CommandCode</td> <td>0010 1010</td> <td>00101010</td> <td>DWORD</td> </tr> <tr> <td>EIInput.StatusFlag.F[0]</td> <td>False</td> <td>TRUE FALSE</td> <td>BOOL</td> </tr> <tr> <td>EIInput.CommandCodeEcho</td> <td>0000 0000</td> <td></td> <td>DWORD</td> </tr> <tr> <td>EIInput.ResponseCode</td> <td>0000 0000</td> <td></td> <td>DWORD</td> </tr> </tbody> </table>	Name	Online value	Modify	Data type	EIOutput.ControlFlag.F[0]	False	TRUE FALSE	BOOL	EIOutput.CommandCode	0000 0000	00101010	DWORD	EIInput.StatusFlag.F[0]	False	TRUE FALSE	BOOL	EIInput.CommandCodeEcho	0000 0000		DWORD	EIInput.ResponseCode	0000 0000		DWORD	Name	Online value	Modify	Data type	EIOutput.ControlFlag.F[0]	False	TRUE FALSE	BOOL	EIOutput.CommandCode	0010 1010	00101010	DWORD	EIInput.StatusFlag.F[0]	False	TRUE FALSE	BOOL	EIInput.CommandCodeEcho	0000 0000		DWORD	EIInput.ResponseCode	0000 0000		DWORD
Name	Online value	Modify	Data type																																															
EIOutput.ControlFlag.F[0]	False	TRUE FALSE	BOOL																																															
EIOutput.CommandCode	0000 0000	00101010	DWORD																																															
EIInput.StatusFlag.F[0]	False	TRUE FALSE	BOOL																																															
EIInput.CommandCodeEcho	0000 0000		DWORD																																															
EIInput.ResponseCode	0000 0000		DWORD																																															
Name	Online value	Modify	Data type																																															
EIOutput.ControlFlag.F[0]	False	TRUE FALSE	BOOL																																															
EIOutput.CommandCode	0010 1010	00101010	DWORD																																															
EIInput.StatusFlag.F[0]	False	TRUE FALSE	BOOL																																															
EIInput.CommandCodeEcho	0000 0000		DWORD																																															
EIInput.ResponseCode	0000 0000		DWORD																																															

5 Click **TRUE** in the *Modify* Column of *EIOutput.ControlFlag.F[0]*.

Name	Online value	Modify	Data type
EIOutput.ControlFlag.F[0]	False	TRUE FALSE	BOOL
EIOutput.CommandCode	0010 1010	00101010	DWORD
EIInput.StatusFlag.F[0]	False	TRUE FALSE	BOOL
EIInput.CommandCodeEcho	0000 0000		DWORD
EIInput.ResponseCode	0000 0000		DWORD

The online value changes to True.
(EIOutput.ControlFlag.F[0]:
Command Execution Bit (EXE))

Name	Online value	Modify	Data type
EIOutput.ControlFlag.F[0]	True	TRUE FALSE	BOOL
EIOutput.CommandCode	0010 1010	00101010	DWORD
EIInput.StatusFlag.F[0]	True	TRUE FALSE	BOOL
EIInput.CommandCodeEcho	0010 1010		DWORD
EIInput.ResponseCode	0000 0000		DWORD

6 After completing the measurement, OK is displayed on Monitor.



7 The online values of *EIInput.StatusFlag.F[0]*, *EIInput.CommandCodeEcho*, and *EIInput.ResponseCode* are as follows:

- *EIInput.StatusFlag.F[0]*: True (Command completed)
- *EIInput.CommandCodeEcho*: 00101010 (The sent command code is returned.)
- *EIInput.ResponseCode*: 0000 0000 (The execution result of the command 0000 0000: OK or FFFF FFFF: NG is reflected.)

Name	Online value	Modify	Data type
EIOutput.ControlFlag.F[0]	True	TRUE FALSE	BOOL
EIOutput.CommandCode	0010 1010	00101010	DWORD
EIInput.StatusFlag.F[0]	True	TRUE FALSE	BOOL
EIInput.CommandCodeEcho	0010 1010		DWORD
EIInput.ResponseCode	0000 0000		DWORD

8. Initialization Method

This document provides the explanation of the setting procedure based on the factory default setting.

Some settings may not be applicable as described in this document unless you use the devices with the factory default setting.

8.1. Initializing Controller

To initialize the settings of Controller, it is necessary to initialize CPU Unit.

Change Controller to PROGRAM mode before the initialization. Select **Clear All Memory** from the Controller Menu of Sysmac Studio. The Clear All Memory Dialog Box is displayed. Check the contents and click **OK**.

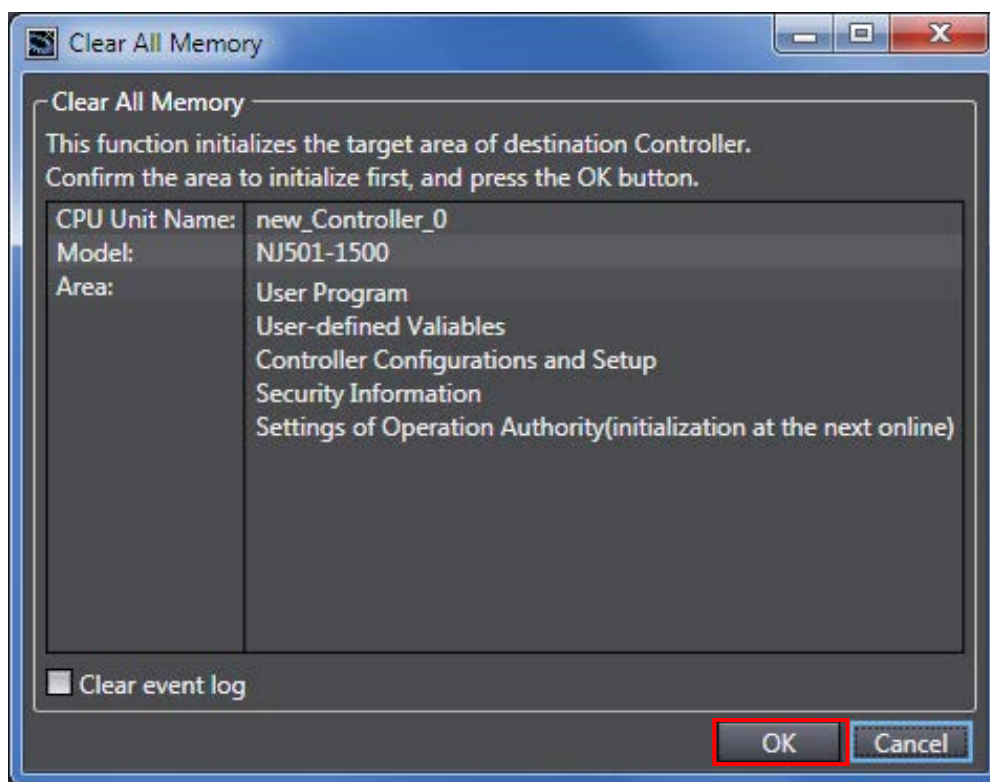

8.2. Initializing FZ5 Sensor Controller

For information on how to initialize FZ5 Sensor Controller, refer to *Initializing Controller* in *Section 1. Before Operation of the Vision Sensor FH/FZ5 Series Vision System User's Manual* (Cat. No. Z340).

9. Appendix Procedure Using the Project File

This section describes the procedure in which you use the following project file. The project file includes the contents that are set in 7.3. *Setting up Controller*. Obtain the latest project file from OMRON.

Name	File name	Version
Sysmac Studio compact project file (Extension: csm2)	OMRON_FZ5_EIP_EV200.csm2	Ver.2.00

9.1. Work Flow

Take the following steps to make the tag data link settings for EtherNet/IP using the project file.

Except 9.2.1. *Importing the Project File* enclosed in red, refer to each appropriate clause or sub-clause for further information.

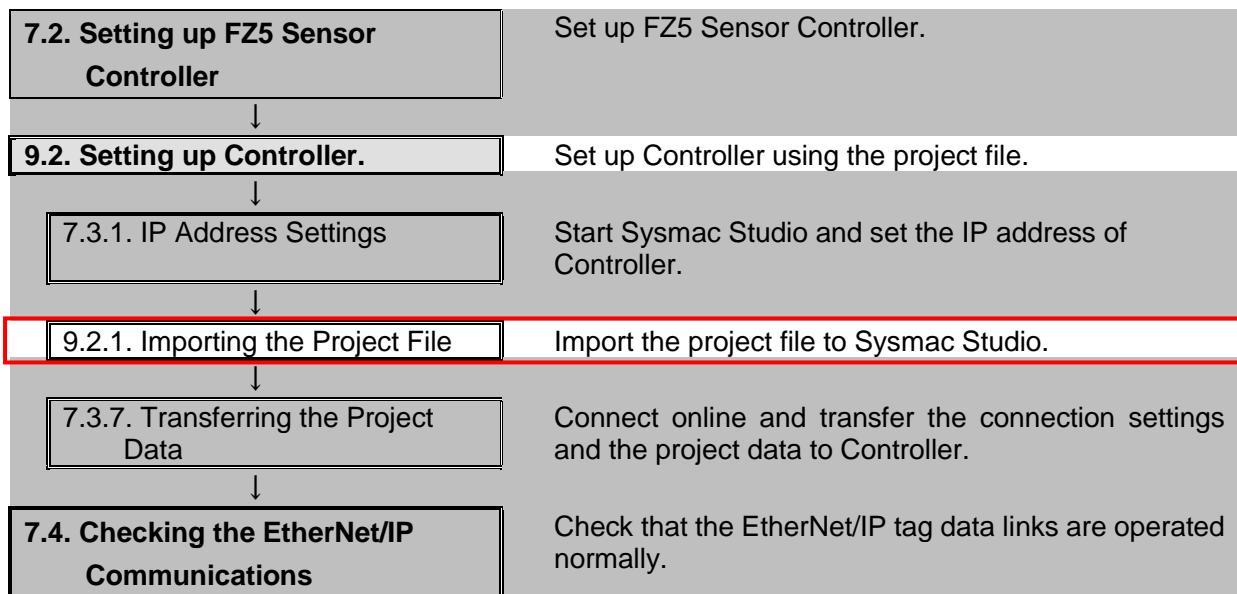

9.2. Setting up Controller

Set up Controller using the project file.

9.2.1. Importing the Project File

Import the project file to Sysmac Studio.

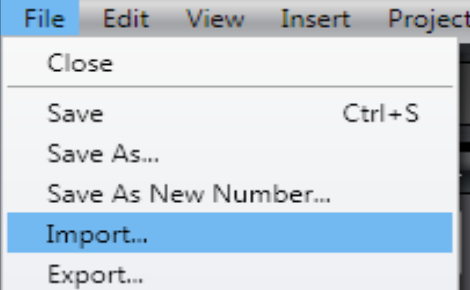
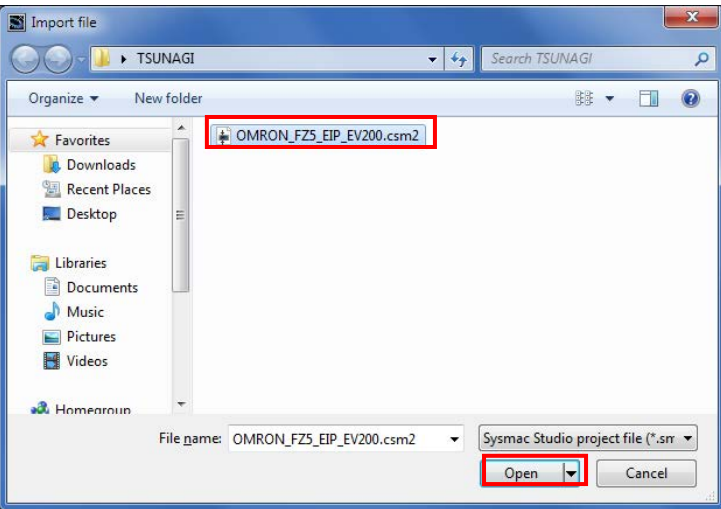
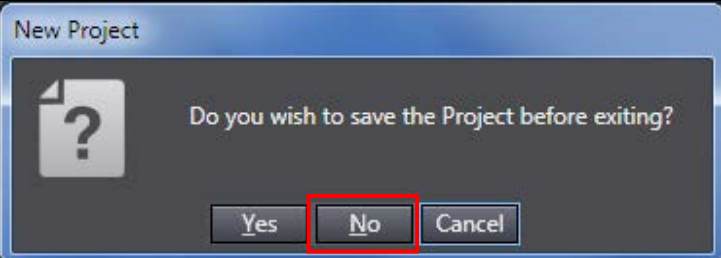
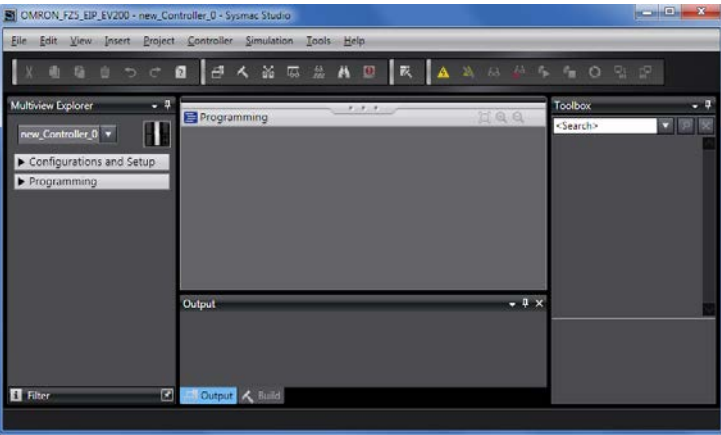
<p>1 Select Import from the File Menu.</p>	
<p>2 The Import file Dialog Box is displayed. Select <i>OMRON_FZ5_EIP_EV200.csm2</i> (project file) and click Open. *Obtain the project file from OMRON.</p>	
<p>3 The New Project Dialog Box is displayed. Check the contents and click No.</p>	
<p>4 The OMRON_FZ5_EIP_EV200 project is displayed. *If an error message is displayed stating "Failed to Load Descendants", change the version of Sysmac Studio to the version specified in 5.2. <i>Device Configuration</i> or higher version.</p>	

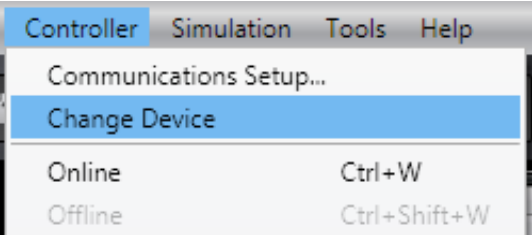
- | | | |
|----------|--|--|
| <p>5</p> | <p>Select Change Device from the Controller Menu.</p> |  <p>A screenshot of the software's menu bar. The 'Controller' menu is open, showing options: 'Communications Setup...', 'Change Device' (highlighted in blue), 'Online' (with keyboard shortcut Ctrl+W), and 'Offline' (with keyboard shortcut Ctrl+Shift+W).</p> |
| <p>6</p> | <p>The Change Device Dialog Box is displayed.
Check that the <i>Device</i> and the <i>Version</i> Fields are set as shown on the right.

Click Cancel.

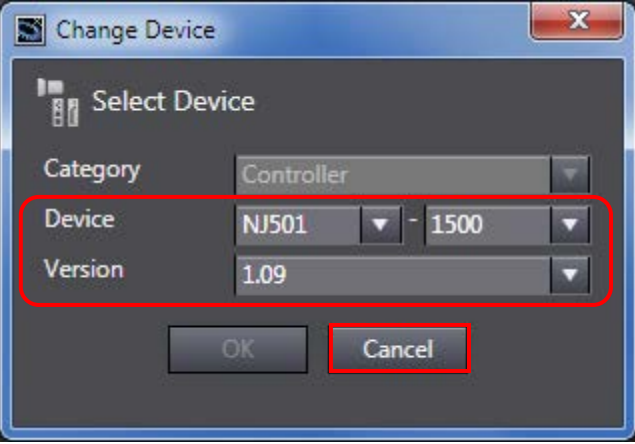
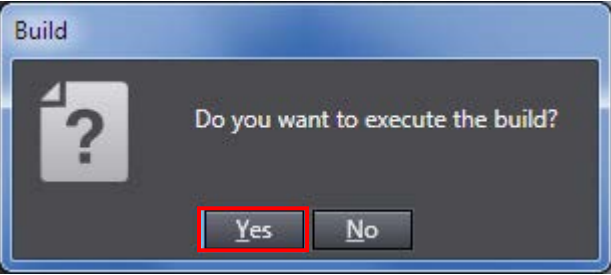
*If the settings are different, select the setting items from the pull-down list and click OK.</p> |  <p>A screenshot of the 'Change Device' dialog box. It has a title bar with a close button. The main area is titled 'Select Device' and contains three fields: 'Category' (set to 'Controller'), 'Device' (set to 'NJ501 - 1500'), and 'Version' (set to '1.09'). The 'Device' and 'Version' fields are enclosed in a red rectangular box. At the bottom, there are 'OK' and 'Cancel' buttons, with the 'Cancel' button also highlighted with a red box.</p> |
| <p>7</p> | <p>If you changed the settings in step 6, the Build Dialog Box is displayed. Check the contents and click Yes.</p> |  <p>A screenshot of the 'Build' dialog box. It features a question mark icon on the left and the text 'Do you want to execute the build?' on the right. At the bottom, there are 'Yes' and 'No' buttons, with the 'Yes' button highlighted by a red box.</p> |

10. Revision History

Revision code	Date of revision	Revision reason and revision page
01	December 20, 2013	First edition
02	April 22, 2015	Revisions due to upgraded versions of Controller and Sysmac Studio. The procedures for EtherNet/IP connection setting changed to that by Sysmac Studio. Screens changed due to upgraded version of FZ5 Sensor Controller. Point to Point connection set for input and output. Handshaking set for output control confirmed.

OMRON Corporation Industrial Automation Company

Tokyo, JAPAN

Contact: www.ia.omron.com

Regional Headquarters

OMRON EUROPE B.V.

Wegalaan 67-69, 2132 JD Hoofddorp
The Netherlands
Tel: (31)2356-81-300/Fax: (31)2356-81-388

OMRON ELECTRONICS LLC

2895 Greenspoint Parkway, Suite 200
Hoffman Estates, IL 60169 U.S.A
Tel: (1) 847-843-7900/Fax: (1) 847-843-7787

OMRON ASIA PACIFIC PTE. LTD.

No. 438A Alexandra Road # 05-05/08 (Lobby 2),
Alexandra Technopark,
Singapore 119967
Tel: (65) 6835-3011/Fax: (65) 6835-2711

OMRON (CHINA) CO., LTD.

Room 2211, Bank of China Tower,
200 Yin Cheng Zhong Road,
PuDong New Area, Shanghai, 200120, China
Tel: (86) 21-5037-2222/Fax: (86) 21-5037-2200

Authorized Distributor:

© OMRON Corporation 2015 All Rights Reserved.
In the interest of product improvement,
specifications are subject to change without notice.

Cat. No. P589-E1-02

0415- (1213)