



Machine Automation Controller NJ-series

EtherCAT[®] Connection Guide

OMRON Corporation

Vision System
(FH-series)

Network
Connection
Guide

About Intellectual Property Rights and Trademarks

Microsoft product screen shots reprinted with permission from Microsoft Corporation.

Windows is a registered trademark of Microsoft Corporation in the USA and other countries.

Sysmac is a trademark or registered trademark of OMRON Corporation in Japan and other countries for OMRON factory automation products.

EtherCAT_R is registered trademark and patented technology, licensed by Beckhoff Automation GmbH, Germany.

Company names and product names in this document are the trademarks or registered trademarks of their respective companies.

Table of Contents

1. Related Manuals	1
2. Terms and Definitions	2
3. Precautions	3
4. Overview	4
5. Applicable Devices and Device Configuration	5
5.1. Applicable Devices	5
5.2. Device Configuration	6
6. EtherCAT Settings	8
6.1. EtherCAT Communications Parameter Settings	8
6.2. Allocation for PDO Communications	8
7. EtherCAT Connection Procedure	10
7.1. Work Flow	10
7.2. Setting Up the FH Sensor Controller	11
7.3. Setting Up the Controller	16
7.4. Checking the EtherCAT Communications	26
8. Initialization Method	30
8.1. Initializing the Controller	30
8.2. Initializing the FH Sensor Controller	30
9. Revision History	31

1. Related Manuals

The table below lists the manuals related to this document.

To ensure system safety, make sure to always read and heed the information provided in all Safety Precautions, Precautions for Safe Use, and Precaution for Correct Use of manuals for each device which is used in the system.

Cat. No.	Model	Manual name
W500	NJ501-□□□□ NJ301-□□□□	NJ-series CPU Unit Hardware User's Manual
W501	NJ501-□□□□ NJ301-□□□□	NJ-series CPU Unit Software User's Manual
W505	NJ501-□□□□ NJ301-□□□□	NJ-series CPU Unit Built-in EtherCAT _R Port User's Manual
W504	SYSMAC-SE2□□□□	Sysmac Studio Version 1 Operation Manual
2285550-0	FH-1□□□/3□□□	Image Processing System Instruction Sheet
Z340	FH-1□□□/3□□□	Vision Sensor FH/FZ5 Series Vision System User's Manual
Z341	FH-1□□□/3□□□	Vision Sensor FH/FZ5 Series Vision System Processing Item Function Reference Manual
Z342	FH-1□□□/3□□□	Vision Sensor FH/FZ5 Series Vision System User's Manual (Communications Settings)
Z343	FH-1□□□/3□□□	Vision Sensor FH/FZ5 Series Vision System Operation Manual for Sysmac Studio

2. Terms and Definitions

Term	Explanation and Definition
PDO communications (Communications using Process Data Objects)	<p>This method is used for cyclic data exchange between the master unit and the slave units.</p> <p>PDO data (i.e., I/O data that is mapped to PDOs) that is allocated in advance is refreshed periodically each EtherCAT process data communications cycle (i.e., the period of primary periodic task).</p> <p>The NJ-series Machine Automation Controller uses the PDO communications for commands to refresh I/O data in a fixed control period, including I/O data for EtherCAT Slave Units, and the position control data for the Servo motors.</p> <p>It is accessed from the NJ-series Machine Automation Controller in the following ways:</p> <ul style="list-style-type: none"> • With device variables for EtherCAT slave I/O • With Axis Variables for Servo Drive and encoder input slave to which assigned as an axis
SDO Communications (Communications using Service Data Objects)	<p>This method is used to read and write the specified slave unit data from the master unit when required.</p> <p>The NJ-series Machine Automation Controller uses SDO communications for commands to read and write data, such as for parameter transfers, at specified times.</p> <p>The NJ-series Machine Automation Controller can read/write the specified slave data (parameters and error information, etc.) with the EC_CoESDORead (Read CoE SDO) instruction or the EC_CoESDOWrite (Write CoE SDO) instruction.</p>
Slave unit	<p>There are various types of slaves such as Servo Drives that handle position data and I/O terminals that handle the bit signals.</p> <p>The slave unit receives output data sent from the master, and sends input data to the master.</p>
Node address	<p>A node address is an address to identify a unit connected to EtherCAT.</p>
ESI file (EtherCAT Slave Information file)	<p>The ESI files contain information unique to the EtherCAT slaves in XML format.</p> <p>Installing an ESI file enables the Sysmac Studio to allocate slave process data and make other settings.</p>

3. Precautions

- (1) Understand the specifications of devices which are used in the system. Allow some margin for ratings and performance. Provide safety measures, such as installing safety circuit in order to ensure safety and minimize risks of abnormal occurrence.
- (2) To ensure system safety, always read and heed the information provided in all Safety Precautions, Precautions for Safe Use, and Precaution for Correct Use of manuals for each device used in the system.
- (3) The user is encouraged to confirm the standards and regulations that the system must conform to.
- (4) It is prohibited to copy, to reproduce, and to distribute a part or the whole of this document without the permission of OMRON Corporation.
- (5) The information contained in this document is current as of November 2013. It is subject to change without notice for improvement.

The following notation is used in this document.



Indicates a potentially hazardous situation which, if not avoided, will result in minor or moderate injury, or may result in serious injury or death. Additionally there may be significant property damage.



Precautions for Safe Use

Precautions on what to do and what not to do to ensure safe usage of the product.



Precautions for Correct Use

Precautions on what to do and what not to do to ensure proper operation and performance.



Additional Information

Additional information to read as required.

This information is provided to increase understanding or make operation easier.

Symbol



The filled circle symbol indicates operations that you must do.
The specific operation is shown in the circle and explained in text.
This example shows a general precaution for something that must do.

4. Overview

This document describes the procedure for connecting the Vision System (FH series) of OMRON Corporation (hereinafter referred to as OMRON) to NJ-series Machine Automation Controller (hereinafter referred to as the Controller) via EtherCAT and provides the procedure for checking their connection.

Refer to *Section 6 EtherCAT Settings* and *Section 7. EtherCAT Connection Procedure* to understand the setting method and key points to operate PDO communications of EtherCAT.

5. Applicable Devices and Device Configuration

5.1. Applicable Devices

The applicable devices are as follows:

Manufacturer	Name	Model
OMRON	NJ-series CPU Unit	NJ501-□□□□ NJ301-□□□□
OMRON	FH Sensor Controller	FH-1□□□/ FH-1□□□-□□ FH-3□□□/ FH-3□□□-□□
OMRON	0.3 Megapixel Digital Camera 0.3 Megapixel Small Digital Camera 0.3 Megapixel Small Digital Pen-Shaped Camera 0.3 Megapixel High-Speed Camera 0.3 Megapixel High-Speed CMOS Camera 2 Megapixel Digital Camera 2 Megapixel High-Speed CMOS Camera 4 Megapixel High-Speed CMOS Camera 5 Megapixel Digital Camera Intelligent Camera Intelligent Compact Camera Auto-Focus Camera	FZ-SC/S FZ-SFC/SF FZ-SPC/SP FZ-SHC/SH FH-SC/SM FZ-SC2M/S2M FH-SC02/SM02 FH-SC04/SM04 FZ-SC5M2/S5M2 FZ-SLC15/SLC100 FZ-SQ010F/SQ050F/SQ100F/SQ100N FZ-SZC15/SZC100



Precautions for Correct Use

As applicable devices above, the devices with the models and versions listed in *Section 5.2* are actually used in this document to describe the procedure for connecting devices and checking the connection.

You cannot use devices with versions lower than the versions listed in *Section 5.2*.

To use the above devices with versions not listed in *Section 5.2* or versions higher than those listed in *Section 5.2*, check the differences in the specifications by referring to the manuals before operating the devices.



Additional Information

This document describes the procedure to establish the network connection. Except for the connection procedure, it does not provide information on operation, installation or wiring method. It also does not describe the functionality or operation of the devices. Refer to the manuals or contact your OMRON representative.

5.2. Device Configuration

The hardware components to reproduce the connection procedure of this document are as follows:

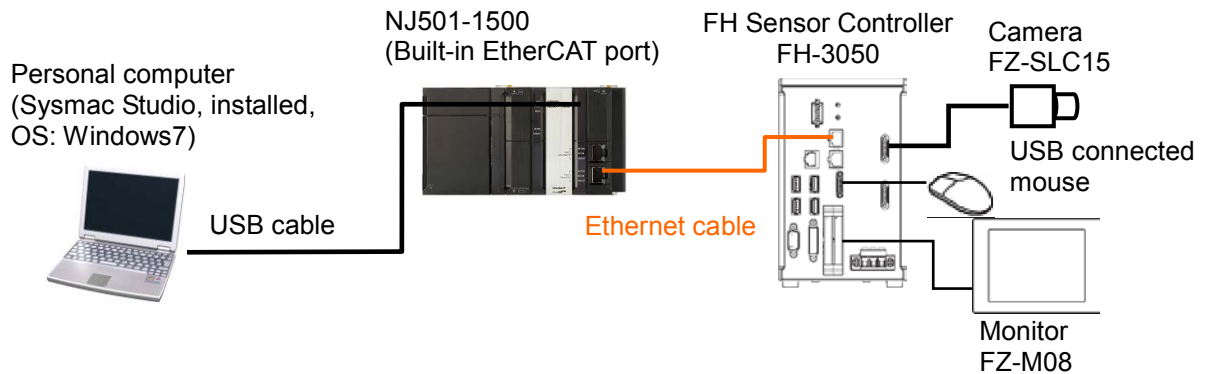

Manufacturer	Name	Model	Version
OMRON	CPU Unit (Built-in EtherCAT port)	NJ501-1500	Ver.1.06
OMRON	Power Supply Unit	NJ-PA3001	
OMRON	Sysmac Studio	SYSMAC-SE2□□□□	Ver.1.07
—	Personal computer (OS: Windows7)	—	
—	USB cable (USB 2.0 type B connector)	—	
OMRON	Ethernet cable (with industrial Ethernet connector)	XS5W-T421-□M□-K	
OMRON	FH Sensor Controller (Camera 2ch type)	FH-3050	Ver.5.00
OMRON	Camera	FZ-SLC15	
OMRON	Camera cable	FZ-VS	
OMRON	Monitor (analog RGB monitor)	FZ-M08	
OMRON	Monitor conversion cable	FH-VMRGB	
—	USB connected mouse	—	



Precautions for Correct Use

The connection line of EtherCAT communication cannot be shared with other Ethernet networks.

Do not use devices for Ethernet such as a switching hub.

Use the cable (double shielding with aluminum tape and braiding) of Category 5 or higher, and use the shielded connector of Category 5 or higher.

Connect the cable shield to the connector hood at both ends of the cable.



Precautions for Correct Use

Update the Sysmac Studio to the version specified in this section or higher version using the auto update function.

If a version not specified in this section is used, the procedures described in *Section 7* and subsequent sections may not be applicable. In that case, use the equivalent procedures described in the *Sysmac Studio Version 1 Operation Manual* (Cat. No. W504).



Additional Information

For specifications of the Ethernet cable and network wiring, refer to *4 EtherCAT Network Wiring* of the *NJ-series CPU Unit Built-in EtherCAT_R Port User's Manual* (Cat. No. W505).



Additional Information

The system configuration in this document uses USB for the connection to the Controller. For how to install a USB driver, refer to *A-1 Driver Installation for Direct USB Cable Connection* of the *Sysmac Studio Version 1 Operation Manual* (Cat.No. W504).

6. EtherCAT Settings

This section describes the specifications such as communication parameters and variables that are set in this document.

Hereinafter, the FH Sensor Controller is referred to as the "Destination Device" or "Slave Unit" in some descriptions.

6.1. EtherCAT Communications Parameter Settings

The communications parameter required connecting the Controller and the Destination Device via EtherCAT is given below.

	FH Sensor Controller
Node address	1

6.2. Allocation for PDO Communications

The EtherCAT PDO communications data of the Destination Device are allocated to the Controller's device variables. The device variables and the data types are shown below.

■ Output area (from Controller to Destination Device)

Device variable name	Data type	Meaning
E001_Line0_Command_Request	BOOL	Request command execution
E001_Line0_Trigger	BOOL	To Start image processing
E001_Line0_Flow_Command_Request	BOOL	Request flow command execution
E001_Line0_Error_Clear	BOOL	Clear Error Status bit
E001_Line0_Result_Set_Request	BOOL	Request to set result data
E001_Line0_Command_Code	DWORD	Command code
E001_Line0_Command_Parameter_0	DINT	Parameter 0 for command
E001_Line0_Command_Parameter_1	DINT	Parameter 1 for command
E001_Line0_Command_Parameter_2	DINT	Parameter 2 for command
E001_Line0_Command_Parameter_3	DINT	Parameter 3 for command

■ Input area (from Destination Device to Controller)

Device variable name	Data type	Meaning
E001_Observation	BOOL	Observation levels of information
E001_Minor_Fault	BOOL	Minor Fault levels of information
E001_Line0_Command_Completion	BOOL	Completed command execution
E001_Line0_Busy	BOOL	In image processing
E001_Line0_Trigger_Ready	BOOL	Possible to trigger ON
E001_Line0_Total_Judgment	BOOL	Total Judgment for inspections
E001_Line0_Run_Mode	BOOL	Mode of Vision Sensor
E001_Line0_Trigger_Ack	BOOL	Trigger ON was Received
E001_Line0_Command_Ready	BOOL	Ready for command execution
E001_Line0_Shutter_Output	BOOL	Completed shutter
E001_Line0_Flow_Command_Completion	BOOL	Flow completed command execution
E001_Line0_Flow_Command_Busy	BOOL	Flow command execution
E001_Line0_Flow_Command_Wait	BOOL	Flow command wait
E001_Line0_Error_Status	BOOL	Error Occurred
E001_Line0_Result_Notification	BOOL	Notification of reporting result data
E001_Line0_Command_Code_Echo_Back	DWORD	Command Code Echo Back
E001_Line0_Response_Code	DWORD	Response Code
E001_Line0_Response_Data_0	DINT	Return value of command
E001_Line0_Error_Code	DWORD	Error Code
E001_Line0_DINT_Result_Data_0	DINT	DINT Result Data 0 of image processing
E001_Line0_DINT_Result_Data_1	DINT	DINT Result Data 1 of image processing
E001_Line0_DINT_Result_Data_2	DINT	DINT Result Data 2 of image processing
E001_Line0_DINT_Result_Data_3	DINT	DINT Result Data 3 of image processing
E001_Line0_DINT_Result_Data_4	DINT	DINT Result Data 4 of image processing
E001_Line0_DINT_Result_Data_5	DINT	DINT Result Data 5 of image processing
E001_Line0_DINT_Result_Data_6	DINT	DINT Result Data 6 of image processing
E001_Line0_DINT_Result_Data_7	DINT	DINT Result Data 7 of image processing

7. EtherCAT Connection Procedure

This section describes the procedure for connecting the Controller to the FH Sensor Controller via EtherCAT.

This document explains the procedures for setting up the Controller and the FH Sensor Controller from the factory default setting. For the initialization, refer to *Section 8 Initialization Method*.

7.1. Work Flow

Take the following steps to perform PDO communications of EtherCAT.

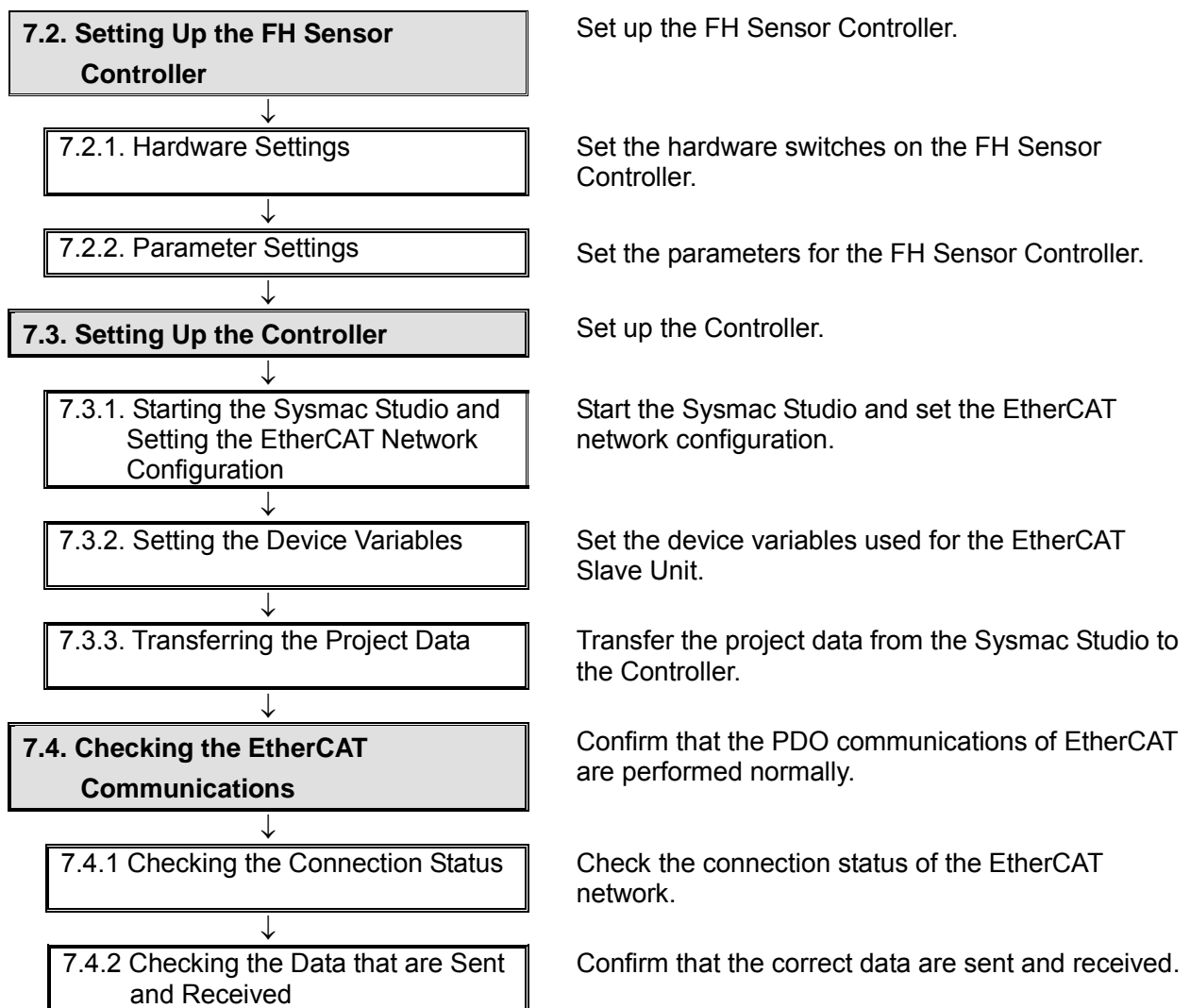

7.2. Setting Up the FH Sensor Controller

Set up the FH Sensor Controller.

7.2.1. Hardware Settings

Set the hardware switches on the FH Sensor Controller.



Precautions for Correct Use

Make sure that the power supply is OFF when you perform the setting up.

- 1 Make sure that the power supply to the FH Sensor Controller is OFF.

* If the power supply is turned ON, settings may not be applicable as described in the following procedure.

- 2 Check the position of the switches on the FH Sensor Controller by referring to the right figure.

G: EtherCAT address setup volume [ADR]

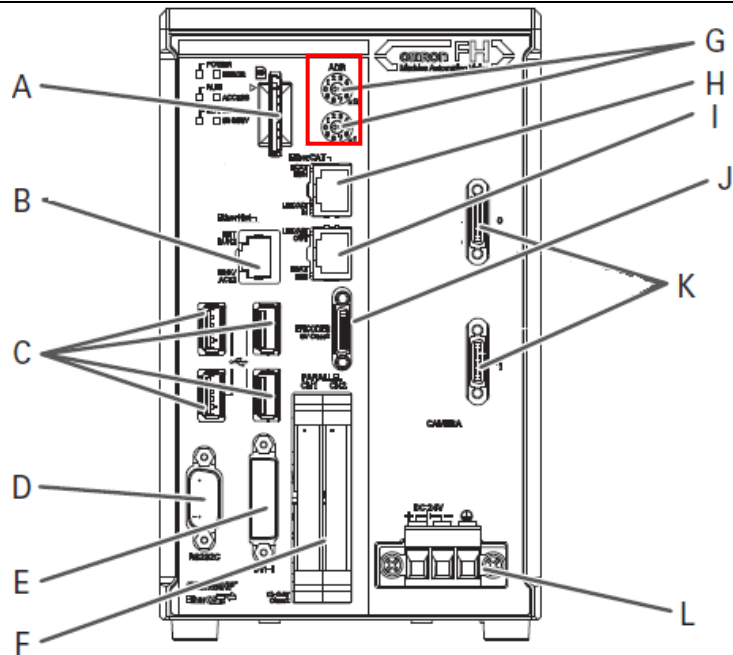

Connector name	Description
A	SD memory card installation connector Install the SD memory card. Do not plug or unplug the SD card during measurement operation. Otherwise measurement time may be affected or data may be destroyed.
B	Ethernet connector Connect an Ethernet device.
C	USB connector Connect a USB device. Do not plug or unplug it during measurement. Measurement time might be affected otherwise.
D	RS-232C connector Connect an external device such as a programmable controller.
E	DVI-I connector Connect a monitor.
F	I/O connector(control lines, data lines) Connect the controller to external devices such as a sync sensor and PLC.
G	EtherCAT address setup volume Used to set a station address as an EtherCAT communication device.
H	EtherCAT communication connector (IN) Connect the opposed EtherCAT device.
I	EtherCAT communication connector (OUT) Connect the opposed EtherCAT device.
J	Encoder connector Connect an encoder.
K	Camera connector Connect cameras.
L	Power supply terminal connector Connect a DC power supply. Wire the controller independently on other devices. Wire the ground line. Be sure to ground the controller alone. Perform wiring using the attached power supply connector as referring to the description of wiring that connector.

3 Set the EtherCAT address setup volume [ADR] as follows:

X10: 0

X1: 1

* Set the address to 01.

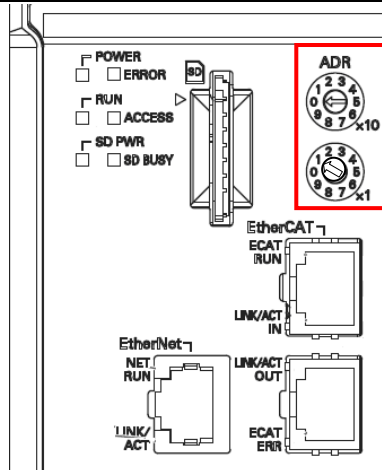

7.2.2. Parameter Settings

Set the parameters for the FH Sensor Controller.

1 Check the position of the connectors on the FH Sensor Controller by referring to the right figure.

H: Connect the Ethernet cable to the EtherCAT communication connector.

K: Connect the camera cable to the camera connector.

E: Connect the DVI-I connector to the monitor connected with the monitor conversion cable.

C: Connect the mouse to the USB connector.

L: Connect the power supply cable to the power supply terminal connector.

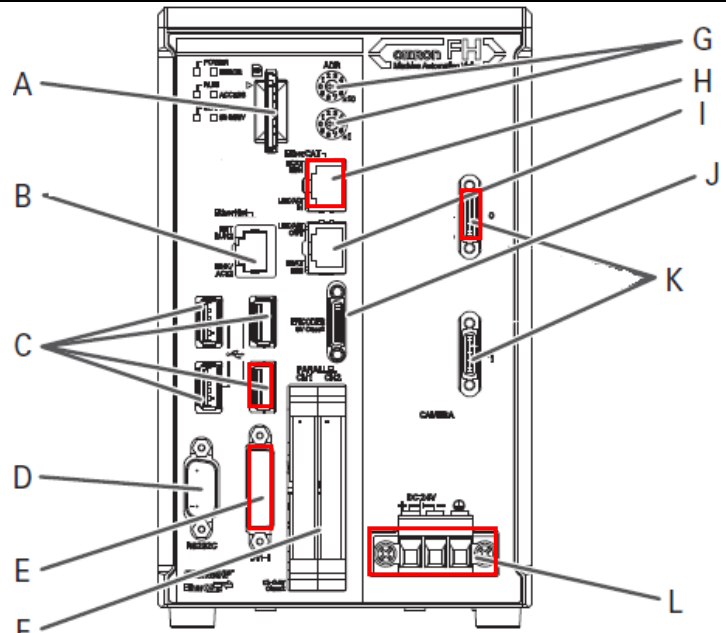

Connector name	Description
A	SD memory card installation connector Install the SD memory card. Do not plug or unplug the SD card during measurement operation. Otherwise measurement time may be affected or data may be destroyed.
B	Ethernet connector Connect an Ethernet device.
C	USB connector Connect a USB device. Do not plug or unplug it during measurement. Measurement time might be affected otherwise.
D	RS-232C connector Connect an external device such as a programmable controller.
E	DVI-I connector Connect a monitor.
F	I/O connector(control lines, data lines) Connect the controller to external devices such as a sync sensor and PLC.
G	EtherCAT address setup volume Used to set a station address as an EtherCAT communication device.
H	EtherCAT communication connector (IN) Connect the opposed EtherCAT device.
I	EtherCAT communication connector (OUT) Connect the opposed EtherCAT device.
J	Encoder connector Connect an encoder.
K	Camera connector Connect cameras.
L	Power supply terminal connector Connect a DC power supply. Wire the controller independently on other devices. Wire the ground line. Be sure to ground the controller alone. Perform wiring using the attached power supply connector as referring to the description of wiring that connector.

2 Turn ON the power supply to the FH Sensor Controller.

3 The Language setting Dialog Box is displayed on the monitor connected to the FH Sensor Controller only at the initial start. Select **English** and click the **OK** Button.

The dialog box on the right is displayed. Click the **Yes** Button.

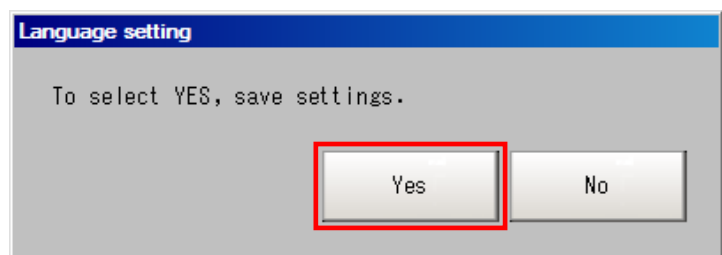
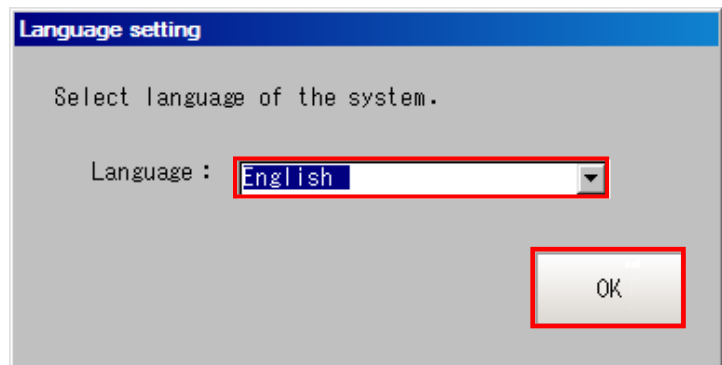

- 4 Select **System Settings** from the Tool Menu.

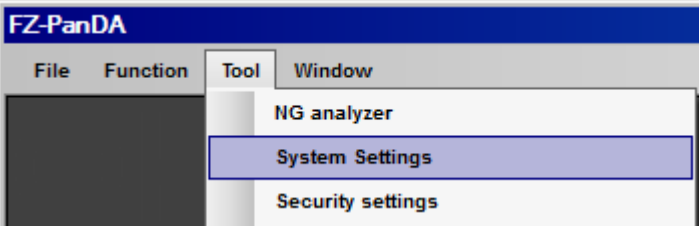

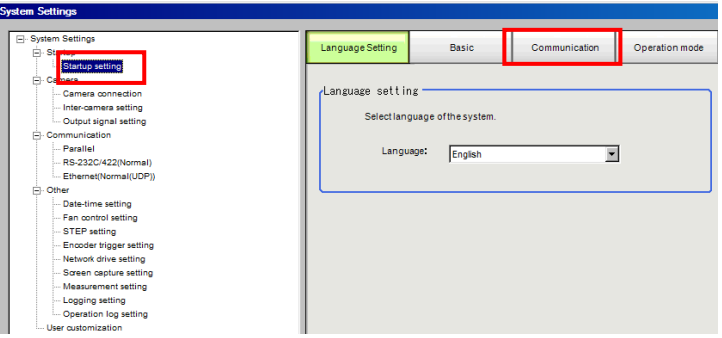
- 5 Select **System Settings-Startup-Startup setting**. The Language setting Dialog Box is displayed. Select the **Communication** Tab.

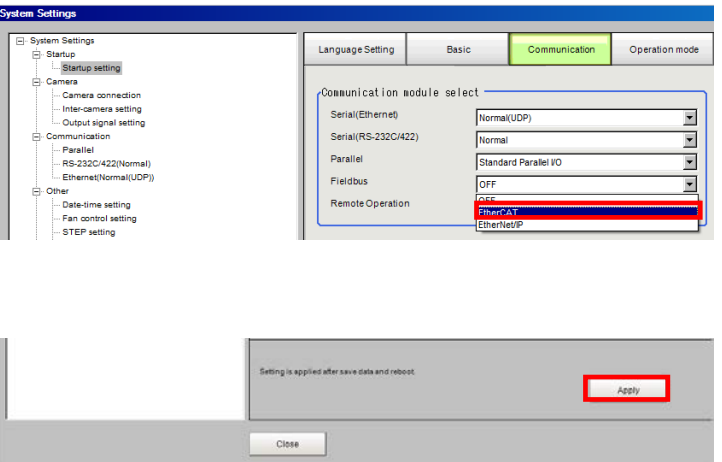

- 6 The Communication module select Dialog Box is displayed. Select **EtherCAT** from the Fieldbus pull-down list. Then, click the **Apply** Button.

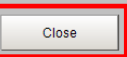
* The data set in the System Settings Dialog Box as shown on the right becomes enabled after the settings are saved, and then the FH Sensor Controller is restarted.

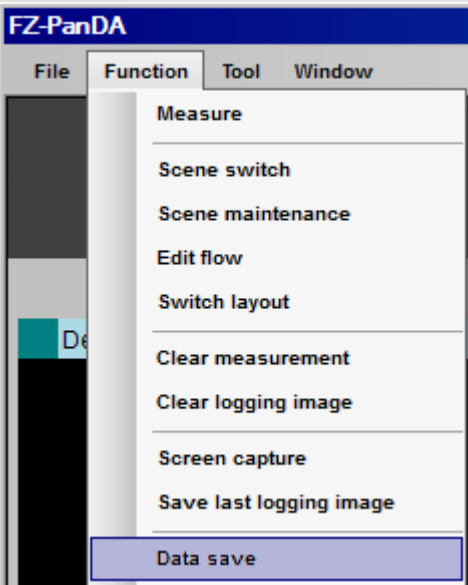
- 7 Click the **Close** Button to close the System Settings Dialog Box.

- 8 Select **Data save** from the Function Menu.

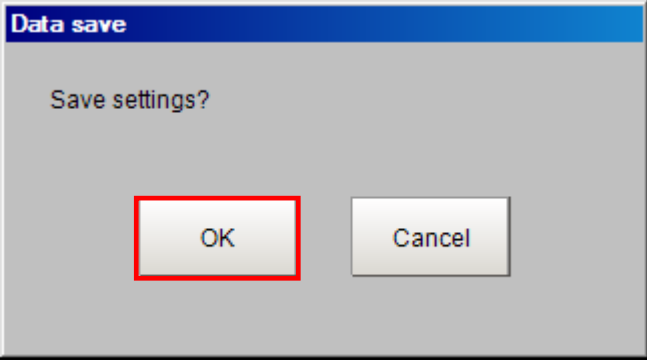
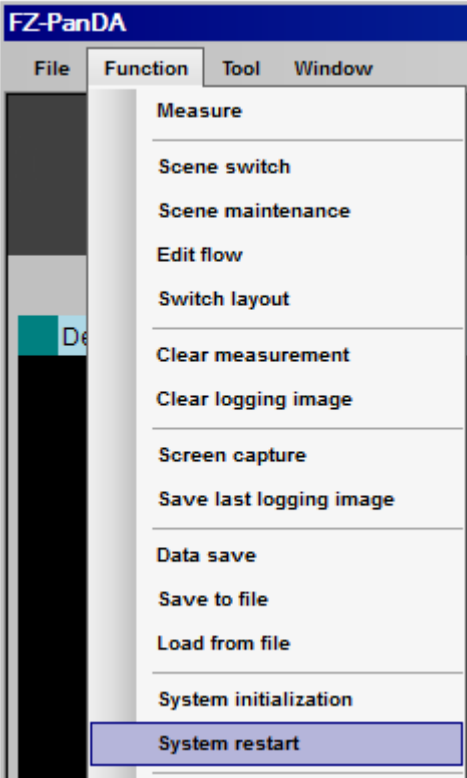
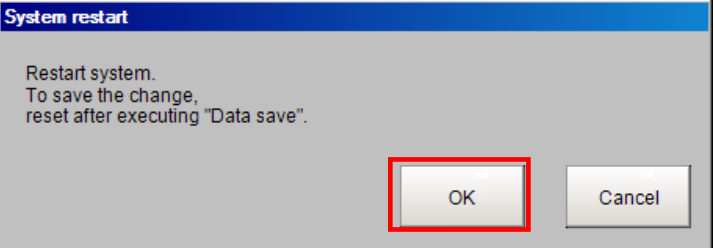

- | | | |
|----|---|--|
| 9 | The Data save Dialog Box is displayed. Click the OK Button. |  |
| 10 | Select System restart from the Function Menu. |  |
| 11 | The System restart Dialog Box is displayed. Click the OK Button. |  |

7.3. Setting Up the Controller

Set up the Controller.

7.3.1. Starting the Sysmac Studio and Setting the EtherCAT Network Configuration

Start the Sysmac Studio and set the EtherCAT network configuration.

Install the Sysmac Studio and USB driver in the personal computer beforehand.

- 1 Connect the Ethernet cable to the built-in EtherCAT port (PORT2) of the Controller and the USB cable to the peripheral (USB) port. As shown in 5.2. *Device Configuration*, connect the personal computer, FH Sensor Controller, and the Controller.

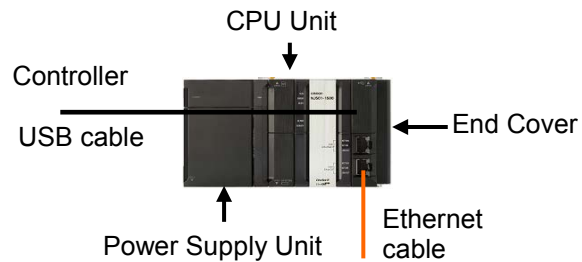

- 2 Turn ON the power supply to the Controller.

- 3 Start the Sysmac Studio. Click the **New Project** Button.

* If a confirmation dialog for an access right is displayed at start, select to start.

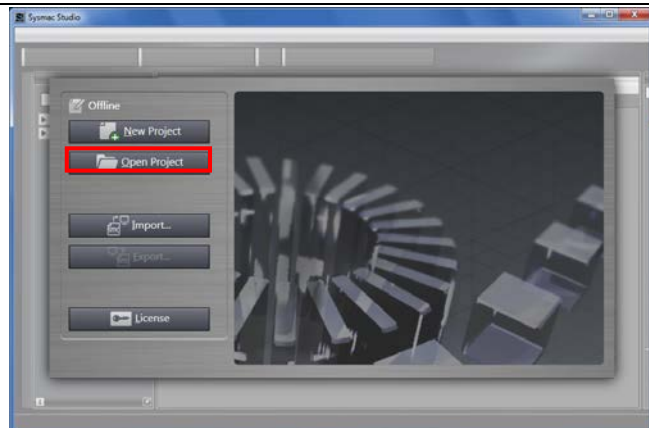

4 The Project Properties Dialog Box is displayed.

* In this document, New Project is used as the Project name.

Confirm that the device you use is shown in the *Category* and *Device* Fields of Select Device.

Select version **1.06** from the pull-down list of Version.

* Although 1.06 is selected in this document for example, select the version you actually use.

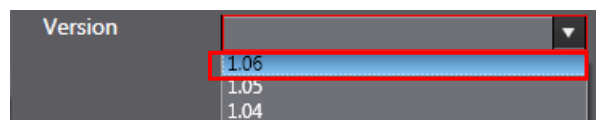
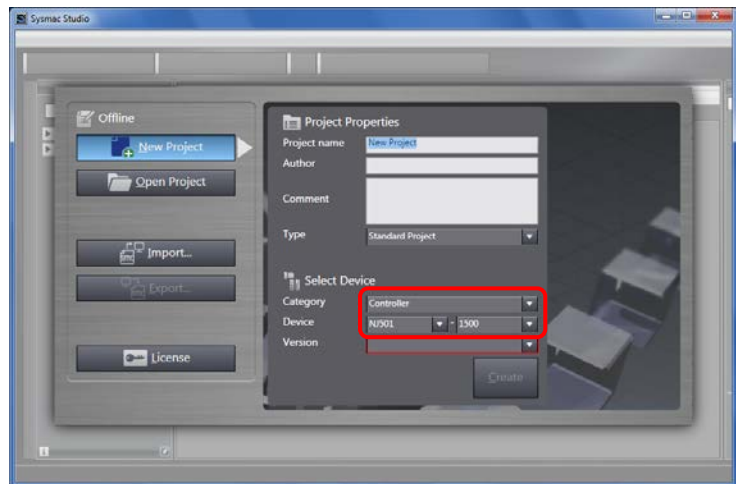

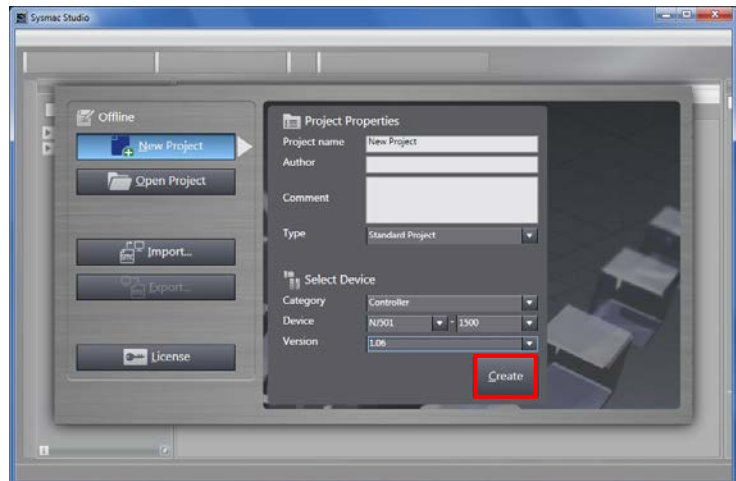

5 Click the **Create** Button.

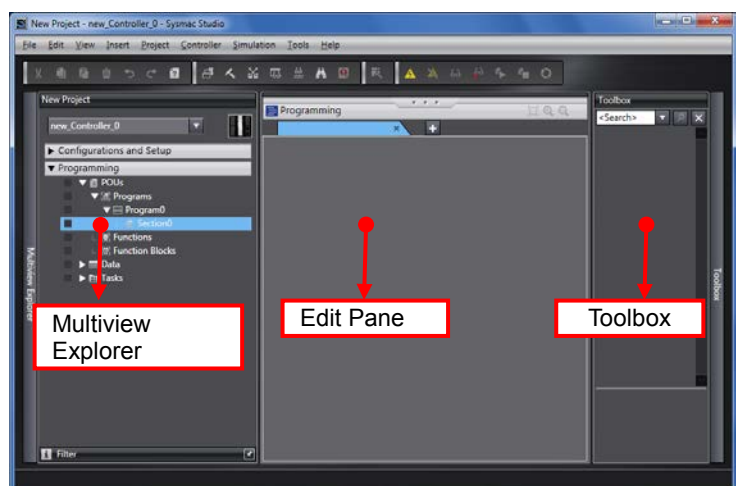

6 The New Project is displayed. The left pane is called Multiview Explorer, the right pane is called Toolbox and the middle pane is called Edit Pane.

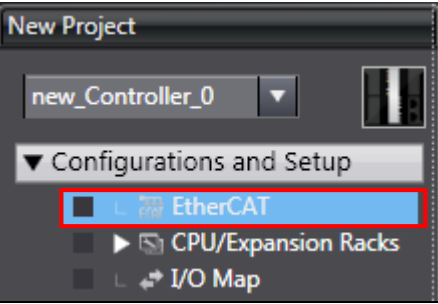
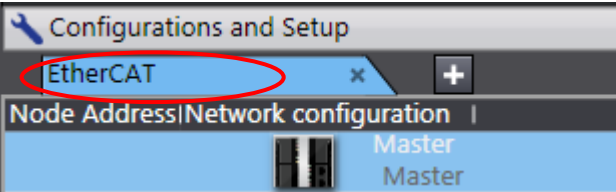
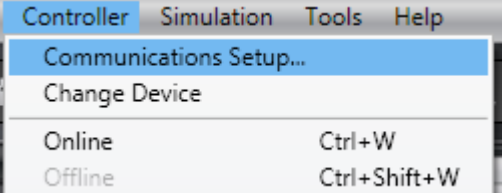
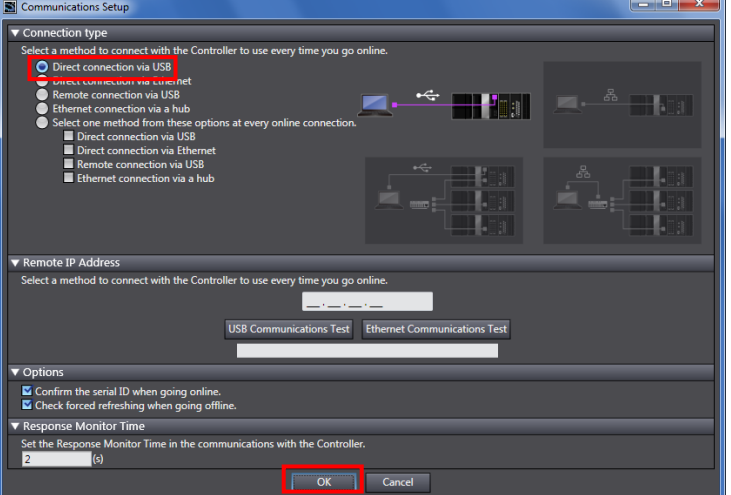
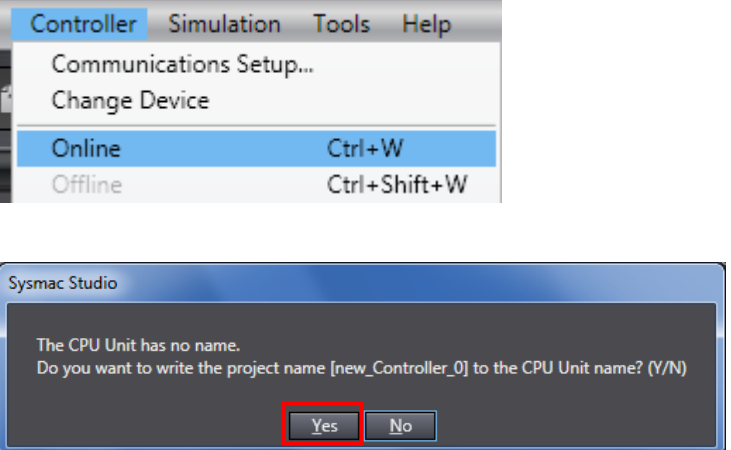

<p>7 Double-click EtherCAT under Configurations and Setup in the Multiview Explorer.</p>	
<p>8 The EtherCAT Tab is displayed on the Edit Pane.</p>	
<p>9 Select Communications Setup from the Controller Menu.</p>	
<p>10 The Communications Setup Dialog Box is displayed. Select the <i>Direct connection via USB</i> Option for Connection Type.</p> <p>Click the OK Button.</p>	
<p>11 Select Online from the Controller Menu. A confirmation dialog box is displayed. Click the Yes Button.</p> <p>* The displayed dialog depends on the status of the Controller used. Check the contents and click the Yes Button to proceed with the processing.</p>	
<p>12 When an online connection is established, a yellow bar is displayed on the top of the Edit Pane.</p>	



Additional Information

For details on online connections to a Controller, refer to *Section 5 Online Connections to a Controller* of the *Sysmac Studio Version 1 Operation Manual* (Cat. No. W504).

- 13 Right-click **Master** on the EtherCAT Tab Page, and select **Compare and Merge with Actual Network Configuration**.

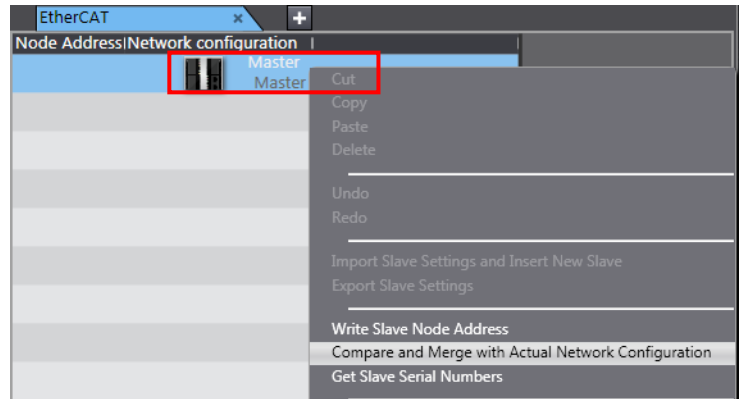

A screen is displayed stating "Get information is being executed".

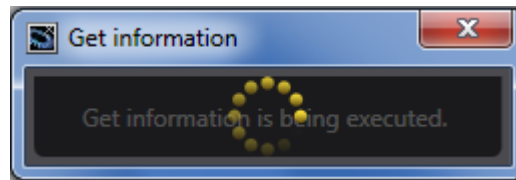

- 14 The Compare and Merge with Actual Network Configuration Pane is displayed. Node address 1 and FH-3050 Rev.1.0 are added to the Actual network configuration after the comparison. Click the **Apply actual network configuration** Button.

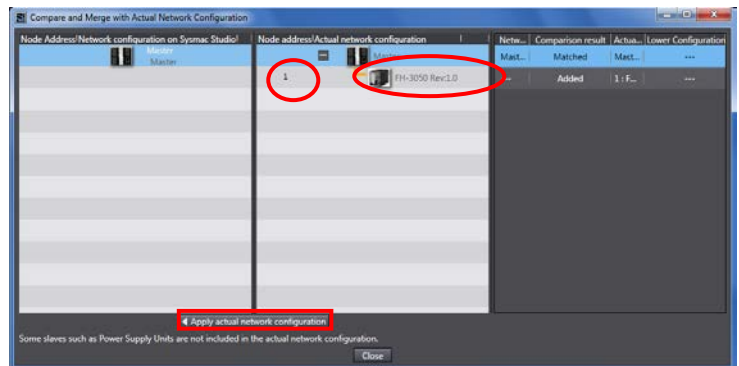

- 15 A confirmation dialog box is displayed. Check the contents and click the **Apply** Button.

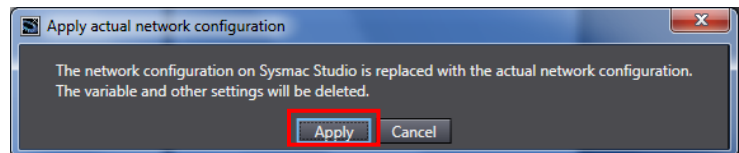

Node address 1, E001, and FH-3050 Rev.1.0 are added to the Network configuration on Sysmac Studio.

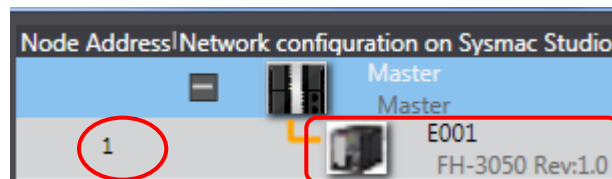

Confirm that they were added and click the **Close** Button.

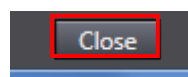

16 Node address 1, E001, and FH-3050 Rev:1.0 are added to the EtherCAT Tab Page in the Edit Pane.

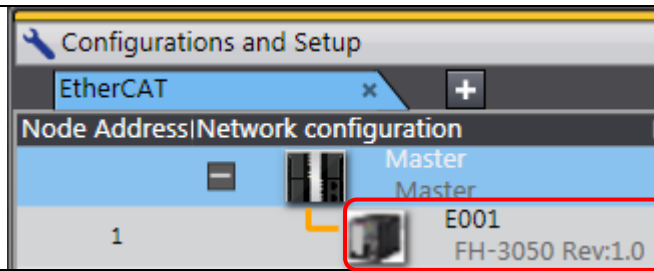

7.3.2. Setting the Device Variables

Set the device variables used for the EtherCAT Slave Unit.

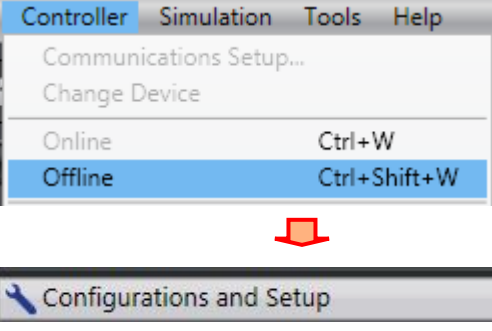
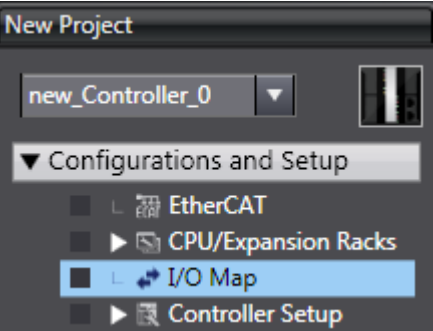
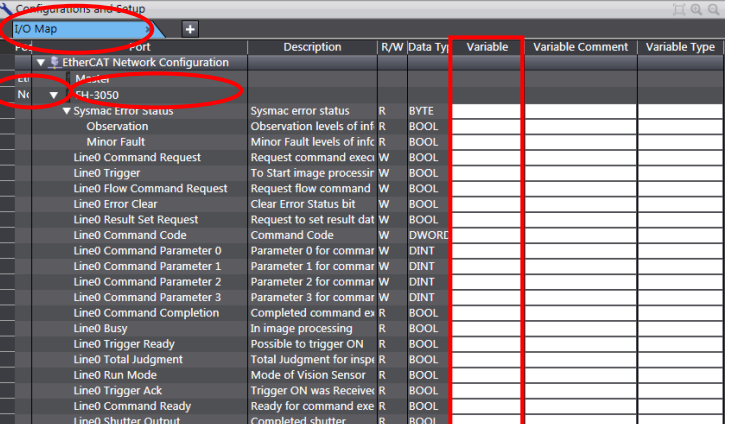
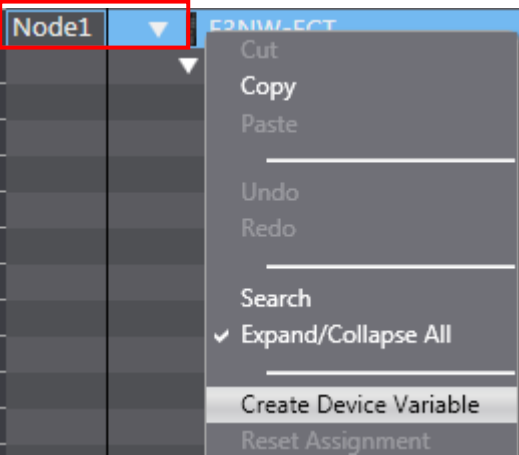
<p>1</p>	<p>Select Offline from the Controller Menu.</p> <p>The yellow bar on the top of the Edit Pane disappears.</p>																																																																																																																																																											
<p>2</p>	<p>Double-click I/O Map under Configurations and Setup in the Multiview Explorer.</p>																																																																																																																																																											
<p>3</p>	<p>The I/O Map Tab is displayed on the Edit Pane.</p> <p>Confirm that Node1 is displayed in the <i>Position</i> Column and the Slave Unit is displayed.</p> <p>* To manually set a variable name for the Slave Unit, click a column under the <i>Variable</i> Column and enter a name.</p>	 <table border="1" data-bbox="715 1016 1447 1438"> <thead> <tr> <th>Port</th> <th>Description</th> <th>R/W</th> <th>Data Type</th> <th>Variable</th> <th>Variable Comment</th> <th>Variable Type</th> </tr> </thead> <tbody> <tr> <td>Node1</td> <td>Systemac error status</td> <td>R</td> <td>BYTE</td> <td></td> <td></td> <td></td> </tr> <tr> <td></td> <td>Observation levels of inf</td> <td>R</td> <td>BOOL</td> <td></td> <td></td> <td></td> </tr> <tr> <td></td> <td>Minor Fault levels of inf</td> <td>R</td> <td>BOOL</td> <td></td> <td></td> <td></td> </tr> <tr> <td></td> <td>Request command execu</td> <td>W</td> <td>BOOL</td> <td></td> <td></td> <td></td> </tr> <tr> <td></td> <td>To Start image processir</td> <td>W</td> <td>BOOL</td> <td></td> <td></td> <td></td> </tr> <tr> <td></td> <td>Request flow command</td> <td>W</td> <td>BOOL</td> <td></td> <td></td> <td></td> </tr> <tr> <td></td> <td>Clear Error Status bit</td> <td>W</td> <td>BOOL</td> <td></td> <td></td> <td></td> </tr> <tr> <td></td> <td>Request to set result dat</td> <td>W</td> <td>BOOL</td> <td></td> <td></td> <td></td> </tr> <tr> <td></td> <td>Command Code</td> <td>W</td> <td>DWORD</td> <td></td> <td></td> <td></td> </tr> <tr> <td></td> <td>Parameter 0 for commar</td> <td>W</td> <td>DINT</td> <td></td> <td></td> <td></td> </tr> <tr> <td></td> <td>Parameter 1 for commar</td> <td>W</td> <td>DINT</td> <td></td> <td></td> <td></td> </tr> <tr> <td></td> <td>Parameter 2 for commar</td> <td>W</td> <td>DINT</td> <td></td> <td></td> <td></td> </tr> <tr> <td></td> <td>Parameter 3 for commar</td> <td>W</td> <td>DINT</td> <td></td> <td></td> <td></td> </tr> <tr> <td></td> <td>Completed command e</td> <td>R</td> <td>BOOL</td> <td></td> <td></td> <td></td> </tr> <tr> <td></td> <td>In image processing</td> <td>R</td> <td>BOOL</td> <td></td> <td></td> <td></td> </tr> <tr> <td></td> <td>Possible to trigger ON</td> <td>R</td> <td>BOOL</td> <td></td> <td></td> <td></td> </tr> <tr> <td></td> <td>Total Judgment for insp</td> <td>R</td> <td>BOOL</td> <td></td> <td></td> <td></td> </tr> <tr> <td></td> <td>Mode of Vision Sensor</td> <td>R</td> <td>BOOL</td> <td></td> <td></td> <td></td> </tr> <tr> <td></td> <td>Trigger ON was Receiver</td> <td>R</td> <td>BOOL</td> <td></td> <td></td> <td></td> </tr> <tr> <td></td> <td>Ready for command exe</td> <td>R</td> <td>BOOL</td> <td></td> <td></td> <td></td> </tr> <tr> <td></td> <td>Completed shutter</td> <td>R</td> <td>BOOL</td> <td></td> <td></td> <td></td> </tr> </tbody> </table>	Port	Description	R/W	Data Type	Variable	Variable Comment	Variable Type	Node1	Systemac error status	R	BYTE					Observation levels of inf	R	BOOL					Minor Fault levels of inf	R	BOOL					Request command execu	W	BOOL					To Start image processir	W	BOOL					Request flow command	W	BOOL					Clear Error Status bit	W	BOOL					Request to set result dat	W	BOOL					Command Code	W	DWORD					Parameter 0 for commar	W	DINT					Parameter 1 for commar	W	DINT					Parameter 2 for commar	W	DINT					Parameter 3 for commar	W	DINT					Completed command e	R	BOOL					In image processing	R	BOOL					Possible to trigger ON	R	BOOL					Total Judgment for insp	R	BOOL					Mode of Vision Sensor	R	BOOL					Trigger ON was Receiver	R	BOOL					Ready for command exe	R	BOOL					Completed shutter	R	BOOL			
Port	Description	R/W	Data Type	Variable	Variable Comment	Variable Type																																																																																																																																																						
Node1	Systemac error status	R	BYTE																																																																																																																																																									
	Observation levels of inf	R	BOOL																																																																																																																																																									
	Minor Fault levels of inf	R	BOOL																																																																																																																																																									
	Request command execu	W	BOOL																																																																																																																																																									
	To Start image processir	W	BOOL																																																																																																																																																									
	Request flow command	W	BOOL																																																																																																																																																									
	Clear Error Status bit	W	BOOL																																																																																																																																																									
	Request to set result dat	W	BOOL																																																																																																																																																									
	Command Code	W	DWORD																																																																																																																																																									
	Parameter 0 for commar	W	DINT																																																																																																																																																									
	Parameter 1 for commar	W	DINT																																																																																																																																																									
	Parameter 2 for commar	W	DINT																																																																																																																																																									
	Parameter 3 for commar	W	DINT																																																																																																																																																									
	Completed command e	R	BOOL																																																																																																																																																									
	In image processing	R	BOOL																																																																																																																																																									
	Possible to trigger ON	R	BOOL																																																																																																																																																									
	Total Judgment for insp	R	BOOL																																																																																																																																																									
	Mode of Vision Sensor	R	BOOL																																																																																																																																																									
	Trigger ON was Receiver	R	BOOL																																																																																																																																																									
	Ready for command exe	R	BOOL																																																																																																																																																									
	Completed shutter	R	BOOL																																																																																																																																																									
<p>4</p>	<p>Right-click Node1 and select Create Device Variable.</p>																																																																																																																																																											

5 The variable names and variable types are automatically set.

Position	Port	Description	R/W	Data Type	Variable	Variable Comment	Variable Type
EtherC	Master						
Node1	E11-3090	▼ Sysmac Error Status					
		Sysmac error status	R	BYTE	E001_SysmacE		Global Variables
		Observation	R	BOOL	E001_Observa		Global Variables
		Minor Fault	R	BOOL	E001_Minor_F		Global Variables
		Line0 Command Request	W	BOOL	E001_Line0_C		Global Variables
		Line0 Trigger	W	BOOL	E001_Line0_Tr		Global Variables
		Line0 Flow Command Request	W	BOOL	E001_Line0_Fl		Global Variables
		Line0 Error Clear	W	BOOL	E001_Line0_Er		Global Variables
		Line0 Result Set Request	W	BOOL	E001_Line0_Rs		Global Variables
		Line0 Command Code	W	DWORD	E001_Line0_C		Global Variables
		Line0 Command Parameter 0	W	DINT	E001_Line0_C		Global Variables
		Line0 Command Parameter 1	W	DINT	E001_Line0_C		Global Variables
		Line0 Command Parameter 2	W	DINT	E001_Line0_C		Global Variables
		Line0 Command Parameter 3	W	DINT	E001_Line0_C		Global Variables
		Line0 Command Completion	R	BOOL	E001_Line0_C		Global Variables
		Line0 Busy	R	BOOL	E001_Line0_Bu		Global Variables
		Line0 Trigger Ready	R	BOOL	E001_Line0_Tr		Global Variables
		Line0 Total Judgment	R	BOOL	E001_Line0_Tc		Global Variables
		Line0 Run Mode	R	BOOL	E001_Line0_R		Global Variables
		Line0 Trigger Ack	R	BOOL	E001_Line0_Tr		Global Variables
		Line0 Command Ready	R	BOOL	E001_Line0_C		Global Variable



Additional Information

The device variables are named automatically from a combination of the device names and the port names.

For slave units, the default device names start with an "E" followed by a sequential number starting from "001".



Additional Information

In this document, device variables are automatically named for a unit (a slave). Device variables can also be manually named for I/O ports.

7.3.3. Transferring the Project Data

Transfer the project data from the Sysmac Studio to the Controller.

WARNING

Always confirm safety at the Destination Device before you transfer a user program, configuration data, setup data, device variables, or values in memory used for CJ-series Units from the Sysmac Studio.

The devices or machines may perform unexpected operation regardless of the operating mode of the CPU Unit.

Precautions for Safe Use

After you transfer the user program, the CPU Unit restarts and communications with the EtherCAT slaves are cut off. During that period, the slave outputs behave according to the slave settings. The time that communications are cut off depends on the EtherCAT network configuration.

Before you transfer the user program, confirm that it will not adversely affect the device.

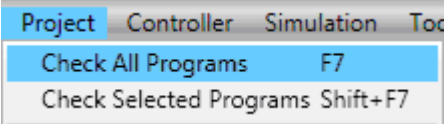
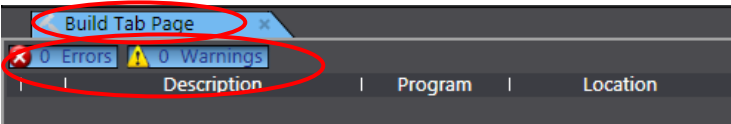
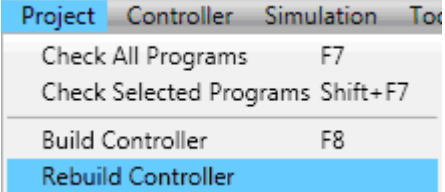
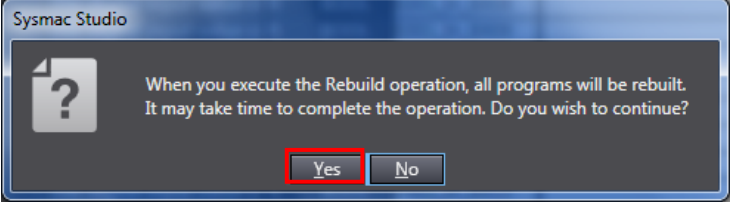
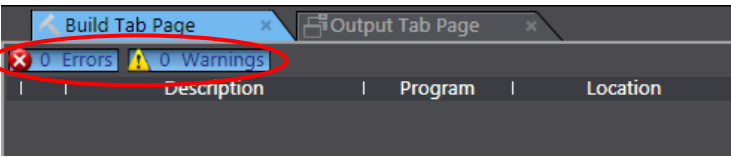
1	Select Check All Programs from the Project Menu.	
2	The Build Tab Page is displayed on the Edit Pane. Confirm that "0 Errors" and "0 Warnings" are displayed.	
3	Select Rebuild Controller from the Project Menu.	
4	A confirmation dialog box is displayed. Confirm that there is no problem and click the Yes Button.	
5	Confirm that "0 Errors" and "0 Warnings" are displayed in the Build Tab Page.	

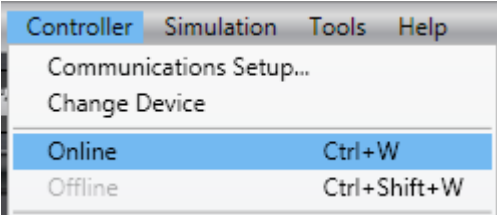
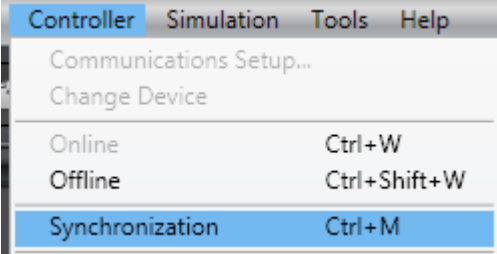
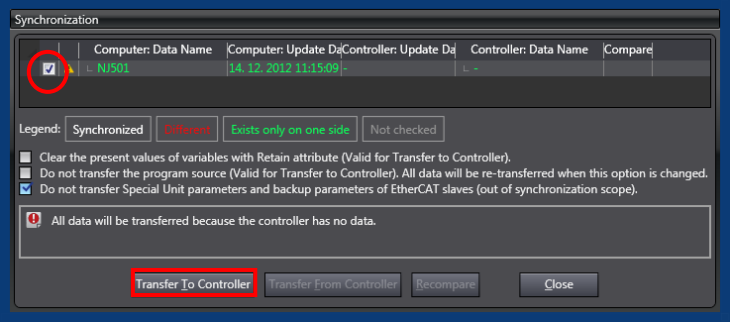
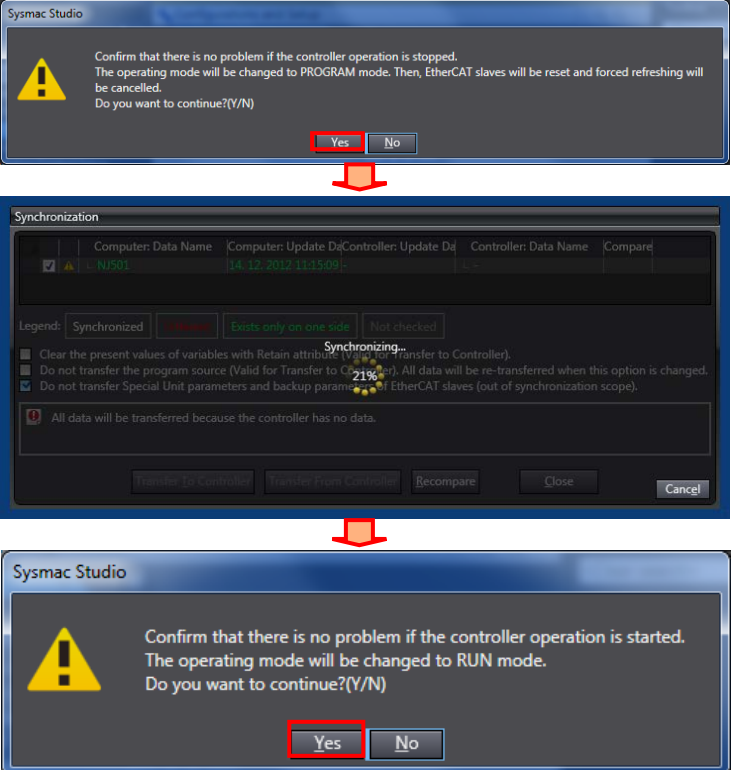
<p>6 Select Online from the Controller Menu.</p>	
<p>7 Select Synchronization from the Controller Menu.</p>	
<p>8 The Synchronization Dialog Box is displayed. Confirm that the data to transfer (NJ501 in the right dialog) is selected. Then, click the Transfer To Controller Button.</p> <p>* After executing the Transfer To Controller, the Sysmac Studio data is transferred to the Controller and the data are compared.</p>	
<p>9 A confirmation dialog box is displayed. Confirm that there is no problem and click the Yes Button.</p> <p>A screen stating "Synchronizing" is displayed.</p> <p>A confirmation dialog box is displayed. Confirm that there is no problem and click the No Button.</p>	

10 Confirm that the synchronized data is displayed with the color specified by "Synchronized" and that a message is displayed stating "The synchronization process successfully finished". If there is no problem, click the **Close** Button.

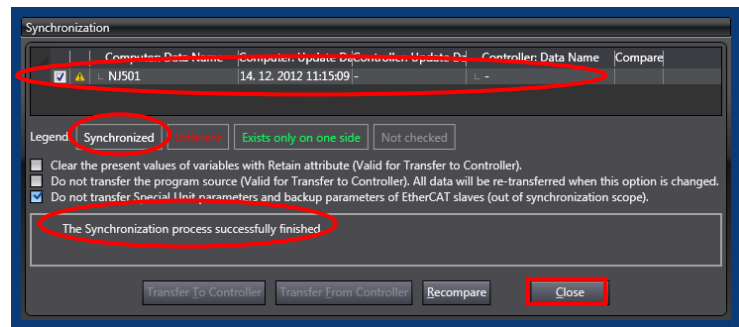

* A message stating "The synchronization process successfully finished" is displayed if the Sysmac Studio project data and the data in the Controller match.

* If the synchronization fails, check the wiring and repeat from step 1.

7.4. Checking the EtherCAT Communications

Confirm that the PDO communications of EtherCAT are performed normally.

7.4.1. Checking the Connection Status

Check the connection status of the EtherCAT network.

1 Confirm that the EtherCAT communications are performed normally by checking the LED indicators on the Controller.

The LED indicators in normal status are as follows:

- [NET RUN]: Lit green
- [NET ERR]: Not lit
- [LINK/ACT]: Flashing yellow

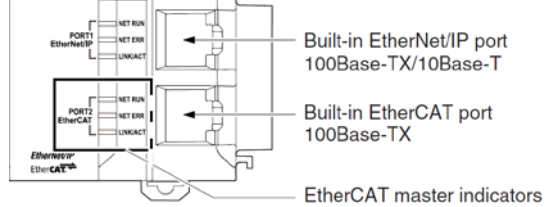

Label	Name	Color	Status	Meaning
EtherCAT NET RUN	RUN	Green	Lit	EtherCAT communications are in progress. • I/O data is being input and output.
			Flashing	EtherCAT communications are established. Communications is in one of the following states. • Only message communications is functioning. • Only message communications and I/O data input operations are functioning.
			Not lit	EtherCAT communications are stopped. • Power is OFF or the Unit is being reset. • There is a MAC address error, communications controller error, or other error.
EtherCAT NET ERR	ERROR	Red	Lit	There is an unrecoverable error, such as a hardware error or an exception.
			Flashing	There is a recoverable error.
			Not lit	There is no error.
EtherCAT LINK/ACT	Link/Activity	Yellow	Lit	The link is established.
			Flashing	A link is established and data is being sent and received. The indicator flashes whenever data is sent or received.
			Not lit	The link is not established.

2 Check the LED indicators on the FH Sensor Controller.

The LED indicators in normal status are as follows:

[POWER]: Lit green

[ERROR]: Not lit

[ECAT RUN]: Lit green

[LINK/ACT IN]: Flashing green

[ECAT ERR]: Not lit

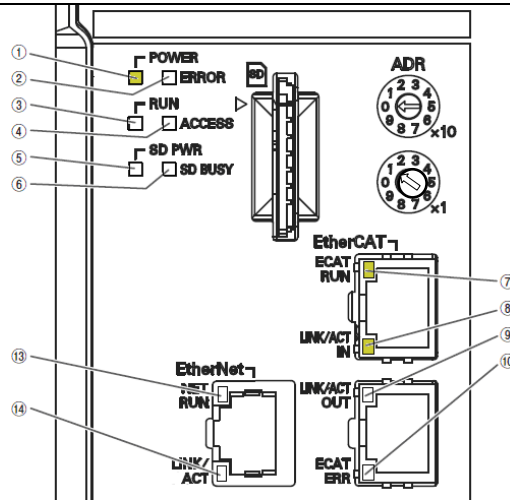

(FH Sensor Controller)

LED name	Description	Description
①	POWER LED	Lit while power is ON.
②	ERROR LED	Lit when an error has occurred.
③	RUN LED	Lit while the controller is in Measurement Mode.
④	ACCESS LED	Lit while the memory is accessed.
⑤	SD POWER LED	Lit while power is supplied to the SD card and the card is usable.
⑥	SD BUSY LED	Blinks while the SD memory card is accessed.
⑦	EtherCAT RUN LED	Lit while EtherCAT communications are usable.
⑧	EtherCAT LINK/ACT IN LED	Lit when connected with an EtherCAT device, and blinks while performing communications.
⑨	EtherCAT LINK/ACT OUT LED	Lit when connected with an EtherCAT device, and blinks while performing communications.
⑩	EtherCAT ERR LED	Lit when EtherCAT communications have become abnormal.
⑪	EtherNet NET RUN1 LED	Lit while EtherCAT communications are usable.
⑫	EtherNet NET LINK/ACK1 LED	Lit when connected with an Ethernet device, and blinks while performing communications.
⑬	EtherNet NET RUN2 LED	Lit when Ethernet communications are usable.
⑭	EtherNet NET LINK/ACK2 LED	Lit when connected with an Ethernet device, and blinks while performing communications.

7.4.2. Checking the Data that are Sent and Received

Confirm that the correct data are sent and received.



WARNING

Always confirm safety at the Destination Device before you transfer a user program, configuration data, setup data, device variables, or values in memory used for CJ-series Units from the Sysmac Studio.

The devices or machines may perform unexpected operation regardless of the operating mode of the CPU Unit.

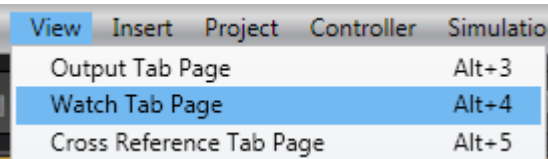

- 1 Select **Watch Tab Page** from the View Menu.

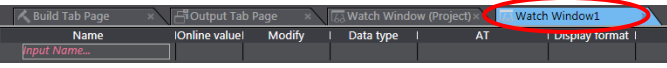

- 2 The Watch Window1 Tab Page is displayed in the lower section of the Edit Pane.

- 3 Enter the following names in the Watch Window1 Tab Page for monitoring.
Click a *Name* Column to enter a new name.

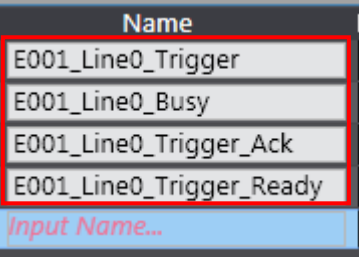
E001_Line0_Trigger
E001_Line0_Busy
E001_Line0_Trigger_Ack
E001_Line0_Trigger_Ready

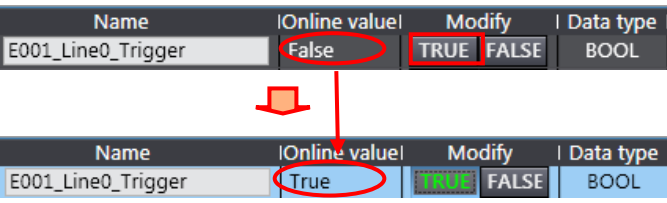
- 4 Confirm that the Online value of *E001_Line0_Trigger* is False and click **TRUE** in the *Modify* Column. Confirm that the Online value changes to True.

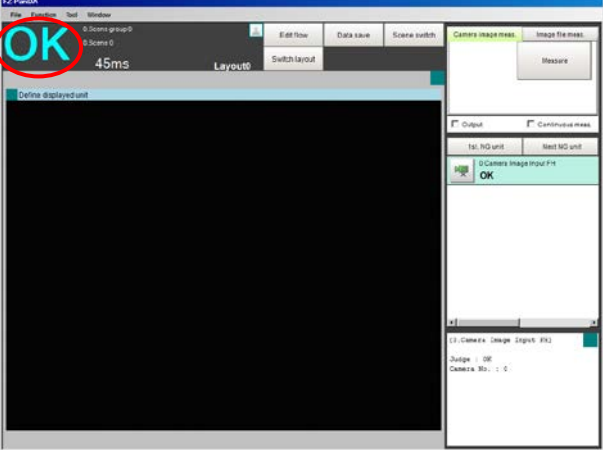
- 5 After the measurement is completed, OK is displayed on the dialog box.



6 Confirm that the Online value of *E001_Line0_Trigger_Ack* is True.

Name	Online value	Modify		Data type
E001_Line0_Trigger	True	<input checked="" type="checkbox"/>	FALSE	BOOL
E001_Line0_Busy	False	TRUE	FALSE	BOOL
E001_Line0_Trigger_Ack	True	TRUE	FALSE	BOOL
E001_Line0_Trigger_Ready	True	TRUE	FALSE	BOOL

8. Initialization Method

This document explains the setting procedure from the factory default setting. Some settings may not be applicable as described in this document unless you use the devices with the factory default setting.

8.1. Initializing the Controller

To initialize the settings of the Controller, select **Clear All Memory** from the Controller Menu of the Sysmac Studio. The Clear All Memory Dialog Box is displayed. Check the contents and click the **OK** Button.

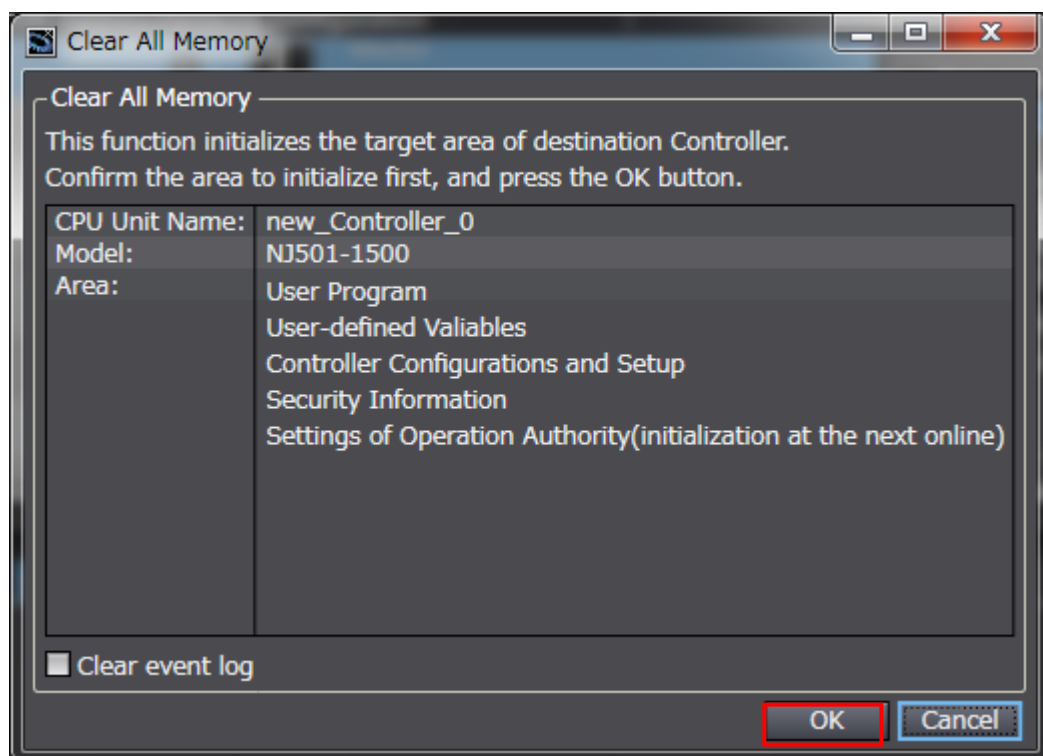

8.2. Initializing the FH Sensor Controller

For how to initialize the FH Sensor Controller, refer to *Initializing the Controller* in *Section 1 Before Operation of the Vision Sensor FH/FZ5 Series Vision System User's Manual* (Cat.No.Z340).

9. Revision History

Revision code	Date of revision	Revision reason and revision page
01	Nov. 26, 2013	First edition

OMRON Corporation Industrial Automation Company

Tokyo, JAPAN

Contact: www.ia.omron.com

Regional Headquarters

OMRON EUROPE B.V.

Wegalaan 67-69-2132 JD Hoofddorp
The Netherlands

Tel: (31)2356-81-300/Fax: (31)2356-81-388

OMRON ELECTRONICS LLC

One Commerce Drive Schaumburg,
IL 60173-5302 U.S.A.

Tel: (1) 847-843-7900/Fax: (1) 847-843-7787

OMRON ASIA PACIFIC PTE. LTD.

No. 438A Alexandra Road # 05-05/08 (Lobby 2),
Alexandra Technopark,
Singapore 119967

Tel: (65) 6835-3011/Fax: (65) 6835-2711

OMRON (CHINA) CO., LTD.

Room 2211, Bank of China Tower,
200 Yin Cheng Zhong Road,
PuDong New Area, Shanghai, 200120, China

Tel: (86) 21-5037-2222/Fax: (86) 21-5037-2200

Authorized Distributor:

© OMRON Corporation 2013 All Rights Reserved.
In the interest of product improvement,
specifications are subject to change without notice.

Cat. No. P577-E1-01

1113(-)