

Programmable Multi-Axis Controller

Startup Guide for DirectPWM Interface

CK3W-AX1313 □

CK3W-AX2323 □

**Startup
Guide**

NOTE

1. All rights reserved. No part of this publication may be reproduced, stored in a retrieval system, or transmitted, in any form, or by any means, mechanical, electronic, photocopying, recording, or otherwise, without the prior written permission of OMRON.
2. No patent liability is assumed with respect to the use of the information contained herein.
Moreover, because OMRON is constantly striving to improve its high-quality products, the information contained in this manual is subject to change without notice.
3. Every precaution has been taken in the preparation of this manual. Nevertheless, OMRON assumes no responsibility for errors or omissions.
Neither is any liability assumed for damages resulting from the use of the information contained in this publication.

Trademarks

- Microsoft, Windows, Excel, Visual Basic, and Microsoft Edge are either registered trademarks or trademarks of Microsoft Corporation in the United States and other countries.
- EtherCAT® is registered trademark and patented technology, licensed by Beckhoff Automation GmbH, Germany.

Other company names and product names in this document are the trademarks or registered trademarks of their respective companies.

Copyrights

- Microsoft product screen shots used with permission from Microsoft.
- This product incorporates certain third party software. The license and copyright information associated with this software is available at http://www.fa.omron.co.jp/nj_info_e/.

Sections in this Manual

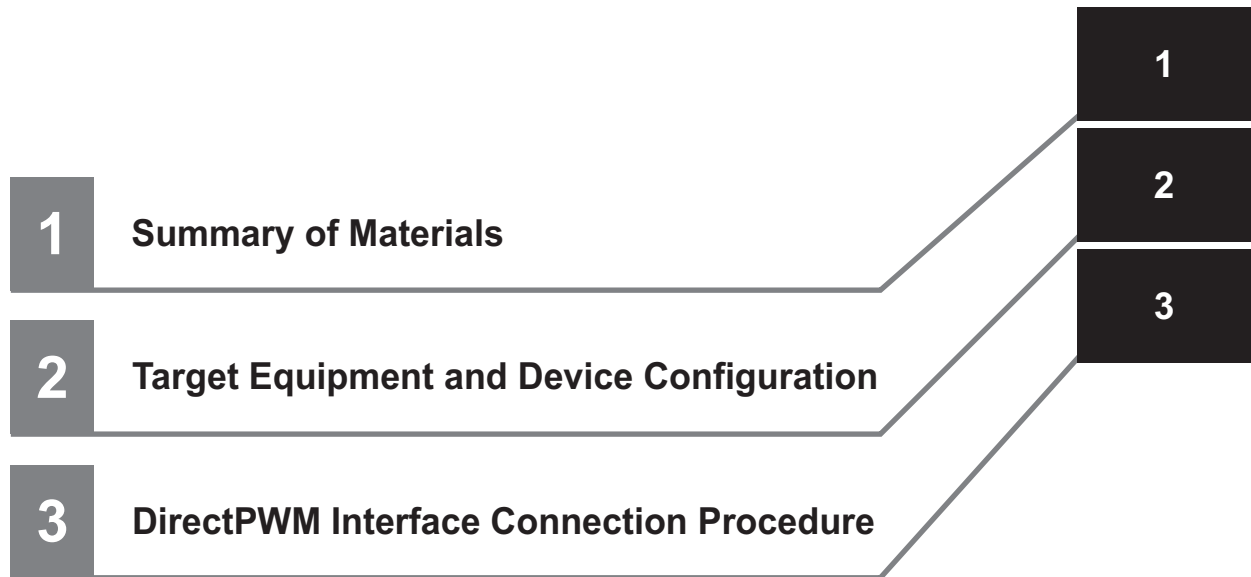

CONTENTS

Sections in this Manual	3
Precautions	5
Related Manuals.....	6
Terms and Definitions.....	7
Revision History.....	8

Section 1 About This Guide

1-1 Introduction	1-2
1-1-1 Intended Audience	1-2

Section 2 Target Equipment and Device Configuration

2-1 Device Configuration.....	2-2
--------------------------------------	------------

Section 3 DirectPWM Interface Connection Procedure

3-1 Work Flow.....	3-2
3-2 Controller Setting Preparations.....	3-3
3-2-1 Creation of a New Project	3-3
3-2-2 Controller Initial Setting	3-4
3-3 Connecting Devices.....	3-6
3-4 Various Controller Settings.....	3-8
3-4-1 List of Notes	3-14
3-5 Confirmation of Settings	3-17
3-6 Motor Tuning	3-19
3-6-1 Open Loop Test.....	3-19
3-6-2 Current Loop Gain Setting	3-20
3-6-3 Bandwidth Automatic Setting	3-21
3-6-4 Manual Setting of Bandwidth	3-23
3-6-5 Feed-Forward Value Setting.....	3-25
3-6-6 Checking of Operation and Creation of Tuning Parameter Project	3-27

Precautions

- For actual system construction, check the specifications for each device and piece of equipment that makes up the system, use a method with sufficient margin for ratings and performance, and adopt safety circuits and other safety measures to minimize risks even if a breakdown occurs.
- To safely utilize the system, obtain a manual or user's guide for each device and piece of equipment that makes up the system, confirm and understand their content, including "Safety Precautions", "Precautions for Safe Use", and other precautions related to safety, and then proceed with use.
- The customer must check all regulations, laws, and rules that are applicable to the system themselves.
- Copying, duplication, or redistribution of part or all of these materials without the permission of OMRON Corporation is prohibited.
- The content listed in these materials may be changed without notice for purposes of improvement.

The marks used in these materials are defined as follows.



Precautions for Correct Use

Precautions on what to do and what not to do to ensure correct operation and performance.



Additional Information

Additional information to read as required.

This information is provided to increase understanding and make operation easier.

Related Manuals

To safely utilize the system, obtain a manual or user's guide for each device and piece of equipment, confirm their content, including "Safety Precautions", "Precautions for Safe Use", and other precautions related to safety, and then proceed with use.

The manuals for OMRON Corporation (hereafter, "OMRON") and Delta Tau Data Systems Inc. (hereafter "DT") are as shown below.

Manufacturer	Cat. No.	Model	Manual Name
OMRON	O036	CK5M-□ CK3M-□ CK3W-□	Programmable Multi-Axis Controller Hardware User's Manual
DT	O014	---	Power PMAC User's Manual
DT	O015	---	Power PMAC Software Reference Manual
DT	O016	---	Power PMAC IDE User's Manual

Terms and Definitions

Terms	Descriptions and Definitions
PMAC	This is the acronym for Programmable Multi-Axis Controller.
Power PMAC IDE	This is computer software that is used to configure the Motion Controller, create user programs, and perform monitoring.
DirectPWM	This is a proprietary interface method developed by Delta Tau Data Systems, Inc. for connecting Servo Drives.
Digital Quadrature Encoder	This is a type of encoder that outputs pulse signals.

Revision History

A manual revision code appears as a suffix to the catalog number on the front and back covers.

Cat. No.	O047-E1-02
-----------------	-------------------

↑
Revision code

Revision code	Revision date	Revised content
01	July 2019	Original production
02	January 2023	<ul style="list-style-type: none">• Revision due to change of applicable Servo Drives• Corrected mistakes.



About This Guide

This section lists a summary of these materials.

1-1	Introduction	1-2
1-1-1	Intended Audience	1-2

1-1 Introduction

This document describes the connecting procedure and confirmation for an OMRON Programmable Multi-Axis Controller CK□M-□□□□ (hereinafter referred to as "Controller") and a DirectPWM interface-capable Servo Drive.

By understanding the setting content and setting procedure points described in *Section 3 DirectPWM Interface Connection Procedure* on page 3-1, you can configure the Controller to send commands to the DirectPWM interface-capable Servo Drive and control Servomotors.

The connection procedure in this document describes an example when a digital quadrature encoder is used to perform position and velocity feedback for CK3W-AX1313□. *1

*1. If CK3W-AX2323□ is used, the same DirectPWM interface as CK3W-AX1313□ is available but the encoder setting needs to be changed because a different type of encoder needs to be connected. Refer to the following documents for encoder settings.

- *Startup Guide Sinusoidal Encoder*
- *Startup Guide for SSI/Mitutoyo/EnDat 2.1/2.2 Serial Encoder*

1-1-1 Intended Audience

This guide is intended for the following personnel, who must also have knowledge of electrical systems (electrical or the equivalent).

- Personnel in charge of introducing FA systems.
- Personnel in charge of designing FA systems.
- Personnel in charge of installing and maintaining FA systems.
- Personnel in charge of managing FA systems and facilities.

Also, this guide is intended for personnel who understand the contents described in the DT manual.

2

Target Equipment and Device Configuration

This section lists the target equipment and system configurations for connections in these materials.

2-1	Device Configuration	2-2
------------	-----------------------------------	------------

2-1 Device Configuration

The configuration devices for reproducing the connection procedures in this document are shown below.

This example shows a DirectPWM interface setting using the configuration where the digital quadrature encoder is connected to the output axis of a motor. This configuration is used only to show a setting example and is not a standard configuration.

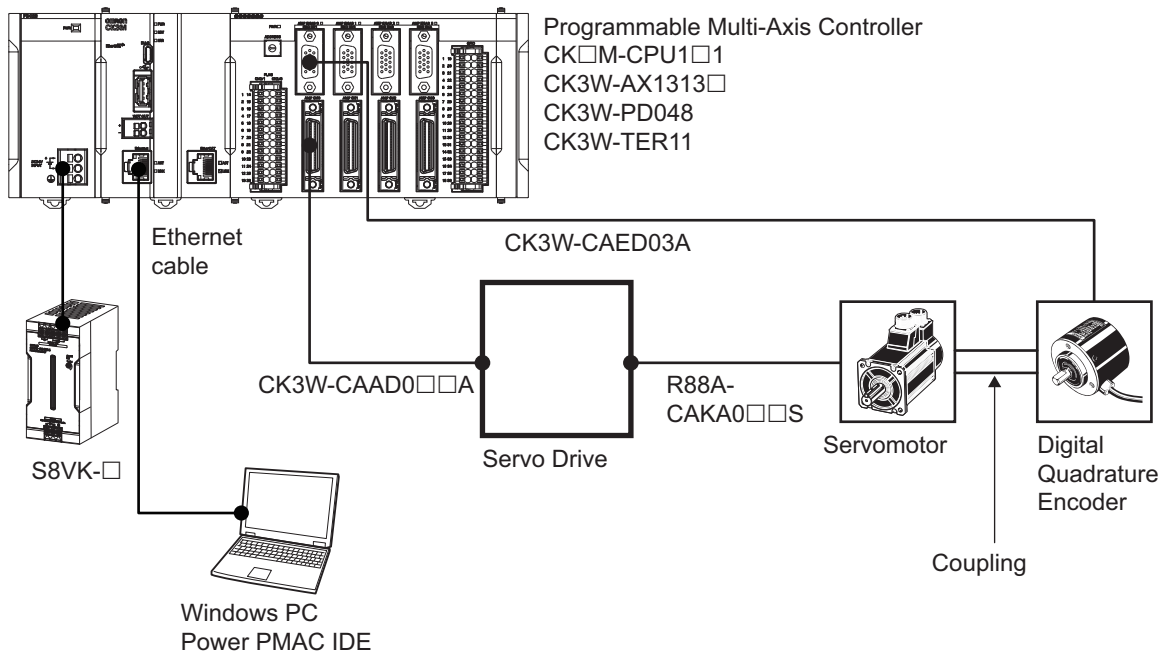

Precautions for Correct Use

Always secure a Servomotor and encoder. Starting the motor that is not secured leads to a failure.

Manufacturer	Name	Model	Version
OMRON	Programmable Multi-Axis Controller CPU Unit	CK□M-CPU1□1	Version 2.5.2 or later
OMRON	Programmable Multi-Axis Controller Axis Interface Unit	CK3W-AX1313□	---
OMRON	Programmable Multi-Axis Controller Power Supply Unit	CK3W-PD048	---
OMRON	Programmable Multi-Axis Controller End Cover	CK3W-TER11	---
OMRON	DirectPWM Cable	CK3W-CAAD0□□A	---
OMRON	Motor Cable	R88A-CAKA0□□S	---
OMRON	Encoder Cable	CK3W-CAES03A	---
OMRON	Servo Drive	CK3A-G310L	---
OMRON	Servomotor	R88M-K05030T	---
OMRON	Digital Quadrature Encoder	E6B2-CWZ1X	---
OMRON	Coupling	E69-C68B	---
OMRON	Switching Power Supply	S8VK-□	---

Manufacturer	Name	Model	Version
---	Windows PC	---	---
DT	Power PMAC Setting Tool	Power PMAC IDE	Version 4.3 or later

3

DirectPWM Interface Connection Procedure

This section describes the procedures for connecting the Controller and Servo Drive, and operating the motion control equipment with the DirectPWM interface. The description assumes that the Controller is set to factory default.

3-1	Work Flow	3-2
3-2	Controller Setting Preparations	3-3
3-2-1	Creation of a New Project	3-3
3-2-2	Controller Initial Setting	3-4
3-3	Connecting Devices	3-6
3-4	Various Controller Settings	3-8
3-4-1	List of Notes	3-14
3-5	Confirmation of Settings	3-17
3-6	Motor Tuning.....	3-19
3-6-1	Open Loop Test	3-19
3-6-2	Current Loop Gain Setting.....	3-20
3-6-3	Bandwidth Automatic Setting	3-21
3-6-4	Manual Setting of Bandwidth.....	3-23
3-6-5	Feed-Forward Value Setting.....	3-25
3-6-6	Checking of Operation and Creation of Tuning Parameter Project	3-27

3-1 Work Flow

The procedures for connecting the Controller and Servo Drive, and operating the motion control equipment with the DirectPWM interface, are shown below.

3-2 Controller Setting Preparations on page 3-3	Perform the Controller setting preparations.
▼	
3-2-1 Creation of a New Project on page 3-3	
▼	
3-2-2 Controller Initial Setting on page 3-4	
▼	
3-3 Connecting Devices on page 3-6	Perform connection and wiring for each device.
▼	
3-4 Various Controller Settings on page 3-8	Perform the Controller settings.
▼	
3-5 Confirmation of Settings on page 3-17	Check that the settings up to here are correct.
▼	
3-6 Motor Tuning on page 3-19	Use Power PMAC IDE tuning tools to tune the motor.
▼	
3-6-1 Open Loop Test on page 3-19	
▼	
3-6-2 Current Loop Gain Setting on page 3-20	
▼	
3-6-3 Bandwidth Automatic Setting on page 3-21	
▼	
3-6-4 Manual Setting of Bandwidth on page 3-23	
▼	
3-6-5 Feed-Forward Value Setting on page 3-25	
▼	
3-6-6 Checking of Operation and Creation of Tuning Parameter Project on page 3-27	

3-2 Controller Setting Preparations

Perform the Controller setting preparations.
Install the Power PMAC IDE on the PC beforehand.

3-2-1 Creation of a New Project

Follow the procedure below to create a new project.

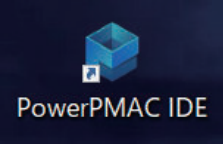
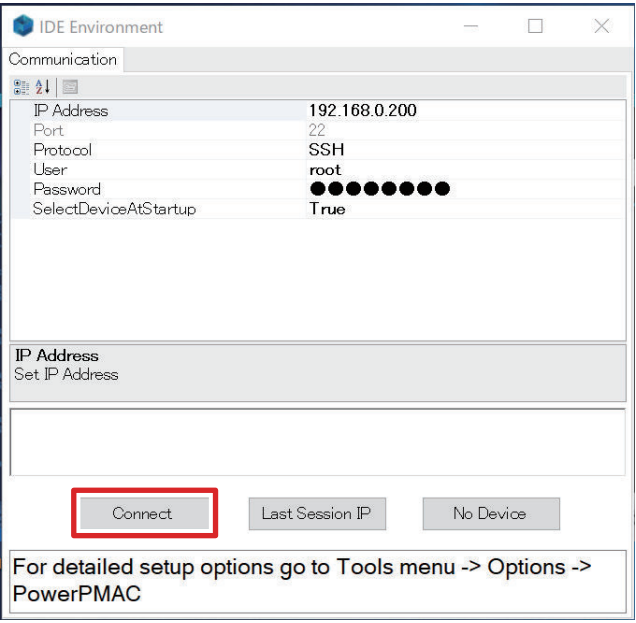
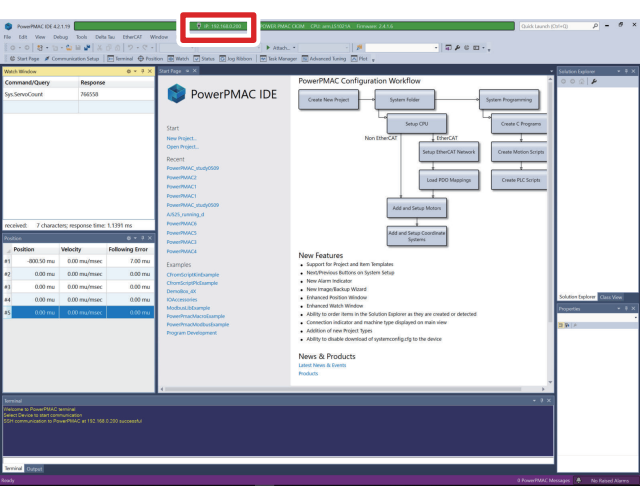
1	Connect the Controller and computer with an Ethernet cable.	
2	Turn ON the power supply to the Controller.	
3	Start up Power PMAC IDE. <ul style="list-style-type: none"> If a dialog for checking access rights is displayed at the time of startup, select the option for starting up. 	
4	The Communication screen is displayed, so specify the IP address of the Controller to be connected to, and click the Connect button. <ul style="list-style-type: none"> The default IP address for the Controller is "192.168.0.200". If necessary, change the Windows IP address to "192.168.0.X". 	 <p>For detailed setup options go to Tools menu -> Options -> PowerPMAC</p>
5	Power PMAC IDE starts up, and the Controller will come online.	

6 From the **File** menu, select **New – Project**.

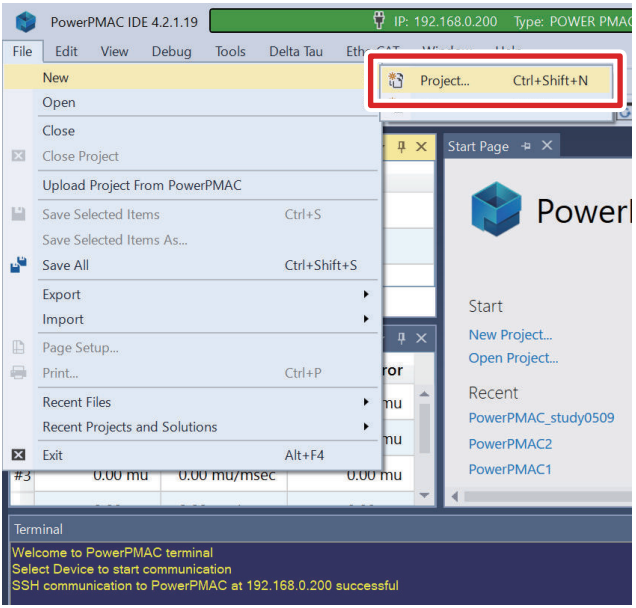

7 Input a project name and save destination, and select the **OK** button.

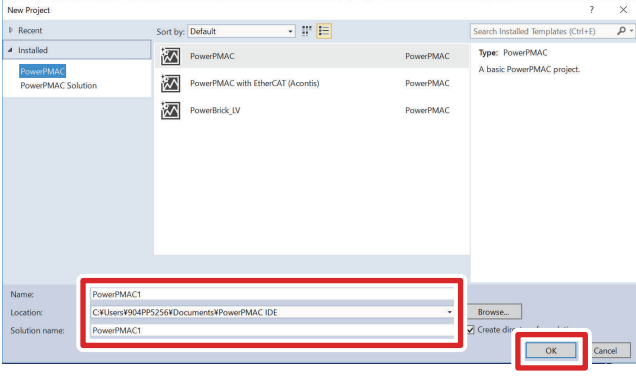

3-2-2 Controller Initial Setting

Follow the procedure below to perform the initial settings for the Controller.



Precautions for Correct Use

Since all memory is cleared by the initial settings, be sure to save any data remaining in the Controller that you may need.

1 Type the **\$\$\$***** command from the Terminal, and set the Controller to the factory default state.

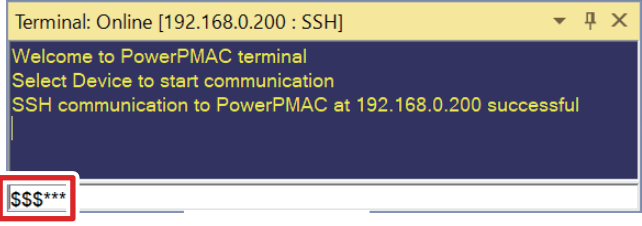

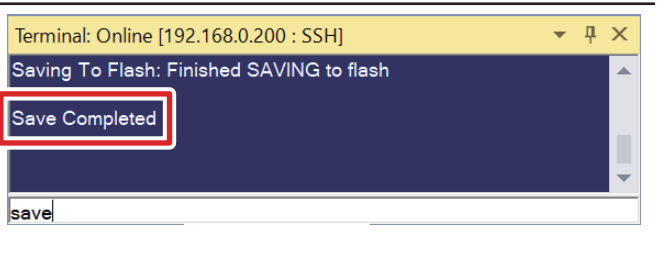
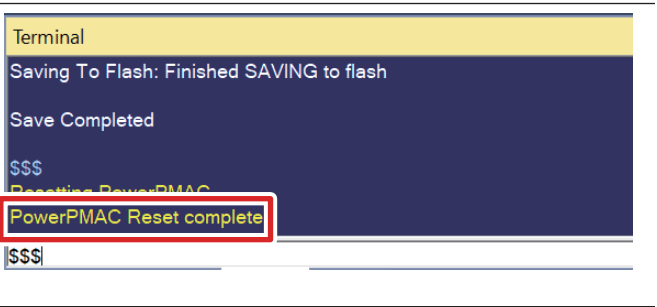
<p>2</p>	<p>Type the save command in the Power PMAC IDE Terminal.</p> <ul style="list-style-type: none"> When the save is completed, "Save Completed" is displayed in the Terminal. 	 <p>A terminal window titled "Terminal: Online [192.168.0.200 : SSH]" with a yellow header bar. The main area is dark blue with white text. It shows "Saving To Flash: Finished SAVING to flash" followed by "Save Completed" which is highlighted with a red rectangular box. Below this, the command "save" is entered at the prompt.</p>
<p>3</p>	<p>Type the \$\$\$ command in the Power PMAC IDE Terminal.</p> <ul style="list-style-type: none"> When the reset is completed, "PowerPMAC Reset complete" is displayed in the Terminal. 	 <p>A terminal window titled "Terminal" with a yellow header bar. The main area is dark blue with white text. It shows "Saving To Flash: Finished SAVING to flash" followed by "Save Completed". Then, the command "\$\$\$" is entered, followed by "Resetting PowerPMAC" and "PowerPMAC Reset complete" which is highlighted with a red rectangular box. Below this, the command "\$\$\$" is entered at the prompt.</p>

3-3 Connecting Devices

The following diagram shows the connection between the axis interface unit and various equipment.

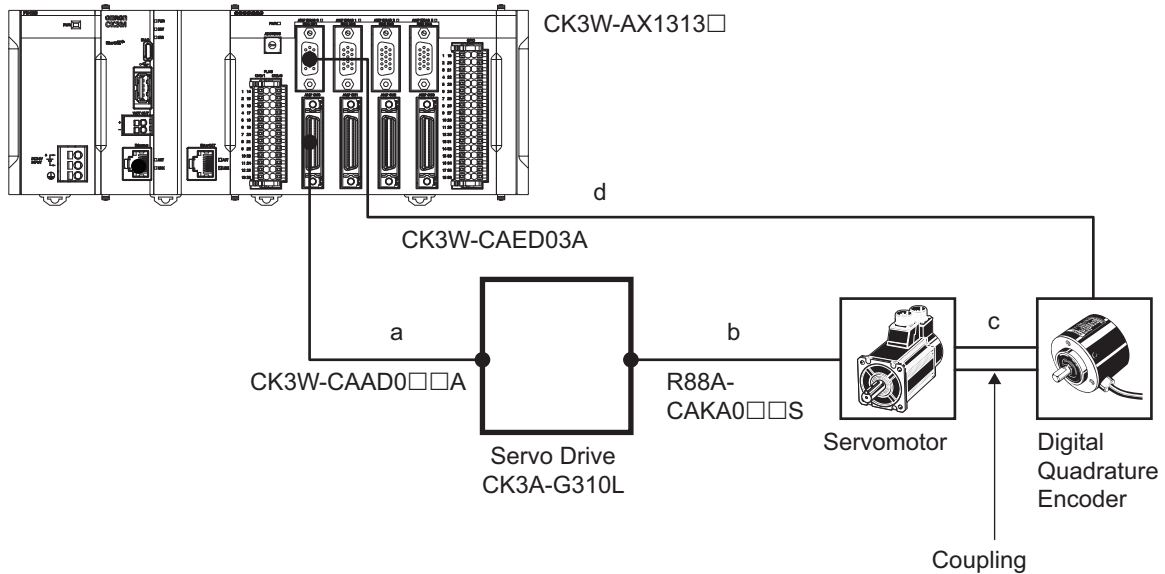

Follow the instructions below to connect a, b, c, and d shown in the diagram above.

a. Connection between the Controller and Servo Drive

Use the following dedicated cables to connect the CK3W-AX1313□ amplifier connector to the Servo Drive C2 connector.

Manufacturer	Name	Model	Length
OMRON	DirectPWM Cable	CK3W-CAAD009A	0.9 m
		CK3W-CAAD018A	1.8 m
		CK3W-CAAD036A	3.6 m

b. Connection between the Servo Drive and Servomotor

Use the following dedicated cables to connect the Servo Drive P2 connector to the Servomotor connector.

Manufacturer	Name	Model	Length
OMRON	Motor Cable	R88A-CAKA003S	3 m
		R88A-CAKA005S	5 m
		R88A-CAKA010S	10 m
		R88A-CAKA015S	15 m
		R88A-CAKA020S	20 m
		R88A-CAKA030S	30 m
		R88A-CAKA040S	40 m
		R88A-CAKA050S	50 m

c. Connection between the Servomotor and Encoder

Use the following coupling to connect the rotary axes of the Servomotor and digital quadrature encoder.

Coupling: E69-C68B

d. Wiring between the Controller and Encoder

Use the following dedicated cable to connect CK3W-AX1313□ to the digital quadrature encoder.

Manufacturer	Name	Model	Length
OMRON	Encoder Cable	CK3W-CAES03A	3 m

Follow the wiring diagram below to connect the dedicated cable (CK3W-CAES03A) to the digital quadrature encoder.

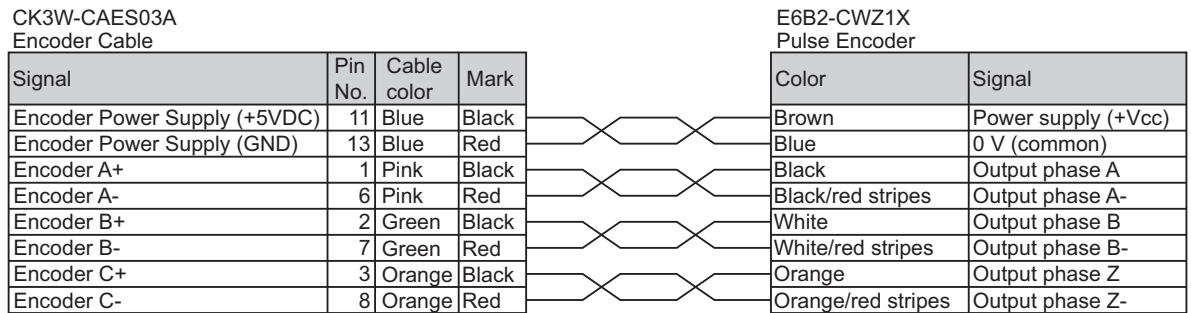

3-4 Various Controller Settings

Perform the settings for the Controller to control the servomotor using the DirectPWM interface and digital quadrature encoder according to the following procedure.



Precautions for Correct Use

- For items to be written in the global definitions.pmh in step 2 in the following procedure, set appropriate values depending on the motor and Servo Drive used. If the set value is not appropriate, an excessive current flows, which may cause the equipment to fail. Refer to Notes *24 through *26 in 3-4-1 List of Notes on page 3-14 for the settings.
- If **Motor[1].IaBias** and **Motor[1].IbBias** are set to other than 0 in the following step 9 and 11, the motor may rotate. Make sure that no problem occurs and the equipment is safe if the motor rotates before the setting.

1 Open the global definitions.pmh under **PMAC Script Language – Global Includes** in the Solution Explorer.

2 Write the text on the right to the global definitions.pmh.

- Refer to 3-4-1 *List of Notes* on page 3-14 for details on setting items with Notes *1 through *30 shown in the text on the right.

```

Sys.WpKey = $AAAAAAAA

//global setting
Gate3[0].PhaseServoDir = 0;
Gate3[0].PhaseFreq = 10000; //10kHz
Gate3[0].ServoClockDiv = 9; //1kHz
Sys.PhaseOverServoPeriod = 0.1;
Sys.ServoPeriod = 1;

//Encoder Setting
EncTable[1].Type = 1; // *1
EncTable[1].pEnc = Gate3[0].Chan[0].ServoCapt
.a; // *2
EncTable[1].ScaleFactor = 1/exp2(8); // *3
Gate3[0].EncClockDiv = 5; //3.125MHz
Gate3[0].Chan[0].EncCtrl = 7; // *4

//DirectPWM AD Convertor setting
Gate3[0].AdcAmpStrobe = $901001; // *5
Gate3[0].AdcAmpHeaderBits = 4; // *6
Gate3[0].AdcAmpClockDiv = 5; //3.125MHz

//DirectPWM PWM output setting
Gate3[0].Chan[0].PwmFreqMult = 2; // *7
Gate3[0].Chan[0].PwmDeadTime = 3.1 / 0.0533;
// *8
Gate3[0].Chan[0].PackInData = 0; // *9
Gate3[0].Chan[0].PackOutData = 0; // *10

```

```

Sys.WpKey=$0

//Motor setting
Motor[1].ServoCtrl = 1; //Enable the Motor[1]
.
Motor[1].PhaseCtrl = 1; //Enable the commutator task.
Motor[1].pPhaseEnc = Gate3[0].Chan[0].PhaseCapt.a; /*11
Motor[1].PhasePosSf = 2048/(256*2000*4/5); /*12
Motor[1].PwmSf = 13458; /*13
Motor[1].PhaseOffset = 683; /*14
Motor[1].AmpFaultLevel = 1; /*15
Motor[1].pLimits = 0; //Disable the Overtravel limit.
Motor[1].WarnFeLimit = 4000; /*16
Motor[1].FatalFeLimit = 8000; /*17
Motor[1].pAmpEnable = Gate3[0].Chan[0].OutCtrl.a;
Motor[1].pAmpFault = Gate3[0].Chan[0].Status.a;
Motor[1].pCaptFlag = Gate3[0].Chan[0].Status.a;
Motor[1].pCaptPos = Gate3[0].Chan[0].HomeCapt.a;
Motor[1].pEncCtrl = Gate3[0].Chan[0].OutCtrl.a;
Motor[1].pEncStatus = Gate3[0].Chan[0].Status.a;
Motor[1].pMasterEnc = EncTable[1].a;
Motor[1].CurrentNullPeriod = 0; /*18
Motor[1].pEnc = EncTable[1].a /*19
Motor[1].pEnc2 = EncTable[1].a /*20
Motor[1].pDac = Gate3[0].Chan[0].Pwm[0].a; /*21
Motor[1].pAdc = Gate3[0].Chan[0].AdcAmp[0].a; /*22
Motor[1].AdcMask = $FFFF0000; /*23
Motor[1].MaxDac = 28377 * 3.33 / 16.25; /*24
Motor[1].I2tSet = 28377 * 1.1 / 16.25; /*25
Motor[1].I2tTrip = (Motor[1].MaxDac * Motor[1].MaxDac - Motor[1].I2tSet * Motor[1].I2tSet) * 3; /*26
Motor[1].AbsPhasePosOffset = 400; /*27
Motor[1].PhaseFindingDac = 400; /*28
Motor[1].PhaseFindingTime = 1000; /*29
Motor[1].PowerOnMode=0; /*30
Motor[1].InPosBand = 100;

// Setting Coordinate System
&1
#1->x
&1%100;

```

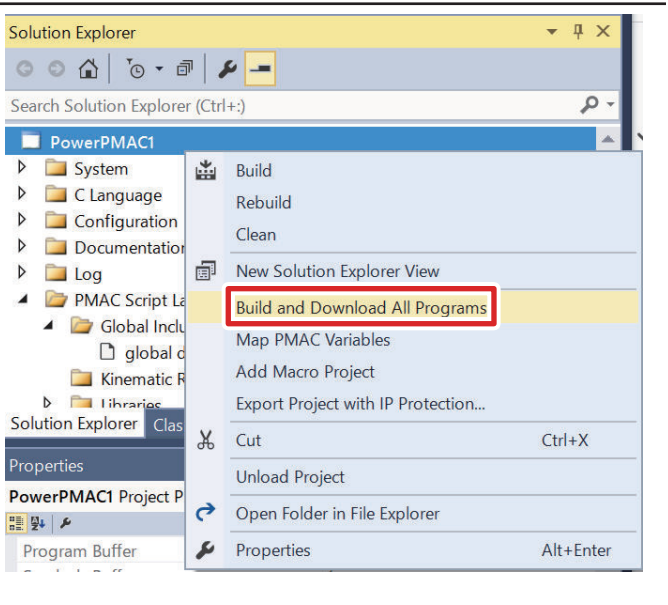
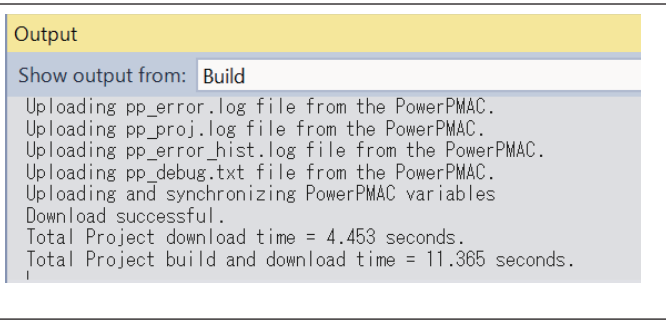
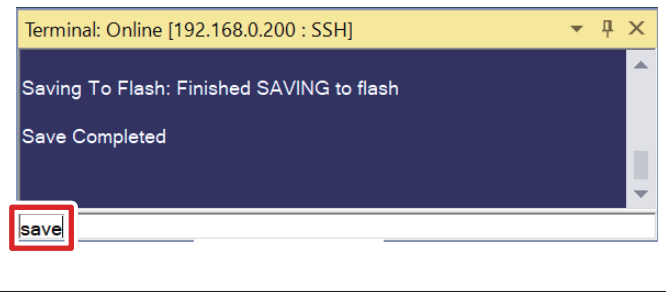
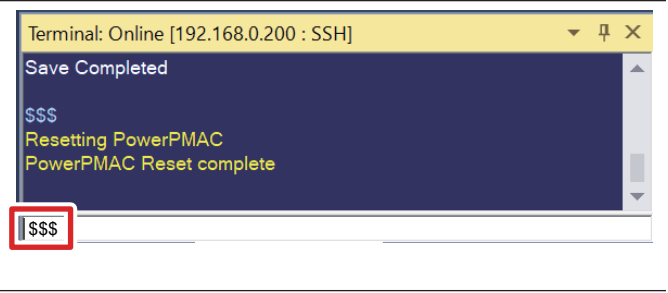
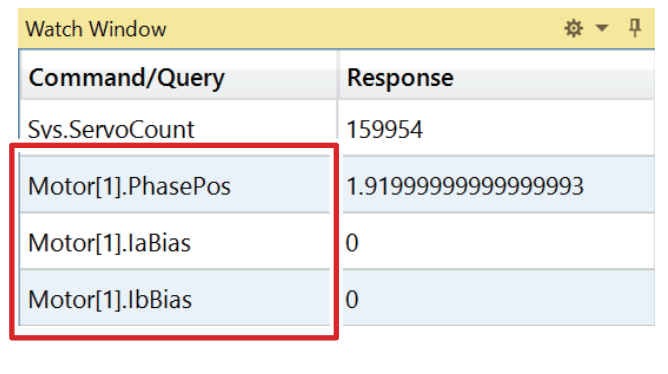
<p>3</p>	<p>Right click on the Solution Explorer project name at the upper right of the Power PMAC IDE screen, select Build and Download All Programs, and execute Build and Download.</p>											
<p>4</p>	<p>Make sure that there are no errors in the Output Window.</p> <ul style="list-style-type: none"> If the transfer failed, check the content of the error in the Output Window. If there is a program error, fix the program. 											
<p>5</p>	<p>Type the save command in the Power PMAC IDE Terminal.</p> <ul style="list-style-type: none"> When the save is completed, "Save Completed" is displayed in the Terminal. 											
<p>6</p>	<p>Type the \$\$\$ command in the Terminal.</p>											
<p>7</p>	<p>To determine a sign for Motor[1].PhaseOffset, paste Motor[1].PhasePos, Motor[1].IaBias, and Motor[1].IbBias in the Watch window.</p>	 <table border="1"> <thead> <tr> <th>Command/Query</th> <th>Response</th> </tr> </thead> <tbody> <tr> <td>Svs.ServoCount</td> <td>159954</td> </tr> <tr> <td>Motor[1].PhasePos</td> <td>1.9199999999999993</td> </tr> <tr> <td>Motor[1].IaBias</td> <td>0</td> </tr> <tr> <td>Motor[1].IbBias</td> <td>0</td> </tr> </tbody> </table>	Command/Query	Response	Svs.ServoCount	159954	Motor[1].PhasePos	1.9199999999999993	Motor[1].IaBias	0	Motor[1].IbBias	0
Command/Query	Response											
Svs.ServoCount	159954											
Motor[1].PhasePos	1.9199999999999993											
Motor[1].IaBias	0											
Motor[1].IbBias	0											

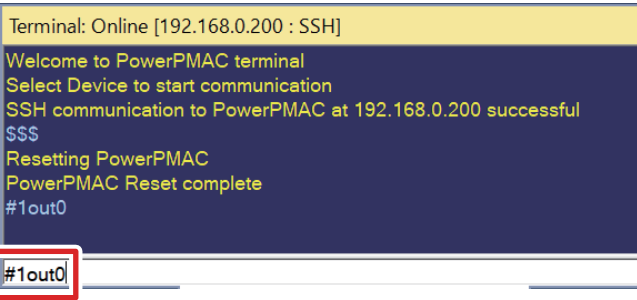
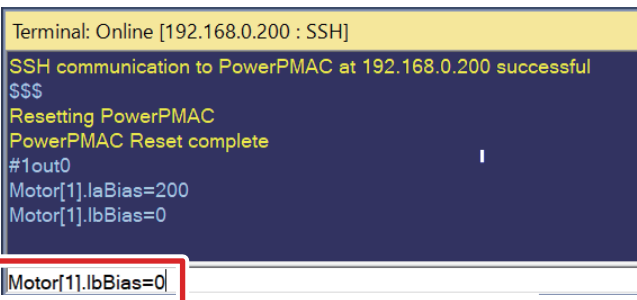
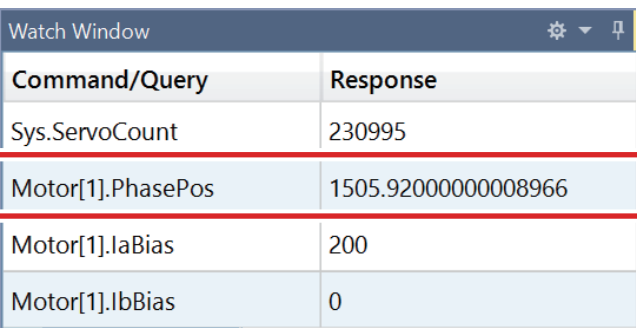
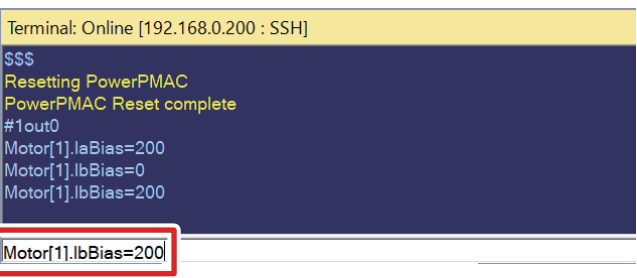
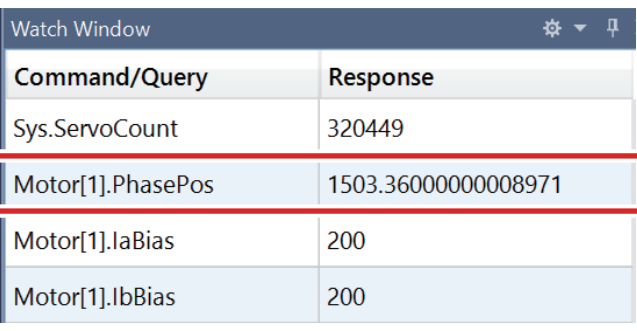
<p>8</p>	<p>Type the #1out0 command in the Terminal.</p>	 <pre>Terminal: Online [192.168.0.200 : SSH] Welcome to PowerPMAC terminal Select Device to start communication SSH communication to PowerPMAC at 192.168.0.200 successful \$\$\$ Resetting PowerPMAC PowerPMAC Reset complete #1out0</pre>										
<p>9</p>	<p>Set Motor[1].IaBias=200 and Motor[1].IbBias=0 in the Terminal.</p>	 <pre>Terminal: Online [192.168.0.200 : SSH] SSH communication to PowerPMAC at 192.168.0.200 successful \$\$\$ Resetting PowerPMAC PowerPMAC Reset complete #1out0 Motor[1].IaBias=200 Motor[1].IbBias=0</pre>										
<p>10</p>	<p>Check the Motor[1].PhasePos value in the Watch window.</p>	 <table border="1"> <thead> <tr> <th>Command/Query</th> <th>Response</th> </tr> </thead> <tbody> <tr> <td>Sys.ServoCount</td> <td>230995</td> </tr> <tr> <td>Motor[1].PhasePos</td> <td>1505.92000000008966</td> </tr> <tr> <td>Motor[1].IaBias</td> <td>200</td> </tr> <tr> <td>Motor[1].IbBias</td> <td>0</td> </tr> </tbody> </table>	Command/Query	Response	Sys.ServoCount	230995	Motor[1].PhasePos	1505.92000000008966	Motor[1].IaBias	200	Motor[1].IbBias	0
Command/Query	Response											
Sys.ServoCount	230995											
Motor[1].PhasePos	1505.92000000008966											
Motor[1].IaBias	200											
Motor[1].IbBias	0											
<p>11</p>	<p>Set Motor[1].IbBias=200 in the Terminal.</p> <ul style="list-style-type: none"> • Motor[1].IaBias remains 200. 	 <pre>Terminal: Online [192.168.0.200 : SSH] \$\$\$ Resetting PowerPMAC PowerPMAC Reset complete #1out0 Motor[1].IaBias=200 Motor[1].IbBias=0 Motor[1].IbBias=200</pre>										
<p>12</p>	<p>Check the Motor[1].PhasePos value in the Watch window.</p>	 <table border="1"> <thead> <tr> <th>Command/Query</th> <th>Response</th> </tr> </thead> <tbody> <tr> <td>Sys.ServoCount</td> <td>320449</td> </tr> <tr> <td>Motor[1].PhasePos</td> <td>1503.36000000008971</td> </tr> <tr> <td>Motor[1].IaBias</td> <td>200</td> </tr> <tr> <td>Motor[1].IbBias</td> <td>200</td> </tr> </tbody> </table>	Command/Query	Response	Sys.ServoCount	320449	Motor[1].PhasePos	1503.36000000008971	Motor[1].IaBias	200	Motor[1].IbBias	200
Command/Query	Response											
Sys.ServoCount	320449											
Motor[1].PhasePos	1503.36000000008971											
Motor[1].IaBias	200											
Motor[1].IbBias	200											

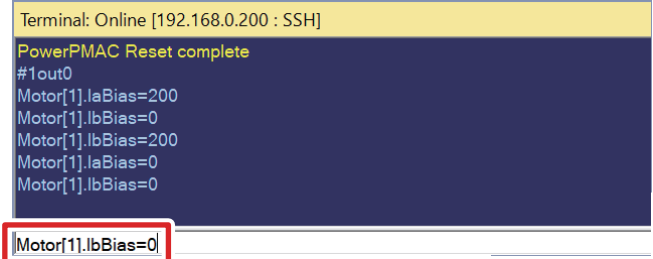
- 13** Type **Motor[1].IaBias=0** and **Motor[1].IbBias=0** in the Terminal to return the phase A and B bias currents to 0.
- 
- ```
Terminal: Online [192.168.0.200 : SSH]
PowerPMAC Reset complete
#1 out0
Motor[1].IaBias=200
Motor[1].IbBias=0
Motor[1].IbBias=200
Motor[1].IaBias=0
Motor[1].IbBias=0
Motor[1].IbBias=0
```
- 14** If the **Motor[1].PhasePos** value decreases when values in step 10 and 12 are compared, set the sign of **Motor[1].PhaseOffset** to + (addition); if the value increases, set the sign to - (subtraction).
- Since the value decreases in this example, set **Motor[1].PhaseOffset=683** in the global definitions.pmh. If a sign of **Motor[1].PhaseOffset** needs to be changed, change the sign in the global definitions.pmh and perform download again following the procedure in step 3 through 6.
- 15** Manually rotate the coupling that connects the motor to encoder and check that the desired scale is applied to the current position in the Position window.
- The **EncTable[1].ScaleFactor** value is set to 8000 counts per rotation in this example, so 8000 mu is added to the current position per rotation.
  - Because the number of pairs of magnetic poles is 5, **Motor[1].PhasePos** is set to count from 0 up to 2047.9999 5 times per motor revolution. While rotating the motor one time, check **Motor[1].PhasePos** in the Watch Window.
- | Position |           |
|----------|-----------|
| Position |           |
| #1       | 632.00 mu |
| #2       | 0.00 mu   |
| #3       | 0.00 mu   |
| #4       | 0.00 mu   |



### Precautions for Correct Use

If the **save** command is not successfully completed, the transferred project is not saved in the Controller. If the power to the Controller is switched OFF without the project being saved, the transferred project is destroyed.



### Additional Information

To change the counting direction of the digital quadrature encoder (clockwise/counterclockwise), change the sign of the following set values to write in the global definitions.pmh in step 2 to - (subtraction).

- EncTable[1].ScaleFactor
- Motor[1].PhasePosSf

### 3-4-1 List of Notes

The following table shows details on notes (description of set items) in step 2.



| No. | Set item                     | Set value                    | Description                                                                                                                                                                                                                                                                                                                                                                            |
|-----|------------------------------|------------------------------|----------------------------------------------------------------------------------------------------------------------------------------------------------------------------------------------------------------------------------------------------------------------------------------------------------------------------------------------------------------------------------------|
| *1  | EncTable[1].Type             | 1                            | Enable EncTable[1] as single-word (32 bits) read.                                                                                                                                                                                                                                                                                                                                      |
| *2  | EncTable[1].pEnc             | Gate3[0].Chan[0].ServoCapt.a | Assign the digital quadrature encoder data to EncTable[1].                                                                                                                                                                                                                                                                                                                             |
| *3  | EncTable[1].Scale-Factor     | 1/exp2(8)                    | Calculate a scale factor set value in accordance with the following formula because EncTable[1] is 32 bits and Gate3[0].Chan[0].ServoCapt (digital quadrature encoder data) is 24 bits.<br><br>Set value : $\frac{1}{2^{(32 \text{ bits} - 24 \text{ bits})}}$                                                                                                                         |
| *4  | Gate3[0].Chan[0].EncCtrl     | 7                            | Set the digital quadrature encoder conversion method to four multiplication, counterclockwise.                                                                                                                                                                                                                                                                                         |
| *5  | Gate3[0].AdcAmpStrobe        | \$ffffc                      | Specify AMP Strobe Word. If \$ffffc is set, the Controller is compatible with all AD converters.                                                                                                                                                                                                                                                                                       |
| *6  | Gate3[0].AdcAmpHeaderBits    | 2                            | Set the header length of analog to digital conversion data to 2 bits. Set it depending on the Servo Drive specifications.                                                                                                                                                                                                                                                              |
| *7  | Gate3[0].Chan[0].PwmFreqMult | 2                            | Set the PWM frequency to 15 kHz. Calculate the PWM frequency in accordance with the formula below.<br><br>$f_{\text{PWM}} = \frac{\text{Gate3[0].Chan[0].PwmFreqMult} + 1}{2} \times f_{\text{IntPhase}}$<br>$f_{\text{IntPhase}}$ : Internal phase clock frequency<br><br>Make sure that the value is 40 kHz or less and the same as the Servo Drive maximum input frequency or less. |
| *8  | Gate3[0].Chan[0].PwmDeadTime | 3.1/0.0533                   | Set the dead time of the PWM signal to 3.1 $\mu\text{s}$ . Calculate the dead time with the following formula.<br>Dead time = 0.0533 $\mu\text{s}$ $\times$ Gate3[0].Chan[0].PwmDeadTime<br>Set it depending on the Servo Drive specifications.                                                                                                                                        |
| *9  | Gate3[0].Chan[0].PacInData   | 0                            | AdcAmp compression: Disabled<br>If the digital current loop is implemented, enable data compression that improves algorithm efficiency.<br>Disable it this time.                                                                                                                                                                                                                       |
| *10 | Gate3[0].Chan[0].PacOutData  | 0                            | Disable PWM/DAC compression.<br>If commutation and digital current loops are calculated, data compression improves the efficiency of the algorithm and should be enabled.<br>Disable it this time.                                                                                                                                                                                     |
| *11 | Motor[1].pPhaseEnc           | Gate3[0].Chan[0].PhaseCapt.a | Use the digital quadrature encoder for commutation position feedback.                                                                                                                                                                                                                                                                                                                  |

| No. | Set item                    | Set value                    | Description                                                                                                                                                                                                                                                                                                                                                                                                                                                                                                                                                                                                                                                                                                                                                    |
|-----|-----------------------------|------------------------------|----------------------------------------------------------------------------------------------------------------------------------------------------------------------------------------------------------------------------------------------------------------------------------------------------------------------------------------------------------------------------------------------------------------------------------------------------------------------------------------------------------------------------------------------------------------------------------------------------------------------------------------------------------------------------------------------------------------------------------------------------------------|
| *12 | Motor[1].Phase-PosSf        | 2048/<br>(256*2000*4/5)      | <p>Set a scale factor (Sf) of the commutation position (angle). Use the following formula to calculate the scale factor if 24 bits digital quadrature encoder (Gate3[0].Chan[0].ServoCapt) is assigned to 32 bits EncTable[1] as this example.</p> $Sf = \frac{2048 \times \text{Number of motor pole pairs}}{256 \times \text{Encoder resolution} \times \text{Encoder multiplication setting}}$ <p>Set it depending on the specifications of equipment used.<br/>The following shows parameters for equipment used in this example.<br/>256: <math>2^{(32 \text{ bits} - 24 \text{ bits})} = 256</math><br/>Encoder resolution: 2000 pulses per rotation<br/>Encoder multiplication: 4 multiplication<br/>Number of motor pole pairs: 5 pairs (10 poles)</p> |
| *13 | Motor[1].PwmSf              | 13458                        | <p>Set a scale factor for PWM output. The full range is 16384.<br/>The scale factor is normally set to less than 95% of the full range so that PWM waveform cannot reach the duty cycle of 0% or 100%. It is set to approximately 82% in this example.<br/>Set it depending on the Servo Drive specifications.</p>                                                                                                                                                                                                                                                                                                                                                                                                                                             |
| *14 | Motor[1].PhaseOffset        | 683                          | For a three-phase motor, set to 683 or -683.                                                                                                                                                                                                                                                                                                                                                                                                                                                                                                                                                                                                                                                                                                                   |
| *15 | Motor[1].AmpFaultLevel      | 1                            | <p>Specify a logic of AMP Fault detection. Set it depending on the Servo Drive specifications.<br/>0: Negative logic is used to detect AMP Fault.<br/>1: Positive logic is used to detect AMP Fault.</p>                                                                                                                                                                                                                                                                                                                                                                                                                                                                                                                                                       |
| *16 | Motor[1].WarnFeLimit        | 4000                         | <p>The status bit Motor[1].AmpWarn is set when the positional deviation exceeds this value.<br/>The value for a half-rotation of the motor is set in this example. Set it depending on applications used.</p>                                                                                                                                                                                                                                                                                                                                                                                                                                                                                                                                                  |
| *17 | Motor[1].FatalFeLimit       | 8000                         | <p>The motor is killed and the status bit Motor[1].FeFatal is set when the positional deviation exceeds this value.<br/>The value for a half-rotation of the motor is set in this example. Set it depending on applications used.</p>                                                                                                                                                                                                                                                                                                                                                                                                                                                                                                                          |
| *18 | Motor[1].Current-NullPeriod | 0                            | When the set value is 1, <b>Motor[1].IaBias</b> and <b>Motor[1].IbBias</b> are automatically set to <b>Motor[1].PhaseFindingStep=1</b> during phase search.                                                                                                                                                                                                                                                                                                                                                                                                                                                                                                                                                                                                    |
| *19 | Motor[1].pEnc               | EncTable[1].a                | <p>Specify the digital quadrature encoder as an address used for loop feedback to control the motor position.<br/>The digital quadrature encoder is assigned to EncTable[1] in Notes *2 in this example.</p>                                                                                                                                                                                                                                                                                                                                                                                                                                                                                                                                                   |
| *20 | Motor[1].pEnc2              | EncTable[1].a                | <p>Specify the digital quadrature encoder as the address used for loop feedback to control the motor velocity.<br/>The digital quadrature encoder is assigned to EncTable[1] in Notes *2 in this example.</p>                                                                                                                                                                                                                                                                                                                                                                                                                                                                                                                                                  |
| *21 | Motor[1].pDac               | Gate3[0].Chan[0].Pwm[0].a    | Assign DirectPWM to the motor command output register.                                                                                                                                                                                                                                                                                                                                                                                                                                                                                                                                                                                                                                                                                                         |
| *22 | Motor[1].pAdc               | Gate3[0].Chan[0].AdcAmp[0].a | Specify the DirectPWM interface AD converter as an AD converter used for digital current feedback.                                                                                                                                                                                                                                                                                                                                                                                                                                                                                                                                                                                                                                                             |
| *23 | Motor[1].AdcMask            | FFFFFF0000                   | <p>Specify which bit of 32 bits current feedback word is used as the actual current value.<br/>It is set for a 16-bit AD converter this time. Set it according to the specifications of the Servo Drive.</p>                                                                                                                                                                                                                                                                                                                                                                                                                                                                                                                                                   |

| No. | Set item                   | Set value                                                             | Description                                                                                                                                                                                                                                                                                                                                                                                                                                                                                                                                                                                                                                                                          |
|-----|----------------------------|-----------------------------------------------------------------------|--------------------------------------------------------------------------------------------------------------------------------------------------------------------------------------------------------------------------------------------------------------------------------------------------------------------------------------------------------------------------------------------------------------------------------------------------------------------------------------------------------------------------------------------------------------------------------------------------------------------------------------------------------------------------------------|
| *24 | Motor[1].MaxDac            | 28377*3.33/16.25                                                      | <p>Set an instantaneous current limit value (root mean square: RMS). Compare those of the Servo Drive and the motor, and use a smaller value. The motor has a smaller value in this example. Use the following formula for calculation.</p> $\text{MaxDac} = \frac{\text{Cos}(30^\circ) \times 32767 \times \text{Maximum instantaneous current}}{\text{Servo driver ADC full-range current}}$ <p>Determine parameters depending on the equipment used. The following shows parameters for equipment used in this example. Maximum instantaneous current for R88M-K05030T: 4.7 A (p-p)/<math>\sqrt{2}</math> = 3.33 A (RMS)<br/>CK3A-G310L ADC full range current: 16.25 A (RMS)</p> |
| *25 | Motor[1].I2tSet            | 28377*1.1/16.25                                                       | <p>Set a rated current limit value (RMS). Compare those of the Servo Drive and the motor, and use a smaller value. The motor has a smaller value in this example. Use the following formula for calculation.</p> $\text{I2tSet} = \frac{\text{Cos}(30^\circ) \times 32767 \times \text{Rated current}}{\text{Servo driver ADC full-range current}}$ <p>Determine parameters depending on the equipment used. The following shows parameters for equipment used in this example. Rated current for R88M-K05030T: 1.1 A (RMS)<br/>CK3A-G310L ADC full range current: 16.25 A (RMS)</p>                                                                                                 |
| *26 | Motor[1].I2tTrip           | (Motor[1].MaxDac*Motor[1].MaxDac - Motor[1].I2tSet*Motor[1].I2tSet)*3 | <p>Set a motor integrated current limit. Use the following formula for calculation.</p> $\text{I2tTrip} = (\text{MaxDAC}^2 + \text{IdCmd}^2 - \text{I2tSet}^2) \times \text{allowable time (second)}$ <p>Allowable time for R88M-K05030T: 3 seconds</p>                                                                                                                                                                                                                                                                                                                                                                                                                              |
| *27 | Motor[1].AbsPhasePosOffset | 400                                                                   | <p>Specify the minimum operation that is considered to be an efficient phase search. Although the commutation cycle (2048) 1/4 = 512 (90°) is ideal, it is set to approximately 80% in this example considering that problems such as friction can prevent the operation.</p> <p>If <b>Motor[1].PhaseFindingStep=1</b> displacement is smaller than this value during phase search, the phase search is considered to be failed by Power PMAC.</p>                                                                                                                                                                                                                                   |
| *28 | Motor[1].PhaseFindingDac   | 400                                                                   | <p>Set the size of phase-sequence current that is output to each motor phase in phase search. Adjust it depending on the equipment used.</p>                                                                                                                                                                                                                                                                                                                                                                                                                                                                                                                                         |
| *29 | Motor[1].PhaseFindingTime  | 1000                                                                  | <p>Set duration of each step during phase search. Adjust it depending on the equipment used.</p> <p>The following duration is used in this example.<br/>Duration = Servo cycle × Motor[1].PhaseFindingTime = 1 ms × 1000 = 1000 ms</p>                                                                                                                                                                                                                                                                                                                                                                                                                                               |
| *30 | Motor[1].PowerOn-Mode      | 0                                                                     | <p>1: Enables the motor after phase search.<br/>0: Kills the motor after phase search.</p>                                                                                                                                                                                                                                                                                                                                                                                                                                                                                                                                                                                           |

## 3-5 Confirmation of Settings

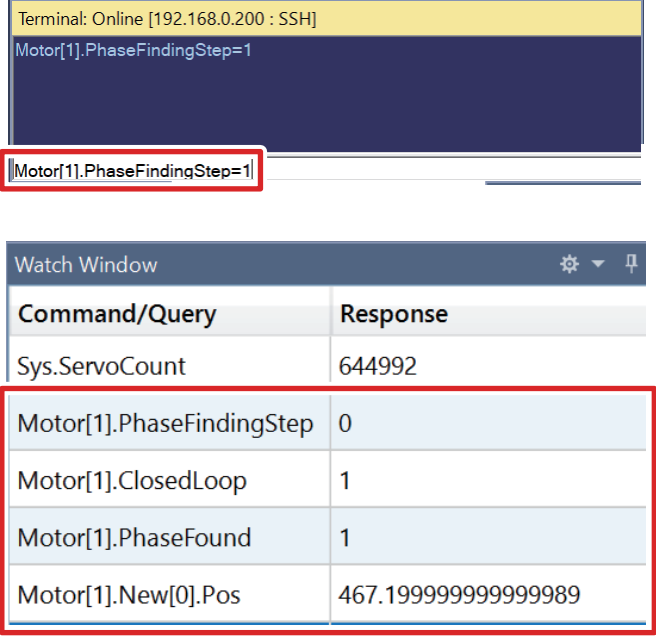
Follow the procedure below to check that the settings up to here are correct.

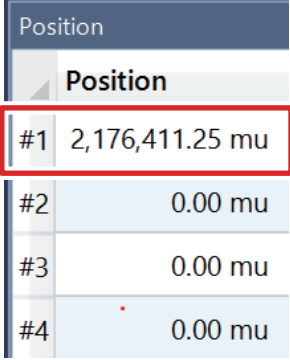
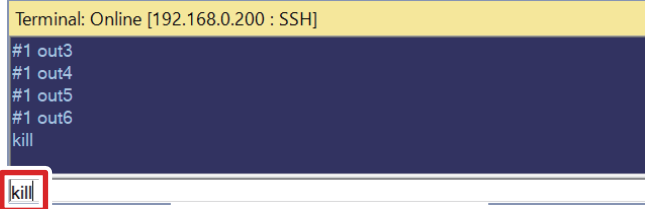
| <p><b>1</b> Type the <b>Motor[1].PhaseFindingStep=1</b> command from the Terminal to perform a phase search.</p> <ul style="list-style-type: none"> <li>The <b>Motor[1].PhaseFindingStep</b> value changes to 1, 6, 7, and 0. When the phase search succeeds, the <b>Motor[1].ClosedLoop</b> and <b>Motor[1].PhaseFound</b> values change from 0 to 1. In addition, the <b>Motor[1].New[0].Pos</b> value becomes larger than the <b>Motor[1].AbsPhasePosOffset</b> set value. The AMP ENAB 0 LED is turned on at that time. *1</li> </ul> |  <p>Terminal: Online [192.168.0.200 : SSH]<br/>Motor[1].PhaseFindingStep=1</p> <p>Motor[1].PhaseFindingStep=1</p> <table border="1"> <thead> <tr> <th>Command/Query</th> <th>Response</th> </tr> </thead> <tbody> <tr> <td>Sys.ServoCount</td> <td>644992</td> </tr> <tr> <td>Motor[1].PhaseFindingStep</td> <td>0</td> </tr> <tr> <td>Motor[1].ClosedLoop</td> <td>1</td> </tr> <tr> <td>Motor[1].PhaseFound</td> <td>1</td> </tr> <tr> <td>Motor[1].New[0].Pos</td> <td>467.199999999999989</td> </tr> </tbody> </table> | Command/Query | Response           | Sys.ServoCount | 644992     | Motor[1].PhaseFindingStep | 0 | Motor[1].ClosedLoop | 1 | Motor[1].PhaseFound | 1 | Motor[1].New[0].Pos | 467.199999999999989 |
|-------------------------------------------------------------------------------------------------------------------------------------------------------------------------------------------------------------------------------------------------------------------------------------------------------------------------------------------------------------------------------------------------------------------------------------------------------------------------------------------------------------------------------------------|---------------------------------------------------------------------------------------------------------------------------------------------------------------------------------------------------------------------------------------------------------------------------------------------------------------------------------------------------------------------------------------------------------------------------------------------------------------------------------------------------------------------------------------------------------------------------------------------------------------|---------------|--------------------|----------------|------------|---------------------------|---|---------------------|---|---------------------|---|---------------------|---------------------|
| Command/Query                                                                                                                                                                                                                                                                                                                                                                                                                                                                                                                             | Response                                                                                                                                                                                                                                                                                                                                                                                                                                                                                                                                                                                                      |               |                    |                |            |                           |   |                     |   |                     |   |                     |                     |
| Sys.ServoCount                                                                                                                                                                                                                                                                                                                                                                                                                                                                                                                            | 644992                                                                                                                                                                                                                                                                                                                                                                                                                                                                                                                                                                                                        |               |                    |                |            |                           |   |                     |   |                     |   |                     |                     |
| Motor[1].PhaseFindingStep                                                                                                                                                                                                                                                                                                                                                                                                                                                                                                                 | 0                                                                                                                                                                                                                                                                                                                                                                                                                                                                                                                                                                                                             |               |                    |                |            |                           |   |                     |   |                     |   |                     |                     |
| Motor[1].ClosedLoop                                                                                                                                                                                                                                                                                                                                                                                                                                                                                                                       | 1                                                                                                                                                                                                                                                                                                                                                                                                                                                                                                                                                                                                             |               |                    |                |            |                           |   |                     |   |                     |   |                     |                     |
| Motor[1].PhaseFound                                                                                                                                                                                                                                                                                                                                                                                                                                                                                                                       | 1                                                                                                                                                                                                                                                                                                                                                                                                                                                                                                                                                                                                             |               |                    |                |            |                           |   |                     |   |                     |   |                     |                     |
| Motor[1].New[0].Pos                                                                                                                                                                                                                                                                                                                                                                                                                                                                                                                       | 467.199999999999989                                                                                                                                                                                                                                                                                                                                                                                                                                                                                                                                                                                           |               |                    |                |            |                           |   |                     |   |                     |   |                     |                     |
| <p><b>2</b> Type the <b>#1 out1</b> command from the Terminal.</p>                                                                                                                                                                                                                                                                                                                                                                                                                                                                        |  <p>Terminal: Online [192.168.0.200 : SSH]<br/>\$\$\$<br/>Resetting PowerPMAC<br/>PowerPMAC Reset complete<br/>#1 out1</p> <p>#1 out1</p>                                                                                                                                                                                                                                                                                                                                                                                 |               |                    |                |            |                           |   |                     |   |                     |   |                     |                     |
| <p><b>3</b> Make sure that the motor is rotating. In addition, check that the Position window <b>Position</b> value is increasing in the positive direction.</p> <ul style="list-style-type: none"> <li>If the motor does not rotate even after typing the <b>#1 out1</b> command, increase the value gradually as <b>#1 out2, #1 out3</b>.</li> </ul>                                                                                                                                                                                    |  <p>Position</p> <table border="1"> <thead> <tr> <th>Position</th> </tr> </thead> <tbody> <tr> <td>#1 2,176,411.25 mu</td> </tr> <tr> <td>#2 0.00 mu</td> </tr> <tr> <td>#3 0.00 mu</td> </tr> <tr> <td>#4 0.00 mu</td> </tr> </tbody> </table>                                                                                                                                                                                                                                                                           | Position      | #1 2,176,411.25 mu | #2 0.00 mu     | #3 0.00 mu | #4 0.00 mu                |   |                     |   |                     |   |                     |                     |
| Position                                                                                                                                                                                                                                                                                                                                                                                                                                                                                                                                  |                                                                                                                                                                                                                                                                                                                                                                                                                                                                                                                                                                                                               |               |                    |                |            |                           |   |                     |   |                     |   |                     |                     |
| #1 2,176,411.25 mu                                                                                                                                                                                                                                                                                                                                                                                                                                                                                                                        |                                                                                                                                                                                                                                                                                                                                                                                                                                                                                                                                                                                                               |               |                    |                |            |                           |   |                     |   |                     |   |                     |                     |
| #2 0.00 mu                                                                                                                                                                                                                                                                                                                                                                                                                                                                                                                                |                                                                                                                                                                                                                                                                                                                                                                                                                                                                                                                                                                                                               |               |                    |                |            |                           |   |                     |   |                     |   |                     |                     |
| #3 0.00 mu                                                                                                                                                                                                                                                                                                                                                                                                                                                                                                                                |                                                                                                                                                                                                                                                                                                                                                                                                                                                                                                                                                                                                               |               |                    |                |            |                           |   |                     |   |                     |   |                     |                     |
| #4 0.00 mu                                                                                                                                                                                                                                                                                                                                                                                                                                                                                                                                |                                                                                                                                                                                                                                                                                                                                                                                                                                                                                                                                                                                                               |               |                    |                |            |                           |   |                     |   |                     |   |                     |                     |
| <p><b>4</b> Type the <b>kill</b> command from the Terminal to stop the motor.</p>                                                                                                                                                                                                                                                                                                                                                                                                                                                         |  <p>Terminal: Online [192.168.0.200 : SSH]<br/>#1 out3<br/>#1 out4<br/>#1 out5<br/>#1 out6<br/>kill</p> <p>kill</p>                                                                                                                                                                                                                                                                                                                                                                                                       |               |                    |                |            |                           |   |                     |   |                     |   |                     |                     |

\*1. If **Motor[1].PhaseFound** does not indicate 1, the phase search has failed. Check if the set value is appropriate.

The following shows some examples of set value adjustment when a phase search fails.

- If the **Motor[1].New[0].Pos** value is smaller than the **Motor[1].AbsPhasePosOffset** set value after phase search, increase the **Motor[1].PhaseFindingDac** value. In addition, check that the **Motor[1].PhasePosSf** set value is appropriate.
- If an error occurs in I2tFault status during phase search, decrease the value of **Motor[1].PhaseFindingDac** or **Motor[1].PhaseFindingTime**.
- If the **Motor[1].New[0].Pos** value indicates – (subtraction) after phase search, change signs of **Motor[1].PhasePosSf** and **EncTable[1].ScaleFactor**.



## 3-6 Motor Tuning

Follow the procedure below to use Power PMAC IDE tuning tools for tuning the motor.

### 3-6-1 Open Loop Test

Follow the procedure below to operate the motor in an open loop, and check that each setting is correct.

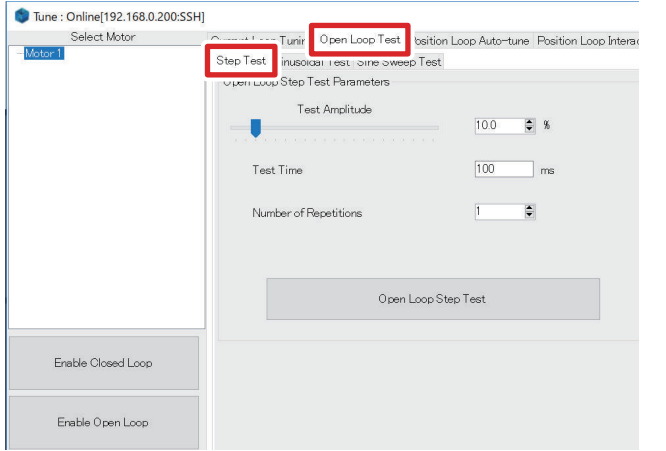
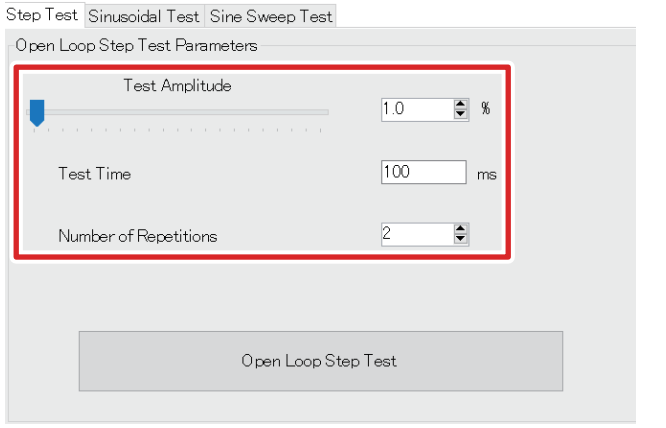
|                 |                                                                                                                                                                                                                     |                                                                                      |
|-----------------|---------------------------------------------------------------------------------------------------------------------------------------------------------------------------------------------------------------------|--------------------------------------------------------------------------------------|
| <p><b>1</b></p> | <p>From the <b>Tools</b> menu in <b>Delta Tau</b>, select <b>Advanced Tuning</b> to open the Tune screen, and then select <b>Open LoopTest – Step Test</b>.</p>                                                     |   |
| <p><b>2</b></p> | <p>Set the following tuning parameters.</p> <p><b>Test Amplitude:</b> 1.0%*1</p> <p><b>Test Time:</b> 100 ms</p> <p><b>Number of Repetitions:</b> 2</p> <p>*1. If the motor does not rotate, set a large value.</p> |  |

#### 3 Click the **Open Loop Step Test** button.

Step Test | Sinusoidal Test | Sine Sweep Test

Open Loop Step Test Parameters

Test Amplitude: 1.0 %

Test Time: 100 ms

Number of Repetitions: 2

**Open Loop Step Test**

- The motor is performing reciprocating operation and the test result on the right is displayed.
- If the motor does not rotate, change the **Test Amplitude** parameter to a large value.
- The test result is when the **Test Amplitude** parameter is set to 8.0%.

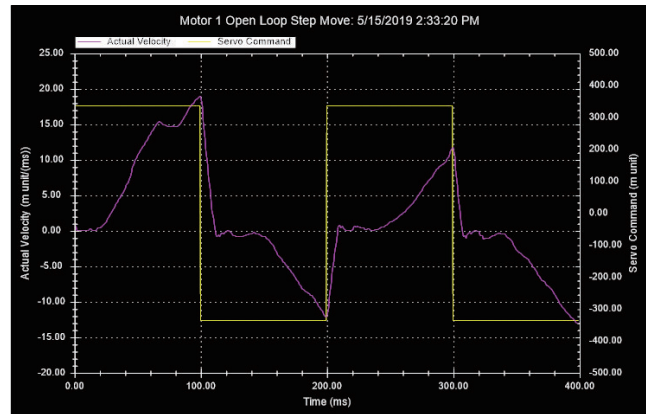

### 3-6-2 Current Loop Gain Setting

Follow the procedure below to perform current loop gain settings and adjust them to achieve desired response characteristics.

#### 1 In the Tune screen, select **Current Loop Tuning – Interactive Tune**.

Tune - Online[192.168.0.200]

Select Motor: **Current Loop Tuning** | **Interactive Tune**

Auto-tune Parameters

Integral Gain (IiGain): 0.009999998

Forward Path Proportional Gain (IpfGain): 1

Back Path Proportional Gain (IpbGain): 0

Phase Current Bias Offsets

Phase A (IaBias): 0.44

Phase B (IbBias): -0.38

Current Loop Step Parameter Setup

Magnitude: 3000 bits

Rough Phasing Magnitude: 1000 bits

Dwell Time: 50 ms

Do A Current Loop Step

Kill Motor

- #### 2 Set the following parameters.
- IiGain:** 0.009999998 (Default)
  - IpfGain:** 0
  - IpbGain:** 0
  - Magnitude:** 3000 bits
  - Dwell Time:** 50 ms

Simple Auto-tune | Auto-tune | Interactive Tune

Auto-tune Parameters

Integral Gain (IiGain): 0.009999998

Forward Path Proportional Gain (IpfGain): 0

Back Path Proportional Gain (IpbGain): 0

Phase Current Bias Offsets

Phase A (IaBias): 0

Phase B (IbBias): 0

Current Loop Step Parameter Setup

Magnitude: 3000 bits

Rough Phasing Magnitude: 1000 bits

Dwell Time: 50 ms

Do A Current Loop Step

Kill Motor

**3** Click the **Do A Current Loop Step** button.

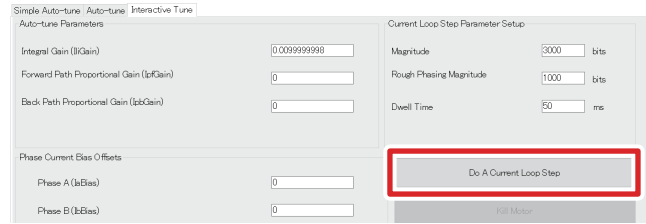

- The current step response is displayed.

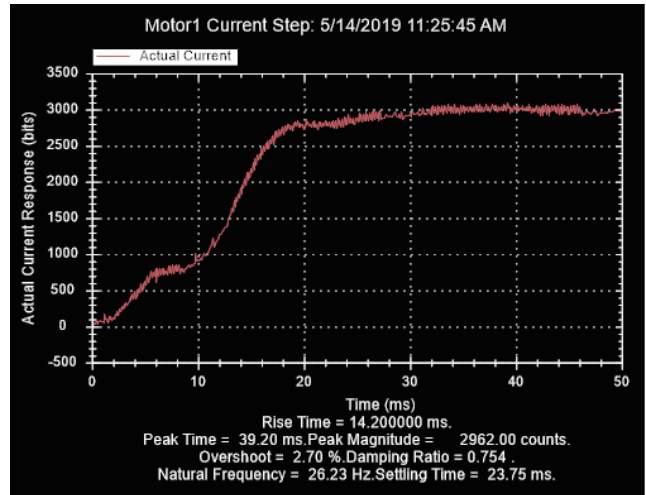

**4** Adjust the **IliGain**, **IpfGain**, and **IpbGain** parameters to achieve the desired response characteristics.

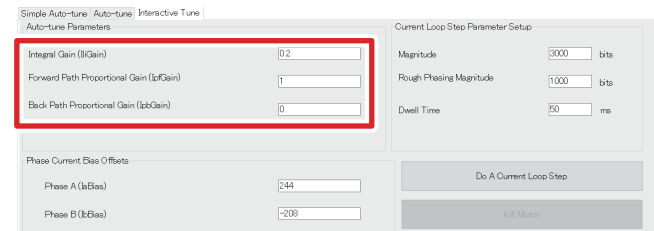

- If the startup response is slow, increase the **IliGain** parameter.
- If the overshooting or vibration is large, increase the **IpfGain** or **IpbGain** parameter.
- Increase each gain parameter gradually starting from a small value.

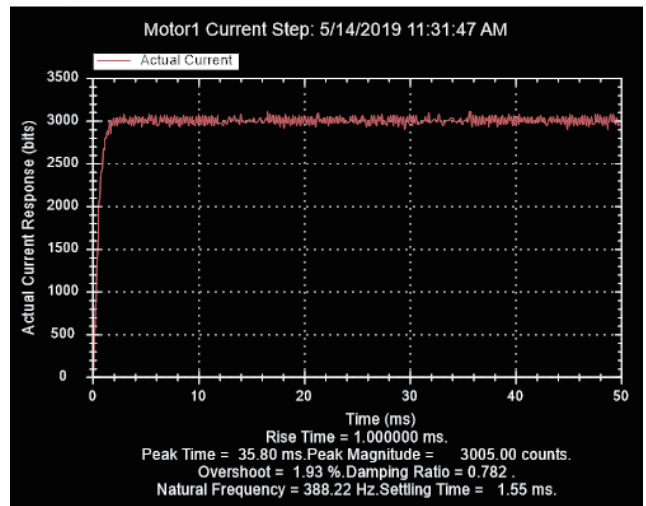

3-6 Motor Tuning

3

3-6-3 Bandwidth Automatic Setting

### 3-6-3 Bandwidth Automatic Setting

Follow the procedure below to use the auto-tuning function for setting the servo loop bandwidth automatically.

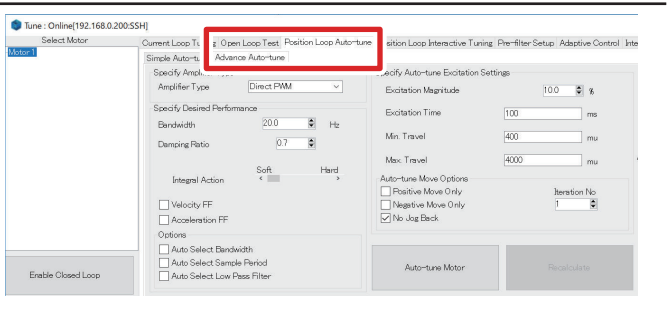
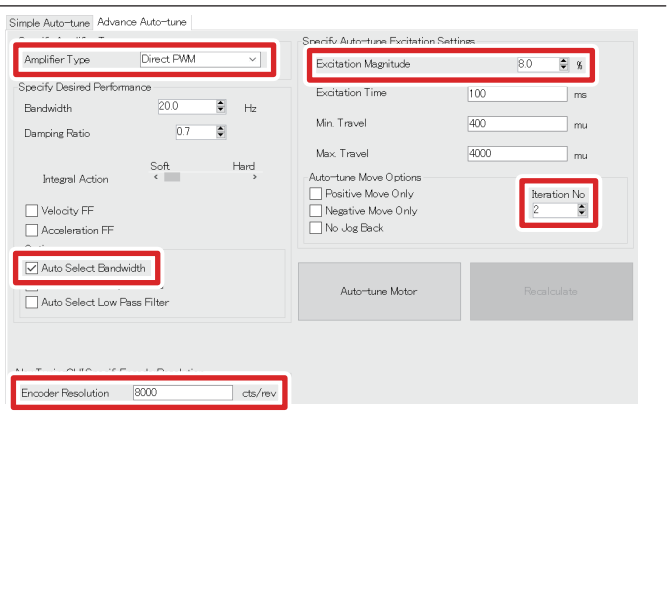
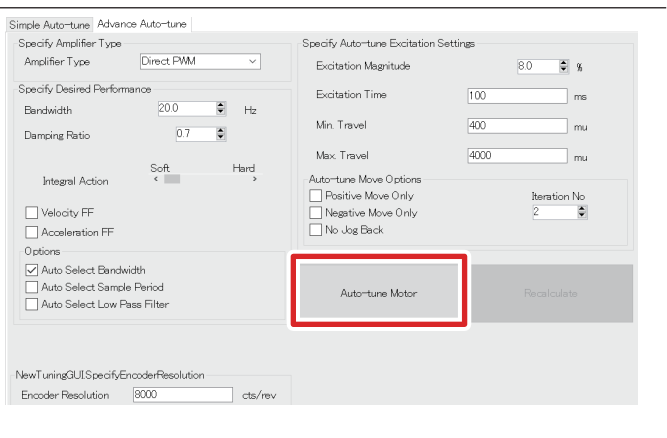
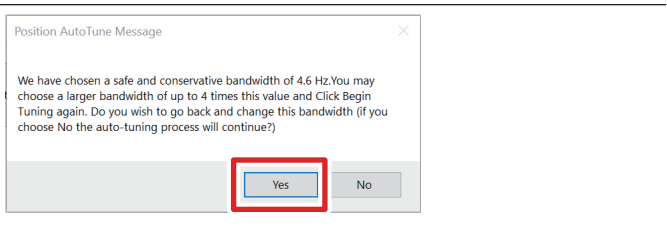
|                 |                                                                                                                                                                                                                                                                                                                                                                                                                                                                                                                                                                                                                                                           |                                                                                      |
|-----------------|-----------------------------------------------------------------------------------------------------------------------------------------------------------------------------------------------------------------------------------------------------------------------------------------------------------------------------------------------------------------------------------------------------------------------------------------------------------------------------------------------------------------------------------------------------------------------------------------------------------------------------------------------------------|--------------------------------------------------------------------------------------|
| <p><b>1</b></p> | <p>In the Tune screen, select <b>Position Loop Auto-tune – Advance Auto-tune</b>.</p>                                                                                                                                                                                                                                                                                                                                                                                                                                                                                                                                                                     |    |
| <p><b>2</b></p> | <p>Set the following parameters.<br/> <b>Amplifier Type:</b> Direct PWM<br/> <b>Auto Select Bandwidth:</b> Select the check box.<br/> <b>Encoder Resolution:</b> 8000 cts/rev<br/> <b>Excitation Magnitude:</b> 8.0%*1<br/> <b>Iteration No.:</b> 2<br/> *1. Select the value rotated in the open loop in step 3 in 3-6-1 <i>Open Loop Test</i> on page 3-19.</p> <ul style="list-style-type: none"> <li>For <b>Encoder Resolution</b>, set the pulse counts per one motor rotation. In this example, 2000 pulses per rotation of the digital quadrature encoder is set to be multiplied by four, so <b>Encoder Resolution</b> indicates 8000.</li> </ul> |   |
| <p><b>3</b></p> | <p>Click the <b>Auto-tune Motor</b> button.</p>                                                                                                                                                                                                                                                                                                                                                                                                                                                                                                                                                                                                           |  |
| <p><b>4</b></p> | <p>If the message on the right appears, click the <b>Yes</b> button.</p>                                                                                                                                                                                                                                                                                                                                                                                                                                                                                                                                                                                  |  |

**5** If the screen on the right appears, click the **Implement** button.

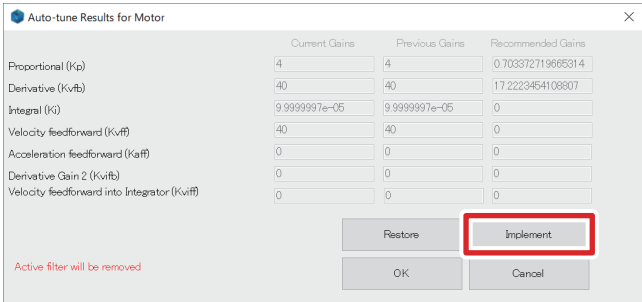

|                                              | Current Gains | Previous Gains | Recommended Gains |
|----------------------------------------------|---------------|----------------|-------------------|
| Proportional (Kp)                            | 4             | 4              | 0.70337219665314  |
| Derivative (Kvfb)                            | 40            | 40             | 17.2223454106807  |
| Integral (Ki)                                | 9.9999997e-05 | 9.9999997e-05  | 0                 |
| Velocity feedforward (Kvff)                  | 40            | 40             | 0                 |
| Acceleration feedforward (Kaff)              | 0             | 0              | 0                 |
| Derivative Gain 2 (Kvfb2)                    | 0             | 0              | 0                 |
| Velocity feedforward into Integrator (Kvff2) | 0             | 0              | 0                 |

**6** Check that the **Recommended Gains** values are applied to **Current Gains**, and then click the **OK** button.

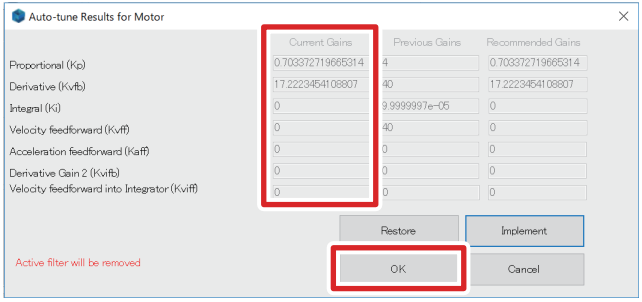

|                                              | Current Gains    | Previous Gains | Recommended Gains |
|----------------------------------------------|------------------|----------------|-------------------|
| Proportional (Kp)                            | 0.70337219665314 | 4              | 0.70337219665314  |
| Derivative (Kvfb)                            | 17.2223454106807 | 40             | 17.2223454106807  |
| Integral (Ki)                                | 0                | 9.9999997e-05  | 0                 |
| Velocity feedforward (Kvff)                  | 0                | 40             | 0                 |
| Acceleration feedforward (Kaff)              | 0                | 0              | 0                 |
| Derivative Gain 2 (Kvfb2)                    | 0                | 0              | 0                 |
| Velocity feedforward into Integrator (Kvff2) | 0                | 0              | 0                 |

### 3-6-4 Manual Setting of Bandwidth

Follow the procedure below to set a more appropriate bandwidth, while monitoring the step response characteristic.

**1** Select **Position Loop Interactive Tuning – Step** in the Tune screen.

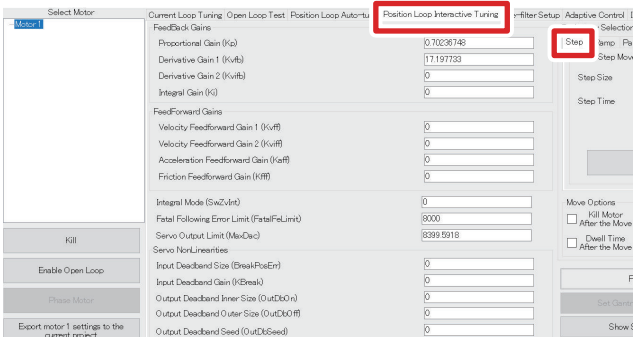

**2** Set the following parameters.  
**Step Size: 2500 mu**

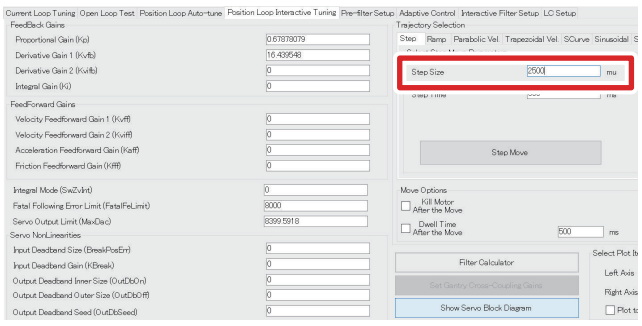

| Parameter                            | Value     |
|--------------------------------------|-----------|
| Proportional Gain (Kp)               | 0.6707079 |
| Derivative Gain 1 (Kvfb)             | 16.439548 |
| Derivative Gain 2 (Kvfb2)            | 0         |
| Integral Gain (Ki)                   | 0         |
| Velocity Feedforward Gain 1 (Kvff)   | 0         |
| Velocity Feedforward Gain 2 (Kvff2)  | 0         |
| Acceleration Feedforward Gain (Kaff) | 0         |
| Friction Feedforward Gain (Kff)      | 0         |
| Step Size                            | 2500 mu   |

**3** Click the **Step Move** button.

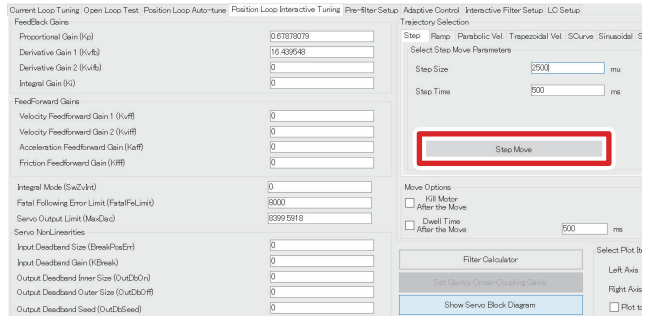

**4** Check the step response characteristic.

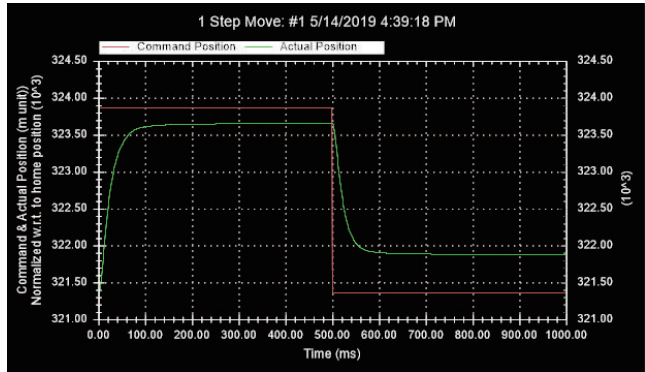

**5** If the target position has not been reached, return to the **Advance Auto-tune** screen, and set an even larger value for **Bandwidth**.

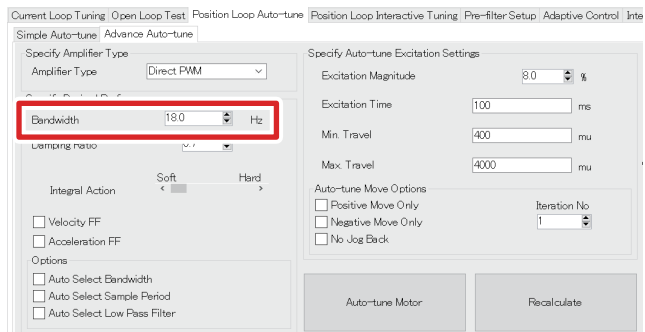

**6** Click the **Recalculate** button.

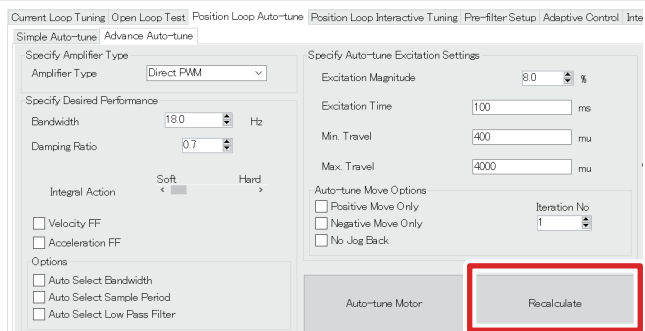

**7** If the screen on the right appears, click the **Implement** button.

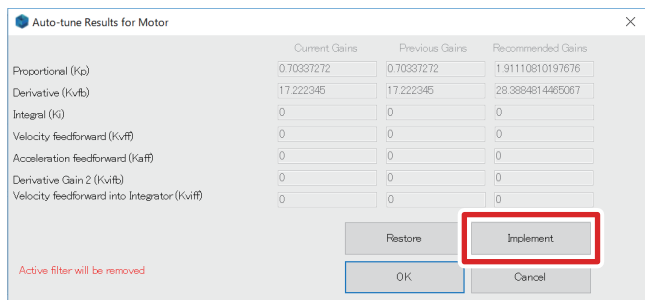

**8** Check that the **Recommended Gains** values are applied to **Current Gains**, and then click the **OK** button.

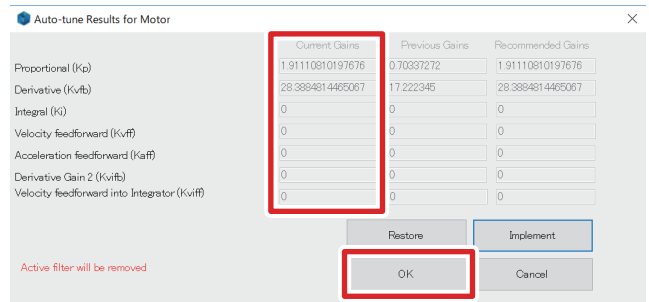

**9** Return to step 1 and repeat the procedure until the desired responsiveness is obtained.

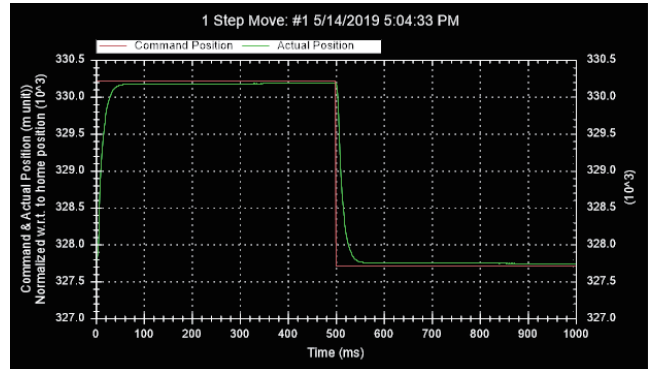

### 3-6-5 Feed-Forward Value Setting

Follow the procedure below to set a more appropriate bandwidth, while monitoring the step response characteristic.

**1** In the Tune screen, select **Position Loop Auto-tune – Advance Auto-tune**, and insert checks into **Velocity FF** and **Acceleration FF**.

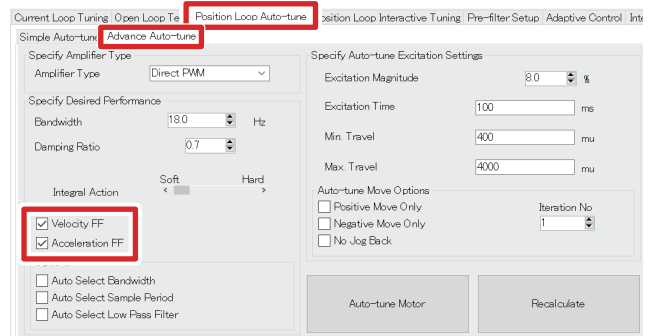

**2** Click the **Recalculate** button.

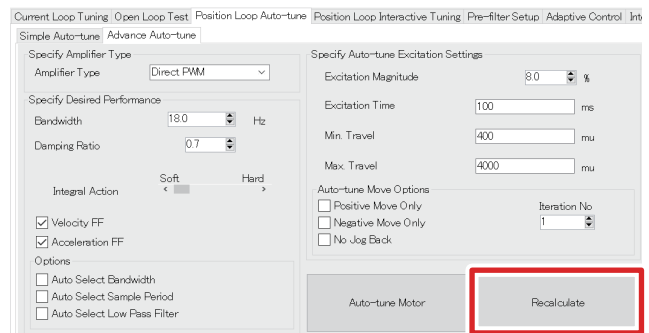

**3**

If the screen on the right appears, click the **Implement** button.

**4**

Check that the **Recommended Gains** values are applied to **Current Gains**, and then click the **OK** button.

**5**

Select **Position Loop Interactive Tuning – Parabolic Vel.** and set the following parameters.

**Move Size: 2500 mu**  
**Move Time: 500 ms**  
**Left Axis: Velocity**  
**Right Axis: Following Error**

**6**

Click the **Parabolic Velocity Move** button.

**7**

Check the parabolic response characteristic of velocity.

|                                              | Current Gains | Previous Gains | Recommended Gains |
|----------------------------------------------|---------------|----------------|-------------------|
| Proportional (Kp)                            | 1.9111081     | 1.9111081      | 1.91110810197676  |
| Derivative (Kvfb)                            | 28.388481     | 28.388481      | 28.3884814465067  |
| Integral (Ki)                                | 0             | 0              | 0                 |
| Velocity feedforward (Kvff)                  | 0             | 0              | 28.3884814465067  |
| Acceleration feedforward (Kaff)              | 0             | 0              | 215.150816623052  |
| Derivative Gain 2 (Kvfb2)                    | 0             | 0              | 0                 |
| Velocity feedforward into Integrator (Kviff) | 0             | 0              | 0                 |

|                                              | Current Gains    | Previous Gains | Recommended Gains |
|----------------------------------------------|------------------|----------------|-------------------|
| Proportional (Kp)                            | 1.91110810197676 | 1.9111081      | 1.91110810197676  |
| Derivative (Kvfb)                            | 28.3884814465067 | 28.388481      | 28.3884814465067  |
| Integral (Ki)                                | 0                | 0              | 0                 |
| Velocity feedforward (Kvff)                  | 28.3884814465067 |                | 28.3884814465067  |
| Acceleration feedforward (Kaff)              | 215.150816623052 |                | 215.150816623052  |
| Derivative Gain 2 (Kvfb2)                    | 0                | 0              | 0                 |
| Velocity feedforward into Integrator (Kviff) | 0                | 0              | 0                 |

3-26

CK3M/CK5M Series Startup Guide DirectPWM Interface (O047)



**8** If **Following Error** has a positive correlation to the velocity, make **Kvff** larger. If it has a reverse correlation, make **Kvff** smaller.

| Current Loop Tuning                  |           |
|--------------------------------------|-----------|
| Feedback Gains                       |           |
| Proportional Gain (Kp)               | 1.9111081 |
| Derivative Gain 1 (Kvfb)             | 28.388461 |
| Derivative Gain 2 (Kvifb)            | 0         |
| Integral Gain (Ki)                   | 0         |
| FeedForward Gains                    |           |
| Velocity Feedforward Gain 1 (Kvff)   | 60        |
| Velocity Feedforward Gain 2 (Kviff)  | 0         |
| Acceleration Feedforward Gain (Kaff) | 215.15082 |
| Friction Feedforward Gain (Kff)      | 0         |

**9** Click the **Parabolic Velocity Move** button again.  
 • Repeat this until the correlation of **Following Error** to the velocity disappears.

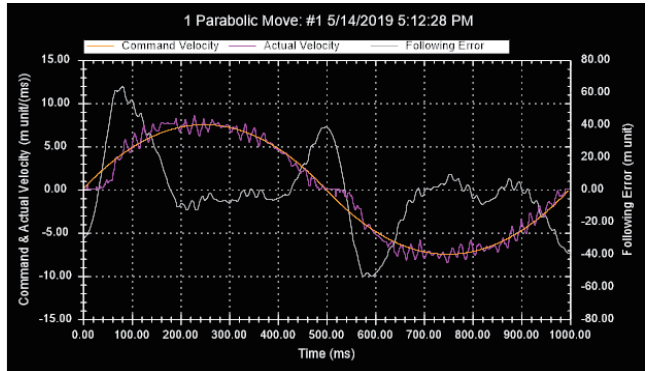

**10** In the same way, if **Following Error** has a correlation to **Acceleration**, **Position**, etc., increase or decrease the **Kaff** and **Kff** values.

### 3-6-6 Checking of Operation and Creation of Tuning Parameter Project

Follow the procedure below to check operations and create a tuned parameter project.

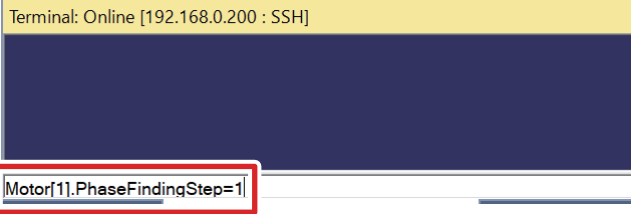
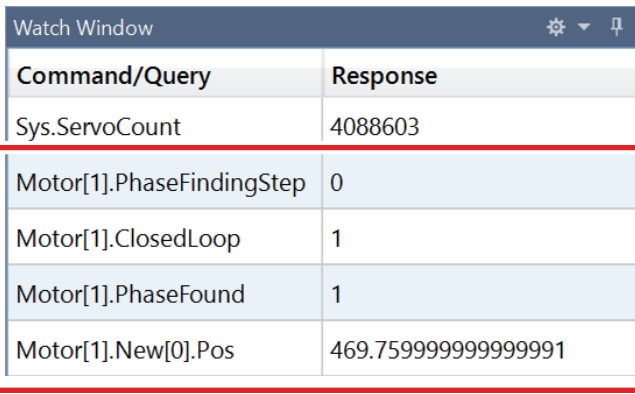
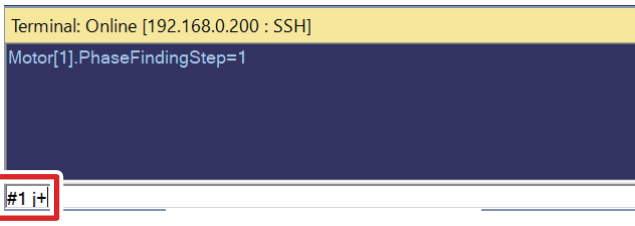
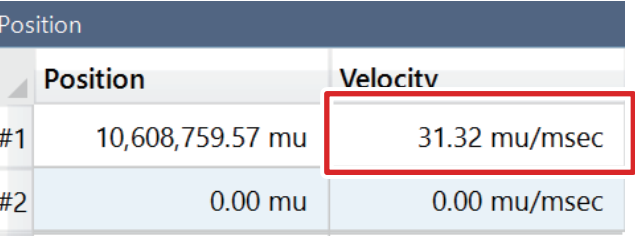
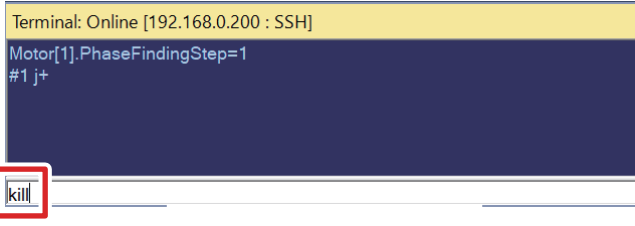
| <p><b>1</b></p> <p>Type the <b>Motor[1].PhaseFindingStep=1</b> command from the Terminal to perform a phase search.</p> <ul style="list-style-type: none"> <li>• The <b>Motor[1].PhaseFindingStep</b> value changes to 1, 6, 7, and 0.</li> <li>• When the phase search succeeds, the <b>Motor[1].ClosedLoop</b> and <b>Motor[1].PhaseFound</b> values change from 0 to 1. In addition, the <b>Motor[1].New[0].Pos</b> value becomes larger than the <b>Motor[1].AbsPhasePosOffset</b> set value. The AMP ENAB 0 LED is turned on at that time.</li> </ul> |  <p>Terminal: Online [192.168.0.200 : SSH]</p> <pre>Motor[1].PhaseFindingStep=1</pre><br> <table border="1"> <thead> <tr> <th>Command/Query</th> <th>Response</th> </tr> </thead> <tbody> <tr> <td>Sys.ServoCount</td> <td>4088603</td> </tr> <tr> <td>Motor[1].PhaseFindingStep</td> <td>0</td> </tr> <tr> <td>Motor[1].ClosedLoop</td> <td>1</td> </tr> <tr> <td>Motor[1].PhaseFound</td> <td>1</td> </tr> <tr> <td>Motor[1].New[0].Pos</td> <td>469.75999999999991</td> </tr> </tbody> </table> | Command/Query | Response | Sys.ServoCount | 4088603 | Motor[1].PhaseFindingStep | 0        | Motor[1].ClosedLoop | 1                | Motor[1].PhaseFound | 1  | Motor[1].New[0].Pos | 469.75999999999991 |
|------------------------------------------------------------------------------------------------------------------------------------------------------------------------------------------------------------------------------------------------------------------------------------------------------------------------------------------------------------------------------------------------------------------------------------------------------------------------------------------------------------------------------------------------------------|------------------------------------------------------------------------------------------------------------------------------------------------------------------------------------------------------------------------------------------------------------------------------------------------------------------------------------------------------------------------------------------------------------------------------------------------------------------------------------------------------------------------------------------------------------------------------------------------------------------------------------------------------------------------|---------------|----------|----------------|---------|---------------------------|----------|---------------------|------------------|---------------------|----|---------------------|--------------------|
| Command/Query                                                                                                                                                                                                                                                                                                                                                                                                                                                                                                                                              | Response                                                                                                                                                                                                                                                                                                                                                                                                                                                                                                                                                                                                                                                               |               |          |                |         |                           |          |                     |                  |                     |    |                     |                    |
| Sys.ServoCount                                                                                                                                                                                                                                                                                                                                                                                                                                                                                                                                             | 4088603                                                                                                                                                                                                                                                                                                                                                                                                                                                                                                                                                                                                                                                                |               |          |                |         |                           |          |                     |                  |                     |    |                     |                    |
| Motor[1].PhaseFindingStep                                                                                                                                                                                                                                                                                                                                                                                                                                                                                                                                  | 0                                                                                                                                                                                                                                                                                                                                                                                                                                                                                                                                                                                                                                                                      |               |          |                |         |                           |          |                     |                  |                     |    |                     |                    |
| Motor[1].ClosedLoop                                                                                                                                                                                                                                                                                                                                                                                                                                                                                                                                        | 1                                                                                                                                                                                                                                                                                                                                                                                                                                                                                                                                                                                                                                                                      |               |          |                |         |                           |          |                     |                  |                     |    |                     |                    |
| Motor[1].PhaseFound                                                                                                                                                                                                                                                                                                                                                                                                                                                                                                                                        | 1                                                                                                                                                                                                                                                                                                                                                                                                                                                                                                                                                                                                                                                                      |               |          |                |         |                           |          |                     |                  |                     |    |                     |                    |
| Motor[1].New[0].Pos                                                                                                                                                                                                                                                                                                                                                                                                                                                                                                                                        | 469.75999999999991                                                                                                                                                                                                                                                                                                                                                                                                                                                                                                                                                                                                                                                     |               |          |                |         |                           |          |                     |                  |                     |    |                     |                    |
| <p><b>2</b></p> <p>Type the <b>#1 j+</b> command from the Terminal.</p>                                                                                                                                                                                                                                                                                                                                                                                                                                                                                    |  <p>Terminal: Online [192.168.0.200 : SSH]</p> <pre>Motor[1].PhaseFindingStep=1</pre> <pre>#1 j+</pre>                                                                                                                                                                                                                                                                                                                                                                                                                                                                              |               |          |                |         |                           |          |                     |                  |                     |    |                     |                    |
| <p><b>3</b></p> <p>Make sure that the motor is rotating. In addition, confirm that the #1 <b>Velocity</b> value is around 32 in the Position window.</p> <ul style="list-style-type: none"> <li>• <b>Velocity</b> depends on <b>Motor[1].JogSpeed</b> (32 by default).</li> </ul>                                                                                                                                                                                                                                                                          |  <table border="1"> <thead> <tr> <th colspan="3">Position</th> </tr> <tr> <th></th> <th>Position</th> <th>Velocity</th> </tr> </thead> <tbody> <tr> <td>#1</td> <td>10,608,759.57 mu</td> <td>31.32 mu/msec</td> </tr> <tr> <td>#2</td> <td>0.00 mu</td> <td>0.00 mu/msec</td> </tr> </tbody> </table>                                                                                                                                                                                                                                                                             | Position      |          |                |         | Position                  | Velocity | #1                  | 10,608,759.57 mu | 31.32 mu/msec       | #2 | 0.00 mu             | 0.00 mu/msec       |
| Position                                                                                                                                                                                                                                                                                                                                                                                                                                                                                                                                                   |                                                                                                                                                                                                                                                                                                                                                                                                                                                                                                                                                                                                                                                                        |               |          |                |         |                           |          |                     |                  |                     |    |                     |                    |
|                                                                                                                                                                                                                                                                                                                                                                                                                                                                                                                                                            | Position                                                                                                                                                                                                                                                                                                                                                                                                                                                                                                                                                                                                                                                               | Velocity      |          |                |         |                           |          |                     |                  |                     |    |                     |                    |
| #1                                                                                                                                                                                                                                                                                                                                                                                                                                                                                                                                                         | 10,608,759.57 mu                                                                                                                                                                                                                                                                                                                                                                                                                                                                                                                                                                                                                                                       | 31.32 mu/msec |          |                |         |                           |          |                     |                  |                     |    |                     |                    |
| #2                                                                                                                                                                                                                                                                                                                                                                                                                                                                                                                                                         | 0.00 mu                                                                                                                                                                                                                                                                                                                                                                                                                                                                                                                                                                                                                                                                | 0.00 mu/msec  |          |                |         |                           |          |                     |                  |                     |    |                     |                    |
| <p><b>4</b></p> <p>Type the <b>kill</b> command from the Terminal to stop the motor.</p>                                                                                                                                                                                                                                                                                                                                                                                                                                                                   |  <p>Terminal: Online [192.168.0.200 : SSH]</p> <pre>Motor[1].PhaseFindingStep=1</pre> <pre>#1 j+</pre> <pre>kill</pre>                                                                                                                                                                                                                                                                                                                                                                                                                                                             |               |          |                |         |                           |          |                     |                  |                     |    |                     |                    |

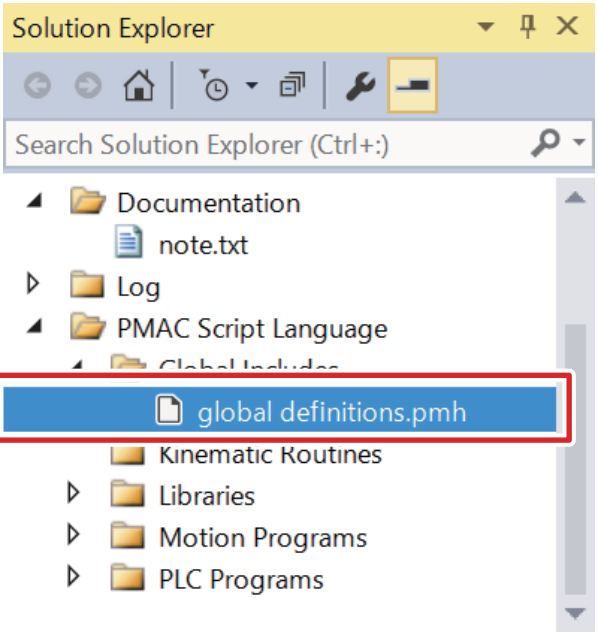
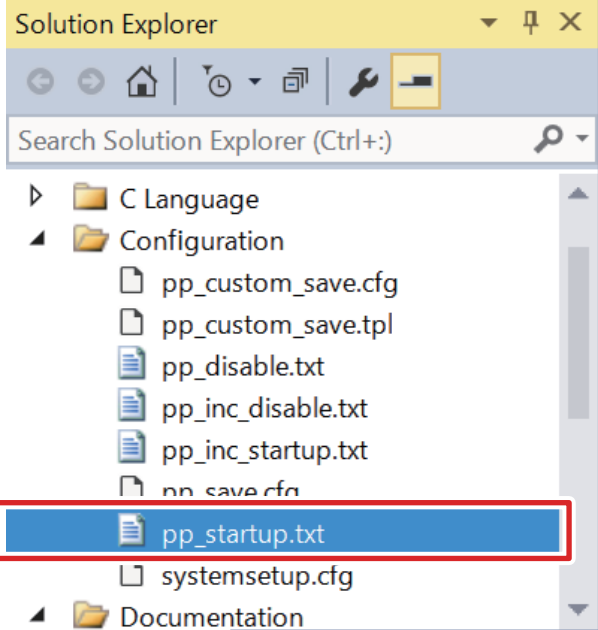
|                 |                                                                                                                      |                                                                                                                                                                                      |
|-----------------|----------------------------------------------------------------------------------------------------------------------|--------------------------------------------------------------------------------------------------------------------------------------------------------------------------------------|
| <p><b>5</b></p> | <p>Open the global definitions.pmh under <b>PMAC Script Language – Global Includes</b> in the Solution Explorer.</p> |                                                                                                    |
| <p><b>6</b></p> | <p>Add the gain values obtained from tuning to the global definitions.pmh.</p>                                       | <pre>Motor[1].IiGain = *** Motor[1].IpfGain = *** Motor[1].IpbGain = *** Motor[1].Servo.Kp = *** Motor[1].Servo.Kvfb = *** Motor[1].Servo.Kaff = *** Motor[1].Servo.Kvff = ***</pre> |
| <p><b>7</b></p> | <p>Open the pp_startup.txt under <b>Configuration</b> in the Solution Explorer.</p>                                  |                                                                                                  |
| <p><b>8</b></p> | <p>Write the phase search implementation command shown on the right.</p>                                             | <pre>Motor[1].PhaseFindingStep = 1</pre>                                                                                                                                             |

### 9

Select the project and execute Build and Download.

- Refer to step 3 through 6 in *3-4 Various Controller Settings* on page 3-8 for the Build and Download method.
- As shown in step 5 and 6, gains can be downloaded on PMAC as a program if you write gains in the global definitions.pmh.
- As shown in step 7 and 8, the phase search is automatically performed after the power is turned ON or reset to enable Motor[1] if you write the phase search implementation command in the pp\_startup.txt.



## **OMRON Corporation Industrial Automation Company**

**Kyoto, JAPAN**

**Contact : [www.ia.omron.com](http://www.ia.omron.com)**

### ***Regional Headquarters***

#### **OMRON EUROPE B.V.**

Wegalaan 67-69, 2132 JD Hoofddorp  
The Netherlands

Tel: (31) 2356-81-300 Fax: (31) 2356-81-388

#### **OMRON ASIA PACIFIC PTE. LTD.**

438B Alexandra Road, #08-01/02 Alexandra  
Technopark, Singapore 119968

Tel: (65) 6835-3011 Fax: (65) 6835-2711

#### **OMRON ELECTRONICS LLC**

2895 Greenspoint Parkway, Suite 200  
Hoffman Estates, IL 60169 U.S.A.

Tel: (1) 847-843-7900 Fax: (1) 847-843-7787

#### **OMRON (CHINA) CO., LTD.**

Room 2211, Bank of China Tower,  
200 Yin Cheng Zhong Road,  
PuDong New Area, Shanghai, 200120, China

Tel: (86) 21-5037-2222 Fax: (86) 21-5037-2200

**Authorized Distributor:**

©OMRON Corporation 2019 - 2023 All Rights Reserved.  
In the interest of product improvement,  
specifications are subject to change without notice.

**Cat. No. 0047-E1-02** 0123