

USER'S MANUAL

DeviceNet Communications Unit

MODEL 3G3MV-PDRT2

(For SYSDRIVE 3G3MV Multi-function Compact Inverters)

DeviceNet Communications Card

MODEL 3G3RV-PDRT2

(For SYSDRIVE 3G3RV and 3G3FV High-function General-purpose Inverters)

Thank you for choosing a 3G3MV/3G3RV Series Inverter and DeviceNet Communications Unit. This manual describes the specifications and operating methods of the DeviceNet Communications Unit used for exchanging data between an Inverter and a Programmable Controller. Specifically, it describes the operation methods, communications methods, and data setting methods of the 3G3MV-PDRT2 DeviceNet Communications Unit and 3G3RV-PDRT2 DeviceNet Communications Card. Proper use and handling of the product will help ensure proper product performance, will lengthen product life, and may prevent possible accidents. Please read this manual thoroughly and handle and operate the product with care. For details about the 3G3MV Inverter and DeviceNet communications system, refer to the following reference manuals.

Inverter Manuals
DeviceNet Manuals

1. To ensure safe and proper use of the OMRON Inverters, please read this USER'S MANUAL (Cat. No. I539-E1) to gain sufficient knowledge of the devices, safety information, and precautions before actual use.
2. The products are illustrated without covers and shieldings for closer look in this USER'S MANUAL. For actual use of the products, make sure to use the covers and shieldings as specified.
3. This USER'S MANUAL and other related user's manuals are to be delivered to the actual end users of the products.
4. Please keep this manual close at hand for future reference.
5. If the product has been left unused for a long time, please inquire at our sales representative.

NOTICE

1. This manual describes the functions of the product and relations with other products. You should assume that anything not described in this manual is not possible.
2. "PLC" in this manual refers to the SYSMAC CS/CJ-series, C200HX/HG/HE, and CV-series Programmable Controllers that can be connected to a DeviceNet System. (C200HS Programmable Controllers support only the remote I/O function.)
3. Although care has been given in documenting the product, please contact your OMRON representative if you have any suggestions on improving this manual.
4. The product contains potentially dangerous parts under the cover. Do not attempt to open the cover under any circumstances. Doing so may result in injury or death and may damage the product. Never attempt to repair or disassemble the product.
5. We recommend that you add the following precautions to any instruction manuals you prepare for the system into which the product is being installed.
 - Precautions on the dangers of high-voltage equipment.
 - Precautions on touching the terminals of the product even after power has been turned off. (These terminals are live even with the power turned off.)
6. Inverter and Option Unit wiring and Digital Operator operations must be performed by somebody with a specialist knowledge of electrical systems.
7. The individual life expectancies of the Inverter's internal components must be considered. Perform maintenance, such as Unit replacement, appropriate for the operating conditions.
8. Specifications and functions may be changed without notice in order to improve product performance.

Items to Check Before Unpacking

Check the following items before removing the product from the package:

- Has the correct product been delivered (i.e., the correct model number and specifications)?
- Has the product been damaged in shipping?
- Are any screws or bolts loose?
- Have all accessories been delivered together with or attached to the product?

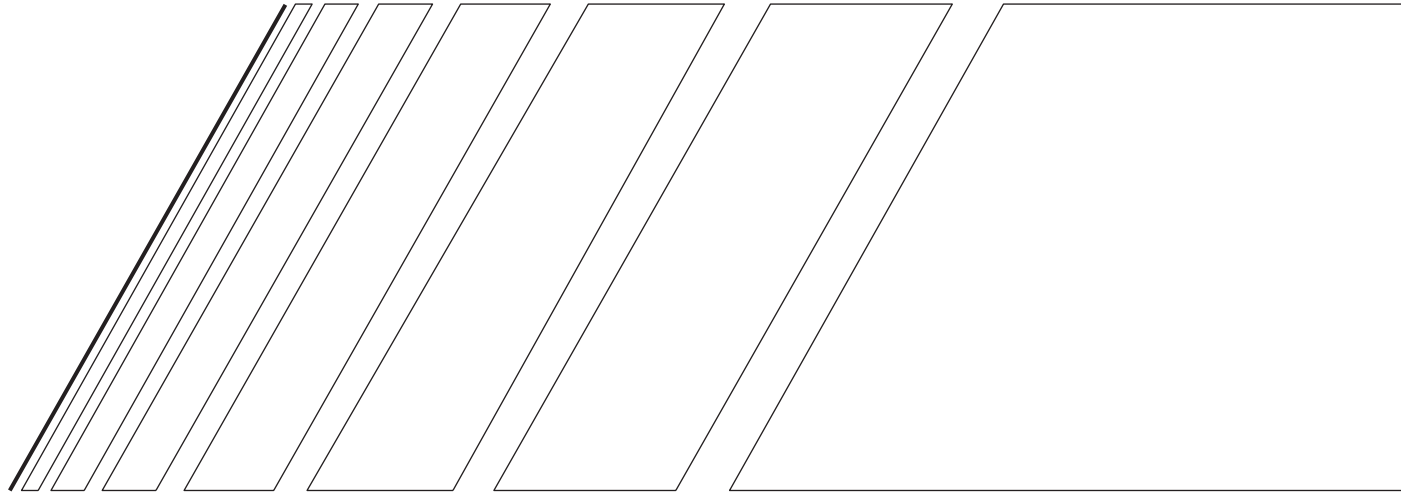

USER'S MANUAL

DeviceNet Communications Unit

MODEL 3G3MV-PDRT2

(For SYSDRIVE 3G3MV Multi-function Compact Inverters)

DeviceNet Communications Card

MODEL 3G3RV-PDRT2

(For SYSDRIVE 3G3RV and 3G3FV High-function General-purpose Inverters)

Notice:

OMRON products are manufactured for use according to proper procedures by a qualified operator and only for the purposes described in this manual.

The following conventions are used to indicate and classify precautions in this manual. Always heed the information provided with them. Failure to heed precautions can result in injury to people or damage to property.

 **DANGER** Indicates an imminently hazardous situation which, if not avoided, will result in death or serious injury. Additionally, there may be severe property damage.

 **WARNING** Indicates a potentially hazardous situation which, if not avoided, could result in death or serious injury. Additionally, there may be severe property damage.

 **Caution** Indicates a potentially hazardous situation which, if not avoided, may result in minor or moderate injury, or property damage.

OMRON Product References

All OMRON products are capitalized in this manual. The word “Unit” is also capitalized when it refers to an OMRON product, regardless of whether or not it appears in the proper name of the product.

The abbreviation “Ch,” which appears in some displays and on some OMRON products, often means “word” and is abbreviated “Wd” in documentation in this sense.

The abbreviation “PLC” means Programmable Controller. The abbreviation “PC,” however, is used in some Programming Device displays to mean Programmable Controller.

Visual Aids

The following headings appear in the left column of the manual to help you locate different types of information.

Note Indicates information of particular interest for efficient and convenient operation of the product.

© OMRON, 2003

All rights reserved. No part of this publication may be reproduced, stored in a retrieval system, or transmitted, in any form, or by any means, mechanical, electronic, photocopying, recording, or otherwise, without the prior written permission of OMRON.

No patent liability is assumed with respect to the use of the information contained herein. Moreover, because OMRON is constantly striving to improve its high-quality products, the information contained in this manual is subject to change without notice. Every precaution has been taken in the preparation of this manual. Nevertheless, OMRON assumes no responsibility for errors or omissions. Neither is any liability assumed for damages resulting from the use of the information contained in this publication.









■ General Precautions

The user must operate the product according to the performance specifications described in the operation manuals.

Before using the product under conditions which are not described in the manual or applying the product to nuclear control systems, railroad systems, aviation systems, vehicles, combustion systems, medical equipment, amusement machines, safety equipment, and other systems, machines, and equipment that may have a serious influence on lives and property if used improperly, consult your OMRON representative.

Make sure that the ratings and performance characteristics of the product are sufficient for the systems, machines, and equipment, and be sure to provide the systems, machines, and equipment with double safety mechanisms.

■ Transportation, Installation, Wiring, and Maintenance Precautions

-  **WARNING** Do not touch the conductive parts such as internal PCBs or terminal blocks while power is being supplied. Doing so may result in electrical shock.
-  **WARNING** Turn ON the input power supply only after mounting the front cover, terminal covers, bottom cover, Operator, and optional items. Leave them mounted in place while power is being supplied. Not doing so may result in electrical shock, malfunction, or damage to the product.
-  **WARNING** Wiring, maintenance, or inspection must be performed by authorized personnel. Not doing so may result in electrical shock or fire.
-  **WARNING** Wiring, maintenance, or inspection must be performed after turning OFF the power supply, confirming that the CHARGE indicator (or status indicators) is OFF, and after waiting for the time specified on the Inverter front cover. Not doing so may result in electrical shock.
-  **WARNING** Do not damage, pull on, apply stress to, place heavy objects on, or pinch the cables. Doing so may result in electrical shock, operation stoppage, or burning.
-  **WARNING** Install devices to stop operation as required to ensure safety. Equipment damage may result. This is particularly important when operation is set to continue for communications errors because the Inverter will continue operation.
-  **WARNING** Do not attempt to disassemble or repair the Unit. Doing either of these may result in electrical shock, injury, or damage to the product.
-  **Caution** Do not store, install, or operate the product in the following places. Doing so may result in electrical shock, fire or damage to the product.
 - Locations subject to direct sunlight.
 - Locations subject to temperatures or humidity outside the range specified in the specifications.

- Locations subject to condensation as the result of severe changes in temperature.
- Locations subject to corrosive or flammable gases.
- Locations subject to exposure to combustibles.
- Locations subject to dust (especially iron dust) or salts.
- Locations subject to exposure to water, oil, or chemicals.
- Locations subject to shock or vibration.

 **Caution** Do not allow foreign objects to enter inside the product. Doing so may result in fire or malfunction.

 **Caution** Do not apply any strong impact. Doing so may result in damage to the product or malfunction.

 **Caution** Be sure to wire correctly and securely. Not doing so may result in injury or damage to the product.

 **Caution** Be sure to firmly tighten the screws on the terminal block. Not doing so may result in fire, injury, or damage to the product.

 **Caution** Carefully handle the product because it uses semiconductor elements. Careless handling may result in malfunction.

 **Caution** Take appropriate and sufficient countermeasures when installing systems in the following locations. Not doing so may result in equipment damage.

- Locations subject to static electricity or other forms of noise.
- Locations subject to strong electromagnetic fields and magnetic fields.
- Locations subject to possible exposure to radioactivity.
- Locations close to power supplies.

■ Operation and Adjustment Precautions

 **Caution** Do not carelessly change Inverter's settings. Doing so may result in injury or damage to the product.

 **Caution** Install devices to stop operation as required to ensure safety. Equipment damage may result. This is particularly important when operation is set to continue for communications errors because the Inverter will continue operation.

 **Caution** Be sure to perform the setting switch settings correctly and confirm the settings before starting operation. Not doing so may result in malfunction or damage to the product.

■ Reference Manuals

Information on connected devices is required to operate the DeviceNet Communications Unit/Card. Refer to the following manuals for information on related products.

Inverter Manuals

Name	Cat. No.
SYSDRIVE 3G3MV Multi-function Compact Inverters User's Manual	I527
SYSDRIVE 3G3RV High-function General-purpose Inverters User's Manual	I532
SYSDRIVE 3G3FV High-function General-purpose Inverters User's Manual	I516

Note Refer to the user's manual for the Inverter for information on Inverter operation.

DeviceNet Manuals

Name	Cat. No.
DeviceNet Operation Manual	W267
DeviceNet Configurator Operation Manual (Version 2.□)	W382
CS/CJ Series DeviceNet Unit Operation Manual	W380
DeviceNet DRT2 Series Slaves Operation Manual	W404

Note Refer to the *DeviceNet Operation Manual* for details on the DeviceNet network.

Read and Understand this Manual

Please read and understand this manual before using the product. Please consult your OMRON representative if you have any questions or comments.

Warranty and Limitations of Liability

WARRANTY

OMRON's exclusive warranty is that the products are free from defects in materials and workmanship for a period of one year (or other period if specified) from date of sale by OMRON.

OMRON MAKES NO WARRANTY OR REPRESENTATION, EXPRESS OR IMPLIED, REGARDING NON-INFRINGEMENT, MERCHANTABILITY, OR FITNESS FOR PARTICULAR PURPOSE OF THE PRODUCTS. ANY BUYER OR USER ACKNOWLEDGES THAT THE BUYER OR USER ALONE HAS DETERMINED THAT THE PRODUCTS WILL SUITABLY MEET THE REQUIREMENTS OF THEIR INTENDED USE. OMRON DISCLAIMS ALL OTHER WARRANTIES, EXPRESS OR IMPLIED.

LIMITATIONS OF LIABILITY

OMRON SHALL NOT BE RESPONSIBLE FOR SPECIAL, INDIRECT, OR CONSEQUENTIAL DAMAGES, LOSS OF PROFITS OR COMMERCIAL LOSS IN ANY WAY CONNECTED WITH THE PRODUCTS, WHETHER SUCH CLAIM IS BASED ON CONTRACT, WARRANTY, NEGLIGENCE, OR STRICT LIABILITY.

In no event shall the responsibility of OMRON for any act exceed the individual price of the product on which liability is asserted.

IN NO EVENT SHALL OMRON BE RESPONSIBLE FOR WARRANTY, REPAIR, OR OTHER CLAIMS REGARDING THE PRODUCTS UNLESS OMRON'S ANALYSIS CONFIRMS THAT THE PRODUCTS WERE PROPERLY HANDLED, STORED, INSTALLED, AND MAINTAINED AND NOT SUBJECT TO CONTAMINATION, ABUSE, MISUSE, OR INAPPROPRIATE MODIFICATION OR REPAIR.

Application Considerations

SUITABILITY FOR USE

OMRON shall not be responsible for conformity with any standards, codes, or regulations that apply to the combination of products in the customer's application or use of the products.

At the customer's request, OMRON will provide applicable third party certification documents identifying ratings and limitations of use that apply to the products. This information by itself is not sufficient for a complete determination of the suitability of the products in combination with the end product, machine, system, or other application or use.

The following are some examples of applications for which particular attention must be given. This is not intended to be an exhaustive list of all possible uses of the products, nor is it intended to imply that the uses listed may be suitable for the products:

- Outdoor use, uses involving potential chemical contamination or electrical interference, or conditions or uses not described in this manual.
- Nuclear energy control systems, combustion systems, railroad systems, aviation systems, medical equipment, amusement machines, vehicles, safety equipment, and installations subject to separate industry or government regulations.
- Systems, machines, and equipment that could present a risk to life or property.

Please know and observe all prohibitions of use applicable to the products.

NEVER USE THE PRODUCTS FOR AN APPLICATION INVOLVING SERIOUS RISK TO LIFE OR PROPERTY WITHOUT ENSURING THAT THE SYSTEM AS A WHOLE HAS BEEN DESIGNED TO ADDRESS THE RISKS, AND THAT THE OMRON PRODUCTS ARE PROPERLY RATED AND INSTALLED FOR THE INTENDED USE WITHIN THE OVERALL EQUIPMENT OR SYSTEM.

PROGRAMMABLE PRODUCTS

OMRON shall not be responsible for the user's programming of a programmable product, or any consequence thereof.

Disclaimers

CHANGE IN SPECIFICATIONS

Product specifications and accessories may be changed at any time based on improvements and other reasons.

It is our practice to change model numbers when published ratings or features are changed, or when significant construction changes are made. However, some specifications of the products may be changed without any notice. When in doubt, special model numbers may be assigned to fix or establish key specifications for your application on your request. Please consult with your OMRON representative at any time to confirm actual specifications of purchased products.

DIMENSIONS AND WEIGHTS

Dimensions and weights are nominal and are not to be used for manufacturing purposes, even when tolerances are shown.

PERFORMANCE DATA

Performance data given in this manual is provided as a guide for the user in determining suitability and does not constitute a warranty. It may represent the result of OMRON's test conditions, and the users must correlate it to actual application requirements. Actual performance is subject to the OMRON Warranty and Limitations of Liability.

ERRORS AND OMISSIONS

The information in this manual has been carefully checked and is believed to be accurate; however, no responsibility is assumed for clerical, typographical, or proofreading errors, or omissions.

Table of Contents

Chapter 1. Functions and System Configuration	1-1
1-1 Functions	1-2
1-2 Overview of Smart Slave Functions	1-5
1-3 Comparison to Earlier Models	1-8
1-4 DeviceNet Features	1-11
1-5 DeviceNet System Configuration	1-13
Chapter 2. Example System Startup	2-1
2-1 Basic Procedures and Configuration Examples	2-2
2-2 Preparations	2-4
2-3 Setting and Wiring Hardware	2-6
2-4 Starting Communications	2-10
2-5 Checking Operation	2-13
Chapter 3. Setup and Wiring	3-1
3-1 Nomenclature and Settings	3-2
3-2 Installation and Wiring	3-6
3-3 Communications Line Noise Prevention	3-20
3-4 Conformity to EC Directives	3-25
Chapter 4. SYSDRIVE Inverter Settings	4-1
4-1 SYSDRIVE 3G3MV Settings	4-2
4-2 SYSDRIVE 3G3RV and 3G3PV Settings	4-6
4-3 SYSDRIVE 3G3FV Settings	4-10
Chapter 5. Remote I/O Functions	5-1
5-1 Overview of Remote I/O Functions	5-2
5-2 Switching the Remote I/O Function	5-5
5-3 Basic Remote I/O	5-9
5-4 Standard Remote I/O	5-12
5-5 Special Remote I/O Operation	5-15
5-6 Control Remote I/O Operation	5-20
5-7 Unit Status	5-30
Chapter 6. Message Communications	6-1
6-1 Overview of Message Communications	6-2
6-2 Sending Messages from an OMRON PLC	6-4
6-3 Overview of Messages and Responses	6-7
6-4 Motor Data Objects: Class 28 Hex	6-8
6-5 Control Supervisor Objects: Class 29 Hex	6-10
6-6 AC/DC Drive Objects: Class 2A Hex	6-13
6-7 Reading and Writing Parameters: Class 64 Hex	6-18

Table of Contents

Chapter 7. Configurator Settings	7-1
7-1 Basic Configurator Operations	7-2
7-2 Smart Slave Functions	7-9
7-3 Edit Device Parameters Window	7-48
7-4 Monitor Device Window	7-55
7-5 Maintenance Information Window	7-63
Chapter 8. Communications Errors	8-1
8-1 Communications Line Errors	8-2
8-2 Message Communications Errors	8-4
8-3 Special Remote I/O Errors	8-6
8-4 Inverter Faults	8-8
8-5 Inverter Alarms	8-12
Chapter 9. Communications Programs (CS-series PLCs)	9-1
9-1 Standard Remote I/O Programming	9-2
9-2 Message Communications Programming	9-5
9-3 Special Remote I/O Programs	9-13
Chapter 10. Appendices	10-1
10-1 Specifications	10-2
10-2 Objects	10-4
10-3 DeviceNet Communications Response Time	10-27
10-4 3G3MV Register Numbers, Classes, Instances, and Attributes	10-30
10-5 3G3RV Register Numbers, Classes, Instances, and Attributes	10-42
10-6 3G3PV Register Numbers, Classes, Instances, and Attributes	10-66
10-7 3G3FV Register Numbers, Classes, Instances, and Attributes	10-84
Revision History	R-1

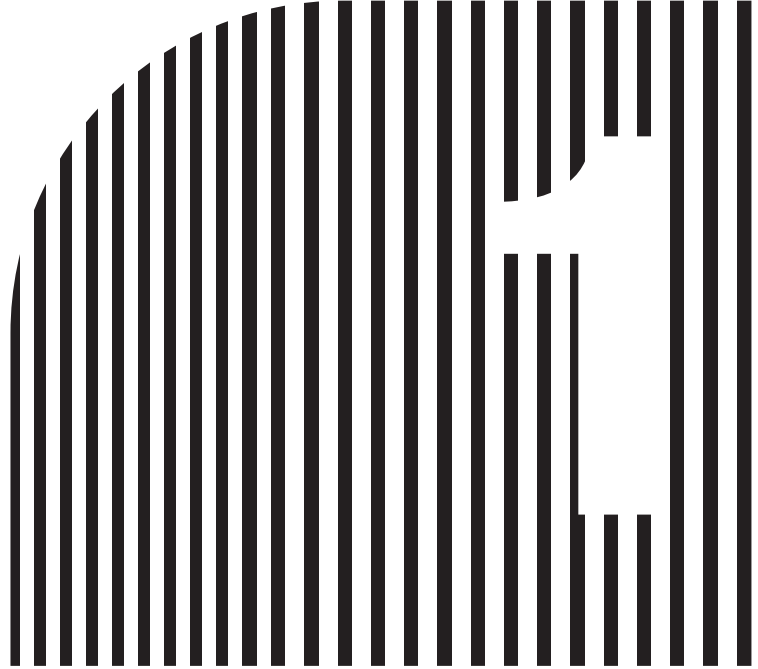

Chapter 1

Functions and System Configuration

- 1-1 Functions
- 1-2 Overview of Smart Slave Functions
- 1-3 Comparison to Earlier Models
- 1-4 DeviceNet Features
- 1-5 DeviceNet System Configuration

1-1 Functions

The 3G3MV-PDRT2 DeviceNet Communications Unit is a DeviceNet communications interface Unit for the SYSDRIVE 3G3MV Multi-function Compact Inverters. The 3G3RV-PDRT2 DeviceNet Communications Card is a DeviceNet communications interface card for the SYSDRIVE 3G3RV and 3G3FV High-function General-purpose Inverters.

The DeviceNet Communications Unit and Card are dedicated communications interface devices that make it possible for the SYSDRIVE 3G3MV, 3G3RV, 3G3PV, and 3G3FV Inverters to communicate with OMRON PLCs. Installing a DeviceNet Communications Unit/Card in the SYSDRIVE Inverter allows a variety of operations to be performed from the Programmable Controller, such as monitoring RUN/STOP and operating conditions and changing set values.

Note When a DeviceNet Communications Unit/Card is used, the RS-422/485 of the Inverter cannot be used for communications.

■ Easy Communications

The following two functions can be used simultaneously in DeviceNet communications between the CPU Unit of a PLC and the Inverter.

- Remote I/O Communications

I/O is automatically transferred between a Slave (SYSDRIVE Inverter) and the CPU Unit without any special programming in the CPU Unit. (Automatically transmits Inverter control inputs such as RUN or STOP from a PLC to the Inverter and returns operation status of the Inverter or output frequency monitor data from the Inverter to the PLC.)

- Message Communications

Message communications are performed between a CPU Unit to which a DeviceNet (Master) Unit is mounted and Slaves (SYSDRIVE Inverters) by executing specific instructions (such as CMND and IO-WR, depending on the model of PLC used) from the program in the CPU Unit. (Allows some parameter setting and monitoring, Inverter output frequency, output voltage, or output current. If the remote I/O communications is not performed, Inverter control data such as RUN or STOP can be input through this message communications function.)

Remote I/O communications for the DeviceNet Communications Unit/Card are performed using either 4 or 8 words allocated in the I/O Area of the PLC. The Inverter can be controlled using remote I/O communications because the basic control I/O functions, frequency setting functions, and output frequency monitoring functions are assigned to remote I/O. This allows the Inverter to be controlled through simple I/O processing.

■ Communications with CS/CJ-series, C200HX/HG/HE, and CVM1/CV-series PLCs

The DeviceNet communications system is supported by CS/CJ-series, C200HX/HG/HE(-Z) and CVM1/CV-series Programmable Controllers. More than twice as many Inverters can be connected in comparison to SYSMAC BUS Remote I/O Systems to support even larger control systems.

Note 1. The maximum number of nodes that can be connected to the system depends on the type of DeviceNet (Master) Unit used, whether the message function is used, and the number of words used by remote I/O communications. See *1-5 DeviceNet System Configuration* for further details.

Note 2. The CS Series includes the CS1G-CPU□□H, CS1H-CPU□□H, CS1G-CPU□□(-V1), and CS1H-CPU□□(-V1) Programmable Controllers. The CJ Series includes the CJ1G-CPU□□H, CJ1H-CPU□□H, CJ1M-CPU□□, and CJ1G-CPU□□ Programmable Controllers. The CVM1/CV Series includes the CV1000, CV2000, and CVM1 Programmable Controllers.

Note 3. C200HS PLCs support only remote I/O communications; they do not support message communications.

■ Multi-vendor Network

The DeviceNet conforms to the DeviceNet open field network specification, which means that devices (Masters and Slaves) produced by other manufacturers can also be connected to the Network. The DeviceNet Communications Unit supports the DeviceNet AC/DC drive object.

■ Choice of Communications Functions

The DeviceNet Communications Unit/Card has various functions to choose from to suit the Inverter applications.

- Supported Master Communications Methods

The DeviceNet Unit/Card supports 4 DeviceNet I/O connection methods: Poll, Bit Strobe, Cyclic, and Change of State (COS). It is possible to set another connection method to be used simultaneously in addition to the regular Poll connection. The COS method is a function that sends with a high priority status only when there has been a change in the status of the Unit's ON/OFF data, so the communications volume is normally zero. The COS communication method is ideal for applications such as error or alarm notifications.

- Remote I/O Communications

- Basic Remote I/O: These are the basic remote I/O functions defined in DeviceNet Specification.
- Standard Remote I/O: These are the factory settings for the DeviceNet Communications Unit/Card. These settings are for DeviceNet compatibility.
- Special Remote I/O: These functions provide compatibility with earlier models (3G3MV-PDRT1-SINV1 and 3G3FV-PDRT1-SINV1).
- Control I/O Remote I/O: These remote I/O functions support the functions and arrays that control the I/O signals of SYSDRIVE Inverters. (These are proprietary OMRON functions and are not part of the DeviceNet specifications.)
- Unit Status: These 16 bits of data (a proprietary OMRON function) include information on the Inverter's fault code and the status of the monitoring functions. We recommend using this remote I/O function with the COS communications method.
- Multi-function Input Monitor: This information is the result of a logical OR between the Inverter's terminal block and the control I/O remote I/O's multi-function input signals. This function can be used to monitor references to the various Inverter functions. Also, if a terminal block signal is set not to function in the Inverter's parameters, the Inverter's terminal block can be used for sensor inputs to the ladder program.

- Message Communications

Inverter control and monitoring are possible with DeviceNet explicit messages. (Messages conforming to the DeviceNet AC/DC driver specifications can be used.)

The Parameter Read message (Class 64), which is a special OMRON function, can be used to read the current value register in the Inverter. Message communications operate independently of the remote I/O functions, so message communications and data that is not allocated to remote I/O can be used simultaneously with the remote I/O functions.

■ Applicable to Various System Configurations

Remote I/O communications and message communications are available as communications functions. Normal control inputs are controlled by the remote I/O communications function. When necessary, the message communications function is used to monitor each Inverter. It is possible to control the selection of either the communications control input or local control input.

Note When connecting the DeviceNet Communications Unit/Card of the Inverter, use DCA1-5C10 Thin Cables and branch them from the T-branch Tap.

■ System Overview

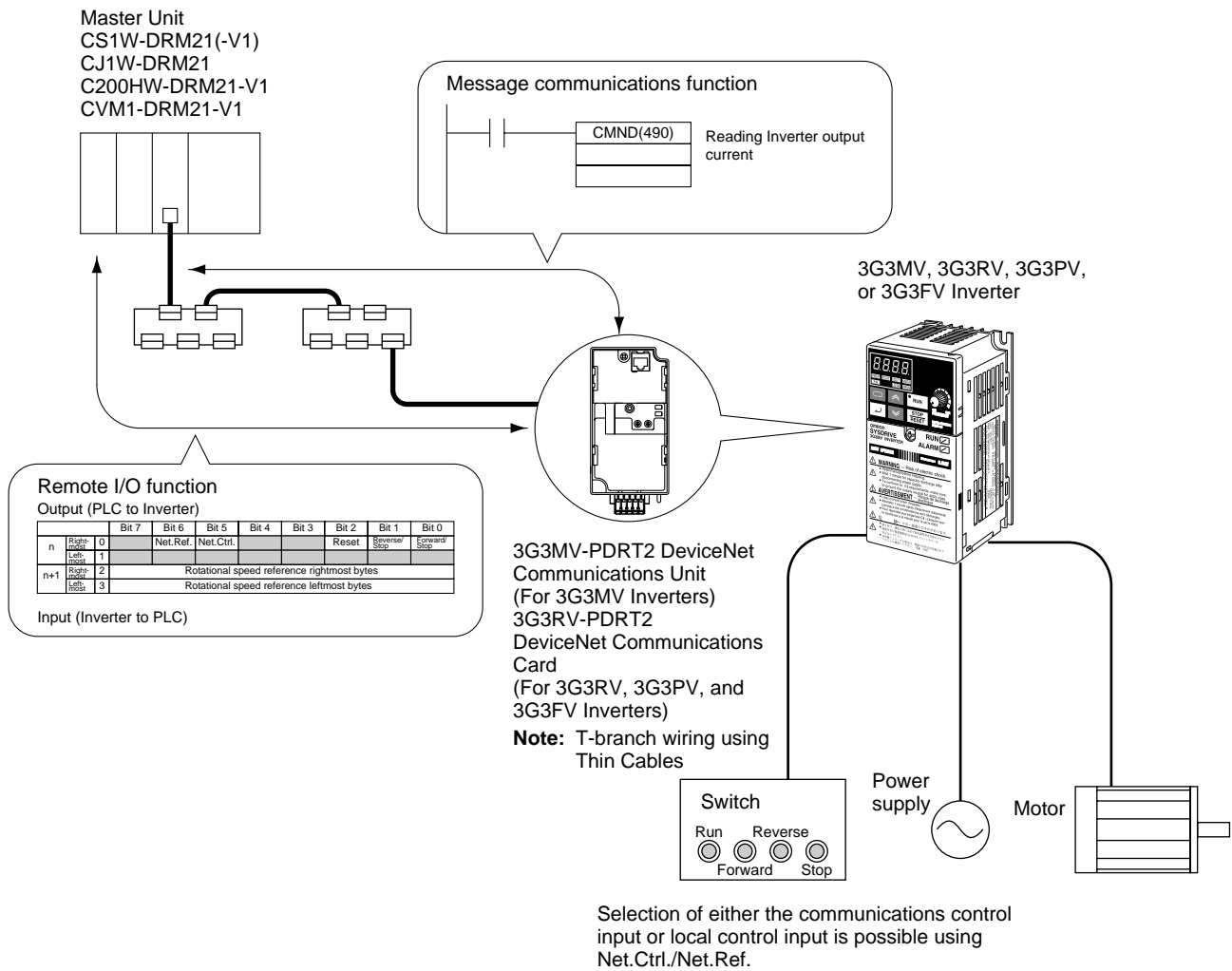

1-2 Overview of Smart Slave Functions

As a Smart Slave, the DeviceNet Communications Unit/Card (3G3MV-PDRT2 or 3G3RV-PDRT2) is equipped with new Smart Slave functions. This chapter introduces the Smart Slave functions. Refer to 7-2 *Smart Slave Functions* for more details and setting/monitoring procedures.

■ Average Power Monitor Function

This function monitors the power that the Inverter supplies each hour and determines the cumulative power usage from the hourly average. The amount of power used by the system can be obtained without using special sensors or performing any calculations. In addition, monitoring the power usage can help reduce energy usage and identify power consumption problems in the system.

The average power can be easily monitored from a Configurator, Programmable Terminal (NS Series), or other operator interface.

■ Warning Torque Detection Function

This function can detect equipment errors by monitoring the output current.

Problems in the load can be detected in the Inverter's current (torque) level. The function provides advanced warning of an increased load caused by deterioration in the mechanical system (such as a loose chain, low bearing oil, or worn-out equipment), so preventative maintenance can be performed.

Note This function generates a warning (alarm), so operation will continue.

■ Current Trace Function

This function traces (samples and records) the output current waveform to the motor. Troubleshooting can be performed easily, without connecting measuring equipment. The Configurator can be used to set the current trace's trigger setting, set the sampling cycle, and display the current waveform.

■ Operating Time Monitor Function

This function can perform a high-speed calculation in the Slave (independent of the ladder program) to determine the time required for an input to go ON after a particular signal or reference goes ON. The Slave can report (through the Unit status flags) when the operating time exceeds the SV set in the Slave.

■ Cumulative ON Time Monitor Function

This function totals the time that one of the Inverter's control I/O terminals is ON. For example, if the RUN output's ON time is totaled, it is possible to calculate the Inverter's operating time and monitor equipment operating time without using the ladder program.

Note The input from the Inverter's control terminal block is ORed with the input from DeviceNet communications, so the input is considered ON when either input source is ON. For example, when either the RUN/STOP signal is input from the control terminal block or the input is being received from DeviceNet communications, the corresponding multi-function input terminal is considered as ON and the ON time is added.

■ Contact Operations Monitor Function

This function counts the number of times that one of the Inverter's control I/O terminals goes ON/OFF. The number of ON/OFF operations can be useful in maintenance, e.g., it can indicate when a connected device needs to be replaced.

Note The input from the Inverter's control terminal block is ORed with the input from DeviceNet communications, just as it is in the Cumulative ON Time Monitor Function.

■ Conduction Time Monitor Function

Totals and records the time that power is supplied to the Slave's internal circuit power supply. The Slave can report (through the Unit status flags) when the cumulative ON time reaches the SV set in the Slave. The DeviceNet Communications Unit/Card has three set values that can be set independently for the following three time monitoring functions.

- Main Unit operating time
- Fan operating time
- Electrolytic capacitor operating time

Since the fan operating time and electrolytic capacitor operating time are used to indicate when those parts need to be replaced, these monitoring times can be reset to zero (with an operation in the Configurator's Device Monitor Window).

■ Baud Rate Auto-detection

In earlier Slaves it was necessary to set the baud rate with a DIP switch on the Slave, but it isn't necessary to set the baud rate for Smart Slaves. The baud rate is automatically set to match the Master's baud rate.

■ Network Power Supply Voltage Monitor Function

The network power supply values (present value, maximum value, and minimum value) can be recorded in the Slave. In addition, the Slave can report (through the Unit status flags) when the voltage drops below the SV (monitor voltage) set in the Slave.

■ Unit Comment Function

An user-defined name can be set for each Unit and the names can be stored in the Slaves.

■ Connected Device Comment Function

User-defined names can be set for the motor connected to the Inverter and devices connected to control I/O terminals, and those names can be stored in the Inverter.

■ **Communications Error Log Monitor Function**

The error status (communications error source code and communications power supply voltage at the time) for the last four communications errors can be recorded in the Slave.

■ **Last Maintenance Date (Maintenance Function)**

The date of the last maintenance can be written in the Unit.

■ **Parameter Setting Function**

The Inverter's user parameters can be set with the Configurator. There are two ways to set the parameters, as follows:

- Several of the major parameters can be displayed and set.
- An individual parameter's Instance/Attribute can be specified and set.

1-3 Comparison to Earlier Models

The following table shows the functions that have been added to the DeviceNet Communications Unit/Card (3G3MV-PDRT2 and 3G3RV-PDRT2), which are not available in the earlier DeviceNet Communications Unit/Card (3G3MV-PDRT1-SIN□ and 3G3FV-PDRT1-SIN□).

Refer to the Chapter in the “Reference” column for more details on each function.

■ Function Comparison Table

Category	Function		New Unit/Card (□-PDRT2)	Earlier Unit/Card (□-PDRT1-SIN□)	Reference
Remote I/O	I/O allocation	Basic I/O	Supported	Supported	Chapter 5
		Standard I/O	Supported	Supported	
		Advanced I/O	Supported	Supported	
		Control I/O	Supported (Advanced Function)	Supported	
		Unit Status	Supported (Advanced Function)	Not supported	
		Multi-function Input Monitor	Supported (Advanced Function)	Not supported	
DeviceNet Master connectivity	Connection type	Poll	Supported	Supported	Chapter 5
		Bit strobe	Supported	Not supported	
		Change of state	Supported (Advanced Function)	Not supported	
		Cyclic	Supported	Not supported	
	Connection path switching (Selecting I/O allocation in Master's parameters)		Supported	Supported	
	Default connection path switching (Selecting the I/O allocation in the Slave when power goes ON)		Supported (Advanced Function)	Supported	
	Baud rate auto-detect (Baud rate set automatically.)		Supported	Not supported	Chapter 7
Inverter	Parameter settings		Supported (Advanced Function)	Supported	See note.

Category	Function	New Unit/Card (□-PDRT2)	Earlier Unit/Card (□-PDRT1-SIN□)	Reference
Smart Slave functions	Average Power Monitor Function	Supported (Advanced Function)	Not supported	Chapter 7
	Warning Torque Detection Function	Supported (Advanced Function)	Not supported	
	Current Trace Function	Supported (Advanced Function)	Not supported	
	Operating Time Monitor Function	Supported (Advanced Function)	Not supported	
	Cumulative ON Time Monitor Function	Supported (Advanced Function)	Not supported	
	Contact Operations Monitor Function	Supported (Advanced Function)	Not supported	
	Conduction Time Monitor Function	Supported (Advanced Function)	Not supported	
	Network Power Supply Voltage Monitor Function	Supported	Not supported	
	Unit Comment Function	Supported	Not supported	
	Connected Device Comment Function	Supported	Not supported	
	Communications Error Log Monitor Function	Supported	Not supported	
	Last Maintenance Date (Maintenance Function)	Supported	Not supported	

Note Refer to 7-3 *Edit Device Parameters Window* for details on setting parameters with the Configurator.
refer to 5-5 *Special Remote I/O Operation* for details on setting parameters with special remote I/O.
Refer to 6-7 *Reading and Writing Parameters: Class 64 Hex* for details on setting parameters with message communications.
Refer to *Chapter 10 Appendices* for reference data such as register numbers, which are required when setting parameters. The information is organized by Inverter series.

■ **Comparison of Installation Specifications**

The installation conditions for the 3G3MV-PDRT2 have changed in comparison to those for the 3G3MV-PDRT1-SINV(1). Observe the following precautions when changing models.

- Install the Unit into a metal panel.
The EMC immunity of the 3G3MV-PDRT2 is somewhat less than that of the 3G3MV-PDRT1-SINV(1). Refer to 3-4 *Conformity to EC Directives* for information on electromagnetic wave countermeasures.
- The installation dimension at the bottom has been increased by 7 mm.

The 3G3MV-PDRT2 is equipped with a connector for DeviceNet connection rather than a terminal block. The dimension of the connector that extends below the case must be added.

■ Inverter Software Versions

Supported software versions are listed in the following table.

Model	Software version	Release date	Description
3G3MV Series, 3.7 kW and less	VSP010027 (S0027) and higher	June 2003	Supports all functions. Current trace function and warning torque detection function use increments of 0.01 A.
	VSP010026 (S0026)	June 2002	Supports all functions.
	VSP010025 (S0025)	June 2001	Current trace function and warning torque detection function are use increments of 0.1 A for detection and display.
	VSP010024 (S0024)	September 2000	
3G3MV Series, 5.5 kW and more	VSP010105 (S0105)	September 2002	Supports all functions.
	VSP010104 (S0104)	May 2001	Current trace function and warning torque detection function are use increments of 0.1 A for detection and display.
3G3RV Series	VSF105081 (S5081) and higher	November 2001	Supports all functions. Current trace function and warning torque detection function are use increments of 0.1 A for detection and display.
3G3PV Series	VSE102014 (S2014)	July 2002	Supports all functions.
	VSE102013 (S2013)	March 2001	Current trace function and warning torque detection function are use increments of 0.1 A for detection and display.
3G3FV Series	VSG101114 (S1114)	September 2002	It is not possible to force-switch the command right from the network. Specifically, even if netref and netctrl (see <i>Chapter 5 Remote I/O Functions</i>) are turned ON, the command right will not be switched to the network. Use parameters b1-02 and b1-01 to set the command right. There are no restrictions to other functions.
	VSG101113 (S1113)	September 2000	
	VSG101043 (S1043)	September 1998	

1-4 DeviceNet Features

■ System Configuration Example

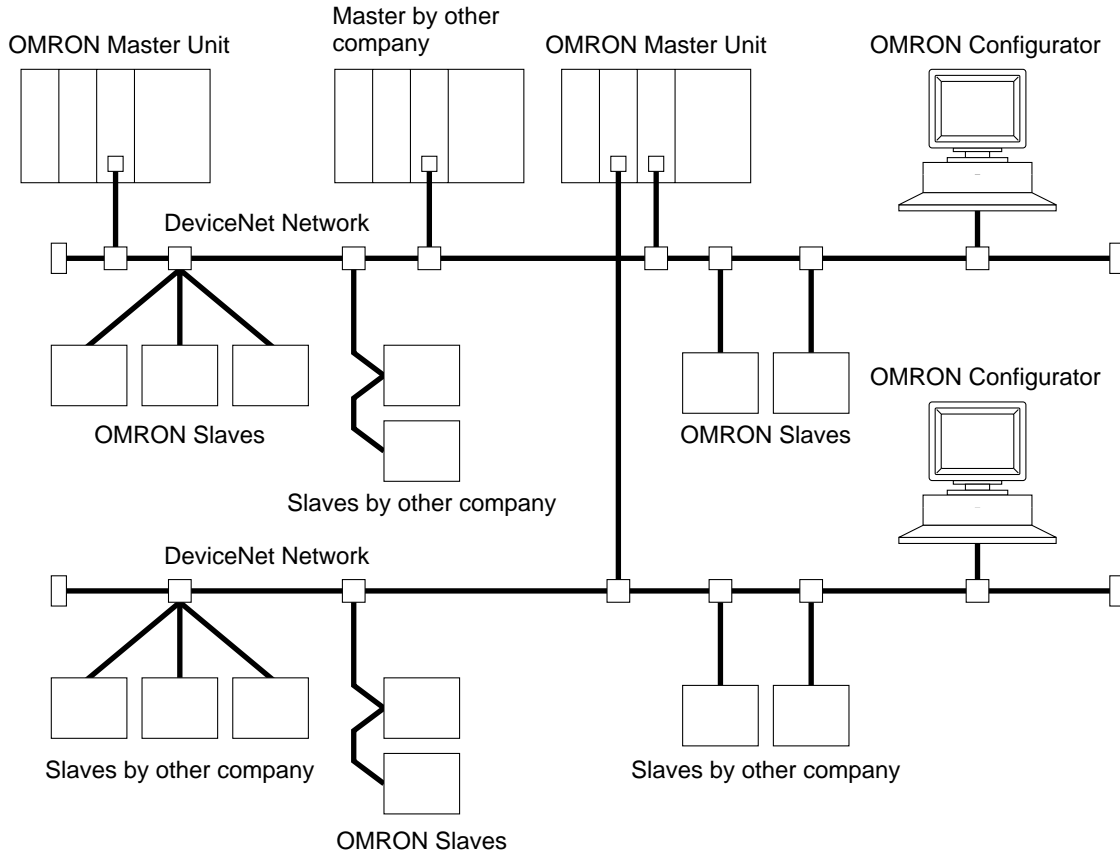

■ Multi-vendor Network

The DeviceNet conforms to the DeviceNet open field network specification, which means that devices (Masters and Slaves) produced by other manufacturers can also be connected to the Network. Therefore, a wide range of field-level applications can be supported by combining valve devices, sensors, and other devices.

■ Simultaneous Remote I/O and Message Services

Remote I/O communications to constantly exchange I/O data between the PLC and Slaves can be executed simultaneously with message communications, to send/receive DeviceNet (Master) Unit data as required by the application. Therefore, a DeviceNet Network can be installed to flexibly handle applications that require both bit data and message data. Message communications can be achieved either by using OMRON's FINS commands or by using DeviceNet explicit messages.

■ Connect Multiple PLCs to the Same Network

A Configurator (sold separately) can be used to enable connection of more than one Master to the Network, allowing message communications between PLCs and between multiple groups of PLCs and Slaves. This allows the DeviceNet Network to be used as a common bus to unify controls while reducing wiring.

■ Handle Multi-point Control and Line Expansions with Multi-layer Networks

A Configurator (sold separately) can be used to enable mounting more than one DeviceNet (Master) Unit to a single PLC, allowing control of many more points. This feature can easily handle line expansions and other applications.

■ Free Remote I/O Allocation

A Configurator (sold separately) can be used to enable flexible allocation of I/O, i.e., in any area and in any order. This allows I/O allocations that suit the application to simplify programming and enable effective usage of PLC memory areas.

■ Handle Slaves with Different Response Speeds

A Configurator (sold separately) can be used to set the communications cycle time, enabling usage of Slaves with slow response times.

■ Easily Expand or Change Lines with Various Connection Methods

Use a multi-drop trunk line, T-branch multi-drop lines, or daisy-chain drop lines. All three connection methods can be combined to flexibly construct a Network that meets the needs of the application.

Note For connecting the DeviceNet Communications Unit of the Inverter, use DCA1-5C10 Thin Cables and branch them from the T-branch Tap.

1-5 DeviceNet System Configuration

1-5-1 System Configuration

DeviceNet is a multi-bit, multi-vendor network that combines controls and data on a machine/line-control level and that conforms to DeviceNet open field network specifications.

Two types of communications are supported: 1) Remote I/O communications that automatically transfer I/O between Slaves and the CPU Unit of a PLC without any special programming in the CPU Unit and 2) Message communications are performed between a CPU Unit to which a DeviceNet (Master) Unit is mounted and Slaves by executing specific instructions (such as CMND and IOWR, depending on the model of PLC used) from the program in the CPU Unit.

A Configurator (sold separately) can be used to enable following. This allows the support of an even larger control system.

- I/O area words can be flexibly allocated for remote I/O communications.
- More than one DeviceNet (Master) Unit can be mounted to a single PLC.
- More than one DeviceNet (Master) Unit can be connected in a single Network.

■ Fixed Allocation: Configuration without a Configurator

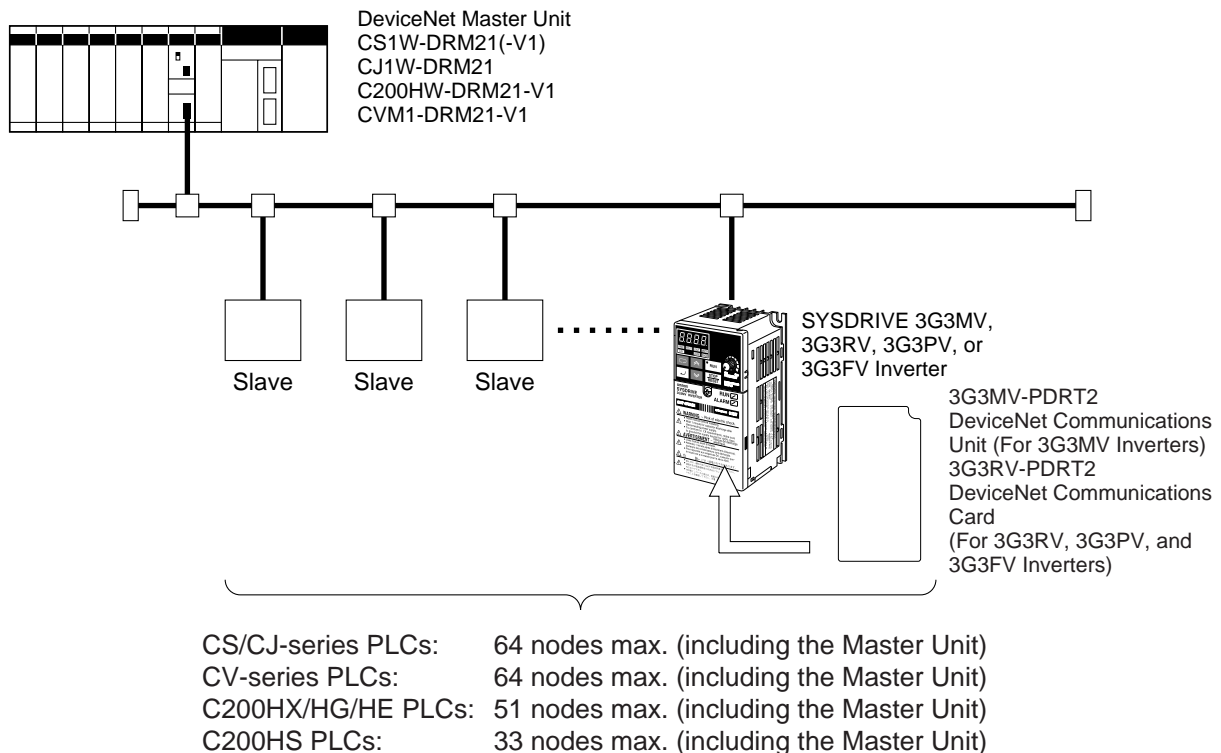

Note 1. The DeviceNet (Master) Unit occupies one node of the DeviceNet Network.

Note 2. If C200HS PLCs are used, only remote I/O communications are possible.

Note 3. If one node uses more than one word, the maximum number of nodes will be reduced by one node for each extra word that is used. (The above numbers of nodes assume that each node is allocated one I/O word.)

■ Free Allocation: Configuration with a Configurator

DeviceNet Master Unit
 CS1W-DRM21(-V1)
 CJ1W-DRM21
 C200HW-DRM21-V1
 CVM1-DRM21-V1

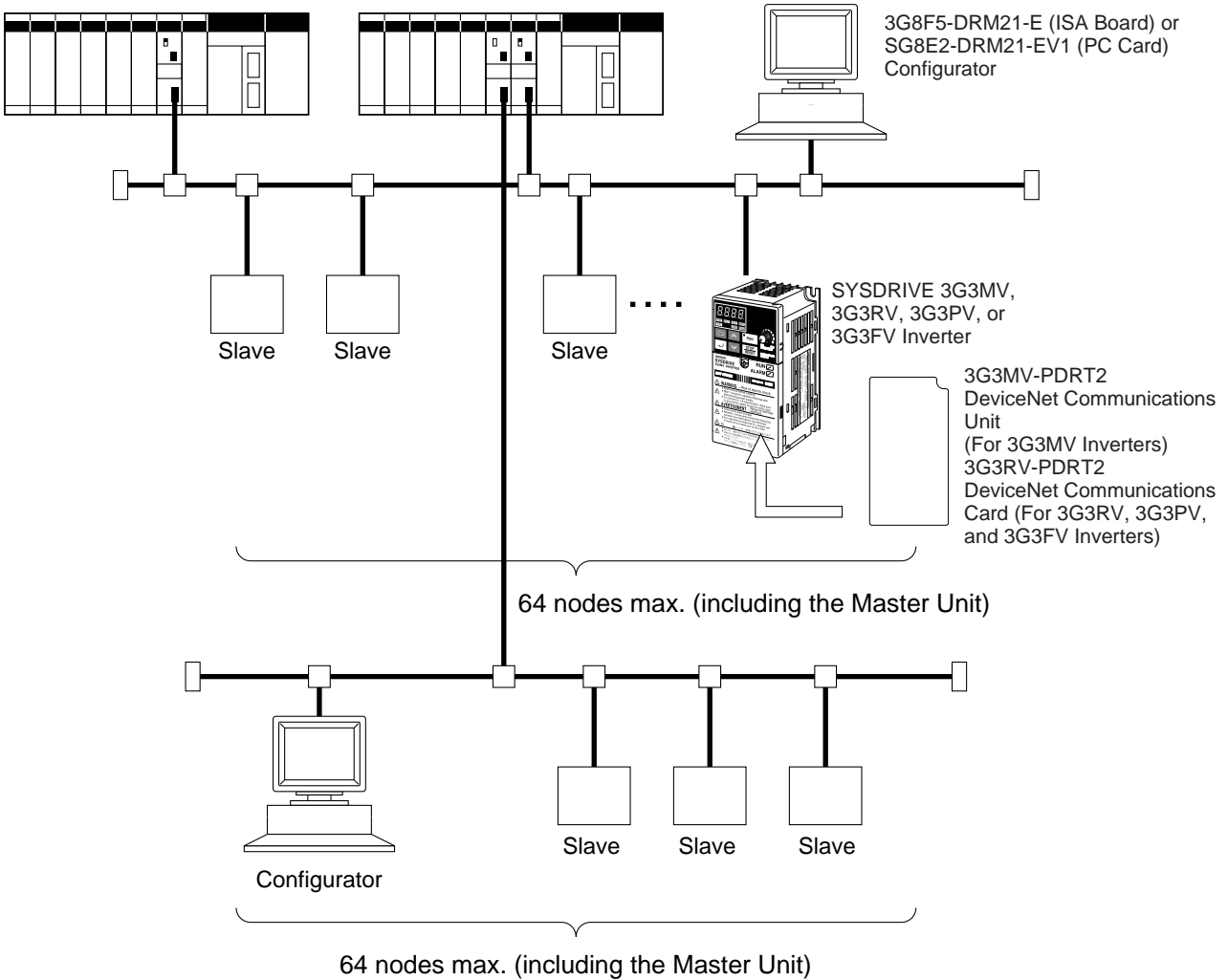

- Note 1.** The DeviceNet (Master) Unit and Configurator each occupy one node of the DeviceNet Network.
- Note 2.** If C200HS PLCs are used, only remote I/O communications are possible.
- Note 3.** The maximum number of nodes that can be connected to the Network will be limited by the maximum number of control points of the PLC used.

1-5-2 Configurator Overview

The Configurator is a software application run on an IBM PC/AT or compatible computer and is used to support a DeviceNet communications system. Connection to the Network is achieved either via a serial communications port (peripheral bus or Host Link) or by connecting the computer directly to the DeviceNet using a hardware interface. The Configurator occupies one node on the DeviceNet Network, but has no specific functions on the network itself. The Configurator provides the following functions.

- Free Allocation of Remote I/O

The remote I/O allocations in the PLCs can be changed from the Configurator. I/O can be flexibly allocated for each node within the specified I/O areas.

- More than One DeviceNet (Master) Unit per Network

Slaves can be set for each DeviceNet (Master) Unit from the Configurator enabling communications between multiple groups of PLCs and Slaves. The maximum number of nodes connected to one Network remains at 64.

Note One Slave can be connected to no more than one DeviceNet (Master) Unit.

- More than one DeviceNet (Master) Unit per PLC

Remote I/O can be allocated for each Slave of the DeviceNet (Master) Unit from the Configurator, so more than one DeviceNet (Master) Unit can be mounted to the same PLC.

Note In allocating Remote I/O for each DeviceNet (Master) Unit, be careful not to allow any dual allocation.

■ Configurator Specifications

Dedicated interface	---	3G8F5-DRM21-E	3G8E2-DRM21-EV1
Software	WS02-CFDC1-E	Packaged with the Interface	
Personal computer	Desktop model or Notebook model	Desktop model (ISA Board)	Notebook model (PCMCIA Card)

Dedicated interface		---	3G8F5-DRM21-E	3G8E2-DRM21-EV1
Operating environment	Compatible OS	Windows 95, 98, ME, NT 4.0, 2000, or XP	Windows 95, 98, ME, or NT 4.0	Windows 95, 98, 2000, or XP
	Minimum computer requirements	IBM PC/AT or compatible (OS requirements may be stricter than the following.) CPU: 166 MHz Pentium min. Memory: 32 MB min. Hard disk: 15 MB min. free space		
Connection method	Dedicated interface	Sold separately	ISA Board	PCMCIA Card
	Serial	Connect from the computer's COM port through a CS/CJ-series PLC. (This connection is possible when a CS/CJ-series DeviceNet (Master) Unit is being used.)		
	Ethernet	Connect from the computer's Ethernet port through a CS/CJ-series PLC's Ethernet. (This connection is possible when a CS/CJ-series DeviceNet (Master) Unit is being used.)		
Relation to Network		<p>Using a dedicated interface: Connect directly to DeviceNet.</p> <ul style="list-style-type: none"> Operates as one node on the Network, requires one node address, and only one Configurator can be connected to the Network. The Configurator can be disconnected from the Network after remote I/O has been allocated. <p>Using a serial or Ethernet connection:</p> <ul style="list-style-type: none"> Possible only when a CS/CJ-series DeviceNet (Master) Unit is being used. A DeviceNet node address is not required. (Connects through the DeviceNet (Master) Unit.) A node address is not allocated, so the Configurator can be connected or disconnected freely. (There are some limitations compared to a direct DeviceNet connection through a dedicated interface. For example, the refreshing interval for PV monitoring is much slower than it is with a direct connection.) 		

1-5-3 DeviceNet Communications Specifications

Item	Specifications
Communications protocol	DeviceNet
Supported connections (communications)	<ul style="list-style-type: none"> Remote I/O Master/Slave connection (Poll, Bit-strobe, COS, or Cyclic) Explicit messages Explicit connection Both conform to DeviceNet specifications.
Connection forms	Combination of multi-drop and T-branch connections (for trunk and drop lines)
Baud rate	500 Kbps, 250 Kbps, or 125 Kbps (switchable)
Communications media	Special 5-wire cables (2 signal lines, 2 power lines, and 1 shield line) <ul style="list-style-type: none"> Thick Cable: DCA2-5C10 (100 m) Thin Cable: DCA1-5C10 (100 m)

Item	Specifications			
	Baud rate	Network length	Drop line length	Total drop line length
Communications distances	500 Kbps	100 m max.	6 m max.	39 m max.
	250 Kbps	250 m max.	6 m max.	78 m max.
	125 Kbps	500 m max.	6 m max.	156 m max.
Communications power supply	24 V DC \pm 1%, supplied externally (Slave power supply: 11 to 25 V DC) Recommended power supply: OMRON S82H Series or S82J Series			
Maximum number of nodes	64 nodes			
Maximum number of Masters	Without Configurator: 1 With Configurator: 63			
Maximum number of Slaves	Without Configurator: 63 With Configurator: 63			
Error control	CRC check			

1-5-4 Inverters

The maximum number of Inverters that can be connected to one Network depends on the PLC model that is used, the remote I/O functions of the Inverter, and whether message communications are used or not. (Use the message communications function for setting some parameters and for monitoring the output current.) The differences between models are provided in the following tables.

■ CS1W-DRM21(-V1) or CJ1W-DRM21 DeviceNet (Master) Units

● Communications without Configurator: Fixed Allocations

Applicable PLC	CS Series	CJ Series
DeviceNet (Master) Unit	CS1W-DRM21(-V1)	CJ1W-DRM21
Supported communications	Remote I/O and messages	
Maximum number of Slaves per DeviceNet (Master) Unit	63	

Applicable PLC		CS Series	CJ Series
Maximum number of controlled points per DeviceNet (Master) Unit		2,048	
Allocation areas		Select one of the following settings, using the software switch (Fixed Area Setting 1, 2, or 3 Switch) in the words allocated to the DeviceNet (Master) Unit in the CIO Area: 1. OUT: CIO 3200 to CIO 3263; IN: CIO 3300 to CIO 3363 (default) 2. OUT: CIO 3400 to CIO 3463; IN: CIO 3500 to CIO 3563 3. OUT: CIO 3600 to CIO 3663; IN: CIO 3700 to CIO 3763	
Allocation method		Words are allocated for each node to the above data areas in node address order only. <ul style="list-style-type: none"> • 8-point Slaves: Allocated 1 word (1 node address) • 16-point Slaves: Allocated 1 word (1 node address) • Slaves with more than 16 points: Allocated multiple words (multiple node addresses) 	
Maximum number of Inverters	Without explicit messages	4 words remote I/O: 32 6 words remote I/O: 21 8 words remote I/O: 16	
	With explicit messages	4 words remote I/O: 32 6 words remote I/O: 21 8 words remote I/O: 16	

● Communications with Configurator: Free Allocations

Applicable PLC	CS Series	CJ Series
DeviceNet (Master) Unit	CS1W-DRM21(-V1)	CJ1W-DRM21
Supported communications	Remote I/O and messages	
Maximum number of Slaves per DeviceNet (Master) Unit	63	

Applicable PLC	CS Series	CJ Series
Maximum number of controlled points per DeviceNet (Master) Unit	Using Settings in Words Allocated in DM Area: 16,000 points (IN: 500 words × 1 block; OUT: 500 words × 1 block) Using Configurator: 32,000 points (IN: 500 words × 2 blocks; OUT: 500 words × 2 blocks)	
Allocation areas	CIO 0000 to CIO 6143 WR: W000 to W511 HR: H000 to H511 DM: D00000 to D32767 EM: E00000 to E32767	
Allocation method	Words are allocated to each node in the above data areas in any order. The following limitations apply: <ul style="list-style-type: none"> • Using Settings in Words Allocated to DeviceNet (Master) Unit in DM Area The following limitations apply when allocating words using settings in the DM Area. <ul style="list-style-type: none"> • Words are allocated in 2 blocks (OUT 1, IN 1). Each block consists of sequential words. • Words for each slave are allocated inside the allocated words in order of node number. (It is not necessary to allocate words to unused node numbers.) • The leftmost byte of a word cannot be allocated to an 8-point Slave. • Using the Configurator Using the Configurator allows much wider allocation than using settings in the DM Area. <ul style="list-style-type: none"> • Words are allocated in 4 blocks (OUT 1, OUT 2, IN 1, IN 2). Each block consists of sequential words. • Words for each slave can be allocated inside the allocated words in any order. • Limitations That Apply to Both Methods The following limitations apply when allocating words using either settings in the DM Area or using the Configurator. <ul style="list-style-type: none"> • The maximum that can be allocated in one block is 500 words. For Slaves with more than 8 points, the first byte cannot be specified as the leftmost byte (7 to 15). • The same Slave cannot be used for more than one DeviceNet (Master) Unit. Words are allocated to Slaves as follows: <ul style="list-style-type: none"> • 8-point Slaves: Allocated leftmost or rightmost byte of a word. • 16-point Slaves: Allocated 1 word. • Slaves with more than 16 points: Allocated multiple words (for Slaves with an odd number of bytes, the last byte will be the rightmost byte). 	
Maximum number of Inverters (using one DeviceNet (Master) Unit only)	63	
Maximum number of Inverters with more than one DeviceNet (Master) Unit	Calculate from the number of words allocated in the data areas and the number of words allocated to the Inverters (4 to 8 words). The DM Area cannot be manipulated by bit, so it cannot be allocated for remote I/O for Inverters.	

■ **C200HW-DRM21-V1 or CVM1-DRM21-V1 DeviceNet (Master) Units**

● **Communications without Configurator: Fixed Allocation**

Applicable PLC		CVM1/CV Series	CS Series and C200HX/HG/HE	C200HS
DeviceNet (Master) Unit		CVM1-DRM21-V1	C200HW-DRM21-V1	
Supported communications		Remote I/O and messages	Remote I/O and messages	Remote I/O
Maximum number of Slaves per DeviceNet (Master) Unit		63	50	32
Maximum number of controlled points per DeviceNet (Master) Unit		2,048	1,600	1,024
Allocation areas		OUT: CIO 1900 to CIO 1963 IN: CIO 2000 to CIO 2063	OUT: IR 050 to IR 099 IN: IR 350 to IR 399	OUT: IR 50 to IR 81 IN: IR 350 to IR 381
Allocation method		Words are allocated for each node to the above data areas in node address order only. <ul style="list-style-type: none"> • 8-point Slaves: Allocated 1 word • 16-point Slaves: Allocated 1 word • Slaves with more than 16 points: Allocated multiple words 		
Maximum number of Inverters	Without explicit messages	4 words remote I/O: 32 6 words remote I/O: 21 8 words remote I/O: 16	4 words remote I/O: 25 6 words remote I/O: 16 8 words remote I/O: 12	4 words remote I/O: 16 6 words remote I/O: 10 8 words remote I/O: 8
	With explicit messages	4 words remote I/O: 32 6 words remote I/O: 21 8 words remote I/O: 16	4 words remote I/O: 25 6 words remote I/O: 16 8 words remote I/O: 12	---

● **Communications with Configurator: Free Allocation**

Applicable PLC		CVM1/CV Series	CS Series and C200HX/HG/HE	C200HS
DeviceNet (Master) Unit		CVM1-DRM21-V1	C200HW-DRM21-V1	
Supported communications		Remote I/O and messages	Remote I/O and messages	Remote I/O
Maximum number of Slaves per DeviceNet (Master) Unit		63	63	63
Maximum number of controlled points per DeviceNet (Master) Unit		6,400 (100 words × 4 blocks)	Without messages: 4,800 With messages: 1,600	1,280 (total of 4 blocks)

Applicable PLC		CVM1/CV Series	CS Series and C200HX/HG/HE	C200HS
Allocation areas		Core I/O Area: CIO 0000 to CIO 2555 CIO 0000 to CIO 2427 for CV500/CVM1-CPU01(-V□)	IR Area 1: IR 000 to IR 235 IR Area 2: IR 300 to IR 511	
		CPU Bus Link Area: G008 to G255	<u>CS Series</u> HR: H000 to H099 CIO: 1000 to 1063 <u>C200HX/HG/HE</u> HR Area: HR 00 to HR 99 LR Area: LR 00 to LR 63	HR Area: HR 00 to HR 99 LR Area: LR 00 to LR 63
		DM Area: D00000 to D24575 D00000 to D08191 for CV500/CVM1-CPU01 (-V□)	<u>CS Series</u> DM: D00000 to D05999 <u>C200HX/HG/HE</u> DM: DM 0000 to DM 5999 (DM 0000 to DM 4095 for C200HE-CPU11-(Z)E)	DM Area: DM 0000 to DM 5999
Allocation method		<p>Words are allocated to each node in the above data areas in any order using the Configurator.</p> <p>The following limitations apply:</p> <ul style="list-style-type: none"> • The allocation areas are in 4 blocks (OUT 1, OUT 2, IN 1, and IN 2). Each block consists of sequential words. • 100 words max. per block. • For Slaves with more than 8 points, the first byte cannot be specified in leftmost bits (7 to 15). <p>Words are allocated to Slaves as follows:</p> <ul style="list-style-type: none"> • 8-point Slaves: Allocated leftmost or rightmost byte of 1 word • 16-point Slaves: Allocated 1 word • Slaves with more than 16-points: Allocated multiple words (For Slaves with an odd number of bytes, the last byte will be the rightmost byte) 		
Maximum number of Inverters (using one DeviceNet (Master) Unit only)	Without explicit messages	63	4 remote I/O words: 63 6 remote I/O words: 50 8 remote I/O words: 37	4 words remote I/O: 20 6 words remote I/O: 13 8 remote I/O words: 10
	With explicit messages	63	4 remote I/O words: 25 6 remote I/O words: 16 8 remote I/O words: 12	---
Maximum number of Inverters with more than one DeviceNet (Master) Unit		<p>Calculate from the number of words allocated in the data areas and the number of words allocated to the Inverters (4 or 6 words).</p> <p>Note 1. The DM Area cannot be manipulated by bit, so it cannot be allocated for remote I/O for Inverters.</p> <p>Note 2. If the CPU Bus Link is used with a CVM1/CV-series PLC, the CPU Bus Link Area will be used for the CPU Bus Link Therefore, the CPU Bus Link Area cannot be allocated to Inverters for use with DeviceNet if the CPU Bus Link is used.</p>		

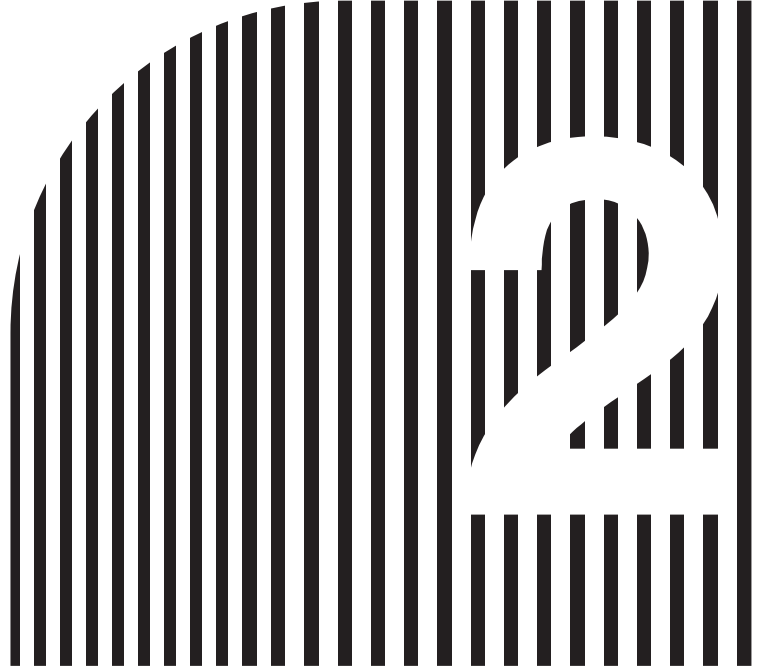

Chapter 2

Example System Startup

- 2-1 Basic Procedures and Configuration Examples
- 2-2 Preparations
- 2-3 Setting and Wiring Hardware
- 2-4 Starting Communications
- 2-5 Checking Operation

2-1 Basic Procedures and Configuration Examples

The examples shown here provide the basic operating procedures for DeviceNet.

2-1-1 Basic Procedures

The following list outlines the basic application procedures. For details on settings and connections, refer to the operation manual for the DeviceNet (Master) Unit. For further details on Slave Units, refer to the operation manual(s) for the Slave Units.

Preparing the Units

1. Select the appropriate Units. Refer to *2-2-1 Selecting Units*.
2. Determine the appropriate wiring method. Refer to *2-2-2 Wiring*.
3. Determine the appropriate method for supplying communications power. Refer to *2-2-3 Communications Power Supply*.

Setting and Wiring Hardware

1. Separate and lay the cables.
2. Mount the DeviceNet (Master) Unit and specify the correct settings. Refer to *2-3-1 Mounting and Setting the DeviceNet (Master) Unit*.
3. Mount the Slave Units and specify the correct settings. Refer to *2-3-2 Mounting and Setting Slaves*.
4. Mount other devices to be connected to the Network. Refer to *2-3-3 Mounting Connecting Devices*.
5. Connect the cables. Refer to *2-3-4 Connecting Cables*.
6. Wire the I/O cables. Refer to *2-3-4 Connecting Cables*.

Starting Communications

1. Create the I/O tables. Refer to *2-4-1 Creating I/O Tables for the DeviceNet (Master) Unit*.
2. Start up the system. Refer to *2-4-2 Starting the System*.
3. Create and register the scan list. Refer to *2-4-3 Creating and Registering Scan Lists*.

Checking Operations

1. Check the status of the indicators on the Unit. Refer to *2-5-1 Indicator Status*.
2. Check that data is reading and writing properly. Refer to *2-5-2 Reading and Writing Data*.

Note The examples provided in this section show the minimum settings needed to operate the system. If details on other settings for actual operation are required, refer to the operation manual for the DeviceNet (Master) Unit and the operation manual(s) for the Slave Units.

2-1-2 System Configuration Example

The following diagram shows the operating procedure using a system configuration example.

The system configuration shown here uses Thin Cables.

The following diagram is simplified, so it does not include the separate I/O power supply that must be provided to the Output Unit (or Expansion Output Unit).

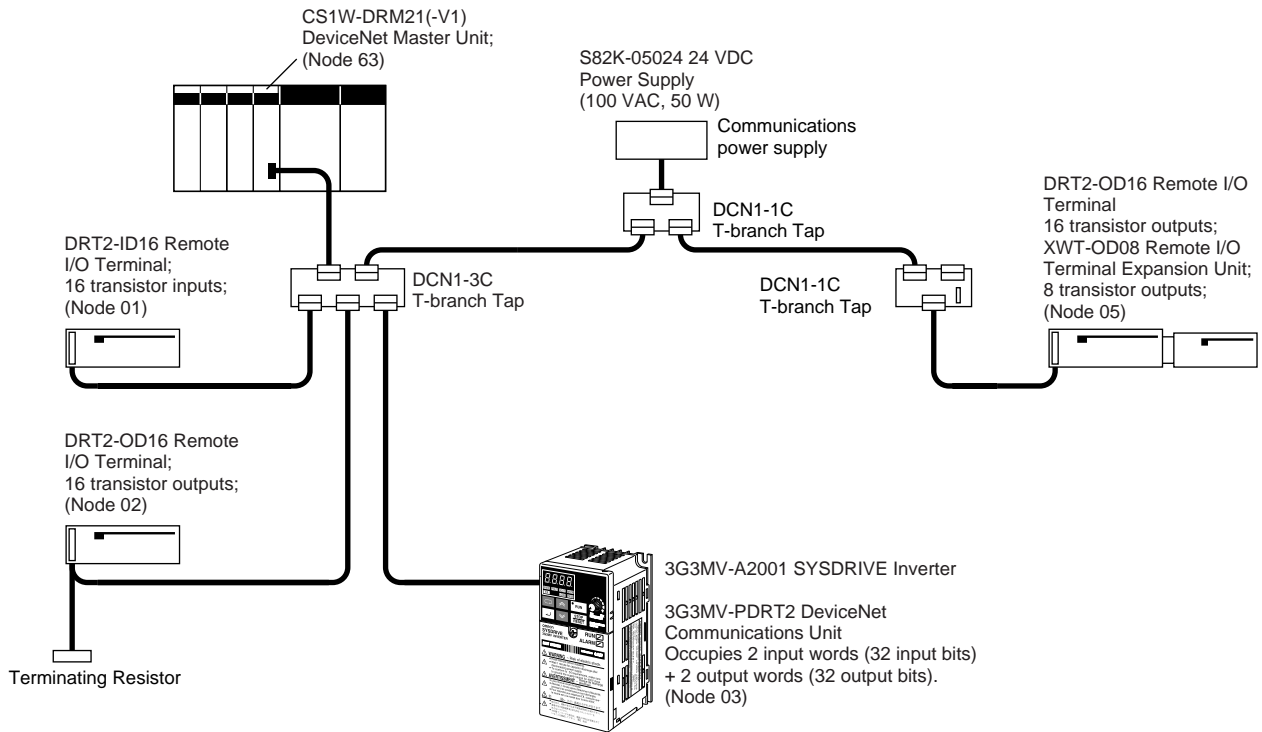

2-2 Preparations

2-2-1 Selecting Units

Select the following Units as shown in *2-1-2 System Configuration Example*.

DeviceNet (Master) Unit:CS1W-DRM21

Slave Units: DRT2-ID16
DRT2-OD16
3G3MV-PDRT2 + 3G3MV-A2001
DRT2-OD16 + XWT-OD08

There is a complete line of OMRON DeviceNet (Master) Units and Slave Units available that are compatible with DeviceNet. Select Units that suit the needs of the system.

2-2-2 Wiring

Either Thick Cables or Thin Cables can be used to wire a DeviceNet Network.

Flexible branching of cables is possible by using either T-branch Taps or multi-drop connections.

Restrictions on the maximum network length and total branch line length depend on the baud rate and type of cable used. For details on network configurations and specifications, refer to the *DeviceNet Operation Manual (W267)*.

Here, Thin Cables are used and T-branch connection are used to connect Slaves to the trunk line, as shown in *2-1-2 System Configuration Example*.

2-2-3 Communications Power Supply

Each node (Master or Slave) must be supplied with a 24-V DC power supply for proper DeviceNet communications.

The communications power, however, can be supplied by communications cables and does not require separate wiring.

For systems that have a short maximum network length, power can be supplied to all nodes by using one communications power supply.

Various conditions, constraints, and measures affect how the communications power is supplied. In the examples shown here, the power is supplied from one communications power supply, and communications cables are connected using T-branch Taps.

For details on methods of supplying communications power, refer to the DeviceNet Operation Manual (W267).

Note Refer to *3-2-5 Making Multi-drop Connections* when using Thick Cables and multi-drop connections for wiring.

2-3 Setting and Wiring Hardware

Use the following procedures to mount, set, and wire the hardware.

2-3-1 Mounting and Setting the DeviceNet (Master) Unit

■ Settings

The components, functions, and switch settings for the CS1W-DRM21(-V1) or CJ1W-DRM21 DeviceNet (Master) Unit mounted to a CS/CJ-series PLC are shown as an example in the following diagram.

For information on switch settings, refer to the operation manual for the DeviceNet (Master) Unit.

■ CS1W-DRM21(-V1)

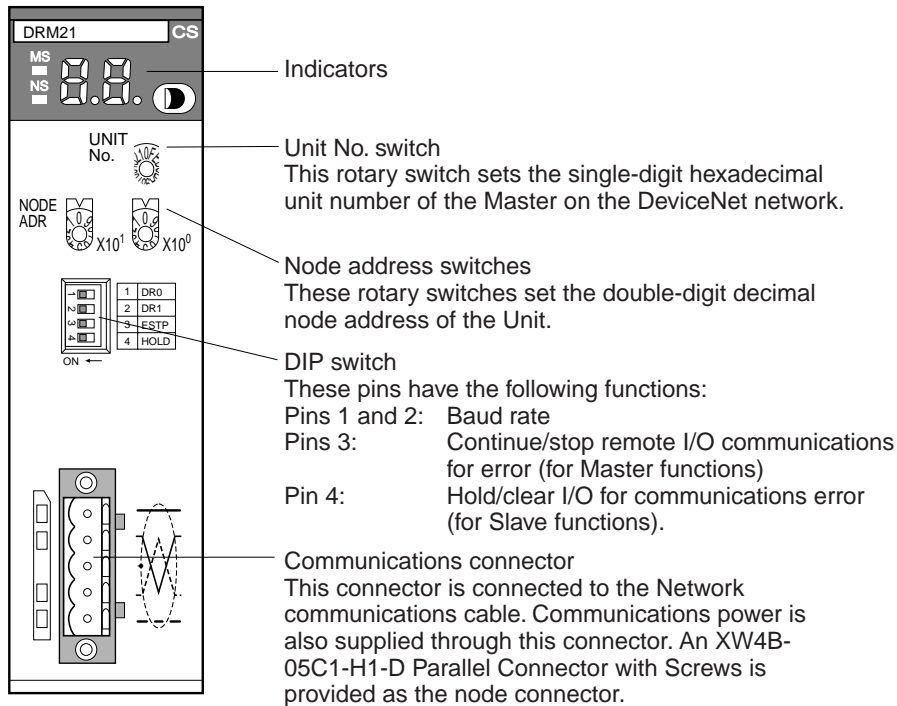

■ CJ1W-DRM21

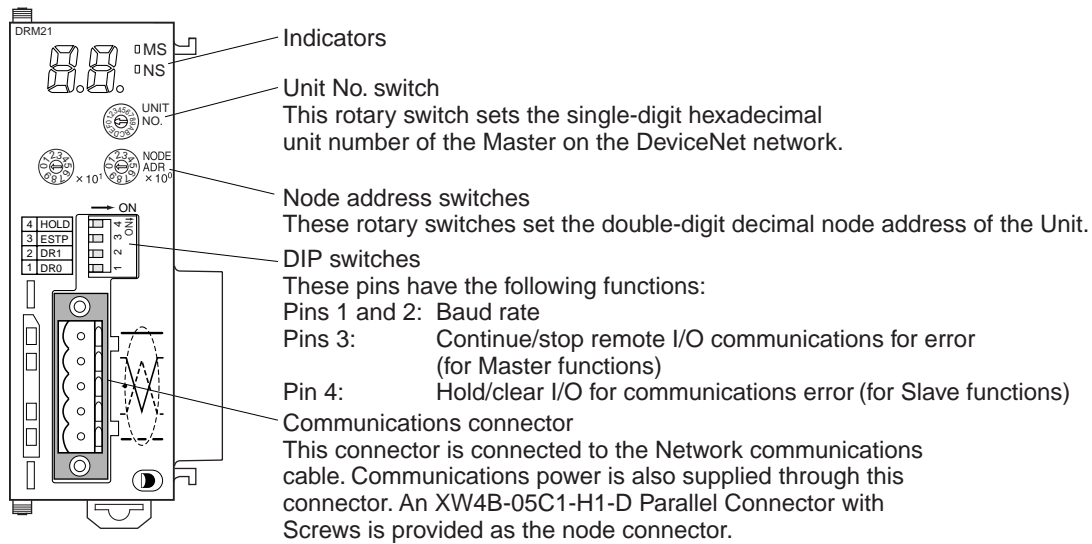

■ Mounting

- The CS-series DeviceNet (Master) Unit is mounted to the Backplane of the PLC in the same way as other Units are normally mounted.
- CJ-series DeviceNet (Master) Units need no Backplane, so connect the Units together by joining the connectors. For details on mounting DeviceNet (Master) Units to PLCs, and PLCs to control panels, refer to the applicable PLC Operation Manual.

2-3-2 Mounting and Setting Slaves

■ Settings

The following example shows Slave settings. For details on how to set Slaves, refer to the explanation in the Slave's operation manual.

- DRT2-ID16 Remote I/O Terminals (transistor inputs)
Node address: 01
- DRT2-OD16 Remote I/O Terminals (transistor outputs)
Node address: 02
- 3G3MV-A2001 SYSDRIVE Inverter
3G3MV-PDRT2 DeviceNet Communications Unit
Node address: 03
- DRT2-OD16 Remote I/O Terminals (transistor outputs)
XWT-OD08 Remote I/O Terminal Expansion Unit
Node address: 05

■ Mounting

Refer to the Inverter's operation manual for details on mounting the Inverter.

2-3-3 Mounting Connecting Devices

The following connecting devices require being mounted:

- T-branch Taps: Secure to the control panel with screws, or mount to a DIN track.
- Terminal-block Terminating Resistors: Secure to the control panel with screws.

2-3-4 Connecting Cables

■ Connecting Communications Cables

Connect the DeviceNet (Master) Unit and T-branch Taps, T-branch Taps and T-branch Taps, and T-branch Taps and Slaves using Thin DeviceNet Communications Cables, as shown in the following diagram.

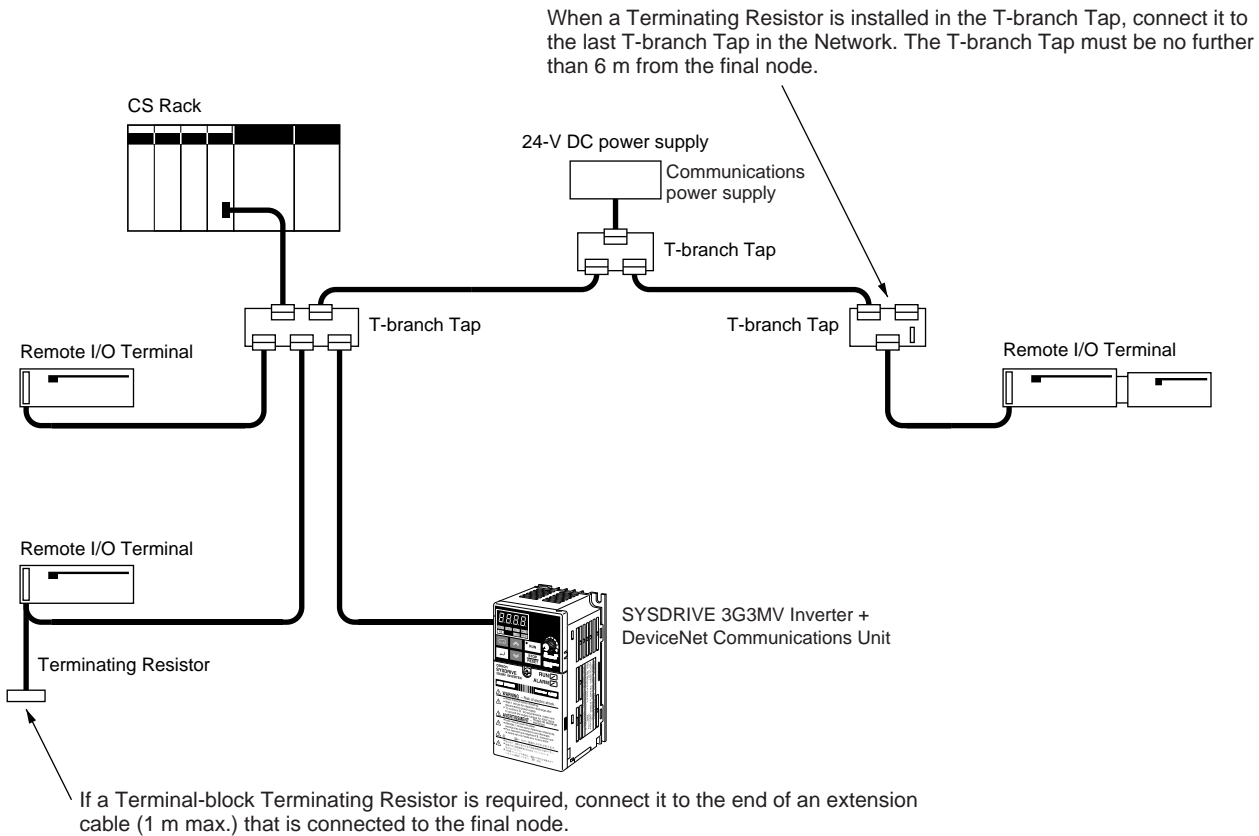

Use the following procedure to connect the cables. Refer to the *DRT2 DeviceNet Slaves Operation Manual (W404)* for details.

1. Prepare the communications cables and attach the connectors to the cables.
2. Connect the communications cable connectors to the node connectors on the DeviceNet (Master) Unit, T-branch Taps, and Slaves.

■ Wiring the Remote I/O Terminal

Connect the I/O power supply for I/O devices and the I/O signal lines to the Remote I/O Terminals. Attach M3 crimp terminals to the power lines and I/O signal lines and then connect them to the terminal block.

■ Wiring the Inverter

Connect the power supply (200 VAC) to the Inverter.

When required, connect an I/O power supply for I/O devices and the I/O signal lines to the Inverter.

Note Refer to the Inverter's operation manual for details on wiring the terminal block.

2-4 Starting Communications

After setting and wiring the hardware, turn ON the communications power supply, the internal power supply of each node, and the I/O power supply, and then start communications using the following procedure.

2-4-1 Creating I/O Tables for the DeviceNet (Master) Unit

I/O tables must be created in the CPU Unit to distinguish between the different Slaves mounted to the PLC. Turn ON the PLC to which the DeviceNet (Master) Unit is mounted, connect the Peripheral Devices to the PLC, and create the I/O tables. After the I/O tables have been created, turn OFF the power to the PLC.

The following example shows the procedure for creating I/O tables using a Programming Console. For details on creating I/O tables, refer to the operation manual for the Peripheral Device being used.

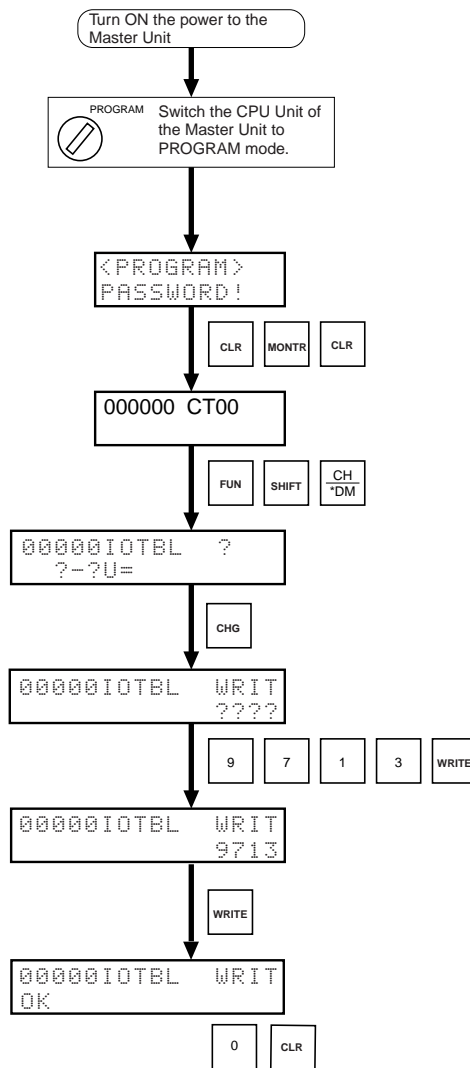

2-4-2 Starting the System

Turn ON the communications power supply and the power to other nodes in the following order.

1. Turn ON the communications power supply.
2. Turn ON the power to each Slave.
3. Turn ON the power to the DeviceNet (Master) Unit.

Note The power supplies listed above can all be turned ON simultaneously. The external I/O power supply can be turned ON at any time.

2-4-3 Creating and Registering Scan Lists

Scan lists are lists that register the information that is transferred between DeviceNet (Master) Units and Slaves. The DeviceNet (Master) Unit compares the scan list with the status of the Slave currently being communicated with, so communications with the Slave are always being checked.

For details on scan lists and remote I/O communications, refer to the operation manual for the DeviceNet (Master) Unit.

Note When a scan list is disabled, communications are possible with all Slaves on the DeviceNet Network with fixed allocations. Without scan lists, however, the DeviceNet (Master) Unit cannot check if there is an error in a Slave.
For normal operations, always enable the scan lists.

■ Precautions

● User I/O Allocations

The user can allocate any words for Slave I/O for the DeviceNet I/O Areas (IN Area, OUT Area) in the DeviceNet (Master) Unit.

When user allocations are used, scan lists must be created with a DeviceNet Configurator and registered in the DeviceNet (Master) Unit. The scan list is enabled as soon as it is registered, and remote I/O communications start according to the scan list.

For details, refer to the DeviceNet Operation Manual (W267) and the DeviceNet Configurator Operation Manual (W382).

● Fixed I/O Allocations

Slave I/O is allocated in the DeviceNet I/O area (IN Area, OUT Area) in the DeviceNet (Master) Unit in the same order as the Slave node addresses.

When fixed allocations are used, the scan lists are automatically created and registered using the DeviceNet (Master) Unit's software switches. The scan list is enabled as soon as it is registered, and remote I/O communications start according to the scan list. When scan list is enabled, the mode is called the scan list-enabled mode.

The registered scan lists can be cleared using the software switches. When scan lists are cleared (disabled), the mode is called the scan list-disabled mode.

■ Creating and Registering Fixed Allocation Scan Lists

The method of creating and registering scan lists for fixed allocation using Programming Console and a CS/CJ-series DeviceNet (Master) Unit is explained here. For details on operating Peripheral Devices, refer to the operation manual for the Peripheral Device being used with the PLC. For details on creating scan lists, refer to the operation manual for the DeviceNet (Master) Unit.

● Creating and Registering Scan Lists

Use the following procedure to create, register, and enable the scan lists.

In the following example, $n = 1500 + (25 \times \text{unit number})$.

Clearing and Creating Scan Lists

Switch the operating mode switch to PROGRAM mode.

Enable the DeviceNet (Master) Unit functions. Set the DeviceNet (Master) Unit function enable switch (bit 06 of word n) from OFF to ON.

Clear the scan lists. Set the scan list clear switch (bit 01 of word n) from OFF to ON.

Select the fixed allocation areas 1 to 3. Set the DeviceNet (Master) Unit's setting switch for fixed allocation areas 1 to 3 (bit 00 of word n) from OFF to ON.

Enable the scan lists. Set the scan list enable switch (bit 00 of word n) from OFF to ON.

Switch the operating mode switch to RUN or MONITOR mode.

Checking the Normal Slave Table

Monitor the normal Slave table (words $n+20$ to $n+23$) and confirm that the corresponding bits are ON.

In the normal Slave table, the corresponding bits will be ON for the nodes that are communicating properly.

Note With this Chapter's example system configuration, a value of 002E in word $n+20$ indicates normal operation.

2-5 Checking Operation

Use the procedures provided here to check that I/O communications are operating normally.

2-5-1 Indicator Status

I/O communications are operating normally if the MS and NS indicators for all nodes are lit green, and the 7-segment indicator on the front panel of the DeviceNet (Master) Unit is displaying the node address of the DeviceNet (Master) Unit as shown in the following diagram, and the scan list is enabled. The following example shows a node address of 63 for the DeviceNet (Master) Unit.

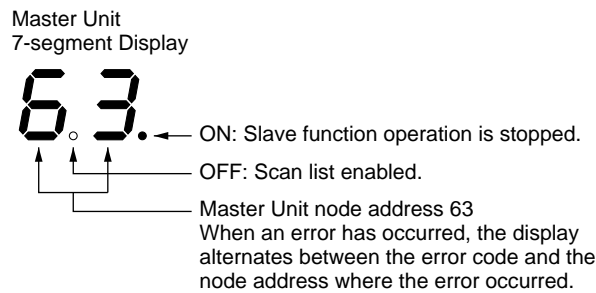

2-5-2 Reading and Writing Data

Connect the Peripheral Device for the PLC to the DeviceNet (Master) Unit, write the DeviceNet (Master) Unit's OUT Area and read the IN Area, and check that the data are the same in the Slaves.

Refer to the operation manual for the DeviceNet (Master) Unit for details on OUT Area and IN Area addresses and how to allocate Slave I/O.

■ I/O between Remote I/O Terminals

Create ladder programs in the PLC of the DeviceNet (Master) Unit, and check that when the switch on the DRT2-ID16 Input Terminal turns ON, the indicator on the DRT2-OD16 Output Terminal is ON.

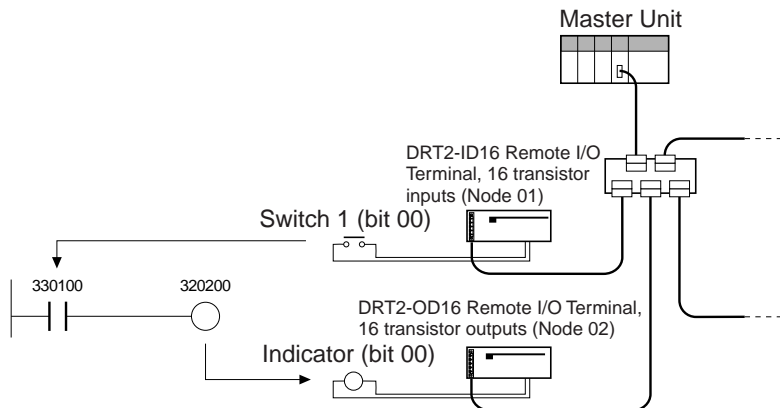

■ Example IN Area and OUT Area

The following diagram shows the IN and OUT Area allocations for this Chapter’s example system configuration when fixed I/O allocation is used for remote I/O communications.

Word	OUT Area	Word	IN Area	Fixed allocation
3200	Not used	3300	Not used	(Node 0)
3201	Not used	3301	DRT2-ID16 (node 1)	Node 1
3202	DRT2-OD16 (node 2)	3302	Not used	Node 2
3203	3G3MV-PDRT2	3303	3G3MV-PDRT2	Node 3
3204	(node 3)	3304	(node 3)	(Node 4)
3205	DRT2-OD16 (node 5)	3304	Not used	Node 5
3206	Not used XWT-OD08	3304	Not used	(Node 6)
3207	Not used	3304	Not used	(Node 7)
3208	Not used	3304	Not used	(Node 8)
3209	Not used	3304	Not used	(Node 9)

When shipped, the Inverter’s default communications setting is “Standard Remote I/O”, so the following functions are allocated to the node 3 Inverter.

● Outputs (PLC to Inverter)

Byte number			Bit 7	Bit 6	Bit 5	Bit 4	Bit 3	Bit 2	Bit 1	Bit 0
Wd 3203	Right-most	0		Net Reference	Net Control			Fault Reset	Reverse/stop	Forward/stop
	Left-most	1								
Wd 3204	Right-most	2	Rotational speed reference (rightmost data)							
	Left-most	3	Rotational speed reference (leftmost data)							

● Inputs (Inverter to PLC)

Byte number			Bit 7	Bit 6	Bit 5	Bit 4	Bit 3	Bit 2	Bit 1	Bit 0
Wd 3303	Right-most	0	At Reference	Reference From Net	Control From Net	Inverter Ready	During reverse run	During forward run	Alarm (minor fault)	Fault
	Left-most	1								
Wd 3304	Right-most	2	Rotational speed monitor (rightmost data)							
	Left-most	3	Rotational speed monitor (leftmost data)							

Note A shaded box indicates that the bit is not used.

■ Verification Procedure

Use the following procedure to operate the Inverter and verify proper operation.

The operational check is performed with the Inverter’s forward reference. Thoroughly confirm the safety of the equipment before operating the system.

Note Refer to the preceding page for details on the contents of each word.

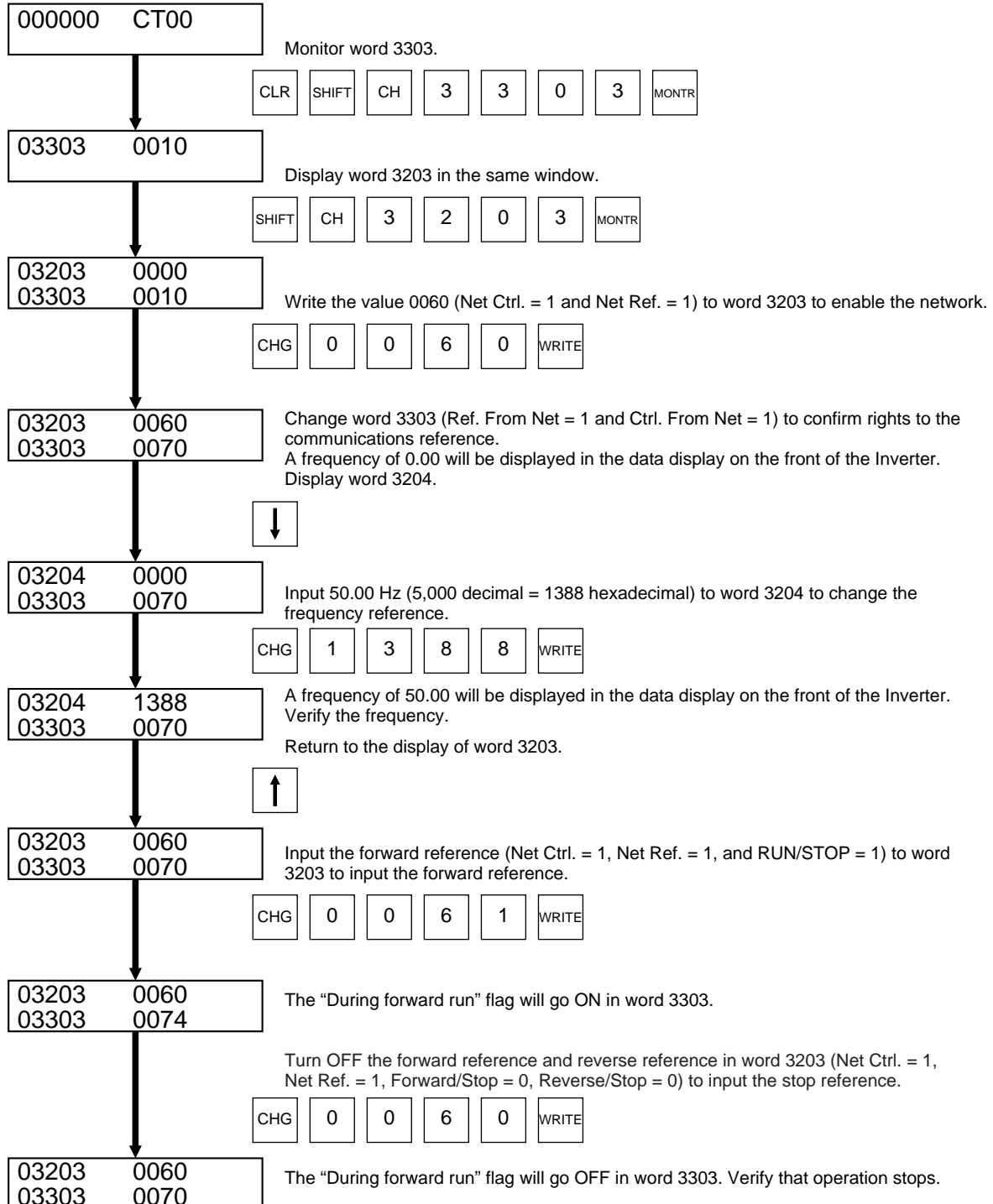

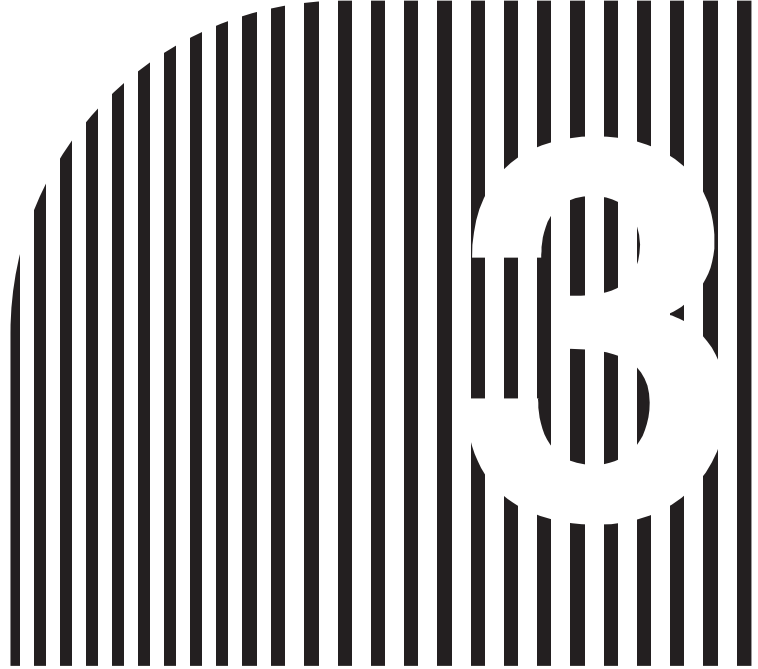

Chapter 3

Setup and Wiring

- 3-1 Nomenclature and Settings
- 3-2 Installation and Wiring
- 3-3 Communications Line Noise Prevention
- 3-4 Conformity to EC Directives

3-1 Nomenclature and Settings

3-1-1 Names of Parts

- 3G3MV-PDRT2 DeviceNet Communications Unit

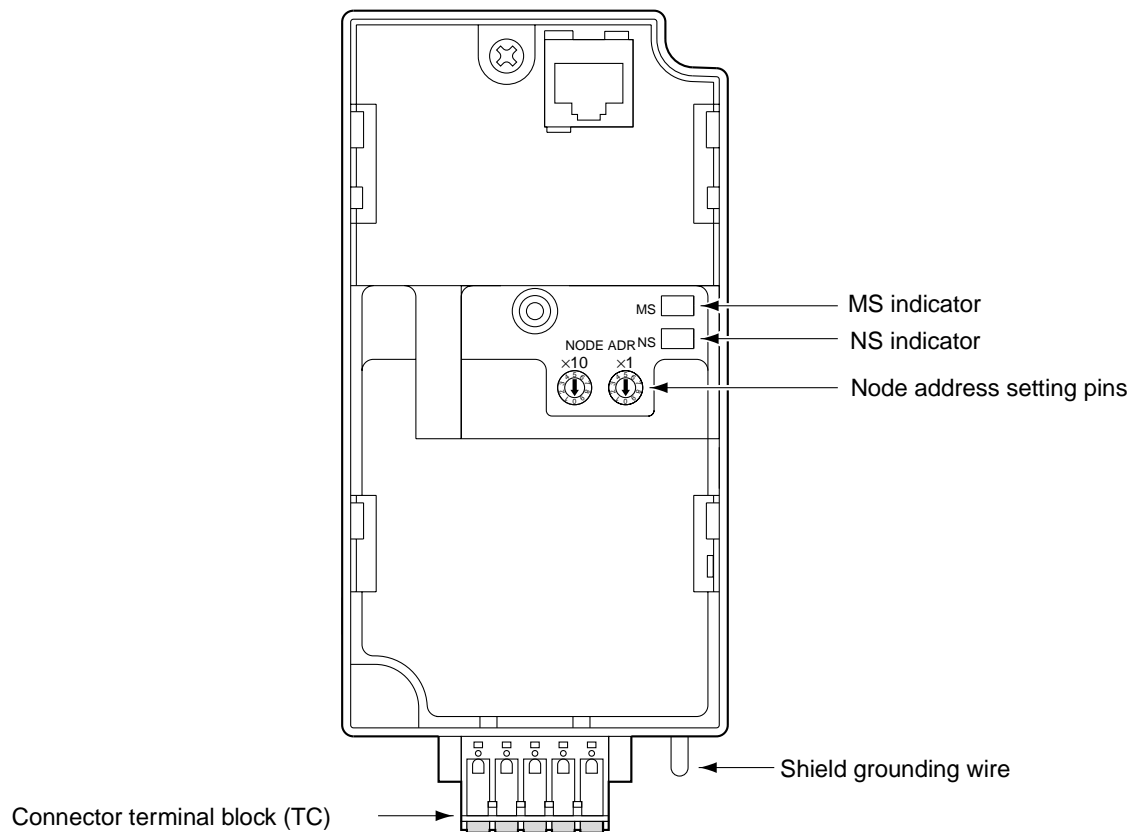

● 3G3RV-PDRT2 DeviceNet Communications Card

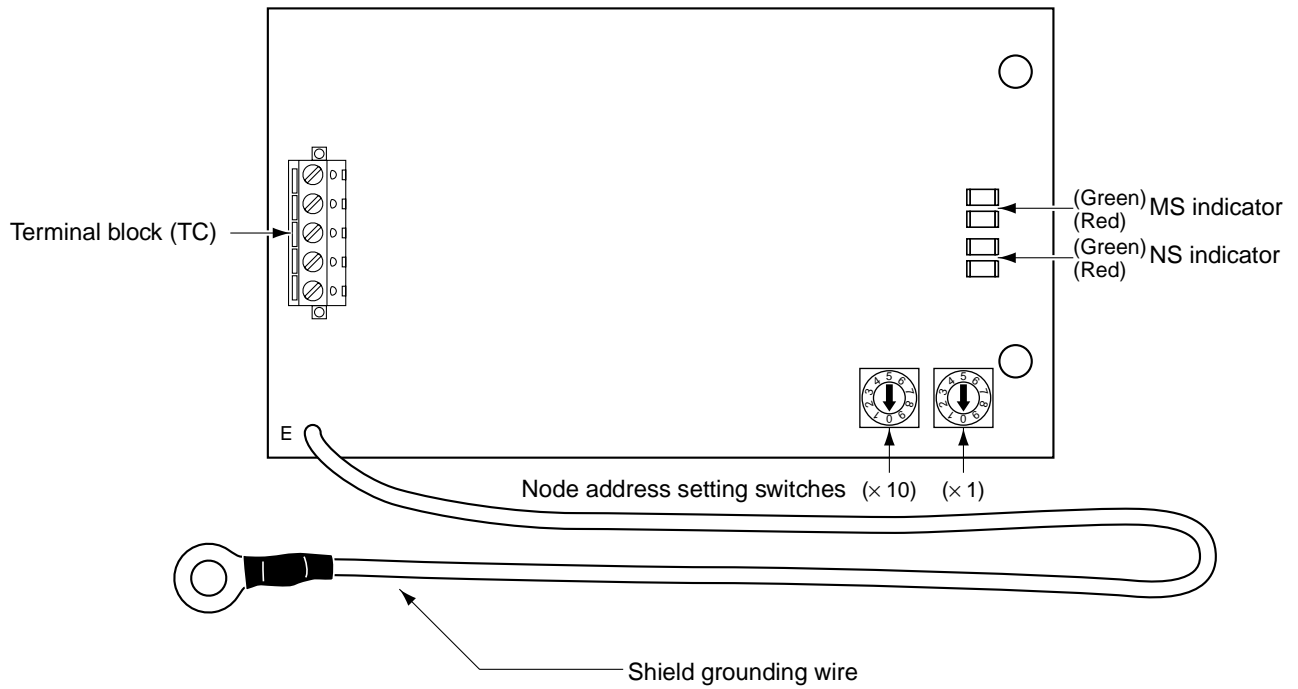

3-1-2 Terminal Block

The following table provides details of the terminal block, which connects to the communications line.

Sticker color	Code	Cable color	Details
Black	V-	Black	Communications power supply ground.
Blue	CAN L	Blue	Communications data low side.
---	SG	(Shield)	Shield connection.
White	CAN H	White	Communications data high side.
Red	V+	Red	Communications power supply, 24 V DC.

3G3MV-PDRT2 Terminal Block

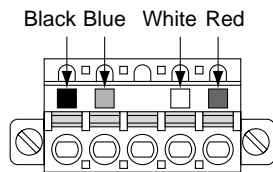

3G3RV-PDRT2 Terminal Block

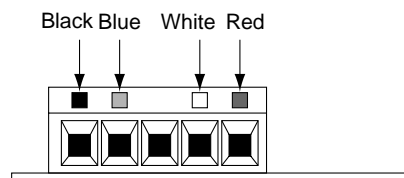

3-1-3 Operation Indicators

The DeviceNet Communications Unit/Card has 2 operation indicators that show the status of the power and communications as described in the following table.

Indicator	Display		Meaning
	Color	Status	
MS	Green	Lit	Power is being supplied and the Unit/Card is operating normally.
		Flashing	Initial settings or necessary preparations for communications are incomplete.
	Red	Lit	A fatal error (hardware error) has occurred in the Unit/Card.
		Flashing	A non-fatal error, such as a switch setting error, has occurred.
	---	Not lit	Power is not being supplied from the Inverter. The Unit/Card is not connected properly and power is not being supplied to it.
NS	Green	Lit	The DeviceNet Network is operating normally. (Online and communications connection established.)
		Flashing	The Network is normal, but the communications connection with the Master Unit is not established.
	Red	Lit	A fatal communications error has occurred. A DeviceNet communications error was detected caused by node address duplication or Bus OFF. (These errors make communications impossible.)
		Flashing	A non-fatal communications error has occurred due to communications timeout.
	---	Not lit	A DeviceNet Network error has occurred (offline). For example, the Network does not exist, power is not supplied to the Unit, or the baud rates do not match.

3-1-4 Node Address Settings

A unique number (called a node address) is assigned to each Master/Slave in order to manage communications in the network.

There are two ways to set the node addresses. The node addresses can be set with the rotary switches on the DeviceNet Communications Unit/Card or from the Configurator.

■ Setting the Node Address with the Rotary Switches

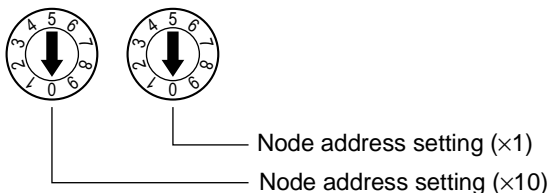

Set the 10s digit with the left switch and the 1s digit with the right switch (up to node address 63). When the node address is set to a value between 64 and 99, the node address can be set from the Configurator. (See Configurator setting procedure below.)

Note The Unit/Card reads the node address setting on the rotary switches when the power is turned ON.

■ Setting the Node Address from the Configurator

1. Double-click the icon of the corresponding Slave (Inverter) in the Network Configuration Window, or click the right mouse button over the icon and select **Change Node Address**.

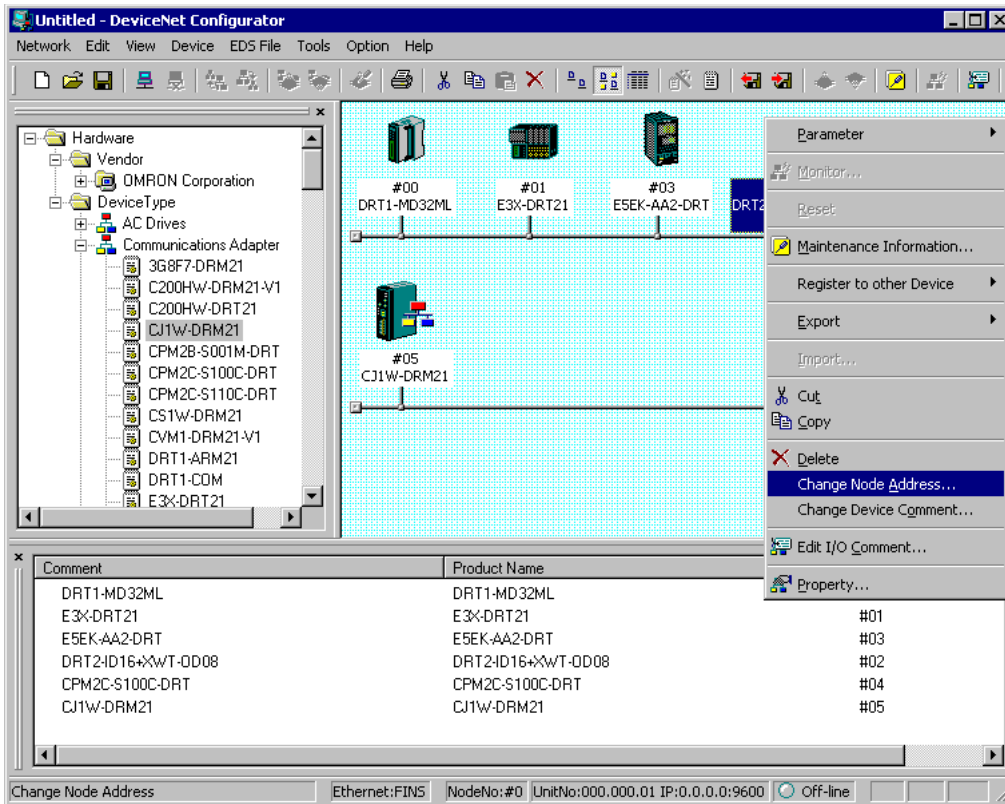



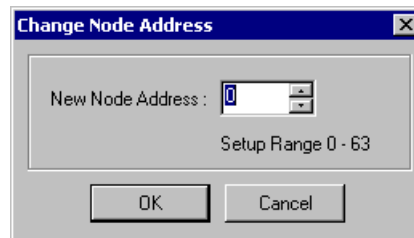





2. A Node Address Setting Window will be displayed. Input the desired node address.



3. Click the **OK** Button.

Note Any node address between 0 and 63 can be set as long as it is not duplicated in another Master or Slave in the network. If the node address is duplicated in another node in the network, an error will occur and the Slave will not be able to participate in network communications.

3-2 Installation and Wiring

-  **WARNING** Do not touch the conductive parts such as internal PCBs or terminal blocks while power is being supplied. Doing so may result in electrical shock.
-  **WARNING** Turn ON the input power supply only after mounting the front cover, terminal covers, bottom cover, Operator, and optional items. Leave them mounted in place while power is being supplied. Not doing so may result in electrical shock, malfunction, or damage to the product.
-  **WARNING** Wiring, maintenance, or inspection must be performed by authorized personnel. Not doing so may result in electrical shock or fire.
-  **WARNING** Wiring, maintenance, or inspection must be performed after turning OFF the power supply, confirming that the CHARGE indicator (or status indicators) is OFF, and after waiting for the time specified on the Inverter front cover. Not doing so may result in electrical shock.
-  **WARNING** Do not damage, pull on, apply stress to, place heavy objects on, or pinch the cables. Doing so may result in electrical shock, operation stoppage, or burning.
-  **WARNING** Install devices to stop operation as required to ensure safety. Equipment damage may result. This is particularly important when operation is set to continue for communications errors because the Inverter will continue operation.
-  **WARNING** Do not attempt to disassemble or repair the Unit. Doing either of these may result in electrical shock, injury, or damage to the product.
-  **Caution** Do not store, install, or operate the product in the following places. Doing so may result in electrical shock, fire or damage to the product.
- Locations subject to direct sunlight.
 - Locations subject to temperatures or humidity outside the range specified in the specifications.
 - Locations subject to condensation as the result of severe changes in temperature.
 - Locations subject to corrosive or flammable gases.
 - Locations subject to exposure to combustibles.
 - Locations subject to dust (especially iron dust) or salts.
 - Locations subject to exposure to water, oil, or chemicals.
 - Locations subject to shock or vibration.
-  **Caution** Do not allow foreign objects to enter inside the product. Doing so may result in fire or malfunction.

- ⚠ **Caution** Do not apply any strong impact. Doing so may result in damage to the product or malfunction.
- ⚠ **Caution** Be sure to wire correctly and securely. Not doing so may result in injury or damage to the product.
- ⚠ **Caution** Be sure to firmly tighten the screws on the terminal block. Not doing so may result in fire, injury, or damage to the product.
- ⚠ **Caution** Carefully handle the product because it uses semiconductor elements. Careless handling may result in malfunction.
- ⚠ **Caution** Take appropriate and sufficient countermeasures when installing systems in the following locations. Not doing so may result in equipment damage.
 - Locations subject to static electricity or other forms of noise.
 - Locations subject to strong electromagnetic fields and magnetic fields.
 - Locations subject to possible exposure to radioactivity.
 - Locations close to power supplies.

3-2-1 3G3MV DeviceNet Communications Unit Installation

- ⚠ **Caution** Before installing and wiring an Optional Unit, always turn OFF the power to the SYSDRIVE 3G3MV Inverter and wait for the CHARGE indicator to turn OFF.

■ Mounting Procedure

1. Turn OFF the main circuit power supply for the Inverter, wait for at least one minute from the time the LED indicator or the CHARGE indicator goes out, and remove the front cover of the Inverter along with the Operator.

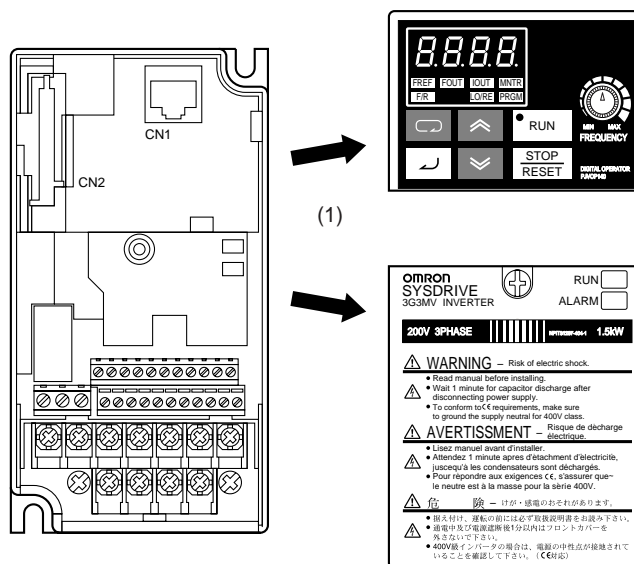

2. Wire the main circuit terminals and control circuit terminals of the Inverter. (When the Communications Unit is mounted, the terminal block of the Inverter will be covered. Therefore, be sure to complete wiring for the Inverter terminals first.)
3. When the Operator of the Inverter is removed, it will be possible to see a block secured at three places underneath. Using pliers or another appropriate tool, loosen the fixings, and remove the block. The connector for Optional Unit connections will become visible. At this point, ensure that dirt or foreign objects do not enter the connector.

(3) Using pliers, cut sections indicated with "X."

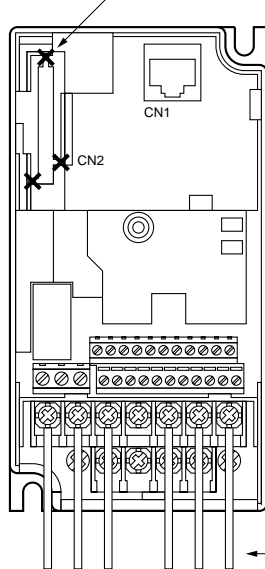

(2) Wire the main circuit terminals and control circuit terminals.

4. Mount the mounting base (included as an accessory) onto the screw-holes originally used for holding the Operator and the terminal cover to the body of the Inverter, and using the screws provided as accessories, secure the mounting base.

(4) Mounting base

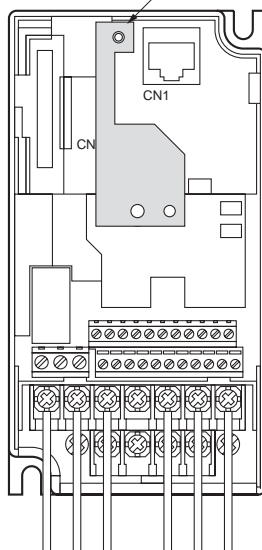

5. On the opposite side of the DeviceNet Communications Unit, there is a ground terminal that connects to the shield wire for the Communications Cable. Connect this ground terminal to the FG terminal of the Inverter.

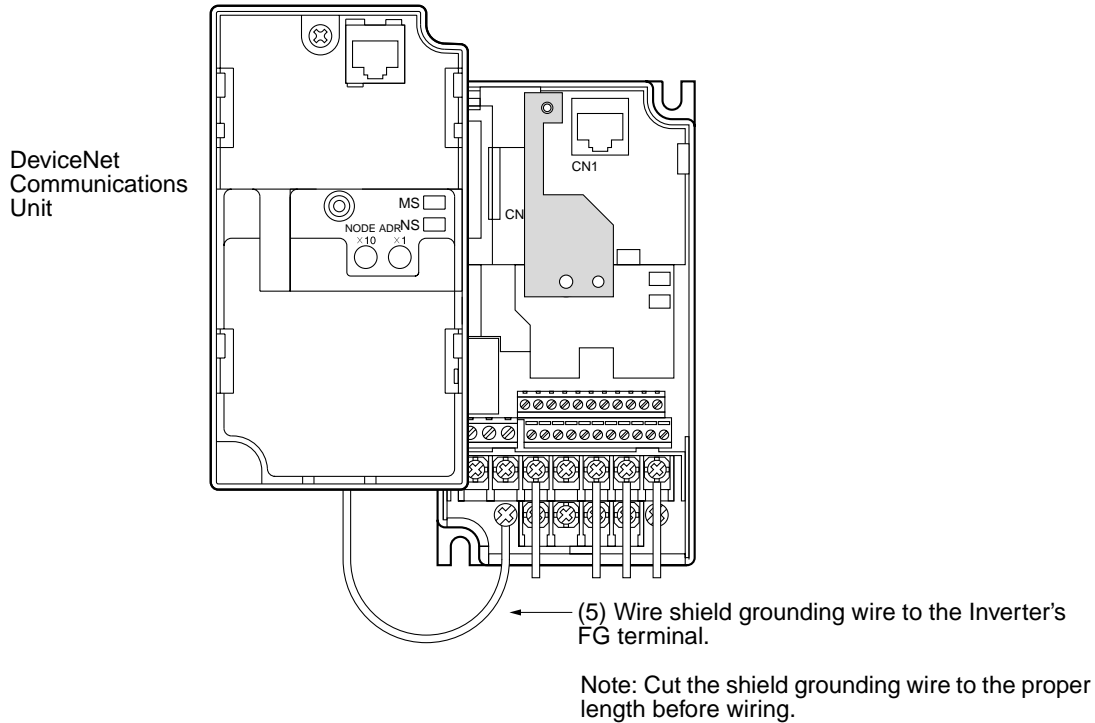

6. After aligning the positions of the DeviceNet Communications Unit connector and the Inverter connector, push the frames of the Inverter and the Unit together until they click.
7. Tighten the fixing screws on the upper part of the DeviceNet Communications Unit, to the mounting base attached in step 4.
8. Wire the communications cables, and set the Unit's node address.
9. Attach the Operator and the terminal cover to the front side of the DeviceNet Communications Unit, and secure them by tightening the screw in the center.
10. Attach the MS and NS stickers (on the provided sheet of DeviceNet indicators labels) over the RUN and ALARM labels on the front cover. (The LED indicator functions have changed from RUN to MS and from ALARM to NS.)

■ Connecting Communications Cables

This section explains how to prepare and connect the communications cables to connectors for the DeviceNet Network.

Use the following procedure to prepare and connect the communications cables to the connectors.

Note For connecting of the DeviceNet Communications Unit of the Inverter, use DCA1-5C10 Thin Cables.

Thick Cables cannot be used for this kind of wiring because of the terminal block dimensions.

1. Remove about 30 mm of the cable covering, being careful not to damage the shield weaving underneath. Do not remove more than about 30 mm; removing too much of the covering can result in short circuits.

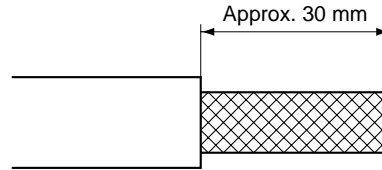

2. Carefully peel back the weaving to reveal the signal lines, power lines, and the shielding wire. The shielding wire will be loose on the outside of the other lines, but it is harder than the weaving.

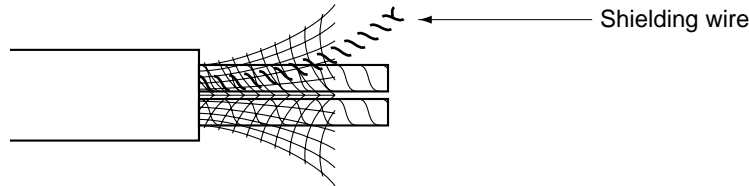

3. Remove the exposed weaving and the aluminum tape from the signal and power lines. Strip the covering from the signal and power lines to the proper length for the crimp terminals. Twist together the wires of each of the signal and power lines.

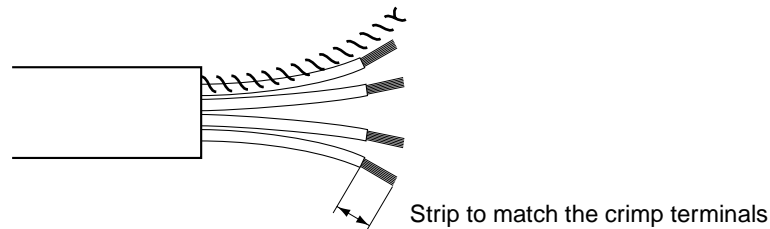

4. Attach the solderless crimp terminals to the stripped wire ends and apply electrical tape or heat-shrink tubing to the terminal shaft.

Verify that the each wire is being connected to the correct contact and insert the signal lines, power lines, and shield wire into the connector holes. The following diagram shows the proper order of insertion (red, white, shield, blue, and black, top to bottom).

In connectors without set screws, it isn't necessary to tighten set screws as it was in earlier models. Press the orange button while inserting each wire fully into the connector. After inserting the wire, release the orange button and pull lightly on each wire to verify that it is properly installed in the connector.

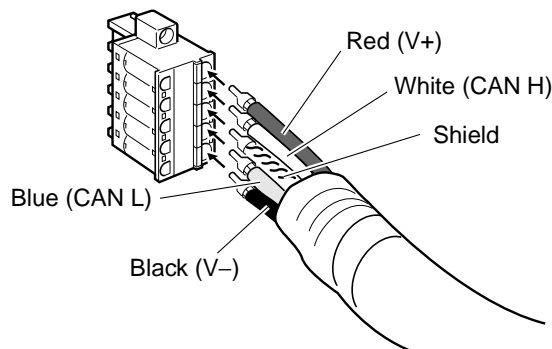

The Master and Slave Unit connectors have colored stickers that correspond to the wire colors. When wiring, the sticker color and wire color can be compared to verify that the wiring is correct. The following table shows the cable colors.

Sticker color	Code	Cable color	Details
Black	V-	Black	Communications power supply ground.
Blue	CAN L	Blue	Communications data low side.
---	SG	(Shield)	Shield connection.
White	CAN H	White	Communications data high side.
Red	V+	Red	Communications power supply, 24 V DC.

■ Wiring the Inverter

● 3G3MV Series

When the DeviceNet Communications Unit is installed, the Inverter's main circuit and control circuit terminals will be inaccessible, so always wire the main circuit terminals and control circuit terminals in advance according to the directions in the User's Manual.

3-2-2 DeviceNet Communications Card Installation



Caution

Before installing and wiring an Optional Card, always turn OFF the power to the SYSDRIVE 3G3RV/3G3PV/3G3FV Inverter and wait for the CHARGE indicator to turn OFF.

■ Mounting Procedure

1. Turn OFF the Inverter, wait for at least 5 minutes, remove the front cover of the Inverter, and check that the CHARGE indicator is not lit.
2. Mount the Optional Card to the option C area.
3. The 3G3RV and 3G3PV has a securing latch for option C and option D, so the securing latch must be removed.
4. Insert the provided spacers into the spacer holes on the mounting base of the Inverter.
5. After properly engaging the connectors of the Optional Card and control circuit board, insert the spacers to the spacer holes of the Optional Card, and press the Optional Card until the spacers click.
6. If a 3G3RV or 3G3PV is being used, replace the securing latch that was removed in step 3.
7. Connect the shield grounding wire of the Optional Card to FG terminal 12 (E) on the control circuit board of the Inverter.
8. Press the top of the connector 2CN and check that the apexes of the triangular marks on both sides match.

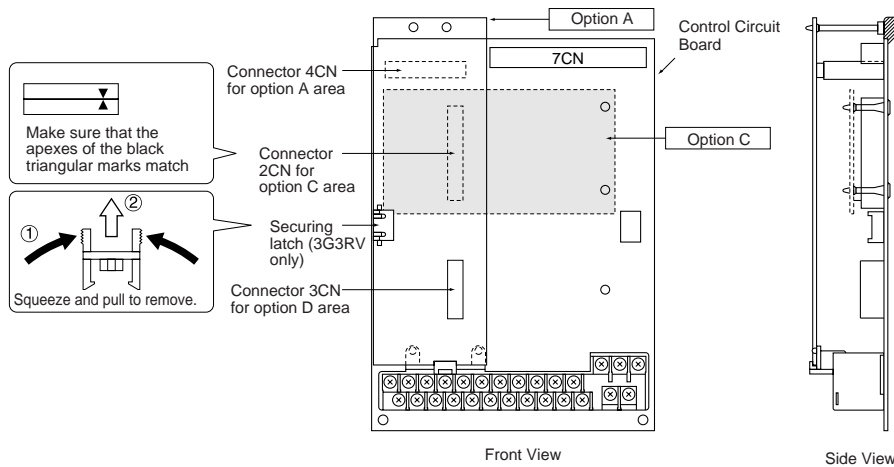

Note When the DeviceNet Communications Card is mounted, other Optional Cards cannot be mounted in the C area.

■ Communications Cable Wiring

This section explains how to prepare and connect the communications cables to connectors for the DeviceNet Network.

Use the following procedure to prepare and connect the communications cables to the connectors.

Note For connecting of the DeviceNet Communications Card of the Inverter, use DCA1-5C10 Thin Cables.

Thick Cables cannot be used for this kind of wiring because of the terminal block dimensions.

1. Remove about 30 mm of the cable covering, being careful not to damage the shield weaving underneath. Do not remove more than about 30 mm; removing too much of the covering can result in short circuits.

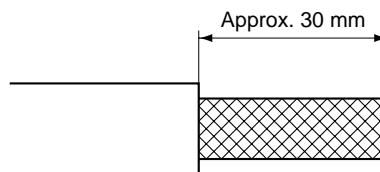

2. Carefully peel back the weaving to reveal the signal lines, power lines, and the shielding wire. The shielding wire will be loose on the outside of the other lines, but it is harder than the weaving.

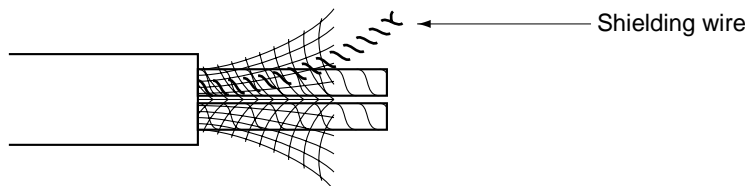

3. Remove the exposed weaving and the aluminum tape from the signal and power lines. Strip the covering from the signal and power lines to the proper length for the crimp terminals. Twist together the wires of each of the signal and power lines.

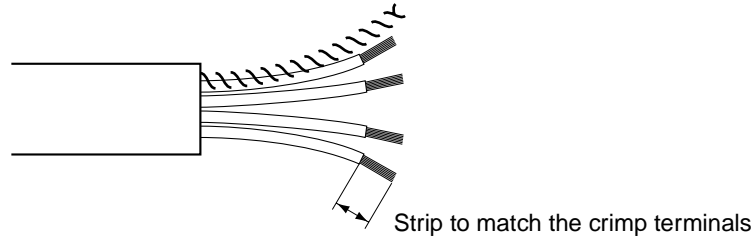

■ DeviceNet Communications Card Terminal Block Wiring Procedure

1. Loosen the terminal screws using a thin flat-blade screwdriver.
2. Insert the wires from underneath the terminal block.
3. Tighten the terminal screws securely to a torque of 0.5 to 0.6 N·m.

Note 1. Separate the DeviceNet communications cables from the main circuit wiring and other power lines.

Note 2. Do not solder the ends of the electric wires. Doing so may cause contact failure.

Note 3. If straight crimp terminals are not used, strip the electrical wires to a length of 5.5 mm.

Note 4. Do not tighten the screws with a torque exceeding 0.6 N·m. Doing so may damage the terminal block. If the screws are too loose, however, malfunctions or short circuits may result.

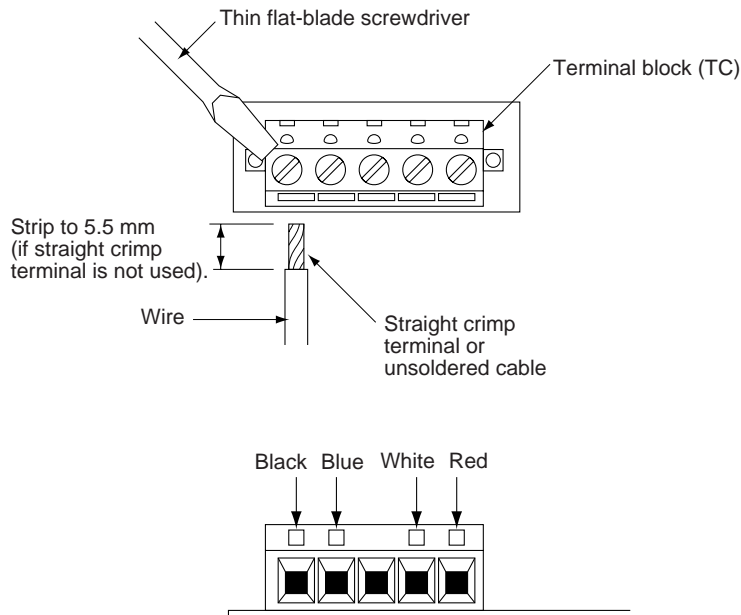

■ Inverter Wiring

● 3G3RV/3G3PV/3G3FV Series

Keep the DeviceNet wiring separated from the main circuit wiring as much as possible. Do not wire them together.

3G3RV/3G3PV Inverters of 5.5 kW or Less

3G3FV Inverters of 15 kW or Less

Remove the plastic knockout on the side of the Inverter. Remove the knockout with snips and wire through this side hole.

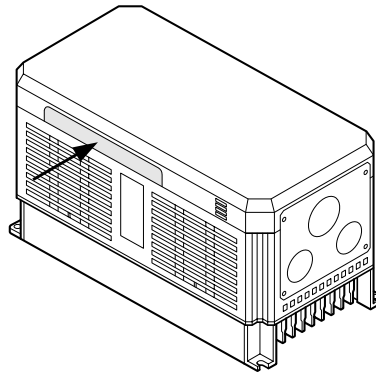

3G3RV/3G3PV Inverters of 7.5 kW or More

3G3FV Inverters of 18.5 kW or More

- Route the DeviceNet communications line along the left side of the DeviceNet Communications Card and wire it to the Card.
- Do not bundle the control wiring and main circuit wiring together.

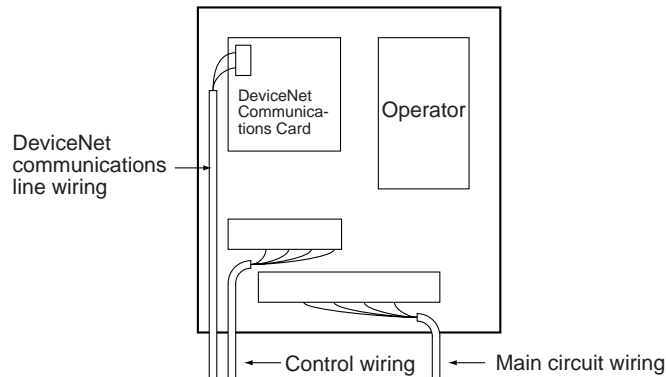

3-2-3 Connecting Communications Cables to T-branch Taps

To allow for easier maintenance, use a T-branch Tap or T-branch wiring to connect the DeviceNet Communications Unit. This section shows how to connect a communications cable with a connector attached to a T-branch Tap.

There are two kinds of T-branch Taps, one makes a single branch and the other makes three branches, but the cable connections are the same for both. The connectors indicated by asterisks in the following diagrams have the least resistance and these connectors should be used for the trunk line connections. When using a T-branch Tap on a drop line, connect the longest drop line to these connectors.

● DCN1-1C T-branch Tap

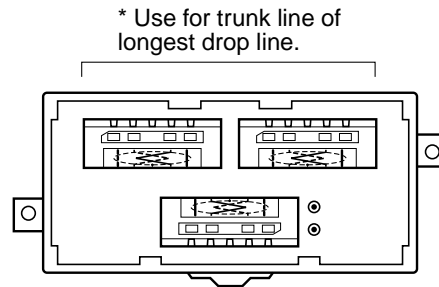

● DCN1-3C T-branch Tap

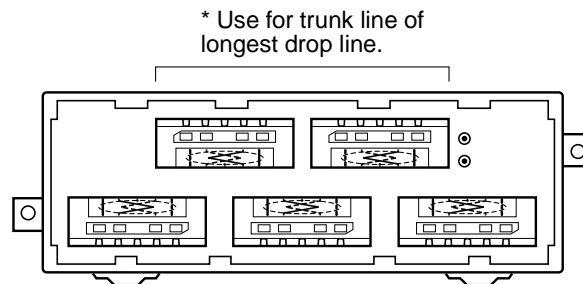

● T-branch Tap Connectors

The required number of connectors (on cable side) for T-branch Taps are supplied with the product.

Name	Plug with Screw Flange
Model	XW4B-05C1-H1-D
Manufacturer	OMRON
Specifications	One per terminal opening, with set screws

Align the cable connector with the socket on the T-branch Tap as shown in the following diagram and fully insert the connector into the socket. Tighten the set screws to secure the connection. Tighten the screws to a torque of 0.3 N·m.

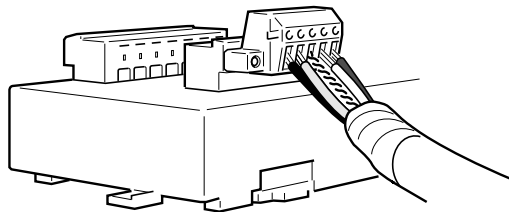

Note To avoid damaging the cable or breaking wires, do not pull on the cable or bend it too sharply when connecting it to the T-branch Tap. Also, never place heavy objects on top of the cable.

3-2-4 Connecting Terminating Resistors

Terminating resistors must be connected at each end of the trunk line. Use the methods described here to connect the Terminating Resistors.

● T-branch Tap Terminating Resistor

A Terminating Resistor is included with the T-branch Tap. Insert the Terminating Resistor into the T-branch Tap as shown in the following diagram. The Terminating Resistor can face in either direction.

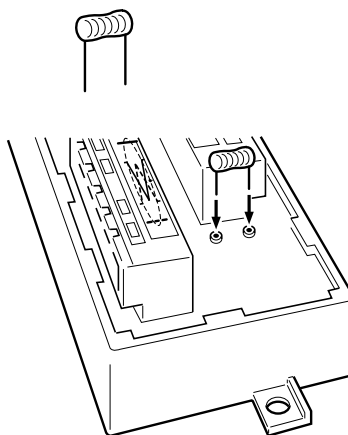

● Terminal-block Terminating Resistor

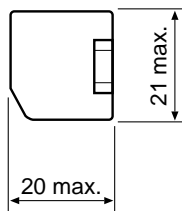
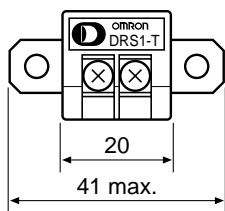

Model	DRS1-T
Specifications	121 Ω±1%, 1/4W
Manufacturer	OMRON

A Terminating Resistor is built into the Terminal-block Terminating Resistor. To connect the cable to the Terminating Resistor, attach standard M3 crimp terminals to the signal wires and securely screw the terminals to the Terminal-block Terminating Resistor. Tighten to a torque of 0.5 N·m.



Note To avoid damaging the cable or breaking wires, do not pull on the cable or bend it too sharply when connecting it to the terminal block. Also, never place heavy objects on top of the cable.

3-2-5 Making Multi-drop Connections

■ Using the Connector Provided with Unit (with Thin Cable)

When connecting thin cable with the multi-drop method, it is possible to insert two wires with the same color into the same hole as shown in the following diagram.

Example: Connector without Set Screws

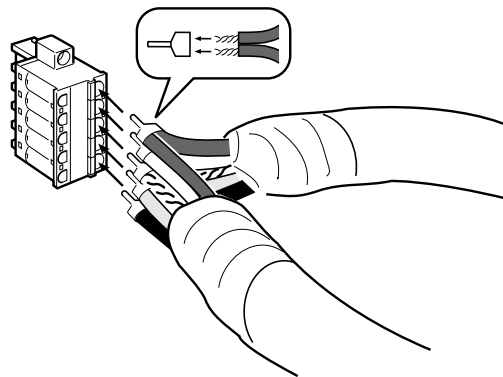

Insert the two wires into the same crimp terminal, as shown below.

Inserting two power supply wires

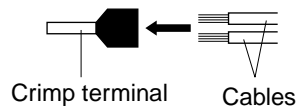

We recommend the following Phoenix Contact crimp terminals and crimping tool.

Crimp terminal	Crimping Tool
Model: AI-TWIN2×0.5-8WH (part number 3200933)	Model: UD06 (part number 1204436)

■ Thick Cables and Multi-drop Connections Using Multi-branch Parallel Connectors

Multi-drop connections are possible when using 3G3MV-PDRT2 with an Inverter (except 5.5-kW or 7.5-kW models), by using the following connectors.

XW4G-05C4-TF-D

XW4B-05C4-TF-D

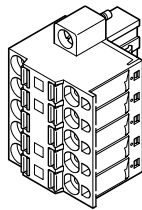

(Without set screws)

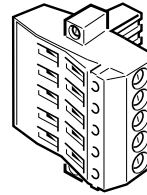

(With set screws)

Note These connectors cannot be used with the following models. Use the T-branch Connectors shown in *3-2-3 Connecting Communications Cables to T-branch Taps* instead.

- 3G3MV Series (5.5-kW and 7.5-kW models)
- 3G3RV Series
- 3G3FV Series

3-2-6 Supplying Communications Power through T-branch Tap

When supplying the communications power supply through a T-branch Tap, attach the power supply cables V+ and V- lines just like the communications lines. When there is a communications power supply at just one point, connect the shield wire and ground line (100 Ω max.) at the same time as shown in the following diagram.

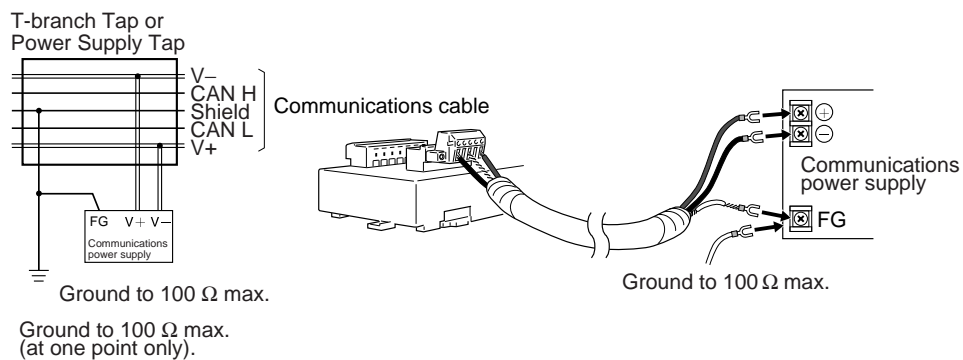

3-2-7 Recommended Products

● Recommended Crimp Terminals

We recommend the following crimp terminals.

Phoenix Contact AI Series AI-0.5-8WH-B (part number 3201369)

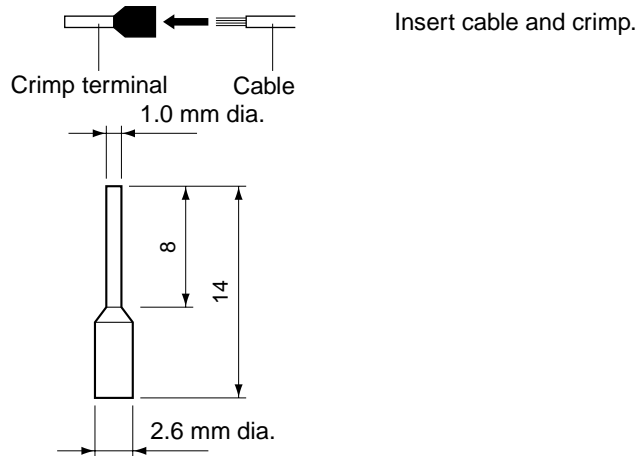

We recommend the following crimp tool: Phoenix Contact ZA3

● Screwdriver for Set Screws

We recommend the following screwdriver for connectors with set screws: OMRON XW4Z-00C

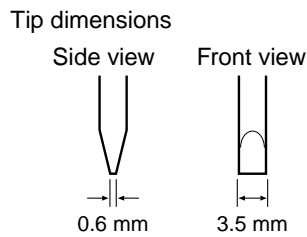

3-3 Communications Line Noise Prevention

3-3-1 Communications Line Noise

The communications line sends and receives high-speed pulse signals, and checks whether the data is correct by checking the sequence of the signals. If the amount of noise on the communications line is too great, the interference will alter the communications signal data, and communications will be impossible. Communications lines are more sensitive and require higher speeds than normal I/O lines, so be sure that noise does not interfere with communications. Use the preventative noise countermeasures described here when configuring the system to ensure smooth system start up.

3-3-2 Grounding the Network

■ Grounding the Network

The DeviceNet Network must be grounded at only one location so that a ground loop is not created. The ground should also be connected as close as possible to the center of the Network. Connect the cable shield to the ground terminal on the communications power supply and then connect to a ground of 100 Ω max., as shown in the following diagram.

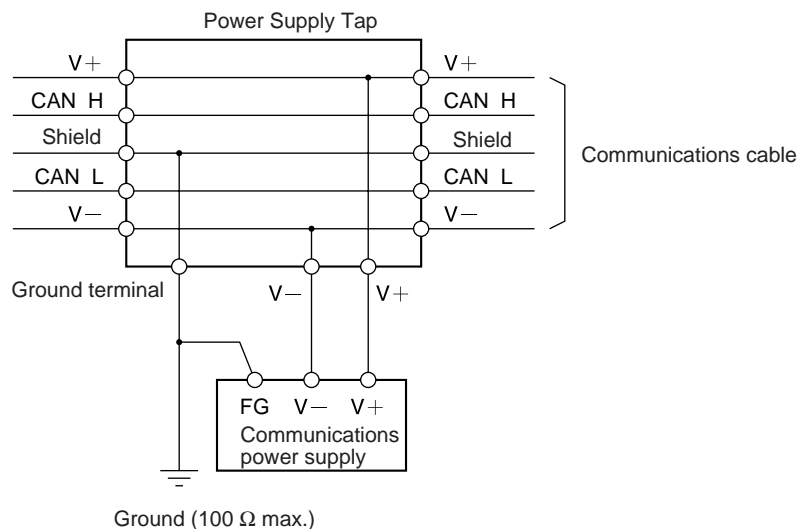

If more than one communications power supply is connected to the same Network, ground only the one nearest the center of the Network. Do not connect the shield wire at the other power supplies.

- Note 1.** Always ground the communications cable shield at one and only one location in the Network.
- Note 2.** Always ground to 100 Ω or less.
- Note 3.** Always use a separate ground. Never use the same ground as for Inverters or other drive system devices.

■ Grounding the DeviceNet Communications Unit

The DeviceNet Communications Unit should be grounded according to DeviceNet recommendations installing a noise filter as shown in the following diagram. The ground is normally wired to the ground terminal (⊕).

Note If the cable grounded to the Inverter is not sufficient and is receiving noise interference, disconnect the grounding cable.

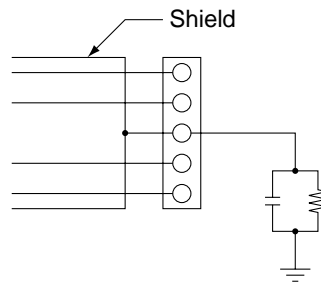

3-3-3 Communications Power Supply Noise Prevention

The communications power supply is the most important power supply in a DeviceNet Network. The following measures will prevent noise in the communications power supply.

- Use the recommended power supply (S82H/S82J) made by OMRON for communications.
- Use an independent power supply for communications.
- Make sure to install a noise filter on the primary AC input side of the communications power supply.
- Always use a control system power supply for the primary AC side of the communications power supply that is not shared with power devices, such as Inverters or motors.

If noise interference remains in cables for which noise countermeasures have been implemented, the following countermeasures may be effective.

● Communications Cable Shielding

Suspend the communications cable shielding wire without grounding it. This will filter the noise that flows from the ground to the communications cable and will filter the noise current that flows in the shielding wire.

● Communications Power Supply

Suspend the communications power supply without grounding it. This will also filter the noise that flows from the communications power supply ground to the communications cable or the noise current that flows in the shielding wire. The switching power supply is usually connected to the case and the capacitor as shown below. The ground (FG) terminal must be suspended and the control panel for the power supply itself must be insulated.

Switching Power Supply Configuration

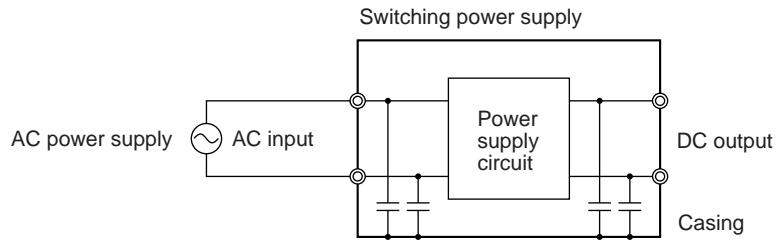

Suspending the Communications Power Supply

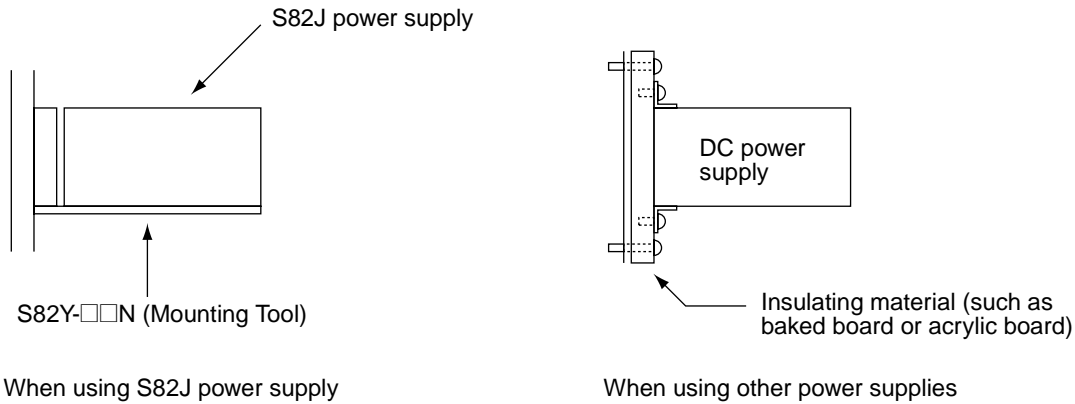

3-3-4 Noise Prevention Wiring

- To prevent inductive noise, do not wire the communications line, PLC power lines, and other power lines near to each other. Keep the power lines for Inverters, motors, regulators, and contactors, the communications lines, and the PLC power lines separated from each other by at least 300 mm. Also, provide separate conduits or ducts for the communications lines and power lines.

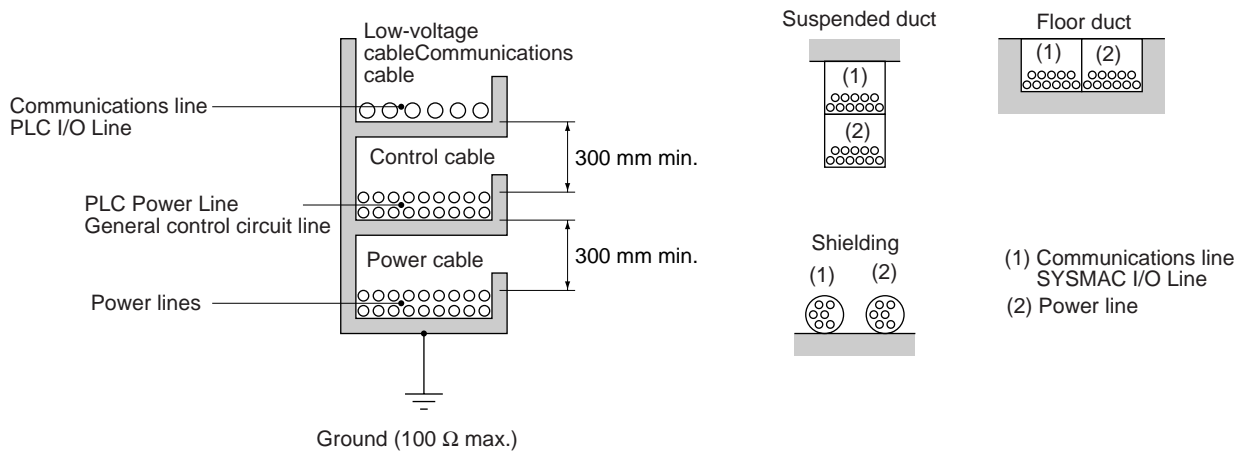

- Do not install communications lines and PLC power lines onto the control panel on which high-voltage devices are mounted.
- Because noise currents flow through metallic equipment (such as casings), the communications cables should be placed as far away from metallic equipment as possible.

- Ground the shielding wire on the communications cable at one point.
- If the same ground is used for the communications cables and communications power supply, there is a possibility that noise may be transmitted through the ground line to the communications line. In order to avoid this, be sure that the power line ground and the grounds for the communications cables and the communications power supply are located as far from each other as possible.

⚠ Caution Connect the communications signal lines (V+, CAN H, shield, CAN L, and V-) so that they do not come into contact with each other.

If noise is generated, check the wiring.

- Communications may be performed even if the V+ and CAN H, or V- and CAN L, are in contact with each other, but differential operation will not be performed, reducing resistance to noise.
- If the shield wire comes into contact with any of the signal lines, a high level of noise will be superimposed on the line, reducing resistance to noise.

3-3-5 Noise Prevention for Peripheral Devices

- Install surge suppressors on devices that generate noise, particularly devices that have an inductive component such as motors, transformers, solenoids, and magnetic coils.

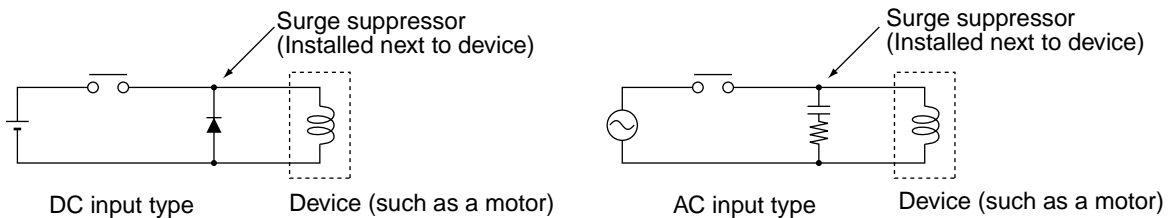

- If a surge suppressor does not fit on the device, installing a ferrite core directly next to the device's contactors, such as a contactor may be effective.

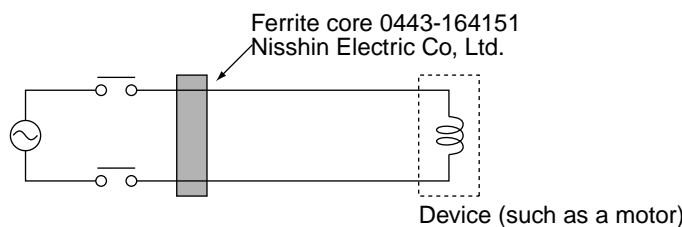

- Insert a line filter on the primary side of the communications power supply.
- When there are two or more communications power supplies, the communications power cables can be grounded by simply connecting a single Power Supply Tap near the center of the communications cable. Do not ground shielding wire at more than one place.

When there is only one power supply

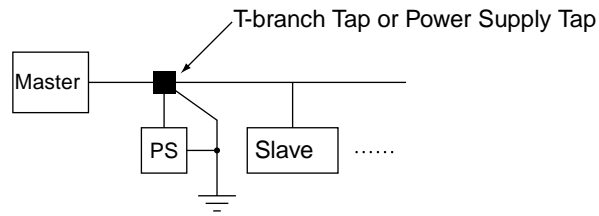

When there are two or more power supplies

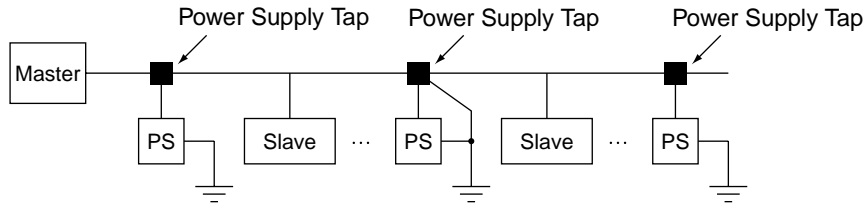

3-4 Conformity to EC Directives

This section explains the concepts relating to and methods for complying with EC Directives for DeviceNet Communications Units and DeviceNet Communications Cards. The applicable directives are the EMC Directive and Low Voltage Directive.

■ Concepts

● EMC Directive

OMRON products that comply with EC Directives are electrical components that are built into and used in manufacturing equipment. They also conform to related EMC standards (see the following note) so that the devices or machines into which they are built can more easily conform to the EMC standards. The actual products have been checked for conformity to EMC standards. It is the responsibilities of the customer, however, to confirm whether the products conform to the standards in the system used by the customer.

EMC-related performance of the OMRON products that comply with EC Directives will vary depending on the configuration, wiring, and other conditions of the equipment or control panel in which the OMRON products are installed. The customer must, therefore, perform the final check to confirm that products and the overall machine conform to EMC standards.

Note Applicable EMC (Electromagnetic Compatibility) standards are as follows:

EMS (Electromagnetic Susceptibility): EN61131-2 or EN61000-6-2

EMI (Electromagnetic Interference): EN61000-6-4

(EM61000-6-3 radiated emission: 10-m regulations)

● Low Voltage Directive

Always ensure that devices operating at voltages of 50 to 1,000 VAC or 75 to 1,500 VDC meet the required safety standards (EN61131-2).

■ Conformity to EC Directives

The following countermeasures must always be implemented to conform to EC Directives when using DeviceNet Communications Units or DeviceNet Communications Cards.

● 3G3MV-PDRT2 DeviceNet Communications Unit

Mount the Unit in a metal control panel, as shown in the diagram. Detailed precautions are given below.

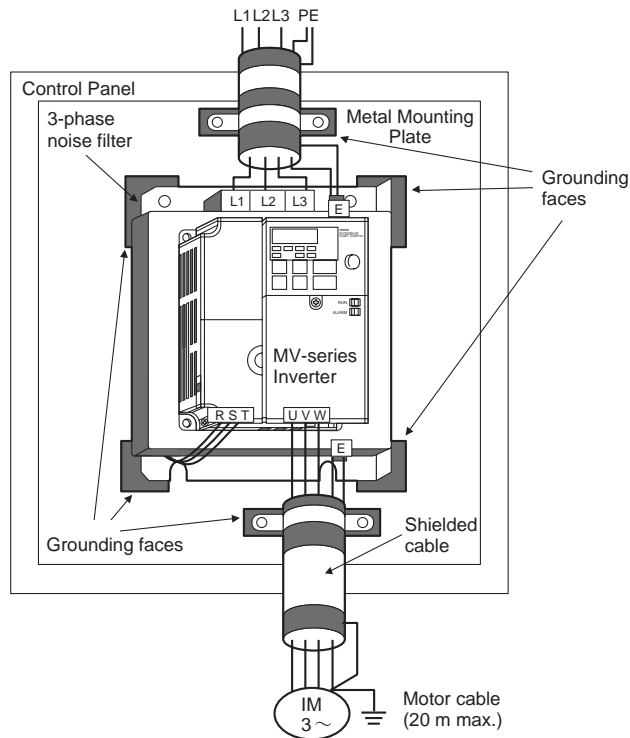
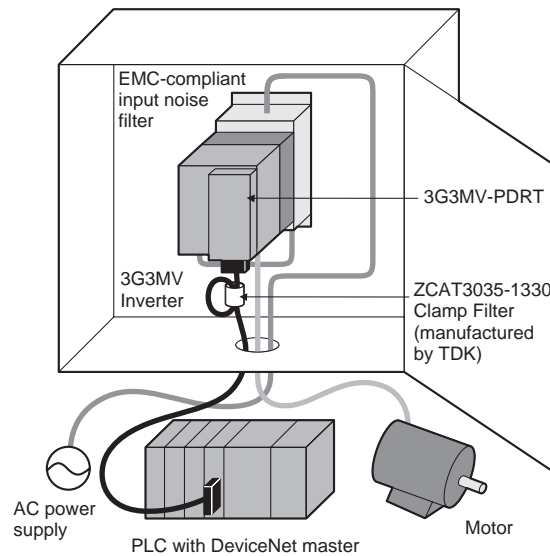

Wiring Diagram for Inverter

- Remove any coating on the footprints of EMC filter, Inverter, and metal mounting plate in order to ensure a metal contact between grounding faces.
- Mount the inverter on top of an EMC-compliant input noise filter and attach any Option Units.
- Use a shielded cable for the Inverter power supply line and connect via the EMC-compliant input noise filter with the shortest cable length possible. Ground the shield at both ends of the cable.

- Use the shortest ground wire possible. For 400-V Inverters, ground the neutral point on the power supply. Ground the metal control panel (and doors) at the same time.
- Use a shielded cable for the cable between the Inverter and motor as well. Keep the cable as short as possible (20 m max.) and ground the shield at both ends of the cable. It is effective to mount a clamp filter right next to the Inverter's output terminals.
- Use a conductive cable clamp to directly ground the shield to the ground plate.
- Ground the motor frame directly and connect the ground from the motor directly to the EMC-compliant input noise filter.
- Use a ZCAT3035-1330 Clamp Filter on the communications cable, wind the cable in a loop around it, and keep it away from the control panel.
- Use conductive packing on the doors of the control panel to increase shielding.
- Do not mount any wireless or other devices designed to generate electromagnetic waves.
- Use reinforced insulation or double insulation for the DC power supply for communications.
- The Inverter's control terminals have only basic insulation. Further insulation must be provided if the terminals are wired to a device that will ultimately come in contact with people.

Grounding the Shield

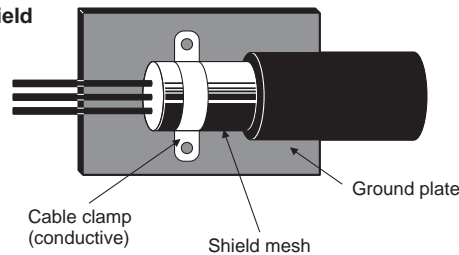

● 3G3RV-PDRT2 DeviceNet Communications Card

Mount the DeviceNet Communications Card as shown in the diagram. Detailed precautions are given below.

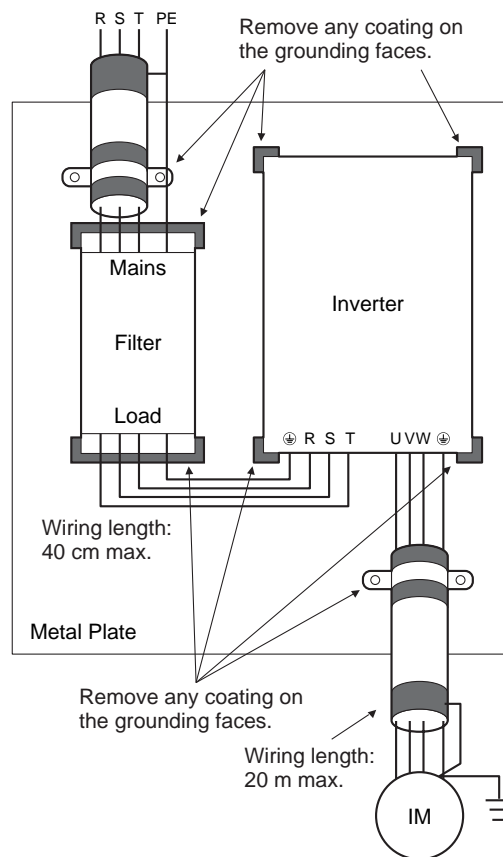

- Remove any coating on the footprints of EMC filter, Inverter, and metal mounting plate in order to ensure a metal contact between grounding faces.
- Attach Option Units to the Inverter.
- Use a shielded cable for the Inverter's power supply line and connect via the EMC-compliant input noise filter with the shortest cable length possible. Ground the shield at both ends of the cable.
- Use the shortest ground wire possible. For 400-V Inverters, ground the neutral point on the power supply.
- Use a shielded cable for the cable between the Inverter and motor as well. Keep the cable as short as possible (20 m max.) and ground the shield at both ends of the cable. It is effective to mount a clamp filter right next to the Inverter's output terminals.
- Use a conductive cable clamp to directly ground the shield to the ground plate.
- Directly ground the motor frame.
- Use a ZCAT3035-1330 Clamp Filter on the communications cable, wind the cable in a loop around it, and keep it away from the control panel.
- Use reinforced insulation or double insulation for the DC power supply for communications.

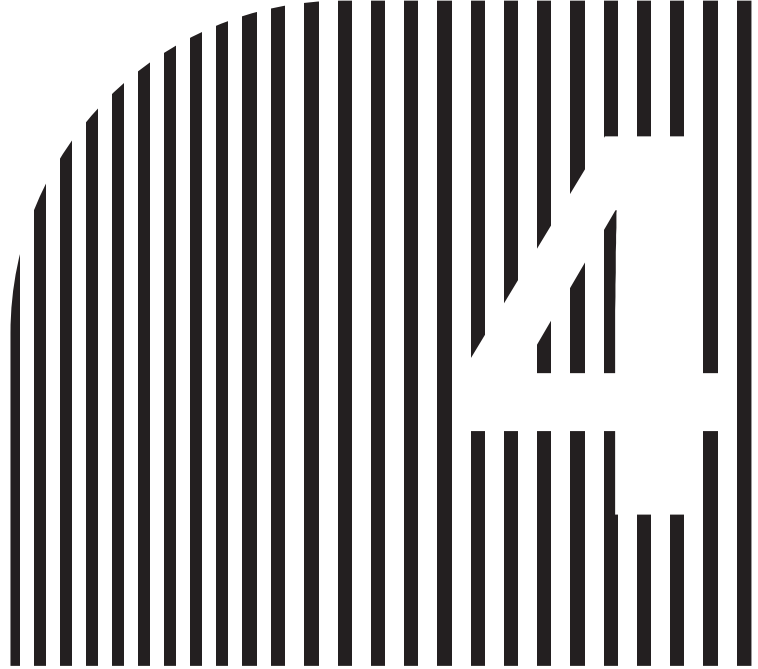

Chapter 4

SYSDRIVE Inverter Settings

- 4-1 SYSDRIVE 3G3MV Settings
- 4-2 SYSDRIVE 3G3RV and 3G3PV Settings
- 4-3 SYSDRIVE 3G3FV Settings

4-1 SYSDRIVE 3G3MV Settings

In order to perform DeviceNet communications, it is necessary to make settings for the Inverter according to the application.

Note The parameters set here are applied to the DeviceNet Communications Unit when the power is turned ON. Turn OFF the power after changing parameters and turn ON again to apply them.

4-1-1 Run Command Selection

Con-stant	Register number (hex)	Name	Content	Setting range	Setting unit	Default setting	Write during operation
n003	0103	Run command source selection	<p>Selects the run/stop command input method for the Inverter. (Becomes valid when the Remote mode is selected from Local/Remote.)</p> <p>0: Run/stop commands from the Digital Operator are valid.</p> <p>1: Terminal block (multi-function input) run commands are valid.</p> <p>2: RS-422/485 communications run commands are valid.</p> <p>3: Run commands from the Optional Unit (DeviceNet Communications Unit) are valid.</p> <p>Note In Local mode, run commands are restricted to those performed using the operation keys of the Digital Operator.</p>	0, 1, 2, 3	1	0	No

Perform the above setting according to the source of the run commands (forward operation, reverse operation, STOP) in the application. When run commands (forward operation, reverse operation, STOP) are always to be made from DeviceNet communications, set to "3."

■ Switching of Run Commands from DeviceNet Communications

There is a switching signal, "Net. Ctrl.," for run commands from the standard remote I/O of the DeviceNet Communications Unit. The input method for run commands can be changed in the following way using the "Net. Ctrl." signal.

Net. Ctrl. = 1 (ON)

Enables run commands from DeviceNet communications (remote I/O run commands become valid) regardless of the setting in n003.

Net. Ctrl. = 0 (OFF)

Enables the run command setting in n003.

4-1-2 Frequency Reference Selection

Con-stant	Register number (hex)	Name	Content	Setting range	Setting unit	Default setting	Write during operation
n004	0104	Frequency reference source selection	<p>Selects the frequency reference input method for the Inverter. (Becomes valid when the Remote mode is selected from Local/Remote.)</p> <p>0: Digital Operator frequency settings are valid.</p> <p>1: Frequency reference 1 (n024) is valid.</p> <p>2: Frequency reference control terminal (0 to 10-V voltage input) is valid.</p> <p>3: Frequency reference control terminal (4 to 20-mA current input) is valid.</p> <p>4: Frequency reference control terminal (0 to 20-mA current input) is valid.</p> <p>5: Pulse train reference control terminal is valid.</p> <p>6: Frequency reference from RS-422/485 communications is valid.</p> <p>7: Multi-function analog voltage input (0 to 10 V) is valid. (Used when two analog inputs are required for PID control. Normally not used.)</p> <p>8: Multi-function analog current input (4 to 20 mA) is valid. (Used when two analog inputs are required for PID control. Normally not used.)</p> <p>9: Frequency reference from the Optional Unit (DeviceNet Communications Unit) is valid.</p>	0 to 9	1	0	No

Perform the above setting according to the source of the frequency reference in the application. When frequency references from the DeviceNet communications are to be always used, set to "9." If this setting is performed, frequency reference 1 can only be set through DeviceNet communications. However, frequency references 2 to 16 and the inching frequency can be set from DeviceNet communications or the Digital Operator regardless of the setting of n004.

■ Switching of Frequency References from DeviceNet Communications

There is a switching signal, “Net. Ref.,” for frequency references (speed references) from the standard remote I/O of the DeviceNet Communications Unit. The input method for frequency references can be changed in the following ways using the “Net. Ref.” signal.

Net. Ref. = 1 (ON)

Enables frequency references from DeviceNet communications (remote I/O frequency references become valid) regardless of the setting in n004.

Net. Ref. = 0 (OFF)

Enables the frequency reference setting in n004.

4-1-3 Frequency Reference Settings and Display Units

Perform the following settings to specify units for data related to frequencies (speeds) used in DeviceNet communications. The standard unit used with DeviceNet is r/min, so always set the number of motor poles.

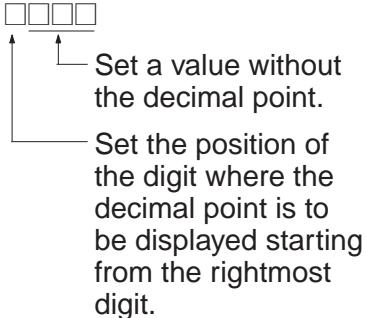
Con-stant	Register number (hex)	Name	Content	Setting range	Setting unit	Default setting	Write during operation
n035	0123	Frequency reference setting and display units	<p>Sets the units for the frequency reference and frequency monitor that are set and referred to by the Digital Operator.</p> <p>0: Hz units 1: 0.1% units (max. frequency is 100%) 2 to 39: r/min units (Set the number of motor poles) 40 to 3999: Optional Unit settings. (Specifies the value used to set and display the maximum frequency.)</p>  <p>Example: To display the maximum frequency as "50.0," specify "1500."</p>	0 to 3999	1	0	No

Note 1. Only the following parameters and monitor items will change for this setting.

Parameters

n024 to n032: Frequency references 1 to 8 and inching frequency command

n120 to n127: Frequency references 9 to 16

Monitor Items

U-01: Reference frequency monitor

U-02: Output frequency monitor

Note 2. The settings are valid in either Local or Remote mode.

4-2 SYSDRIVE 3G3RV and 3G3PV Settings

In order to perform DeviceNet communications, it is necessary to make settings for the Inverter according to the application.

Note The parameters set here are applied to the DeviceNet Communications Card when the power is turned ON. Turn OFF the power after changing parameters and turn ON again to apply them.

4-2-1 Frequency Reference Selection

- Select the method for inputting frequency references to the Inverter. Select the method suitable for the application.

Parameter No.	Set value	Contents		Default setting
b1-01	0	Digital Operator	Value set in d1-01 used.	1
	1	Control circuit terminals	Set using analog input from control circuit terminals.	
	2	RS-422/485 communications	Set via RS-422/485 communications.	
	3	Optional Card	Set using DeviceNet Communications Card.	
	4	Pulse input	Set using pulse input from control circuit terminals.	

- When frequency references from the DeviceNet communications are to be always used, set to “3.” If this setting is performed, frequency reference 1 can only be set through DeviceNet communications. However, parameter values set from DeviceNet communications or the Digital Operator are used for 3G3RV Inverters' frequency references 2 to 16 and inching frequency reference (d1-02 to d1-17) regardless of the setting of b1-01.

■ Switching of Frequency References from DeviceNet Communications

There is a switching signal, “Net. Ref.,” for frequency references (speed references) from the standard remote I/O of the DeviceNet Communications Card. The input method for frequency references can be changed in the following ways using the “Net. Ref.” signal.

Net. Ref. = 1 (ON)

Enables frequency references from DeviceNet communications (remote I/O frequency references become valid) regardless of the setting in b1-01.

Net. Ref. = 0 (OFF)

Enables the frequency reference setting in b1-01.

4-2-2 Inverter Operation Command Selection

- Select the method for inputting Run and Stop Commands to the Inverter. Select the method suitable for the application.

Parameter No.	Set value	Contents		Default setting
b1-02	0	Digital Operator	RUN and STOP Keys on the Digital Operator	1
	1	Control circuit terminals	Operation command input from control circuit terminals	
	2	RS-422/485 communications	Operation commands received via RS-422/485 communications	
	3	Optional Card	Operation commands using DeviceNet Communications Card	

- When operation commands (forward, reverse, stop) from the DeviceNet communications are to be always used, set to “3.”

■ Switching of Operation Commands from DeviceNet Communications

There is a switching signal, “Net. Ctrl.,” for operation commands from the standard remote I/O of the DeviceNet Communications Card. The input method for operation commands can be changed in the following ways using the “Net. Ctrl.” signal.

Net. Ctrl. = 1 (ON)

Enables operation commands from DeviceNet communications (remote I/O operation commands become valid) regardless of the setting in b1-02.

Net. Ctrl. = 0 (OFF)

Enables the operation command setting in b1-02.

4-2-3 DeviceNet Communications Settings

The parameters below are for functions that are exclusive to DeviceNet communications. Set these parameters according to the desired application.

Parameter No.	Name	Contents	Setting range	Default setting
	Operator display			
F6-01	Communications fault operation	Select the Inverter operation performed when a communications fault is detected. 0: Decelerates to a stop using C1-02 deceleration time/fault detection 1: Coasts to a stop/fault detection 2: Decelerates to a stop using the C1-09 emergency stop time/fault detection 3: Continues operating/alarm detection (See note.)	0 to 3	1
	Comm Bus Flt Sel			
F6-02	Communications external fault input: detection method	Select the detection method used for the communications external fault input from communications (DeviceNet Communications Card). 0: Faults always detected. 1: Faults detected only while running (i.e., when Run Commands are input)	0, 1	0
	EFO Detection			
F6-03	Communications external fault input: operation	Select the Inverter operation performed when there is a communications external fault (EFO) input from communications (DeviceNet Communications Card). 0: Decelerates to a stop using C1-02 deceleration time/fault detection 1: Coats to a stop/fault detection 2: Decelerates to a stop using the C1-09 emergency stop time/fault detection 3: Continues operating/alarm detection	0 to 3	1
	EFO Fault Action			
F6-04	Not used	Do not set.	---	0
	Trace Sample Tim			

Note If F6-01 is set to 3 (continues operating), the Inverter will continue operating when a communications fault occurs according to the contents of settings immediately before. Be sure to take any steps necessary to ensure safety, such as installing a limit switch or an emergency stop switch.

4-2-4 Frequency Reference Settings and Display Units

- Perform the following settings to specify units for data related to frequencies (speeds) used in DeviceNet communications.
- The standard unit used with DeviceNet is r/min, so always set the number of motor poles.

Parameter No.	Set value	Contents	Default setting
o1-03	0	0.01 Hz units	0
	1	0.01% units (max. frequency is 100%)	
	2 to 39	r/min units (Set the number of motor poles.)	
	40 to 39,999	<p>Specifies the value used to set and display the maximum frequency.</p> <p>□□□□□</p> <p>↑ ↑</p> <p>Set a 4-digit value without the decimal point.</p> <p>Set the position of the digit where the decimal point is to be displayed starting from the rightmost digit.</p> <p>Example: To display the maximum frequency as "200.0" specify "12000."</p>	

4-3 SYSDRIVE 3G3FV Settings

In order to perform DeviceNet communications, it is necessary to make settings for the Inverter according to the application.

Note The parameters set here are applied to the DeviceNet Communications Card when the power is turned ON. Turn OFF the power after changing parameters and turn ON again to apply them.

4-3-1 Frequency Reference Selection

- Select the method for inputting frequency references to the Inverter. Select the method suitable for the application.

Parameter No.	Set value	Contents		Default setting
b1-01	0	Digital Operator	Value set in d1-01 used.	1
	1	External terminals	Set using analog input from control circuit terminals.	
	2	Not used (Do not set.)		
	3	Optional Card	Set using DeviceNet Communications Card.	

- When frequency references from the DeviceNet communications are to be always used, set to “3.” If this setting is performed, frequency reference 1 can only be set through DeviceNet communications. However, parameter values set from DeviceNet communications or the Digital Operator are used for frequency references 2 to 8 and the inching frequency reference (d1-02 to d1-09) regardless of the setting of b1-01.

■ Switching of Frequency References from DeviceNet Communications

There is a switching signal, “Net. Ref.,” for frequency references (speed references) from the standard remote I/O of the DeviceNet Communications Card. This function cannot be used with the 3G3FV.

When it is necessary to switch frequency references from DeviceNet communications, change the setting in parameter b1-01 with an explicit message (Class 64 hex, Instance 01 hex, Attribute 03 hex).

4-3-2 Inverter Operation Command Selection

- Select the method for inputting Run and Stop Commands to the Inverter. Select the method suitable for the application.

Parameter No.	Set value	Contents		Default setting
b1-02	0	Digital Operator	Operation commands from the Digital Operator	
	1	External terminals	Control circuit terminals (sequence input)	
	2	Not used (Do not set.)		
	3	Optional Card	Operation commands using DeviceNet Communications Card	

- When operation commands (forward, reverse, stop) from the DeviceNet communications are to be always used, set to 3."

■ Switching of Operation Commands from DeviceNet Communications

There is a switching signal, "Net. Ctrl.," for operation commands from the standard remote I/O of the DeviceNet Communications Card. This function cannot be used with the 3G3FV.

When it is necessary to select the operation command from DeviceNet communications, change the setting in parameter b1-02 with an explicit message (Class 64 hex, Instance 01 hex, Attribute 04 hex).

4-3-3 DeviceNet Communications Settings

The parameters below are for functions that are exclusive to DeviceNet communications. Set these parameters according to the desired application.

Parameter No.	Name	Contents	Setting range	Default setting
	Operator display			
F9-01	Communications external fault input: input type	Select the type of input used for the communications external fault input from communications (DeviceNet Communications Card). 0: N.O. input (external fault detected when 1) 1: N.C. input (external fault detected when 0)	0, 1	0
	EFO Selection			
F9-02	Communications external fault input: detection method	Select the detection method used for the communications external fault input from communications (DeviceNet Communications Card). 0: Always detect. 1: Detect during operation (i.e., when operation commands are input).	0, 1	0
	EFO Detection			

Parameter No.	Name	Contents	Setting range	Default setting
	Operator display			
F9-03	Communications external fault input: operation	Select the Inverter operation performed when there is a communications external fault input from communications (DeviceNet Communications Card). 0: Decelerates to a stop using C1-02 deceleration time/fault detection 1: Coats to a stop/fault detection 2: Decelerates to a stop using the C1-09 emergency stop time/fault detection 3: Continues operating/alarm detection	0 to 3	1
	EFO Fault Action			
F9-04	Not used	Do not set.	---	0
	Trace Sample Tim			
F9-05	Torque reference/torque limit selection from communications	When operating in flux vector control mode, this setting enables or disables torque reference and torque limit values input from communications (DeviceNet Communications Card). (See note 1.) 0: Torque reference/torque limit from communications disabled. 1: Torque reference/torque limit from communications enabled.	0, 1	0
	Torq Ref/Lmt Sel			
F9-06	Communications fault operation	Select the Inverter operation performed when a communications fault is detected. 0: Decelerates to a stop using C1-02 deceleration time/fault detection 1: Coats to a stop/fault detection 2: Decelerates to a stop using the C1-09 emergency stop time/fault detection 3: Continues operating/alarm detection (See note 2.)	0 to 3	1
	BUS Fault Sel			

Note 1. Be sure to set F9-05 to 0 when using flux vector control. If used with the default setting (1), the torque reference/torque limit will be interpreted as zero and there will be no torque output unless there is a torque reference/torque limit from control I/O remote I/O.

Note 2. If F9-06 is set to 3 (continues operating), the Inverter will continue operating when a communications fault occurs according to the contents of settings immediately before. Be sure to take any steps necessary to ensure safety, such as installing a limit switch or an emergency stop switch.

4-3-4 Frequency Reference Settings and Display Units

- Perform the following settings to specify units for data related to frequencies (speeds) used in DeviceNet communications.
- The standard unit used with DeviceNet is r/min, so always set the number of motor poles.

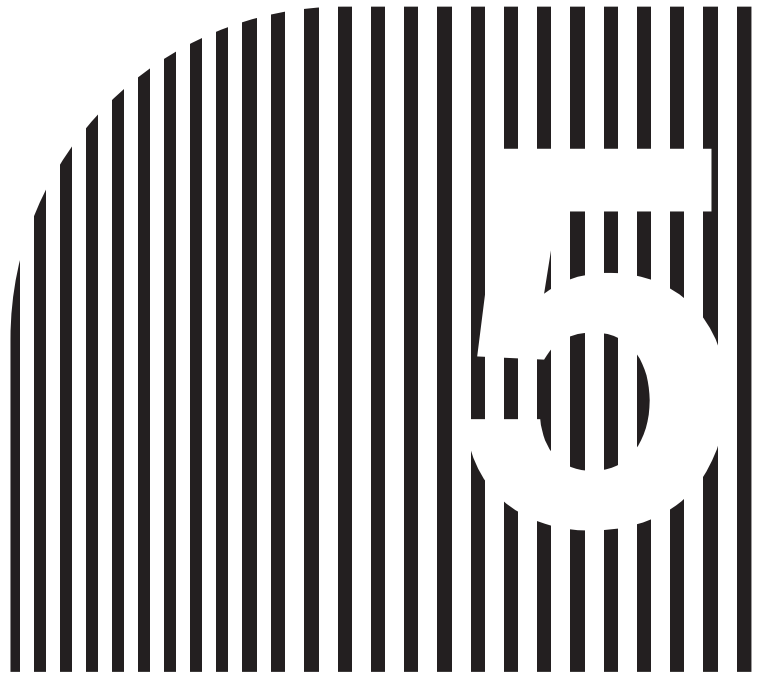

Parameter No.	Set value	Contents	Default setting
o1-03	0	0.01 Hz units	0
	1	0.01% units (max. frequency is 100%)	
	2 to 39	r/min units (Set the number of motor poles.)	
	40 to 39,999	<p>Specifies the value used to set and display the maximum frequency.</p> <p>□□□□□</p> <p>↑ ↑</p> <p> Set a 4-digit value without the decimal point.</p> <p> Set the position of the digit where the decimal point is to be displayed starting from the rightmost digit.</p> <p>Example: To display the maximum frequency as "200.0" specify "12000."</p>	



Chapter 5

Remote I/O Functions

- 5-1 Overview of Remote I/O Functions
- 5-2 Switching the Remote I/O Function
- 5-3 Basic Remote I/O
- 5-4 Standard Remote I/O
- 5-5 Special Remote I/O Operation
- 5-6 Control Remote I/O Operation
- 5-7 Unit Status

-  **Caution** Be sure to set the switches correctly and check the settings before starting operation. Not doing so may result in malfunction or damage to the product
-  **Caution** Install devices to stop operation as required to ensure safety. Equipment damage may result. This is particularly important when operation is set to continue for communications errors because the Inverter will continue operation.
-  **Caution** Do not carelessly change Inverter's settings. Doing so may result in injury or damage to the product.

5-1 Overview of Remote I/O Functions

This section provides an overview of the remote I/O functions, which provide communications between the Inverter (SYSDRIVE 3G3MV, 3G3RV, or 3G3FV) and the Master.

5-1-1 Overview of Remote I/O Functions

The following table lists the four remote I/O functions that are supported. Use the remote I/O functions most suitable for your application. Also, the Inverter's status can be monitored easily by attaching the status flags (16 bits) to each function and allocating them in the Master. The Unit status flags can also be allocated independently in the Master.

Note Refer to 5-7 *Unit Status* for details on the Unit status.

Function	Description
Basic remote I/O	This remote I/O function is compatible to DeviceNet remote I/O function. The basic remote I/O function is more limited than the standard remote I/O function.
Standard remote I/O	This remote I/O function is the factory setting in the DeviceNet Communications Unit/Card. General Inverter control can be performed with this remote I/O function.
Special remote I/O	This remote I/O function is a proprietary OMRON format, not the remote I/O format specified by DeviceNet. The special remote I/O function can be used to read/set all of a 3G3MV, 3G3RV, or 3G3FV Inverter's parameters and take advantage of all of the Inverter's functions.
Control I/O remote I/O	This remote I/O function is a proprietary OMRON format, not the remote I/O format specified by DeviceNet. The control I/O remote I/O function's features and arrangement match the Inverter's control terminal I/O signals, so it can be used for communications with the Inverter's multi-function inputs. There are also default settings in which the Unit status (16 bits) or multi-function input monitor data (8 bits) is attached to this remote I/O function for allocation in the Master (data connection path setting)

5-1-2 Selecting the Remote I/O Function

Select the desired remote I/O function with the DeviceNet Configurator or an Explicit message. Refer to 5-2 *Switching the Remote I/O Function* for details on switching the remote I/O function from the Configurator.

■ Selecting with the Default Connection Path

With the Slave's "default connection path" setting, any remote I/O function can be selected from a pull-down menu (see the following table). Use this method to set the remote I/O function when the Master is a CVM1/CV-series DeviceNet (Master) Unit, C200HX/HG/HE or C200HS DeviceNet (Master) Unit, or another company's DeviceNet (Master) Unit.

Default Connection Path List

Basic remote I/O
Standard remote I/O
Special remote I/O
Control I/O remote I/O
Control I/O remote I/O + Unit status
Control I/O remote I/O + Multi-function input monitor

■ Selecting with the Connection Path

The remote I/O function can be switched with the Master's "connection path" setting. The data allocated to a POLL or COS connection can be selected from a pull-down list (see the following table). In a POLL connection, input data and output data must be allocated in pairs.

Connection Path List

Remote I/O function	IN/OUT	Data
Basic remote I/O	IN	46 hex: Basic Speed Control Status
	OUT	14 hex: Basic Speed Control Command
Standard remote I/O	IN	47 hex: Standard Speed Control Status
	OUT	15 hex: Standard Speed Control Command
Special remote I/O	IN	96 hex: Special I/O Response
	OUT	64 hex: Special I/O Command
Control I/O remote I/O	IN	97 hex: Extended Control Status
	OUT	65 hex: Extended Control Command
Control I/O remote I/O + Unit status	IN	98 hex: Extended Control Status + Unit Status
	OUT	65 hex: Extended Control Command
Control I/O remote I/O + Multi-function input monitor	IN	99 hex: Extended Control Status + Multi-function Input Monitor
	OUT	65 hex: Extended Control Command
Unit status	IN	9A hex: Unit Status
Multi-function input monitor	IN	9B hex: Multi-function Input Monitor

Note It is possible to use remote I/O communications combinations that do not exist in the Slave's default connection paths (such as standard remote I/O + Unit status or special remote I/O + Unit status) by selecting one more of the IN data elements and adding a COS connection.

■ Setting with an Explicit Message

The remote I/O function can also be switched by sending an explicit message.

If the DeviceNet Configurator is used, the settings are easier to perform because of the customized settings windows, but in some cases explicit messages may be preferred. Refer to *Chapter 6 Message Communications* and *10-2 Objects* for details.

Example

The default connection path can be changed by setting one of the following values for Class 94 hex, Instance 01 hex, Attribute 64 hex and then resetting the power supply.

Data	Default connection path
0	Basic I/O
1	Standard I/O
2	Special I/O
3	Extended Control I/O
4	Extended Control I/O + Unit status
5	Extended Control I/O + Multi-function Input Monitor

5-2 Switching the Remote I/O Function

To use remote I/O operations other than the default setting (standard remote I/O), it is necessary to switch the remote I/O operation. There are two ways to switch the remote I/O function with the DeviceNet Configurator.

- Open the Slave's *Edit Device Parameters* Window in the Configurator, select the desired remote I/O function from the pull-down list (default connection path setting), and download the settings.
- Open the Master's *Edit Device Parameters* Window in the Configurator and set the connection path in the Advanced setting Window.

5-2-1 Switching with the Default Connection Path (Slave)

Use the following procedure to switch the Slave's remote I/O function with the Configurator.

■ Procedure

1. Select the desired Slave's icon in the Configurator, right click, and select **Parameters/Edit** from the popup menu to open the Edit Device Parameters Window.
2. Click the **General** Tab and execute the Upload operation to read the Slave's parameters.
3. On the *General* Tab Page, select the desired remote I/O function pattern from the Default Connection Path List.

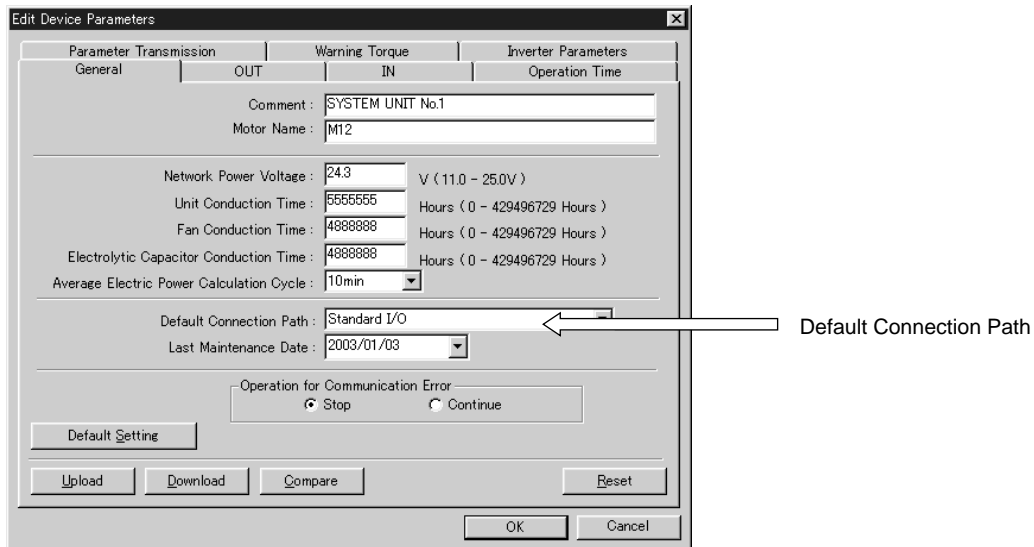

4. Execute the Download operation. (The Download operation downloads all of the data together, including the Inverter's parameters and settings other than those on the *General* Tab Page.)
5. Click the **Reset** Button to reset the Slave and enable the new setting.

5-2-2 Switching with the Connection Path (Master)

Use the following procedure to switch the Master's remote I/O function with the Configurator. In this example, the remote I/O function is set to *Control I/O remote I/O + Unit status*.

■ Procedure

1. Locate the Master in the Network Configuration Window and either double-click the Master or right-click and select **Parameters/Edit** from the pop-up menu to display the *Edit Device Parameters* Window. Select the desired Slave from the *General* Tab Page.

2. Click the  Button to move the desired Inverter to the *Register Devices List*.

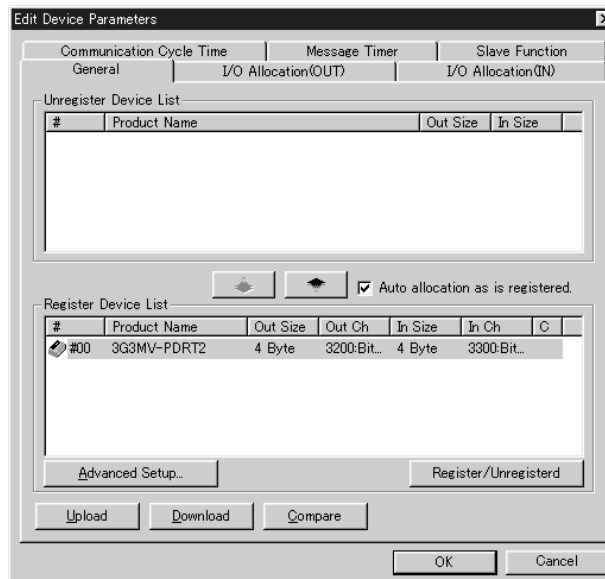

Note The **Register/Unregister** Button can be clicked at this point to allocate data with the remote I/O function selected in the Slave. The following steps explain how to allocate data freely, so steps 3 to 10 are not required if data will be allocated automatically. Proceed to step 11 (Download) if using automatic allocation.

3. Select the desired Inverter from the *General* Tab Page and click the **Advanced Setup** Button.

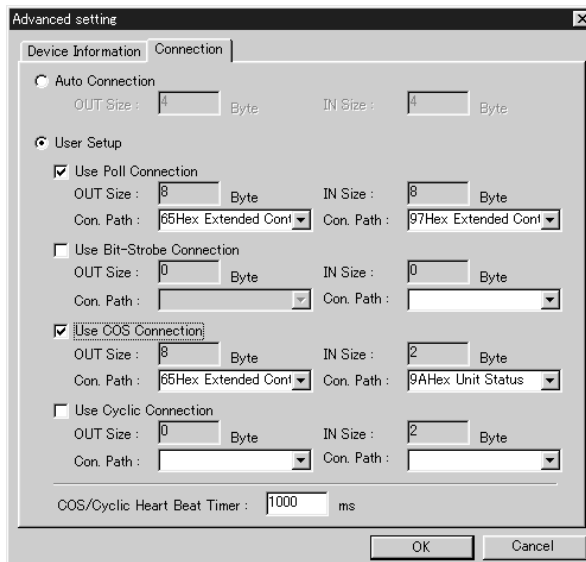

4. Click the **Connection** Tab of the *Advanced Setting* Window and select **User Setup**.
5. Select *Use Poll Connection* and *Use COS connection*.
6. Set *Extended Control Status* (Control I/O remote I/O) for the IN data and *Extended Control Command* (Control I/O remote I/O) for the OUT data as the poll connection's connection paths.
7. Set *Unit Status* for the IN data as the COS connection's connection path.

Note When a CS/CJ-series DeviceNet (Master) Unit is being used, set the COS connection's OUT data to the same setting set for the poll connection's OUT data. If the connection paths do not match, it will not be possible to select both *Use Poll Connection* and *Use COS Connection*.

Reference

The following connection path settings will be allocated automatically if you select the connection but leave the connection path settings blank.

Connection	OUT (PLC → Inverter)	IN (PLC ← Inverter)
Poll	Slave's default connection path setting	Slave's default connection path setting
Bit-strobe	Not allocated.	Slave's default connection path setting
COS	Not allocated.	Unit Status 154 decimal (9A hex)
Cyclic	Not allocated.	Unit Status 154 decimal (9A hex)

8. Click the **OK** Button to close the *Advanced Settings* Window.

9. Click the **I/O Allocation (IN)** Tab and display the *Edit I/O Allocate* Window. In the *Poll* settings, set *Block: 1* and *Allocated: 3300* (user-set). In the *COS* settings, set *Block: 2* and *Allocated: 3500* (user-set).

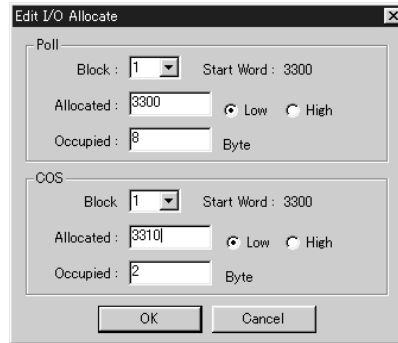

10. Set the *I/O Allocation (OUT)* settings in the same way. Set *Block: 1* and *Allocated: 3200* (user-set).

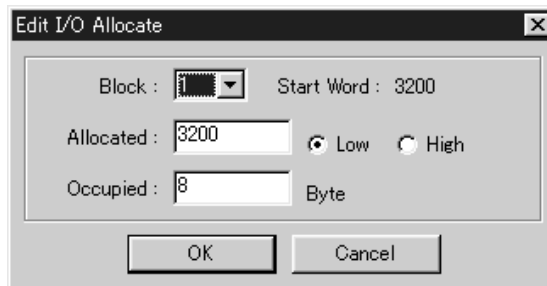

11. Return to the *General* Tab Page and click the **Download** Button.
12. When the download has been completed, restart with the new settings.

Reference

- When *Auto allocation as is registered* is selected on the Master's *General* Tab Page, a message will appear every time that connection path settings are changed. The message will indicate that the present I/O allocation was cleared because the connection was changed. When making connection path settings, clear the *Auto allocation as is registered* check box before registering the Slaves.
- When connection settings are changed, a warning mark may be displayed by the Inverter Slave's icon. In this case, click the **Get I/O Size from the Scan List** Button on the *I/O Information* Tab Page of the Inverter Slave's *Property* Window and edit the information so that the I/O information for the Slave's icon matches the Master's scan list. (For details, refer to *7-1-3 Network Connection Precautions*.)

5-3 Basic Remote I/O

Basic remote I/O is the basic built-in DeviceNet remote I/O function.

The basic remote I/O function is more limited than the standard remote I/O function.

■ I/O Format (Allocated Words)

● Outputs (PLC to Inverter)

Instance ID: 20 Decimal (14 Hex)

Byte number			Bit 7	Bit 6	Bit 5	Bit 4	Bit 3	Bit 2	Bit 1	Bit 0
Wd n	Right-most	0						Fault Reset		Forward/stop
	Left-most	1								
Wd n+1	Right-most	2	Rotational speed reference (rightmost data)							
	Left-most	3	Rotational speed reference (leftmost data)							

● Inputs (Inverter to PLC)

Instance ID: 70 Decimal (46 Hex)

Byte number			Bit 7	Bit 6	Bit 5	Bit 4	Bit 3	Bit 2	Bit 1	Bit 0
Wd m	Right-most	0						During forward run		Fault
	Left-most	1								
Wd m+1	Right-most	2	Rotational speed monitor (rightmost data)							
	Left-most	3	Rotational speed monitor (leftmost data)							

Note A shaded box indicates that the bit is not used.

■ Bit and Data Functions

● Output Bit Details

Name	Meaning
Forward/stop	0: Stop, 1: Forward
Fault Reset	0: ---, 1: Fault reset

● Output Data Details

Word address	n+1															
Bit	15	14	13	12	11	10	9	8	7	6	5	4	3	2	1	0
Signal name	Rotational speed reference data															
Content	Communications data = Rotational speed reference x 2 ^a a: Speed scale value of Class 2A, Instance 01, Attribute 16 (Initial value: 0) (Setting range: 0 to the rotational speed at maximum frequency) * The speed scale is assigned with the message function. For instructions on how to change it, refer to <i>Chapter 6 Message Communications</i> . * The units for the rotational speed reference are set in n035/o1-03 (frequency reference setting and display units). * Setting example (providing a reference of 1,800 r/min): When the speed scale value is "0" and the number of motor poles is set in n035/o1-03 (so units are r/min): 1,800 r/min → 1,800 x2 ⁰ → 1,800 → 0708 hex															

- Note 1.** In this manual, the parameter location for the 3G3MV is written ahead of the parameter location for the 3G3RV/3G3PV/3G3FV, so "n035/o1-03" indicates a parameter location of n035 for the 3G3MV and parameter location of o1-03 for the 3G3RV/3G3PV/3G3FV.
- Note 2.** Under the DeviceNet protocol, the unit for the speed reference is fixed as r/min. The number of motor poles (2 to 39) must be set in parameter n035/o1-03 (frequency reference setting and display units) when using DeviceNet (open network).
- Note 3.** If the setting is not within the proper range, the previous data will be retained and the designated rotational speed will not be entered.

● Input Bit Details

Name	Meaning
Fault	0: Normal, 1: Fault
During forward run	0: Stopped, 1: Running forward

● Input Data Details

Word address	m+1															
Bit	15	14	13	12	11	10	9	8	7	6	5	4	3	2	1	0
Signal name	Rotational speed monitor data															
Content	Communications data = Rotational speed monitor x 2 ^a a: Speed scale value of Class 2A, Instance 01, Attribute 16 (Initial value: 0) * The speed scale is assigned to the message function. For instructions on how to change it, refer to <i>Chapter 6 Message Communications</i> . * The unit for the rotational speed monitor is set in n035/o1-03 (frequency reference setting and display units) * Data conversion example: When the speed scale value is "0" and the number of motor poles is set in n035/o1-03, and the read data is 03E8 hex: 03E8 hex → 1,000 → 1,000/2 ⁰ → 1,000 r/min															

Note Under the DeviceNet protocol, the unit for the speed reference is fixed as r/min. The number of motor poles (2 to 39) must be set in parameter n035/o1-03 (frequency reference setting and display units) when using DeviceNet (open network).

5-4 Standard Remote I/O

Standard remote I/O is the factory setting for the DeviceNet Communications Unit/Card. General Inverter control can be performed with this remote I/O function.

■ I/O Format (Allocated Words)

● Outputs (PLC to Inverter)

Instance ID: 21 Decimal (15 Hex)

Byte number			Bit 7	Bit 6	Bit 5	Bit 4	Bit 3	Bit 2	Bit 1	Bit 0
Wd n	Right-most	0		Net Reference	Net Control			Fault Reset	Reverse/stop	Forward/stop
	Left-most	1								
Wd n+1	Right-most	2	Rotational speed reference (rightmost data)							
	Left-most	3	Rotational speed reference (leftmost data)							

● Inputs (Inverter to PLC)

Instance ID: 71 Decimal (47 Hex)

Byte number			Bit 7	Bit 6	Bit 5	Bit 4	Bit 3	Bit 2	Bit 1	Bit 0
Wd m	Right-most	0	At Reference	Reference From Net	Control From Net	Inverter Ready	During reverse run	During forward run	Alarm	Fault
	Left-most	1								
Wd m+1	Right-most	2	Rotational speed monitor (rightmost data)							
	Left-most	3	Rotational speed monitor (leftmost data)							

Note A shaded box indicates that the bit is not used.

■ Bit and Data Functions

● Output Bit Details

Name	Function
Forward/stop	0: Stop, 1: Forward
Reverse/stop	0: Stop, 1: Reverse
Fault Reset	0: ---, 1: Fault reset
Net Control	0: Specified in n003/b1-02, 1: Device Net (See notes 1 and 2.)
Net Reference	0: Specified in n004/b1-01, 1: Device Net (See notes 1 and 3.)

- Note 1.** In this manual, the parameter location for the 3G3MV is written ahead of the parameter location for the 3G3RV/3G3PV/3G3FV, so “n003/b1-02” indicates a parameter location of n003 for the 3G3MV and parameter location of b1-02 for the 3G3RV/3G3PV/3G3FV.
- Note 2.** Net Control is used to change the run command as follows (cannot be changed while the Inverter is running):
 0: The run command input method specified by the run command source selection (n003/b1-02) is used.
 1: Operate by DeviceNet regardless of the setting in n003/b1-02 (according to the run command in word n, bits 0 and 1). (This setting is invalid in the 3G3FV Inverters.)
- Note 3.** Net Reference is used to specify the frequency reference as follows (cannot be changed while the Inverter is running):
 0: The frequency reference input method specified by the frequency reference source selection (n004/b1-01) is used.
 1: Operate by DeviceNet regardless of the setting in n004/b1-01. (Operates with rotational speed reference in word n+1.) (This setting is invalid in the 3G3FV Inverters.)

● Output Data Details

Word address	n+1															
Bit	15	14	13	12	11	10	9	8	7	6	5	4	3	2	1	0
Signal name	Rotational speed reference data															
Content	Communications data = Rotational speed reference x 2 ^a a: Speed scale value of Class 2A, Instance 01, Attribute 16 (Initial value: 0) (Setting range: 0 to the rotational speed at maximum frequency) * The speed scale is assigned with the message function. For instructions on how to change it, refer to <i>Chapter 6 Message Communications</i> . * The unit for the rotational speed reference is set in n035/o1-03 (frequency reference setting and display units) * Setting example (providing reference of 1,800 r/min): When the speed scale value is “0” and the number of motor poles is set in n035/o1-03 (so unit is r/min): 1,800 r/min → 1,800 x 2 ⁰ → 1,800 → 0708 hex															

- Note 1.** Under the DeviceNet protocol, the unit for the speed reference is fixed as r/min. The number of motor poles (2 to 39) must be set in parameter n035/o1-03 (frequency reference setting and display units) when using DeviceNet (open network).
- Note 2.** If the setting is not within the proper range, the previous data will be retained and the designated rotational speed will not be entered.

● Input Bit Details

Name	Function
Fault	0: Normal, 1: Fault
Alarm (Minor Fault)	0: Normal, 1: Alarm (minor fault)
During forward run	0: Stop/reverse, 1: During forward run (See note 1.)
During reverse run	0: Stop/forward, 1: During reverse run (See note 2.)
Inverter Ready	0: Preparing, 1: Ready
Control From Net	0: Not DeviceNet (n003/b1-02), 1: Device Net (See note 3.)
Reference From Net	0: Not DeviceNet (n004/b1-01), 1: DeviceNet (See note 4.)
At Reference	0: Accelerating or Decelerating, 1: At reference

- Note 1.** Forward Operation indicates either forward run status or DC braking (DC injection) status. This bit turns ON even for DC braking (DC injection) during reverse run.
- Note 2.** Reverse Operation indicates reverse output status. This bit does not turn ON for DC braking (DC injection).
- Note 3.** Control From Net shows the input status of word n, bit 5 (Net Control) for DeviceNet communications.
- Note 4.** Reference From Net shows the input status of word n, bit 6 (Net Reference) for DeviceNet communications.

● Input Data Details

Word address	m+1															
Bit	15	14	13	12	11	10	9	8	7	6	5	4	3	2	1	0
Signal name	Rotational speed monitor data															
Content	Communications data = Rotational speed monitor x 2 ^a a: Speed scale value of Class 2A, Instance 01, Attribute 16 (Initial value: 0) * The speed scale is assigned to the message function. For instructions on how to change it, refer to <i>Chapter 6 Message Communications</i> . * The unit for the rotational speed monitor is set in n035/o1-03 (frequency reference setting and display units) * Data conversion example: When the speed scale value is "0" and the number of motor poles is set in n035/o1-03], and the read data is 03E8 hex: 03E8 hex → 1,000 → 1,000/2 ⁰ → 1,000 r/min															

Note Under the DeviceNet protocol, the unit for the speed reference is fixed as r/min. The number of motor poles (2 to 39) must be set in parameter n035/o1-03 (frequency reference setting and display units) when using DeviceNet (open network).

5-5 Special Remote I/O Operation

The special remote I/O function is a proprietary OMRON format, not a remote I/O format specified by DeviceNet.

This remote I/O function can be used to read/set all of a 3G3MV, 3G3RV, 3G3PV, or 3G3FV Inverter's parameters and take advantage of all of the Inverter's functions.

5-5-1 Overview of Special Remote I/O

Special remote I/O operations utilize DeviceNet remote I/O, and can directly write to and read from internal Inverter registers. Basically, the register numbers for the various functions shown on this and subsequent pages are specified for writing or reading. Once data has been written, it is retained until it is changed by the next write operation.

■ I/O Format (Allocated Words)

● Outputs (PLC to Inverter)

Instance ID: 100 Decimal (64 Hex)

Byte number		Bit 7	Bit 6	Bit 5	Bit 4	Bit 3	Bit 2	Bit 1	Bit 0
Wd n	Right-most	0	Function code (write/read code)						
	Left-most	1	Register number leftmost byte (register number allocated to each parameter, etc.)						
Wd n+1	Right-most	2	Register number rightmost byte (register number allocated to each parameter, etc.)						
	Left-most	3	Register data leftmost byte (data to write to specified register)						
Wd n+2	Right-most	4	Register data rightmost byte (data to write to specified register)						

● Inputs (Inverter to PLC)

Instance ID: 150 Decimal (96 Hex)

Byte number		Bit 7	Bit 6	Bit 5	Bit 4	Bit 3	Bit 2	Bit 1	Bit 0
Wd m	Right-most	0	Function code (returns transmitted code)						
	Left-most	1	Register number leftmost byte (returns transmitted register number)						
Wd m+1	Right-most	2	Register number rightmost byte (returns transmitted register number)						
	Left-most	3	Register data leftmost byte (returns transmitted data amount or reads data)						
Wd m+2	Right-most	4	Register data rightmost byte (returns transmitted data amount or reads data)						

Note 1. Special remote I/O outputs and inputs are paired. When using special remote I/O, be sure to set them together.

Note 2. Special remote I/O objects do not conform to the AC/DC drive profile, but are specially set for this product.

Note 3. The 16-bit data (register number and register data) is set in two words for each setting.

Note 4. Be careful of the order of the leftmost and rightmost bytes of the 16-bit data. The order is reversed from that of basic and standard remote I/O.

■ Function Codes

The special remote I/O function codes are shown in the following table. Note that they are different from the explicit message service codes.

Function code (hex)	Content
10	Data writing
03	Data reading
00	No execution (data wrapping only; no internal processing takes place.)

■ Setting Data for Operations and Parameters

Read data and write data to be set for operations and parameters are calculated as shown below and then transmitted in hexadecimal.

- Convert to hexadecimal values with the operation/parameter minimum setting value as 1.
- Negative numbers are expressed as two's complements.
- If the original data is already displayed in hexadecimal, it is transmitted as is.
- Set bits that are not used to "0."
- Do not perform data settings for unused registers.

Example 1: Setting a frequency reference of 60 Hz when the minimum setting unit is 0.01 Hz.:
 $60/0.01 = 6000 \rightarrow 1770$ hex

Example 2 (for 3G3RV/3G3PV/3G3FV Inverters): Setting a frequency reference bias (voltage, terminal 13) of -50% when the minimum setting unit is 0.1%:
 $50/0.1 = 500 \rightarrow 01F4$ hex

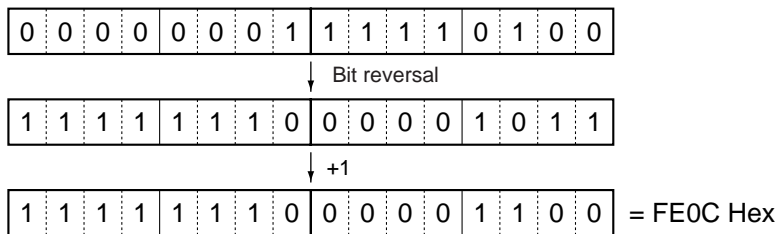

Example 3: Setting a value of 1F hex in the multi-function input:
 Send the value 1F hex.

■ Enabling Parameter Settings with the ENTER Command

Always send an ENTER command when setting (writing) data in parameters. New data written to the parameters will be enabled as operating data after the Inverter receives the ENTER command. (In the 3G3MV, the new settings will be enabled after the parameters are received.)

When two or more parameters are being set (written), send the ENTER command just one time after all of the parameters have been set. All of the parameters that have been set will be enabled when the ENTER command is sent.

Command	Send format	Inverter operation	Remarks
ENTER command that writes parameters to EEPROM	Function code: 10 hex Register number: FFFD hex Send data: 0000 hex	When the ENTER command is received, the last string of parameter settings data that was received is stored in EEPROM and enabled as operating data. (EEPROM can be overwritten up to 100,000 times.)	Supported by all Inverter software. Use this command when you want the data to be retained even after the power is turned OFF.
ENTER command that does not write parameters to EEPROM	Function code: 10 hex Register number: FFDD hex Send data: 0000 hex	When the ENTER command is received, the last string of parameter settings data that was received is enabled as operating data but it is not stored in EEPROM. When the power is turned OFF, the settings data is cleared and returned to the original values.	Supported by all Inverter software. With the 3G3MV, the settings data is enabled immediately after it is received, so it is not necessary to send an ENTER command.

Note 1. In Inverters other than the 3G3MV, the parameter data will not be enabled unless the ENTER command is sent. In some cases, it will not be possible to start the Inverter.

Note 2. The ENTER command is required for the parameters (register numbers 0100 and higher). Values such as the run command and frequency reference (register numbers 0000 to 000F) are stored in the RAM area only, so that data is enabled without an ENTER command.

■ Special Remote I/O Responses

When data is written and read using special remote I/O, the responses shown in the following table are returned. Check that the input data and output data match when handling communications.

Fault code	Name	Content	Countermeasure
---	Normal completion response	The function code and register number at the time of transmission are placed at the beginning, and returned with the data amount (when data is written) or the read data (when data is read) attached.	---
01 hex	Function code error	A code other than 03 hex/08 hex/10 hex has been set as a function code.	Check and correct the function code.
02 hex	Register number error	The specified register number has not been registered. An attempt was made to read an ENTER command register.	Check and correct the register number.
21 hex	Data setting error	An upper or lower limit for the write data setting range was exceeded. Invalid data has been set that would cause an operation error (OPE1 to OPE9).	Check the display for the Digital Operator and correct the invalid data.

Fault code	Name	Content	Countermeasure
22 hex	Writing mode error	during Inverter operations, a write-request message was received for a parameter that is read-only during operation.	Perform write operations after stopping the Inverter.
		An ENTER command was received during Inverter operations.	
		A read-requested message was received during UV detection.	Perform write operations after clearing the UV (main circuit undervoltage) error.
		An ENTER command was received during UV detection.	
		during F04 (initial memory error) detection, a write-request message other than constant initialization, was received.	After constant initialization has been performed, turn the power supply OFF and ON again.
		A write-request message was received for a read-only register.	Check and correct the register number.

Note When a communications error occurs, the MSB (most significant bit) of the function code will be set to “1” in the response.

5-5-2 Special Remote I/O Communications Timing

With special remote I/O communications, it is possible to use all of the SYSDRIVE 3G3MV/3G3RV/3G3FV functions, such as frequency setting, control input setting, error monitoring, output frequency monitoring, and so on. These functions are utilized by setting the register numbers and connecting to the various Inverter functions. To use these functions properly, be sure to use the following method to handle the data and provide a program for switching the communications processing.

■ Matching Function Codes and Register Numbers

- In the remote I/O outputs (PLC to Inverter), set the function code, register number, and set data for the function to be executed.
- Compare (CMP) the function codes and register numbers of the set remote I/O outputs and the remote I/O inputs (Inverter to PLC). If they agree, proceed to the next process.

Note If data is repeatedly written to the same register number, it cannot be handled. Be sure to keep performing processes with different function codes or register numbers. If it is necessary to write repeatedly to the same register number, then alternately write to and read from that register. (Handling data is made possible by changing function codes.)

■ Handling Illustration

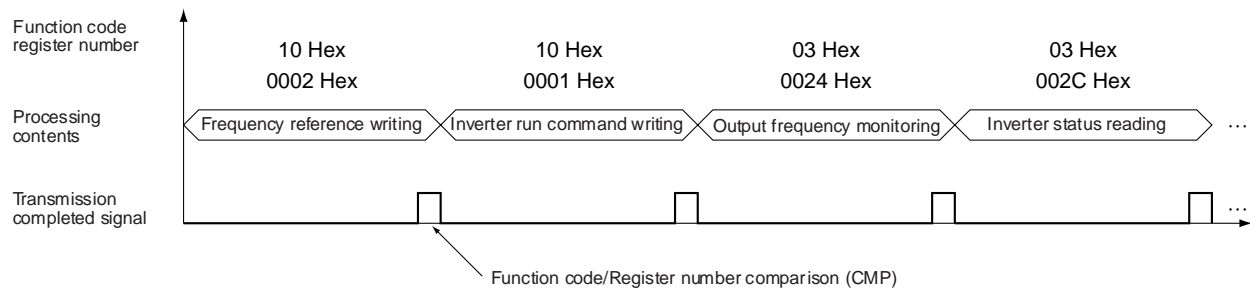

5-5-3 Parameter Register Numbers for Each Function

Refer to the following sections for tables showing each Inverter's functions and the parameter register numbers.

- 3G3MV: 10-4 3G3MV Register Numbers, Classes, Instances, and Attributes.
- 3G3RV: 10-5 3G3RV Register Numbers, Classes, Instances, and Attributes.
- 3G3FV: 10-7 3G3FV Register Numbers, Classes, Instances, and Attributes.

5-6 Control Remote I/O Operation

The control I/O remote I/O function is a proprietary OMRON format, not a remote I/O format specified by DeviceNet.

This remote I/O function's features and arrangement match the control terminal I/O signals of the 3G3MV/3G3RV/3G3PV/3G3FV Inverters, so it can be used for communications with the Inverter's multi-function inputs. There are also default settings available in which the Unit status (16 bits) or multi-function input monitor data (8 bits) is attached to this remote I/O function for allocation in the Master (data connection path setting).

5-6-1 Control I/O Remote I/O Operation

■ I/O Format (Allocated Words)

● Outputs (PLC to Inverter)

Instance ID: 101 Decimal (65 Hex)

SYSDRIVE 3G3MV Inverters

Byte number			Bit 7	Bit 6	Bit 5	Bit 4	Bit 3	Bit 2	Bit 1	Bit 0
Wd n	Right-most	0		Multi-function input 7	Multi-function input 6	Multi-function input 5	Multi-function input 4	Multi-function input 3	Reverse/stop	Forward/stop
	Left-most	1	Multi-function output 2	Multi-function output 1	Multi-function contact output				Fault reset	External fault input
Wd n+1	Right-most	2	Frequency reference, rightmost byte							
	Left-most	3	Frequency reference, leftmost byte							
Wd n+2	Right-most	4								
	Left-most	5								
Wd n+3	Right-most	6								
	Left-most	7								

SYSDRIVE 3G3RV/3G3PV/3G3FV Inverters

Byte number		Bit 7	Bit 6	Bit 5	Bit 4	Bit 3	Bit 2	Bit 1	Bit 0	
Wd n	Right-most	0	Multi-function input 6	Multi-function input5	Multi-function input4	Multi-function input3	Multi-function input2	Multi-function input1	Reverse/stop	Forward/stop
	Left-most	1	Multi-function output 2	Multi-function output 1	Multi-function contact output				Fault reset	External fault input
Wd n+1	Right-most	2	Frequency reference, rightmost byte							
	Left-most	3	Frequency reference, leftmost byte							
Wd n+2	Right-most	4	Torque reference/torque limit, rightmost byte							
	Left-most	5	Torque reference/torque limit, leftmost byte							
Wd n+3	Right-most	6	Torque compensation bias, rightmost byte							
	Left-most	7	Torque compensation bias, leftmost byte							

● Inputs (Inverter to PLC)

Instance ID: 151 Decimal (97 Hex)

Byte number		Bit 7	Bit 6	Bit 5	Bit 4	Bit 3	Bit 2	Bit 1	Bit 0	
Wd m	Right-most	0	Fault	Alarm (minor fault)	Inverter ready	At reference	During reset input	During reverse run	Zero speed	During run
	Left-most	1	P lock completion (See note 4.)		Multi-function output 2	Multi-function output 1	Multi-function contact output	Local/remote	Power interruption recovery	Operation fault
Wd m+1	Right-most	2	Output frequency monitor, rightmost byte							
	Left-most	3	Output frequency monitor, leftmost byte							
Wd m+2	Right-most	4	Torque reference monitor, rightmost byte							
	Left-most	5	Torque reference monitor, leftmost byte							
Wd m+3	Right-most	6	Output current monitor, rightmost byte							
	Left-most	7	Output current monitor, leftmost byte							

Note 1. A shaded box indicates that the bit is not used.

Note 2. Control remote I/O inputs and outputs are paired. When using control remote I/O, be sure to set them together.

Note 3. Control remote I/O objects do not conform to the AC/DC drive profile, but are specially set for this product.

Note 4. The P lock function (position lock or zero-servo function) is valid only for a 3G3FV Inverter operating with flux vector control. This bit is not used with other Inverters or control modes.

■ Bit and Data Functions

● Output Bit Details

Name	Function
Forward/stop	0: Stop, 1: Forward
Reverse/stop	0: Stop, 1: Reverse
Multi-function input <input type="checkbox"/>	0: ---, 1: Function set for multi-function input <input type="checkbox"/>
External fault input	0: ---, 1: External fault (EFO) (See note 1.)
Fault reset	0: ---, 1: Reset
Multi-function contact output	0: Turn OFF (open) multi-function contact output. 1: Turn ON (close) multi-function contact output. (See note 2.)
Multi-function output <input type="checkbox"/>	0: Turn OFF (open) multi-function output <input type="checkbox"/> 1: Turn ON (close) multi-function output <input type="checkbox"/> (See note 2.)

Note 1. The function set with the multi-function input selection parameters can be used by operating multi-function input .

3G3MV: The functions set in n052 to n056 (function selection for multi-function inputs 3 to 7) can be used.

3G3RV/3G3PV:

The functions set in H1-01 to H1-05 (function selection for multi-function inputs 1 to 5) can be used. (Multi-function input 6 is not used.)

3G3FV: The functions set in H1-01 to H1-06 (function selection for multi-function inputs 1 to 6) can be used.

Note 2. The multi-function contact output and multi-function output will be enabled when the following parameters are set, so that the outputs in the Inverter's control terminals can be controlled from communications.

3G3MV: Enabled when parameters n057 to n059 (function selection for multi-function outputs 1 to 3) are set to 18 (12 hex) to specify communications output.

3G3RV/3G3PV/3G3FV:

Enabled when parameters H2-01 to H2-03 (function selection for the multi-function contact output and multi-function outputs 1 and 2) are set to F (not used).

● Output Data Details

Word	Signal name	Content
n+1	Frequency reference (3G3MV/3G3RV/3G3PV/3G3FV)	<p>Specifies the Inverter output frequency from communications.</p> <ul style="list-style-type: none"> Setting unit: 0.01 Hz (See note 2.) Setting range: 0 to maximum frequency in Hz (See note 3.) <p>Example: To set the frequency reference to 60.00 Hz: $60.00 \text{ Hz} / (0.01 \text{ Hz}) = 6000 \text{ decimal} = 1770 \text{ hex} \rightarrow \text{Set as } 1770 \text{ hex.}$</p>
n+2	Torque reference/torque limit (3G3FV)	<p>Specifies the torque reference or torque limit for the Inverter output. (See notes 4 and 5.) The torque limit/torque reference is only enabled when flux vector control is set.</p> <ul style="list-style-type: none"> Whether torque reference or torque limit is specified depends on the Inverter's control mode. Speed control: torque limit Torque control: torque reference Setting unit: 0.1% (100% = motor rated torque) Setting range: -300.0% to 300.0% (See note 6.) <p>Example: To set the torque reference to 10%: $10\% / (0.1\%) = 100 \text{ decimal} = 64 \text{ hex} \rightarrow \text{Set as } 64 \text{ hex.}$</p>
n+3	Torque compensation bias (3G3FV)	<p>Specifies the torque compensation bias when using torque control. (See note 4.) Torque compensation bias is only available when performing torque control in flux vector control mode. It is used separately from torque control to compensate for mechanical torque loss.</p> <ul style="list-style-type: none"> Setting unit: 0.1% (100% = motor rated torque) Setting range: -300.0% to 300.0% (See note 6.) <p>Example: To set the torque compensation bias to 100%: $100.0\% / (0.1\%) = 1000 \text{ decimal} = 3E8 \text{ hex} \rightarrow \text{Set as } 3E8 \text{ hex.}$</p>

Note 1. In this manual, the parameter location for the 3G3MV is written ahead of the parameter location for the 3G3RV/3G3PV/3G3FV, so “n035/o1-03” indicates a parameter location of n035 for the 3G3MV and parameter location of o1-03 for the 3G3RV/3G3PV/3G3FV.

Note 2. The data setting unit can be changed with n35/o1-03 (frequency reference setting/display unit).

Note 3. Data that exceeds the upper or lower setting range limits will be considered faulty and ignored by the Inverter, and the previous data will be maintained.

Note 4. This function is only available with 3G3FV Inverters, which are equipped with flux vector control mode. It cannot be used with the 3G3MV/3G3RV/3G3PV Inverters.

Note 5. When not using either the torque limit of the torque reference, set F9-05 (torque reference/torque limit selection from communications) to 0 (disabled). If this setting is not disabled and “0” is sent as data, the torque limit/torque reference will be set to 0, and there will be no torque output (i.e., the motor will not operate).

Note 6. Although the setting range for torque reference/torque limit is -300.0% to 300.0%, the torque actually output depends on the motor characteristics. For a general-purpose motor, take the range to be -200.0% to 200.0%.

● Input Bit Details

Name	Function
During run	1: During run
Zero speed	1: Zero speed
During reverse run	1: During reverse run
During reset input	1: During reset input
At reference	1: At reference
Inverter ready	1: Inverter ready
Alarm (minor fault)	1: Alarm (minor fault)
Fault	1: Fault
Operation fault	1: Operation fault
Power interruption recovery	1: Recovered from a momentary power interruption
Local/remote	1: Remote mode
Multi-function contact output	1: Function specified in n057/H2-01 (See note 1.)
Multi-function output 1	1: Function specified in n058/H2-02 (See note 1.)
Multi-function output 2	1: Function specified in n059/H2-03 (See note 1.)
P lock completion	1: Position lock engaged (See note 2.)

Note 1. The function set in the multi-function output selection parameter is enabled.

3G3MV: The function set in parameter n057 to n059 (function selection for multi-function outputs 1 to 3) is enabled.

3G3RV/3G3PV/3G3FV:

The function set in parameter H2-01 to H2-03 (function selection for the multi-function contact output and multi-function outputs 1 and 2) is enabled.

Note 2. The P lock function (position lock or zero-servo function) is valid only for a 3G3FV Inverter operating with flux vector control. This bit is not used with other Inverters or control modes.

● Input Data Details

Word	Signal name	Content
m+1	Output frequency monitor (3G3MV/3G3RV/3G3PV/ 3G3FV)	Gives the frequency being output by the Inverter. <ul style="list-style-type: none"> • Monitor unit: 0.01 Hz (See note 1.) Example: Output frequency when the monitor value is 1388 hex: 1388 hex = 5000 decimal \times (0.01 Hz) = 50.00 Hz
m+2	Torque reference monitor (3G3MV/3G3RV/3G3PV/ 3G3FV)	Gives the torque reference value inside the Inverter (See note 2.) <ul style="list-style-type: none"> • Monitor unit: 0.1% (100% is motor rated torque) Example: Torque reference for monitor value of 1F4 hex: 1F4 hex = 500 decimal \times (0.1%) = 50% (relative to motor rated torque)
m+3	Output current monitor (3G3MV/3G3RV/3G3PV/ 3G3FV)	Gives the value of the current being output by the Inverter <ul style="list-style-type: none"> • 3G3MV Monitoring units: 0.01 A (when the content of n179 is 0027 or higher) 0.1 A (when the content of n179 is 0026 or lower) • 3G3RV/3G3FV Monitoring units: 0.01 A (for Inverters with maximum motor capacity of 7.5 kW max.) 0.1 A (for Inverters with maximum motor capacity of 11 kW min.) Example: Output current for 0.4-kW 3G3RV Inverter with monitor value of C8 hex: C8 hex = 200 decimal \times (0.01 A) = 2.00 A

Note 1. The data setting units can be changed in parameter n35/o1-03 (frequency reference setting/display unit).

Note 2. The torque reference monitor is valid only if open-loop vector control (sensor-less vector control) or flux vector control is set.

5-6-2 Control I/O Remote I/O + Multi-function Input Monitor

This remote I/O setting attaches the 8-bit multi-function input monitor data to the control I/O remote I/O function described in 5-6-1 *Control I/O Remote I/O Operation*.

The multi-function input monitor allows the ON/OFF status of the Inverter's control input terminals to be monitored at the Master. For example, if a particular multi-function input terminal is set to "Not used" in the parameters, a sensor or other input device can be connected to that terminal and the signal can be used in the PLC's ladder program.

Note The bits in the multi-function input monitor will be turned ON not only when the terminal's signal is ON, but also when the corresponding bit is turned ON from remote I/O. (The terminal's ON/OFF status is logically ORed with the status of the bit sent through remote I/O.)

■ I/O Format (Allocated Words)

● Outputs (PLC to Inverter)

Instance ID: 101 Decimal (65 Hex)

SYSDRIVE 3G3MV

Byte number		Bit 7	Bit 6	Bit 5	Bit 4	Bit 3	Bit 2	Bit 1	Bit 0	
Wd n	Right-most	0		Multi-function input 7	Multi-function input 6	Multi-function input 5	Multi-function input 4	Multi-function input 3	Reverse/stop	Forward/stop
	Left-most	1	Multi-function output 2	Multi-function output 1	Multi-function contact output				Fault reset	External fault input
Wd n+1	Right-most	2	Frequency reference, rightmost byte							
	Left-most	3	Frequency reference, leftmost byte							
Wd n+2	Right-most	4								
	Left-most	5								
Wd n+3	Right-most	6								
	Left-most	7								

SYSDRIVE 3G3RV/3G3PV/3G3FV

Byte number		Bit 7	Bit 6	Bit 5	Bit 4	Bit 3	Bit 2	Bit 1	Bit 0	
Wd n	Right-most	0	Multi-function input 6	Multi-function input 5	Multi-function input 4	Multi-function input 3	Multi-function input 2	Multi-function input 1	Reverse/stop	Forward/stop
	Left-most	1	Multi-function output 2	Multi-function output 1	Multi-function contact output				Fault reset	External fault input
Wd n+1	Right-most	2	Frequency reference, rightmost byte							
	Left-most	3	Frequency reference, leftmost byte							
Wd n+2	Right-most	4	Torque reference/torque limit, rightmost byte							
	Left-most	5	Torque reference/torque limit, leftmost byte							
Wd n+3	Right-most	6	Torque compensation bias, rightmost byte							
	Left-most	7	Torque compensation bias, leftmost byte							

● Inputs (Inverter to PLC)

Instance ID: 153 Decimal (99 Hex)

Byte number		Bit 7	Bit 6	Bit 5	Bit 4	Bit 3	Bit 2	Bit 1	Bit 0	
Wd m	Right-most	0	Fault	Alarm (minor fault)	Inverter ready	At reference	During reset input	During reverse run	Zero speed	During run
	Left-most	1	P lock/completion (See note 4.)		Multi-function output 2	Multi-function output 1	Multi-function contact output	Local/remote	Power interruption recovery	Operation fault
Wd m+1	Right-most	2	Output frequency monitor, rightmost byte							
	Left-most	3	Output frequency monitor, leftmost byte							
Wd m+2	Right-most	4	Torque reference monitor, rightmost byte							
	Left-most	5	Torque reference monitor, leftmost byte							
Wd m+3	Right-most	6	Output current monitor, rightmost byte							
	Left-most	7	Output current monitor, leftmost byte							
Wd m+4	Right-most	8	Input 7	Input 6	Input 5	Input 4	Input 3	Input 2	Input 1	Input 0

Note 1. A shaded box indicates that the bit is not used.

Note 2. Control remote I/O inputs and outputs are paired. When using control remote I/O, be sure to set them together.

Note 3. Control remote I/O objects do not conform to the AC/DC drive profile, but are specially set for this product.

Note 4. The P lock function (position lock or zero-servo function) is valid only for a 3G3FV Inverter operating with flux vector control. This bit is not used with other Inverters or control modes.

Note 5. The output words (PLC to Inverter) allocated for the “control I/O remote I/O + multi-function input monitor” function are the same as the output words allocated for the regular control I/O remote I/O function. Just one byte is added to the allocated input words (Inverter to PLC).

■ Bit and Data Functions

The functions of all allocated output bits and data (PLC to Inverter) as well as input bits and data (Inverter to PLC) in input words m through m+3 are the same as the regular control I/O remote I/O function. Refer to 5-6-1 Control I/O Remote I/O Operation for details on these functions.

Only the functions of the inputs in input word m+4 are different, so those functions are described here.

● Input Bit Details (Inputs 0 to 7)

Name	Function		
	3G3MV	3G3RV/3G3PV	3G3FV
Input 0	Status of terminal S1 (multi-function input 1) (See note 3.)	Status of terminal S1 (Forward/Stop)	Status of terminal 1 (Forward/Stop)
Input 1	Status of terminal S2 (multi-function input 2) (See note 3.)	Status of terminal S2 (Reverse/Stop)	Status of terminal 2 (Reverse/Stop)
Input 2	Status of terminal S3 (multi-function input 3)	Status of terminal S3 (multi-function input 1 selection)	Status of terminal 3 (multi-function contact input 1)
Input 3	Status of terminal S4 (multi-function input 4)	Status of terminal S4 (multi-function input 2 selection)	Status of terminal 4 (multi-function contact input 2)
Input 4	Status of terminal S5 (multi-function input 5)	Status of terminal S5 (multi-function input 3 selection)	Status of terminal 5 (multi-function contact input 3)
Input 5	Status of terminal S6 (multi-function input 6)	Status of terminal S6 (multi-function input 4 selection)	Status of terminal 6 (multi-function contact input 4)
Input 6	Status of terminal S7 (multi-function input 7)	Status of terminal S7 (multi-function input 5 selection)	Status of terminal 7 (multi-function contact input 5)
Input 7			Status of terminal 8 (multi-function contact input 6)

Note 1. A shaded box indicates that the bit is not used.

Note 2. The bits in the multi-function input monitor will be turned ON not only when the terminal's signal is ON, but also when the corresponding bit is turned ON from remote I/O. (The terminal's ON/OFF status is logically ORed with the status of the bit sent through remote I/O.)

Note 3. Setting n50 to n56 to 27 to 33 enables using the terminals for sending notification to the PLC.

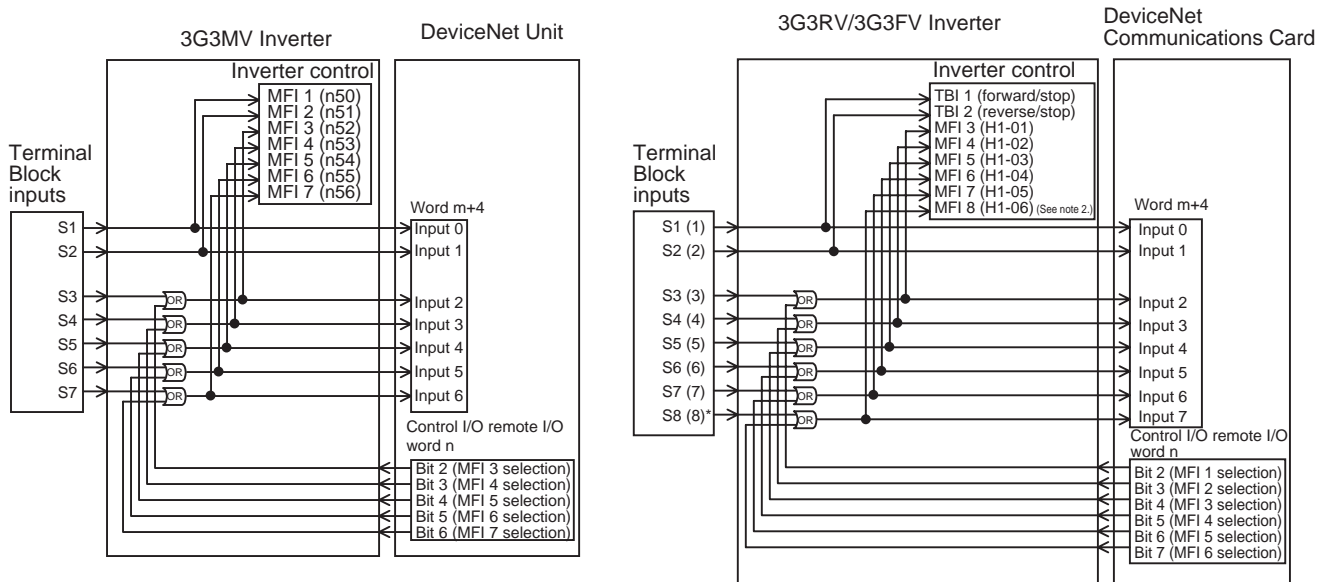

Note 1: MFI = Multifunction input, TBI = Terminal Block input
 Note 2: 3G3FV only

Reference

The multi-function input monitor can be set together with the control I/O remote I/O function as a default connection path in the Slave (Instance ID: 153 decimal (99 hex)). In addition, when a CS/CJ-series DeviceNet (Master) Unit is being used, the multi-function input monitor can be used with other remote I/O functions by allocating the following Instance to a COS connection.

Instance ID: 155 Decimal (9B Hex)

Byte number			Bit 7	Bit 6	Bit 5	Bit 4	Bit 3	Bit 2	Bit 1	Bit 0
Wd M	Right-most	0	Input 7	Input 6	Input 5	Input 4	Input 3	Input 2	Input 1	Input 0

5-7 Unit Status

This section explains the Unit status information, which is allocated in the Master when remote I/O communications are used and can be used to easily monitor the Unit's status. Refer to 5-2 *Switching the Remote I/O Function* for details on allocating unit status to the Master. Refer to 7-2 *Smart Slave Functions* for details on making settings such as each functions threshold value.

Note When using the control I/O remote I/o function, there is a default setting available (a default connection path setting), which attaches the unit status (16 bits) to the remote I/O.

5-7-1 Unit Status

This section explains the I/O format (allocated words) and bit/data functions when the unit status is allocated to a COS connection.

■ I/O Format (Allocated Words)

● Inputs (Inverter to PLC)

Instance ID: 154 Decimal (9A Hex)

Byte number		Bit 7	Bit 6	Bit 5	Bit 4	Bit 3	Bit 2	Bit 1	Bit 0
Wd M	Right-most	0	Connected component maintenance flag	Operation time over flag	Warning torque detected flag	Cooling fan/electrolytic capacitor maintenance flag	Inverter unit maintenance flag	Network power voltage drop flag	
	Left-most	1	Error flag	Inverter detected fault code					

Note 1. A shaded box indicates that the bit is not used.

Note 2. Outputs (PLC to Inverter) cannot be allocated.

■ Bit and Data Details

● Input Bit Details

Name	Function	
Network power voltage drop flag	0: Normal	The network power supply voltage is higher than the preset threshold voltage (present value > threshold value).
	1: Fault	The network power supply voltage is less than or equal to the preset threshold voltage (present value ≤ threshold value).
Inverter unit maintenance flag	0: Normal	The Inverter's operating time is less than the preset threshold voltage (operating time < threshold value).
	1: Fault	The Inverter's operating time is greater than or equal to the preset threshold voltage (operating time ≥ threshold value).
Cooling fan/electrolytic capacitor maintenance flag	0: Normal	The operating time of either the fan or the electrolytic capacitor is less than the preset threshold voltage (operating time < threshold value).
	1: Fault	The operating time of either the fan or the electrolytic capacitor is greater than or equal to the preset threshold voltage (operating time ≥ threshold value).
Warning torque detected flag	0: Normal	The output torque is less than the preset threshold voltage (output current < threshold value).
	1: Fault	The output torque is greater than or equal to the preset threshold voltage (output current ≥ threshold value).
Operation time over flag	0: Normal	The operating time is less than the preset threshold voltage (operating time < threshold value).
	1: Fault	The operating time is greater than or equal to the preset threshold voltage (operating time ≥ threshold value).
Connected component maintenance flag	0: Normal	The value monitored by the "cumulative ON time monitor function" or "number of contact operations monitor function" is less than the preset threshold voltage (maintenance counter < threshold value).
	1: Fault	The value monitored by the "cumulative ON time monitor function" or "number of contact operations monitor function" is greater than or equal to the preset threshold voltage (maintenance counter ≥ threshold value).
Error flag	0: Normal	A fault is not detected in the Inverter.
	1: Fault	A fault was detected in the Inverter. (This flag operates together with the Inverter detected fault code.)

● Input Data Details (Inverter Detected Fault Code)

When a fault has occurred in the Inverter, the fault code will be reported in bits 0 to 6 of the leftmost byte. At the same time, the error flag will be turned ON.

The following table lists the fault codes and corresponding faults.

Fault code (hex)	Applicable Inverters			Operator display	Meaning
	3G3MV	3G3RV 3G3PV	3G3FV		
00	Yes	Yes	Yes		Inverter normal
01	---	Yes	Yes	PUF	Fuse open
02	Yes	Yes	Yes	UV1	Undervoltage (main)
03	Yes	Yes	Yes	UV2	Control power supply fault
04	---	Yes	Yes	UV3	Undervoltage (MC failure in the 3G3RV)
05	Yes	---	Yes	SC	Short circuit

Fault code (hex)	Applicable Inverters			Operator display	Meaning
	3G3MV	3G3RV 3G3PV	3G3FV		
06	Yes	Yes	Yes	GF	Ground fault
07	Yes	Yes	Yes	OC	Overcurrent
08	Yes	Yes	Yes	OV	Main circuit overvoltage
09	Yes	Yes	Yes	OH	Overheat (Inverter overheating for 3G3MV/3G3RV)
0A	---	Yes	Yes	OH1	Overheat (Inverter overheating for 3G3RV)
0B	Yes	Yes	Yes	OL1	Motor overload
0C	Yes	Yes	Yes	OL2	Inverter overload
0D	Yes	Yes	Yes	OL3	Overtorque detection 1
0E	---	Yes	Yes	OL4	Overtorque detection 2
0F	---	Yes	Yes	RR	Braking transistor failure
10	Yes	Yes	Yes	RH	Braking resistor overheating
11	Yes	Yes	Yes	EF3	External fault (Terminal 3)
12	Yes	Yes	Yes	EF4	External fault (Terminal 4)
13	Yes	Yes	Yes	EF5	External fault (Terminal 5)
14	Yes	Yes	Yes	EF6	External fault (Terminal 6)
15	Yes	Yes	Yes	EF7	External fault (Terminal 7)
16	---	---	Yes	EF8	External fault (Terminal 8)
17	---	---	Yes	FAN	Cooling fan faulty
18	---	Yes	Yes	OS	Overspeed
19	---	Yes	Yes	DEV	Speed deviation
1A	---	Yes	Yes	PGO	PG is disconnected
1B	Yes	Yes	Yes	PF	Main circuit voltage error
1C	Yes	Yes	Yes	LF	Output phase loss
1D	---	Yes	---	OH3	Motor overheat 1
1E	Yes	Yes	Yes	OPR	Operator disconnection
1F	---	Yes	Yes	ERR	EEPROM write failure
20	---	Yes	---	OH4	Motor overheat 2
21	Yes	Yes	Yes	CE	RS-422A/RS-485 communications error
22	Yes	Yes	Yes	BUS	Communications error
25	---	Yes	Yes	CF	Control fault
26	---	---	Yes	SVE	Zero servo error
27	Yes	Yes	Yes	EFO	External fault
28	Yes	Yes	Yes	FBL	PID feedback reference lost
29	Yes	Yes	---	UL3	Undertorque detection 1
2A	---	Yes	---	UL4	Undertorque detection 2
2B	---	Yes	---	OL7	Overload during HSB
Variable	Yes	Yes	Yes	CPF□□	Hardware error

Note A “Yes” in the Applicable Inverters column indicates that the Inverter supports the corresponding function; a “---” in the column indicates that the Inverter does not support the function.

5-7-2 Control I/O Remote I/O + Unit Status

This remote I/O setting is a default connection path setting, which attaches the 16-bit Unit status data to the control I/O remote I/O function described in 5-6-1 Control I/O Remote I/O Operation. This section explains the I/O format when the unit status is attached to the control I/O remote I/O.

For details on the function of specific input and output bits/bytes, refer to 5-6-1 Control I/O Remote I/O Operation or 5-7-1 Unit Status.

■ I/O Format (Allocated Words)

● Outputs (PLC to Inverter)

Instance ID: 101 Decimal (65 Hex)

SYSDRIVE 3G3MV

Byte number		Bit 7	Bit 6	Bit 5	Bit 4	Bit 3	Bit 2	Bit 1	Bit 0	
Wd n	Right-most	0		Multi-function input 7	Multi-function input 6	Multi-function input 5	Multi-function input 4	Multi-function input 3	Reverse/stop	Forward/stop
	Left-most	1	Multi-function output 2	Multi-function output 1	Multi-function contact output				Fault reset	External fault input
Wd n+1	Right-most	2	Frequency reference, rightmost byte							
	Left-most	3	Frequency reference, leftmost byte							
Wd n+2	Right-most	4								
	Left-most	5								
Wd n+3	Right-most	6								
	Left-most	7								

SYSDRIVE 3G3RV/3G3PV/3G3FV

Byte number		Bit 7	Bit 6	Bit 5	Bit 4	Bit 3	Bit 2	Bit 1	Bit 0	
Wd n	Right-most	0	Multi-function input 6	Multi-function input 5	Multi-function input 4	Multi-function input 3	Multi-function input 2	Multi-function input 1	Reverse/stop	Forward/stop
	Left-most	1	Multi-function output 2	Multi-function output 1	Multi-function contact output				Fault reset	External fault input

Byte number		Bit 7	Bit 6	Bit 5	Bit 4	Bit 3	Bit 2	Bit 1	Bit 0
Wd n+1	Right-most	2	Frequency reference, rightmost byte						
	Left-most	3	Frequency reference, leftmost byte						
Wd n+2	Right-most	4	Torque reference/torque limit, rightmost byte						
	Left-most	5	Torque reference/torque limit, leftmost byte						
Wd n+3	Right-most	6	Torque compensation bias, rightmost byte						
	Left-most	7	Torque compensation bias, leftmost byte						

● Inputs (Inverter to PLC)

Instance ID: 152 Decimal (98 Hex)

Byte number		Bit 7	Bit 6	Bit 5	Bit 4	Bit 3	Bit 2	Bit 1	Bit 0	
Wd m	Right-most	0	Fault	Alarm (minor fault)	Inverter ready	At reference	During reset input	During reverse run	Zero speed	During run
	Left-most	1	Lock/completion (See note 4.)		Multi-function output 2	Multi-function output 1	Multi-function contact output	Local/remote	UV detected	Operation fault
Wd m+1	Right-most	2	Output frequency monitor, rightmost byte							
	Left-most	3	Output frequency monitor, leftmost byte							
Wd m+2	Right-most	4	Torque reference monitor, rightmost byte							
	Left-most	5	Torque reference monitor, leftmost byte							
Wd m+3	Right-most	6	Output current monitor, rightmost byte							
	Left-most	7	Output current monitor, leftmost byte							
Wd m+4	Right-most	0	Connected component maintenance flag	Operation time over flag	Warning torque detected flag	Cooling fan/electrolytic capacitor maintenance flag	Inverter unit maintenance flag	Network power voltage drop flag		
	Left-most	1	Error flag	Inverter detected fault code						

Note 1. A shaded box indicates that the bit is not used.

Note 2. Control remote I/O inputs and outputs are paired. When using control remote I/O, be sure to set them together.

Note 3. Control remote I/O objects do not conform to the AC/DC drive profile, but are specially set for this product.

- Note 4.** The P lock function (position lock or zero-servo function) is valid only for a 3G3FV Inverter operating with flux vector control. This bit is not used with other Inverters or control modes.
- Note 5.** The output words (PLC to Inverter) allocated for the “control I/O remote I/O + Unit status” function are the same as the output words allocated for the regular control I/O remote I/O function. Just one word is added to the allocated input words (Inverter to PLC).

Reference

When a CS/CJ-series DeviceNet (Master) Unit is being used, we recommend allocating the Unit status to a COS connection instead of using the default connection path setting. during normal operation, the status of the flags in the Unit status will not change, so allocation to a COS connection is more efficient. If the Unit status is set in the default connection path, there input data occupies 5 words so the communications speed will be slower.

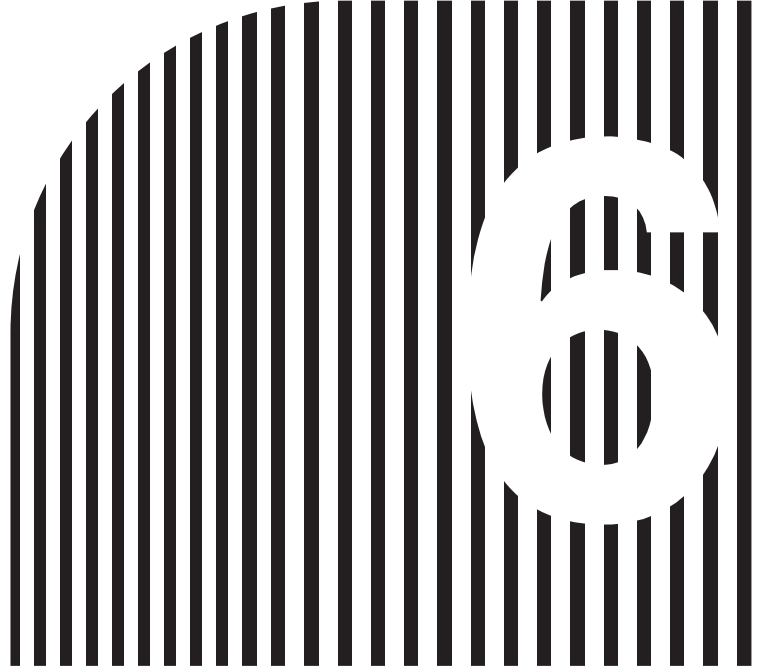

Chapter 6

Message Communications

- 6-1 Overview of Message Communications
- 6-2 Sending Messages from an OMRON PLC
- 6-3 Overview of Messages and Responses
- 6-4 Motor Data Objects: Class 28 Hex
- 6-5 Control Supervisor Objects: Class 29 Hex
- 6-6 AC/DC Drive Objects: Class 2A Hex
- 6-7 Reading and Writing Parameters: Class 64 Hex

6-1 Overview of Message Communications

■ Message Communications Operations

Message communications enable data to be exchanged as required between nodes (i.e., between Masters or between Masters and Slaves) on a DeviceNet Network. For example, the accumulated data from a given PLC can be read from another PLC, and constants from various Slaves can be changed from a PLC. To use message communications, however, both nodes involved in the data exchange must support message communications.

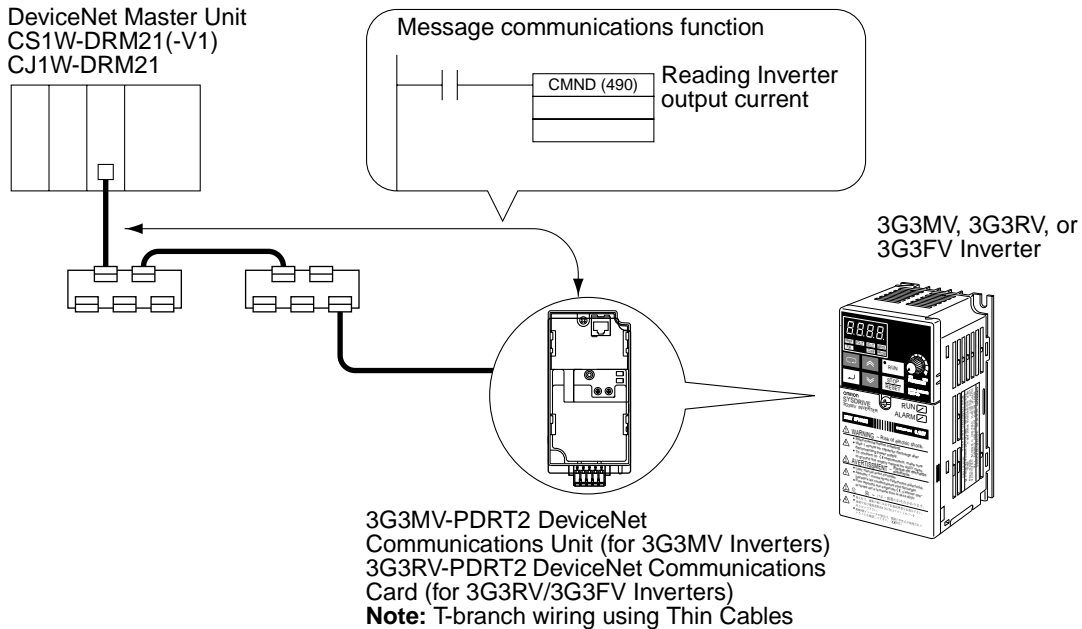

Note When the DeviceNet Communications Unit/Card is used, the RS-422/RS-485 of the Inverter cannot be used for communications.

■ Types of Message Communications

DeviceNet message communications are broadly divided into the two categories described below. Of these two categories, the Inverter's DeviceNet Communications Unit/Card supports explicit messages.

- **Explicit Messages**
Explicit messages are defined by DeviceNet. The class, instance, and attribute are specified for executing message communications. The messages are the same for all Inverter products, so messages can be exchanged in the same way with masters made by other manufacturers.
- **FINS Messages**
Messages can be exchanged using FINS commands between DeviceNet nodes (Masters and Slaves) that support FINS messages. (FINS commands are actually sent and received using DeviceNet explicit messages.)

Note Message communications are supported by CV-series, CS/CJ-series, and C200HX/HG/HE PLCs, but not by C200HS PLCs.

■ Overview of Explicit Messages

Explicit messages are sent and received as described below. Basically explicit message communications are executed in 1-byte (8-bit) units.

Explicit Message Communications Frame

Header	Node address	Service code	Class	Instance	Attribute	Data	Footer
--------	--------------	--------------	-------	----------	-----------	------	--------

Item	Content	
Header	The header indicates the beginning of an explicit message and that the frame is an explicit message request/response. It is set automatically for DeviceNet, so there is no particular need to be concerned with it.	
Node address	Request: Set the node address of the Slave/Master to be requested. Response: The node address of the responding Slave/Master is set.	
Service code	Request: Set the code of the requested service (read/write, etc.). Response: The MSB (most significant bit) of the requested service code is changed to "1" and returned.	
Class	Function classification (major classification)	Indicates the classification of a function defined by DeviceNet. To specify a function, specify these three codes.
Instance	Instance classification (minor classification)	
Attribute	Attribute (Set values are assigned for each function.)	
Data	Request: Set the data to be written. Response: Read-requested data or fault message are attached.	
Footer	This is the part that indicates the end of the explicit message and executes the CRC check. It is set automatically for DeviceNet, so there is no particular need to be concerned with it.	

6-2 Sending Messages from an OMRON PLC

This section explains how to send and receive messages using a CS1W-DRM21(-V1) or CJ1W-DRM21 DeviceNet Unit.

■ Using CMND(490)

With a CS1W-DRM21(-V1) or CJ1W-DRM21 DeviceNet Unit, CMND(490) is used to send explicit messages. To send an explicit message, it is necessary to place FINS command “2801” in front and to send the command to the Master Unit. The Master Unit that receives the command converts the command data to an explicit message and transfers it to the destination node. When sending an explicit message, it is not possible to directly specify the destination node with CMND(490).

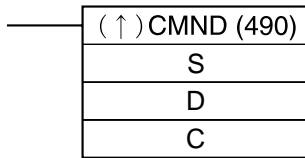

● S: Beginning Command Storage Word

Specify the beginning word address for the command data transferred to the DeviceNet Master Unit. Preset the data to be transferred in consecutive words as shown in the following table.

Word address	Bits	
	15 to 8	7 to 0
S	Command data (Set explicit message FINS command “2801.”)	
S+1	Node of Slave or Master for transmission Address: 0 to 3F hex (0 to 63)	Explicit message service code Write: 10 Read: 0E
S+2	Class ID code (Set DeviceNet class code for relevant function.) Set within 0001 to 002A, 0064, or 0094 to 0097 (hex) with Inverter's DeviceNet Communications Unit.	
S+3	Instance ID code (Set DeviceNet instance code for relevant function.)	
S+4	Attribute ID code (Set DeviceNet attribute code for relevant function.)	Attached data (for writing)
---	Attached data (for writing)	

● D: Beginning Response Storage Word

Specify the beginning word address of the area for storing responses to messages.

● **C: Beginning Control Code Word**

Specify the beginning word address of the area for storing the required control codes for message communications. The control codes shown in the following table are required by DeviceNet Master Units. Preset the data in consecutive words.

Word address	Bits		
	15	14 to 8	7 to 0
C	Number of command data bytes: 0000 to 00A0 hex (0 to 160 bytes) Set the amount of data from the beginning S word.		
C+1	Number of response data bytes: 0000 to 00A0 hex (0 to 160 bytes) Set the size of the data storage area from the beginning D word.		
C+2	Network address: 0000 to 007F hex (0 to 127) (A setting of 0000 hex indicates the local network.) When using CMND(490) with the CS/CJ Series, a network address must be set for each DeviceNet Master Unit. The network address is edited using the routing table edit function of a Peripheral Device (except for the Programming Console).		
C+3	Command destination node address: 00 to 3F hex (0 to 63) Node address of the Master Unit (The local node is specified if C+2 is set to 0000 hex and this byte is set to 00 hex.)	Command destination Unit address Set Master Unit (FE) or Master Unit's unit number, 10 to 1F hex (0 to 15).	
C+4	Response	Communications port number: 0 to 7 Set the communications port used for DeviceNet.	Number of retries: 00 to 0F hex (0 to 15) Set the number of times to resend for error response.
C+5	Response monitor time: 0000 hex → 2 s 0001 to FFFF hex → 0.1 to 6553.5 s (unit: 0.1 s) Set at least 2 seconds for explicit messages.		

Note Set “0” in word C+4 bit 15 to require a response or “1” to not require a response. Responses are required for explicit messages, so set “0.”

■ **Message Timing**

When executing CMND(490), an AND condition must be set that requires both the PLC's Network Communications Enabled Flag and the Master Unit's Message Communications Enabled Flag to be ON.

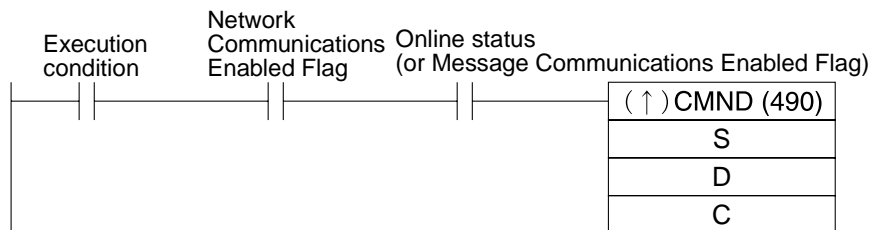

■ **Message Response Read Timing**

Have messages read with the rising edge of the Network Communications Enabled Flag for each communications port.



■ Communications Flags

Type	Name	Address		Content
		Word	Bit	
PLC flags	Network Communications Enabled Flag	A202	7: Port 7 6: Port 6 5: Port 5 4: Port 4 3: Port 3 2: Port 2 1: Port 1 0: Port 0	0: Execution disabled (executing) 1: Execution enabled (not executing)
	Network Communications Error Flag	A219	7: Port 7 6: Port 6 5: Port 5 4: Port 4 3: Port 3 2: Port 2 1: Port 1 0: Port 0	0: Normal end 1: Abnormal end
Master Unit status flags	Online Flag	25 x Unit number + 1511	00	0: Offline 1: Online
	Message Communications Enabled Flag	25 x Unit number + 1524	12	Indicates the same status as the Online Flag. 0: Offline 1: Online This function is compatible with C200HW-DRM21-V1.

6-3 Overview of Messages and Responses

When message communications are used, the Inverter's DeviceNet Communications Unit/Card returns responses as explained below.

Basically, DeviceNet communications are executed in 1-byte (8-bit) units. In the case of single-word data (16 bits), the rightmost bits (least significant) and the leftmost bits (most significant) are reversed in order due to the following reasons:

- Data on communications line is transmitted in the order of rightmost bits and leftmost bits.
- Data that is internally processed by PLC for issuing commands is transmitted in the order of leftmost bits and rightmost bits.

Therefore, reverse the order for attributes where “Word” is written in the “Size” column in the tables on subsequent pages and create attached data or read response data.

Note There is no need to take this into consideration for remote I/O because the rightmost bits and leftmost bits are automatically reversed.

■ Command Format

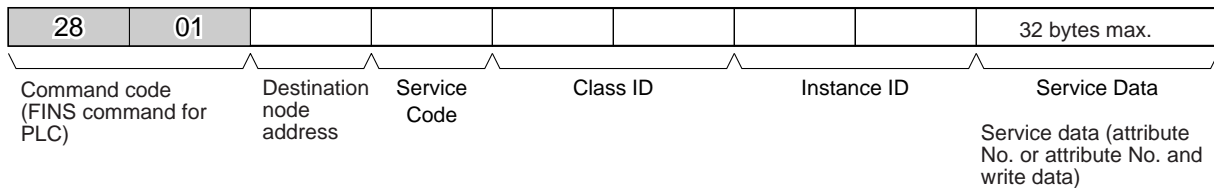

■ Response Format

● Normal Response

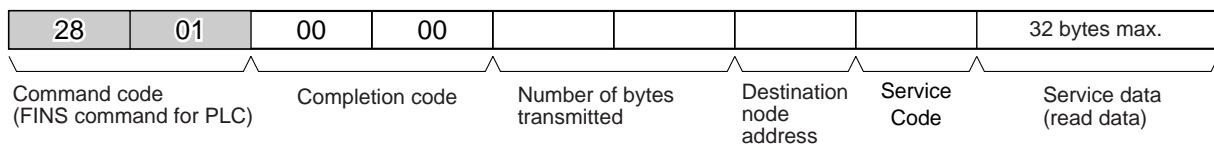

● Error Response

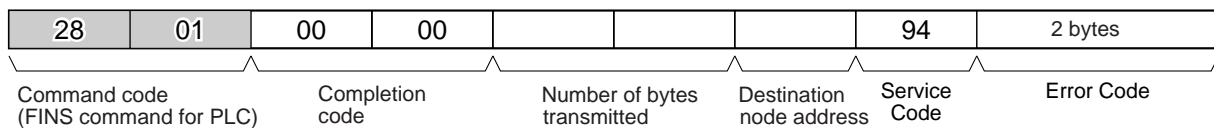

● Failure or Timeout during Transmission

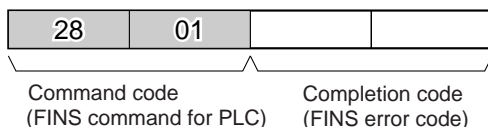

6-4 Motor Data Objects: Class 28 Hex

This section provides details on objects. There are fourteen types of objects:

- Identity objects (identification information): Class 01 hex
- Message router objects: Class 02 hex
- DeviceNet objects: Class 03 hex
- Assembly objects: Class 04 hex
- DeviceNet connection objects: Class 05 hex
- Input terminal control objects: Class 08 hex
- Output terminal control objects: Class 09 hex
- Motor data objects: Class 28 hex
- Control supervisor objects: Class 29 hex
- AC/DC drive objects: Class 2A hex
- Inverter parameter objects: Class 64 hex
- Unit parameter objects: Class 94 hex
- Unit manager objects: Class 95 hex
- Equipment manager objects: Class 97 hex

The three types of objects related to Inverters are the motor data, control supervisor, and AC/DC drive objects. These are explained below and in subsequent sections. For details on the other types of objects, refer to *10-2 Objects*.

Motor data objects are data and functions related to motors connected to Inverters. The motors that can be connected to Inverters are squirrel-cage inductive motors, so the “Motor Type” is always “7.” The motor's rated current and rated voltage can be set and read.

■ Support Service Code

Service code number (hex)	Service
0E	Get attribute single
10	Set attribute single

■ Object Details

Instance	Attribute	Name	Content	Setting range	Default	Read	Write	Size
00	01	Object Software Revision	Indicates class 28 software revisions. The revision value is advanced whenever there is a change.	---	0001	Yes	No	Word
01	03	Motor Type	Indicates the type of motor to be used. The setting for a squirrel-cage inductive motor is 7.	---	07	Yes	No	Byte
	06	Motor Rated Current	The motor's rated current can be set and read. The setting unit is 0.1 A. (The setting unit can be changed using the current scale in Class 2A, Instance 1, Attribute 17.)	Inverter rated output current 10% to 150% (See note 3.)	See note 1.	Yes	Yes	Word
	07	Motor Rated Voltage	The motor's rated voltage can be set and read. The setting unit is 1 V. (The setting unit can be changed using the voltage scale in Class 2A, Instance 1, Attribute 1B.)	0 to 255 V (0 to 510 V) (See note 2.)	00C8 (0190) (See note 2.)	Yes	Yes	Word

Note 1. The default setting for the motor's rated current depends on the Inverter model. Refer to the Inverter's operation manual for details.

Example: 1.90A (0013 hex) for 200-V class, 0.4 kW

Note 2. The figures enclosed in parentheses in the "Setting range" and "Default" columns are the values for 400-V class Inverters.

Note 3. The setting range for the Motor Rated Current is the setting range for the 3G3MV. With the 3G3RV/3G3PV/3G3FV, the setting range is 10% to 120% of the Inverter rated output current.

6-5 Control Supervisor Objects: Class 29 Hex

Control supervisor objects are objects that have Inverter control I/O-related functions. They are assigned according to their particular control I/O functions, such as forward operation, reverse operation, error detection, and so on. Be careful when setting up a remote I/O communications connection. These functions are shared with similar functions used for remote I/O, so even if they have been set for message operations they may get rewritten for remote I/O.

■ Support Service Codes

Service code number (hex)	Service
0E	Get attribute single
10	Set attribute single
05	Reset attribute: Can be sent to Class 29/Instance 01. Turns OFF the Forward Operation and Reverse Operation inputs and turns ON the Fault Reset. Then turns OFF the Fault Reset when Inverter Ready is output.

■ Object Details

Instance	Attribute	Name	Content	Setting range	Default	Read	Write	Size
00	01	Object Software Revision	Indicates class 29 software revisions. The revision value is advanced whenever there is a change.	---	0001	Yes	No	Word
01	03	Forward/Stop	00: Stop 01: Forward operation	00, 01	00	Yes	Yes	Byte
	04	Reverse/Stop	00: Stop 01: Reverse operation	00, 01	00	Yes	Yes	Byte
	05	Net Control Local/remote switch (See note 1.)	00: Operate with setting in n003/b1-02. 01: Operate by DeviceNet (not valid with 3G3FV)	00, 01	00	Yes	Yes	Byte
	06	State Inverter status (See note 1.)	00 hex: Vendor specific 01 hex: Startup 02 hex: Not Ready 03 hex: ready 04 hex: Enabled 05 hex: Stopping 06 hex: Fault_Stop 07 hex: Faulted	---	03	Yes	No	Byte
	07	During forward run	00: No Inverter output or operating in reverse. 01: Forward operation or DC braking (Either DC braking from reverse operation or operating forward.)	---	00	Yes	No	Byte
08	During reverse run	00: No Inverter output or operating in forward. 01: Operating in reverse (reverse operation output status) Becomes "00" with DC braking.	---	00	Yes	No	Byte	

Instance	Attribute	Name	Content	Setting range	Default	Read	Write	Size
01	09	Inverter Ready	00: Preparing Initial processing/ not drive mode/ fault 01: Inverter ready Inverter can receive run command.	---	00	Yes	No	Byte
	0A	Fault	00: Normal 01: Fault	---	00	Yes	No	Byte
	0B	Alarm (minor fault)	00: Normal 01: Alarm (minor fault)	---	00	Yes	No	Byte
	0C	Fault Reset	00: Normal status 01: Fault reset	00, 01	00	Yes	Yes	Byte
	0D	Fault code	Indicates the contents of fault that occur. (See the fault code list on the following page.)	---	0000	Yes	No	Word
	0F	Control From Net Run signal input status (See note 2.)	00: Operating with an n003/b1-02 setting other than DeviceNet. 01: Operating by DeviceNet.	---	00	Yes	No	Byte
	10	DeviceNet Fault mode (See note 3.)	00: Stop operation. 01: Continue operation. 02: Maker's specifications	3G3MV: 00, 01 3G3RV: --- 3G3FV: ---	3G3MV: 00 3G3RV: 02 3G3FV: 02	Yes	Yes	Byte
	11	Force Fault/Trip Communications external fault input	00: Normal operation 01: Communications external fault input	00, 01	00	Yes	Yes	Byte
	12	Force Status Communications external fault input status	00: Normal status 01: Communications external fault detected. (Inverter stopped with fault detection.)	---	00	Yes	No	Byte

Note 1. The following table shows the status of remote I/O output signals and operation indicated by the content of Attribute 06 (State, i.e., Inverter status).

Setting	Status	Condition
00 hex	Vendor specific	A condition other than the ones below.
01 hex	Startup: Preparation not complete (setting constants)	Inverter Ready signal is OFF.
02 hex	Not ready: Stopped (preparation complete)	Inverter Ready signal is ON and During Run signal is OFF.
03 hex	Inverter ready: Stopped (preparation complete)	Inverter Ready signal is ON and During Run signal is OFF.
04 hex	Enabled: Operating	During Run signal (control I/O) is ON.
05 hex	Stopping: Decelerating (Operating with both forward and reverse references equal to 0.)	Ctrl. From Net is ON, During Forward Run is OFF, During Reverse Run is OFF, and During Run is ON.
06 hex	Fault_Stop: Operating with fault detected	Alarm signal is ON.
07 hex	Faulted: Fault detected	Fault signal is ON.

Note 2. The Net Control and Control From Net functions cannot be changed during running.

Note 3. A DeviceNet Fault mode can be set from communications in the 3G3MV only; it cannot be changed from communications in the 3G3RV, 3G3PV, or 3G3FV. Set the fault mode in the Inverter's parameters.

● **Fault Codes**

DeviceNet fault code	Operator display	Meaning
0000	---	Inverter normal
2120	GF	Ground fault
2130	SC	Short circuit
2200	OL2	Inverter overload
2220	OL1	Motor overload
2221	OL3	Overtorque detection 1
2222	OL4	Overtorque detection 2
2300	OC	Overcurrent
3130	PF	Input phase loss
	LF	Output phase loss
3210	OV	Main circuit overvoltage
3220	UV1	Undervoltage (main)
3222	UV3	Undervoltage (MC)
4200	OH	Overheat
4210	OH1	Overheat
5110	UV2	Control power supply fault
5120	PUF	Fuse open
5300	OPR	Operator disconnection
6320	ERR	EEPROM write failure
7110	RR	Braking transistor failure
7112	RH	Braking resistor overheating
7301	PGO	PG is disconnected
7310	OS	Overspeed
	DEV	Speed deviation
7500	BUS	Communications error
9000	EF3	External fault (Terminal 3)
	EF4	External fault (Terminal 4)
	EF5	External fault (Terminal 5)
	EF6	External fault (Terminal 6)
	EF7	External fault (Terminal 7)
	EF8	External fault (Terminal 8)
	FF0	Communications external fault

6-6 AC/DC Drive Objects: Class 2A Hex

AC/DC drive objects are assigned to command-related functions for drive devices such as Inverters and Servomotors. Command-related data reading and writing, monitor data reading, set data scale changes, and so on, are all enabled. These functions are shared with similar functions used for remote I/O, so even if they have been set for message operations they may get rewritten for remote I/O.

■ Support Service Code

Service code number (hex)	Service
0E	Get attribute single
10	Set attribute single

■ Object Details

Instance	Attribute	Name	Content	Setting range	Default	Read	Write	Size
00	01	Object Software Revision	Indicates class 2A software revisions. The revision value is advanced whenever there is a change.	---	0001	Yes	No	Word
01	03	At Reference	00: Stopped, accelerating or decelerating 01: At reference	---	00	Yes	No	Byte
	04	Net Reference (See note 1.)	00: Operate with setting in n004/b1-01. 01: Force DeviceNet operation (not valid in 3G3FV).	00, 01	00	Yes	Yes	Byte
	06	Drive Mode	Set to parameter n002/A1-02. Some Inverters do not support the setting. 00: Open loop vector ([n002/A1-02] = 2) 01: V/f control ([n002/A1-02] = 0) 02: V/f control with PG (A1-02 = 1) 03: Flux vector control (A1-02 = 3) After changing the setting, the power must be turned OFF and then ON again to enable the new setting.	00 to 03	3G3MV: 01 3G3RV: 01 3G3PV: 01 3G3FV: 00	Yes	Yes	Byte

Instance	Attribute	Name	Content	Setting range	Default	Read	Write	Size
01	07	Speed Actual Rotational Speed Monitor (See notes 2 and 4.)	<p>The output frequency monitor (U-02/U1-02) can be monitored in hexadecimal with the minimum unit as 1 hex.</p> <p>The frequency monitor's minimum unit can be set by the frequency reference setting and display units in n035/o1-03.</p> <p>n035/o1-03 = 0: 0.01 Hz n035/o1-03 = 1: 0.01% (100%: Max. frequency.) n035/o1-03 = 2 to 39: 1 r/min n035/o1-03 = 40 to 3,999: Follow individual set values.</p> <p>When r/min units are being used, a multiplier can be set in attribute 16 (the Speed Scale setting).</p>	---	0000	Yes	No	Word
	08	Speed Reference Rotational Speed Reference (See notes 2 and 4.)	<p>Can be set and read in hexadecimal with the frequency reference minimum unit as 1 hex.</p> <p>The frequency reference minimum unit can be set by the frequency reference setting and display units in n035/o1-03.</p> <p>n035/o1-03 = 0: 0.01 Hz n035/o1-03 = 1: 0.01% (100%: Max. frequency.) n035/o1-03 = 2 to 39: 1 r/min n035/o1-03 = 40 to 3,999: Follow individual set values.</p> <p>When r/min units are being used, a multiplier can be set in attribute 16 (the Speed Scale setting).</p>	0 to max. frequency	0000	Yes	Yes	Word
	09	Current Actual	<p>Can be referenced in hexadecimal with the output current monitor U-03/U1-03 minimum unit as 0.1 A.</p> <p>Setting the attribute 17 current scale enables a multiplication factor to be set.</p>	---	0000	Yes	No	Word
	0F	Power Actual	<p>Can be referenced in hexadecimal with the output power monitor U-11/U1-08 minimum unit as 1 W.</p> <p>Setting the attribute 1A power scale enables a multiplication factor to be set.</p>	---	0000	Yes	No	Word

Instance	Attribute	Name	Content	Setting range	Default	Read	Write	Size
01	10	Input Voltage	Can be referenced in hexadecimal with the input voltage setting (200 or 400/E1-01) minimum unit as 1 V. Setting the attribute 1B voltage scale enables a multiplication factor to be set.	---	0000	Yes	No	Word
	11	Output Voltage	Can be referenced in hexadecimal with the output voltage monitor U-04/U1-06 minimum unit as 1 V. Setting the attribute 1B voltage scale enables a multiplication factor to be set.	---	0000	Yes	No	Word
	12	Accel Time	Can be set and read in hexadecimal with the acceleration time 1 n019/C1-01 and deceleration time 1 n020/C1-02 minimum unit as 1 ms. Depending on the acceleration/ deceleration time unit n019/C1-10 setting, numbers below 100 ms or 10 ms are truncated. Setting the attribute 1C time scale enables a multiplication factor to be set.	0.0 to 6,000.0 s (0.00 to 600.00 s)	2710 hex (10.0 s)	Yes	Yes	Word
	13	Decel Time			2710 hex (10.0 s)	Yes	Yes	Word
	14	Low Speed Limit (See notes 2 and 3.)	Can be set and read in hexadecimal with the frequency reference lower limit n034/d2-02 and the frequency reference upper limit n033/d2-01 minimum unit as 1 ms.	0 to 109% of maximum frequency	0000	Yes	Yes	Word
15	High Speed Limit (See notes 2, 3, and 4.)	The minimum unit can be set by the frequency reference setting and display units in n035/o1-03. n035/o1-03 = 0: 0.01 Hz n035/o1-03 = 1: 0.01% (100%: Max. frequency.) n035/o1-03 = 2 to 39: 1 r/min n035/o1-03 = 40 to 3,999: Follow individual set values. When r/min units are being used, a multiplier can be set in attribute 16 (the Speed Scale setting).	0 to 110% of maximum frequency	0708 hex (1,800 r/min)	Yes	Yes	Word	

Instance	Attribute	Name	Content	Setting range	Default	Read	Write	Size
01	16	Speed scale	Speed data unit selection can be set and read. The speed data unit value is calculated as follows: Unit = 1 [r/min] x 1/2 ^a a: Speed scale set value Set a negative value as its 2's complement.	-15 to 15 (F1 to 0F hex)	00	Yes	Yes	Byte
	17	Current scale	Current data unit selection can be set and read. The current data unit value is calculated as follows: Unit = 0.1 [A] x 1/2 ^b b: Current scale set value Set a negative value as its 2's complement.	-15 to 15 (F1 to 0F hex)	00	Yes	Yes	Byte
	1A	Power scale	Power data unit selection can be set and read. The power data unit value is calculated as follows: Unit = 1 [W] x 1/2 ^c c: Power scale set value Set a negative value as its 2's complement.	-15 to 15 (F1 to 0F hex)	00	Yes	Yes	Byte
	1B	Voltage scale	Voltage data unit selection can be set and read. The voltage data unit value is calculated as follows: Unit = 1 [V] x 1/2 ^d d: Voltage scale set value Set a negative value as its 2's complement.	-15 to 15 (F1 to 0F hex)	00	Yes	Yes	Byte
	1C	Time scale	Time data unit selection can be set and read. The time data unit value is calculated as follows: Unit = 1 [ms] x 1/2 ^e e: Voltage scale set value Set a negative value as its 2's complement.	-15 to 15 (F1 to 0F hex)	00	Yes	Yes	Byte
	1D	Reference From Net (See note 1.)	00: Reference other than DeviceNet (n004/b1-01) 01: Operating with DeviceNet.	---	00	Yes	No	Byte
	64	Electric power	Average power value (W)	---	0000 0000	Yes	No	Long
	65	Electric power time scale	Power value measurement period (T) (reflected when power is turned ON) 00: 10 minutes 01: 30 minutes 02: 60 minutes	00 to 02	00	Yes	Yes	Byte
	6F	Specific alarm	Alarm code of the alarm or minor fault detected in the Inverter. For more details, refer to 8-5 <i>Inverter Alarms</i> .	---	0000	Yes	No	Word
	70	Specific error	Fault code of the fault detected in the Inverter. For more details, refer to 8-4 <i>Inverter Faults</i> .	---	00	Yes	No	Byte

- Note 1.** The Net Reference and Reference From Net functions cannot be changed during running.
- Note 2.** Under the DeviceNet protocol, the unit for the speed reference is always r/min. The number of motor poles (2 to 39) must be set in parameter n035/o1-03 (frequency reference setting and display units) when using DeviceNet (open network). After changing the unit setting, turn the power OFF and then ON again.
- Note 3.** Cannot be changed during running.
- Note 4.** If a frequency reference value has been already set and the frequency display unit is changed via the network, a frequency reference value higher than expected may result after unit conversion. After changing the frequency display unit, always check the frequency reference value before starting an operation.

● Communications Data Setting Examples

Example 1: Finding the communications data for outputting a frequency of 60 Hz with the following conditions set.

Number of poles set in n035/o1-03: 4

Speed scale (attribute 16): 0

- Converting frequency to rotational speed:
 $\text{Frequency} \times 120 / \text{number of poles} = 60 \times 120 / 4 = 1,800 \text{ r/min}$
- Converting rotational speed to minimum unit:
 $\text{Rotational speed} / \text{unit} = 1,800 / (1 \text{ r/min} \times 1/2^0) = 1,800$
- Converting communications data to hexadecimal: 1,800 (decimal) = 0708 (hex)

Example 2: Finding the communications data for outputting a frequency of 60 Hz with the following condition set.

Frequency setting in n035/o1-03: 0 (Cannot be set with DeviceNet protocol.)

- Converting frequency to minimum setting unit:
 $\text{Frequency} / \text{minimum unit} = 60 / 0.01 = 6,000$
- Converting communications data to hexadecimal: 6,000 (decimal) = 1,770 (hex)

Example 3: Finding the communications data for setting a one-minute acceleration time with the following condition set.

Time scale (attribute 1C): -3 (FD hex)

- Matching the acceleration time unit: 1 minute = 60 seconds = 60,000 ms
- Converting acceleration time to minimum unit:
 $\text{Acceleration time} / \text{unit} = 60,000 / (1 \text{ ms} \times 1/2^{-3}) = 7,500$
- Converting communications data to hexadecimal: 7,500 (decimal) = 1D4C (hex)

● Communications Data Reference Example

In this example, the hexadecimal value 0BB8 that has been read is converted to frequency with the following conditions set.

Number of poles set in n035/o1-03: 4

Speed scale (attribute 16): 1

- Converting communications data to decimal: 0BB8 (hex) = 3,000 (decimal)
- Converting from minimum unit to r/min:
 $\text{Communications data} \times \text{unit} = 3,000 \times (1 \text{ r/min} \times 1/2^1) = 1,500 \text{ (r/min)}$

6-7 Reading and Writing Parameters: Class 64 Hex

Inverter parameters can be read and written using explicit messages. Class 100 decimal (64 hex) has been provided with instances and attributes corresponding to each parameter in the Inverter. Send an explicit message to the class, instance, or attribute of the parameter to be set as described below.

Parameter Database

All parameters in the parameter database have been unified to 1-word (16-bit) data. Even settings of 0 and 1 will be treated as 1-word (16-bit) data in explicit messages.

Note When sending or receiving 1-word (16-bit) data in an explicit message, the leftmost and rightmost bytes will be reversed. Accordingly, when reading or writing data, the attribute value will be in the upper byte, the lower byte will contain the lower byte of the data, and the upper byte of the data will be in the upper byte of the next word.

- Communications line data is sent and received in the order of lower byte, then upper byte.
- PLC internal processing data, such as when sending commands, are sent and received in the order of upper byte, then lower byte.

Parameter Read and Write Data

Read data and write data for parameters is calculated as shown below and then transmitted in hexadecimal.

- Convert to hexadecimal values with the function/parameter minimum setting unit taken as 1.
Example: To set a frequency reference of 60 Hz when the minimum setting unit is 0.01 Hz.
 $60/0.01 = 6000 \rightarrow 1770$ hex
- Negative numbers are expressed as two's complements. (A 3G3MV is used in this example).
Example: To set a frequency reference bias (n061) of -100% when the minimum setting unit is 1%:
 $100/1 = 100$ decimal = 0064 hex, $-100\% \rightarrow$ FF9C hex

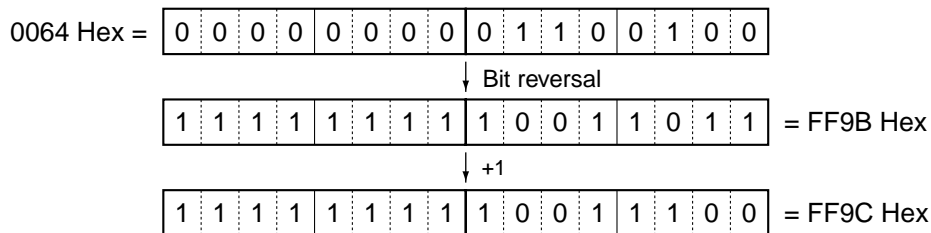

- If the original data is already in hexadecimal, it is transmitted as is.

Note All parameters in the 3G3MV Series are in decimal, so convert them to hexadecimal.

- Set bits that are not used to "0."
- Do not set data for unused registers.

■ Using the ENTER Command

● Storing Parameter Data in a 3G3MV Using the ENTER Command

To store the parameter data received in EEPROM, send an ENTER command as shown in the following table. To store a series of data for more than one parameter, send an ENTER command after completing all the settings.

Data type	Transmission	Inverter Operation	Remarks
ENTER command to write to EEPROM	Write 0000 as the data used by the function (i.e., the ENTER command). Use the following codes: Class: 100 decimal (64 hex) Instance: 255 decimal (FF hex) Attribute: 253 hex (FD hex)	Previously received parameter setting data is stored in EEPROM. Note: The maximum number of write operations that can be performed to EEPROM is 100,000.	Used to store data even after a power interruption.
Not writing to EEPROM	ENTER command not sent.	Previously received parameter setting data is already validated as operating data. Send ENTER command only if storing to EEPROM.	If there is frequent rewriting of data, do not send ENTER commands each time because of the limit to the number of times EEPROM can be written. Be sure to send an ENTER command once before the power supply is interrupted.

● Enabling Parameter Data in a 3G3RV/3G3PV/3G3FV Using the ENTER Command

To enable parameter data that has been received, send an ENTER command as shown in the following table to either store or not store the parameters in EEPROM. To enable a series of data for more than one transmission, send only one ENTER command after sending all of the data.

Data type	Transmission	Inverter Operation	Remarks
ENTER command that writes parameters to EEPROM	Write 0000 as the data used by the function (i.e., the ENTER command). Use the following codes: Class: 100 decimal (64 hex) Instance: 255 decimal (FF hex) Attribute: 253 hex (FD hex)	Previously received parameter setting data is stored in EEPROM. Note: The maximum number of write operations that can be performed to EEPROM is 100,000.	Used to store data even after a power interruption.
ENTER command that does not write parameters to EEPROM	Write 0000 as the data used by the function (i.e., the ENTER command). Use the following codes: Class: 100 decimal (64 hex) Instance: 255 decimal (FF hex) Attribute: 221 hex (DD hex)	Previously received parameter setting data is enabled as operating data without storing it to EEPROM.	If there is frequent rewriting of data, do not send ENTER commands each time because of the limit to the number of times EEPROM can be written. Be sure to send an ENTER command that writes data to EEPROM once before the power supply is interrupted.

■ **Parameter Classes, Instances, and Attributes**

For details on each Inverter's functions and the registers allocated to each parameter, refer to *10-4 3G3MV Register Numbers, Classes, Instances, and Attributes*, *10-5 3G3RV Register Numbers, Classes, Instances, and Attributes*, *10-6 3G3PV Register Numbers, Classes, Instances, and Attributes*, and *10-7 3G3FV Register Numbers, Classes, Instances, and Attributes*.

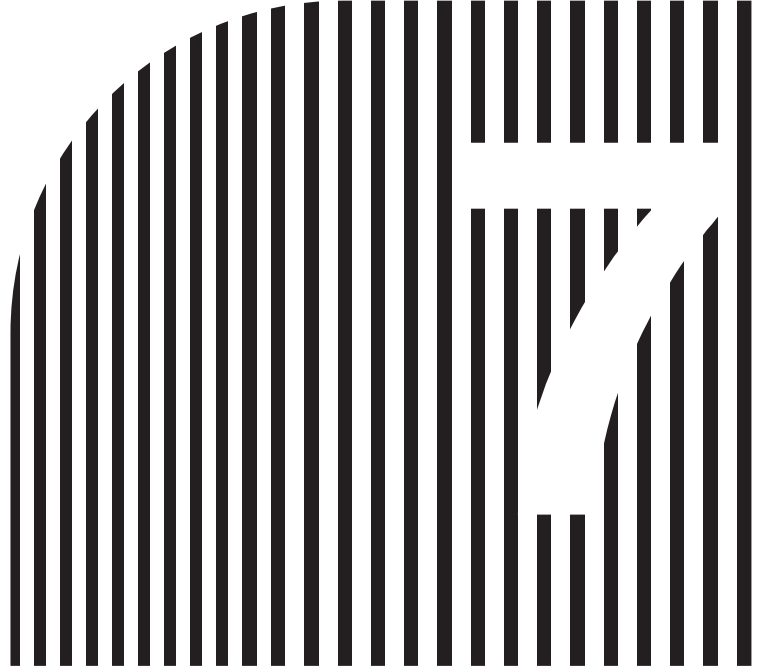

Chapter 7

Configurator Settings

- 7-1 Basic Configurator Operations
- 7-2 Smart Slave Functions
- 7-3 Edit Device Parameters Window
- 7-4 Monitor Device Window
- 7-5 Maintenance Information Window

This chapter describes the Smart Slave functions provided with the 3G3MV-PDRT2 DeviceNet Communications Unit and 3G3RV-PDRT2 DeviceNet Communications Card, and the methods for setting and monitoring these functions using the OMRON Configurator (Ver. 2.34).

Note If using a version of the Configurator earlier than Ver. 2.34, download the update module for the Configurator from the OMRON homepage and apply as specified.

7-1 Basic Configurator Operations

7-1-1 System Configuration for Smart Slave Functions

The operating methods described in this section are based on a system configuration using a Configurator connected and online as shown in the following diagram.

■ Configurator Connected to DeviceNet Network

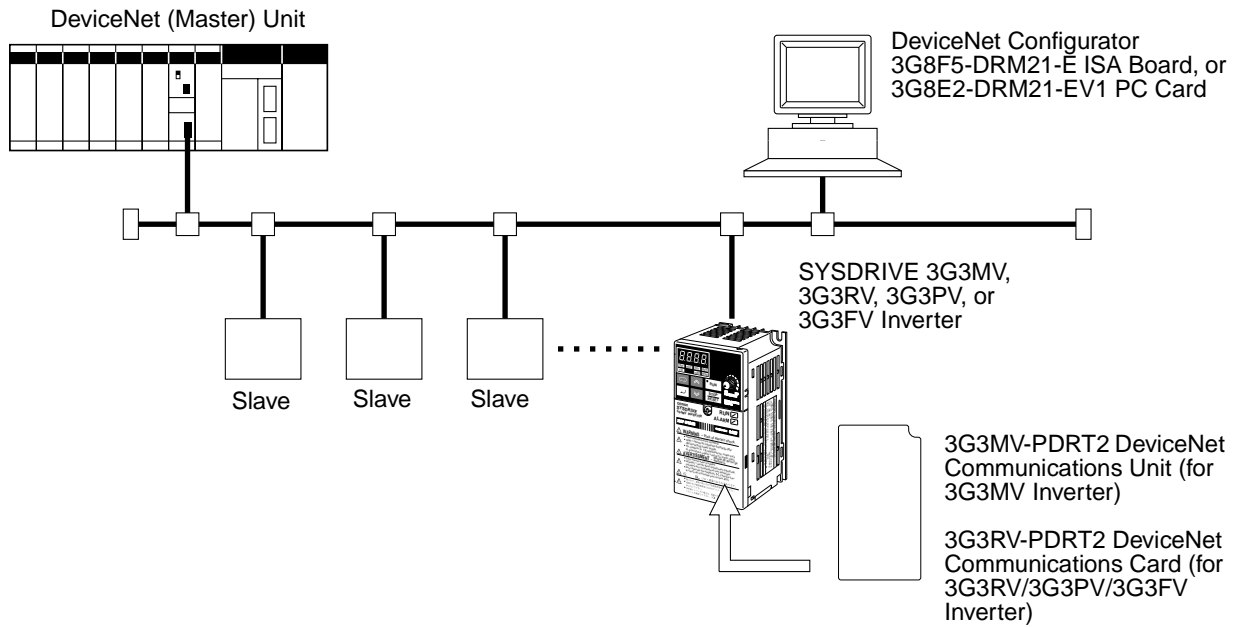

■ Configurator Connected to RS-232C Port of the CPU Unit

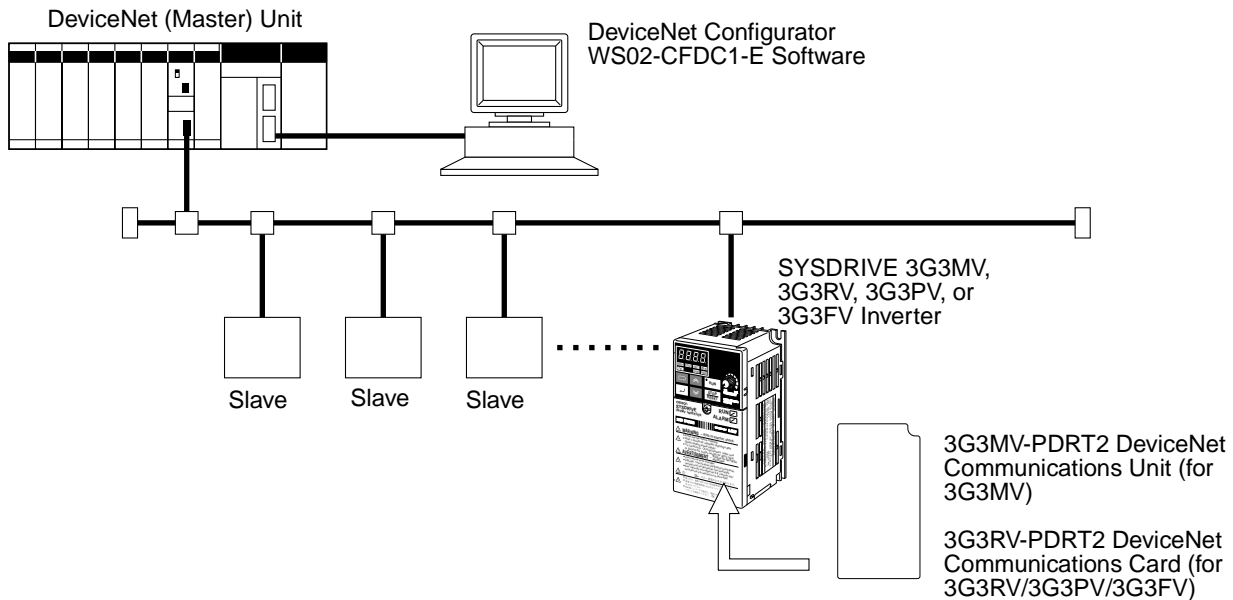

7-1-2 Displaying Windows

The methods for operating the window displays used for setting and accessing the Inverter’s Smart Slave functions are described here.

- Edit Device Parameters Window
This window is used to set the default connection path and each of the set values for the Smart Slave functions. After setting, the set values are shown in the Inverter by clicking the **Download** and **Reset** Buttons.
- Monitor Device Window
This window displays the online information that is always obtained from the Configurator. The present value can be displayed online or reset from this window.
- Maintenance Information Window
This window displays information specifically related to maintenance. The maintenance information is refreshed when this window is displayed or when the **Update** Button is clicked.

Note The methods used to operate each window are described here, but the network configuration must be created in the Configurator according to the system being used. Refer to the *DeviceNet Configurator Ver. 2.□ Operation Manual (W382)*.

■ Configurator Window (Example of Main Window)

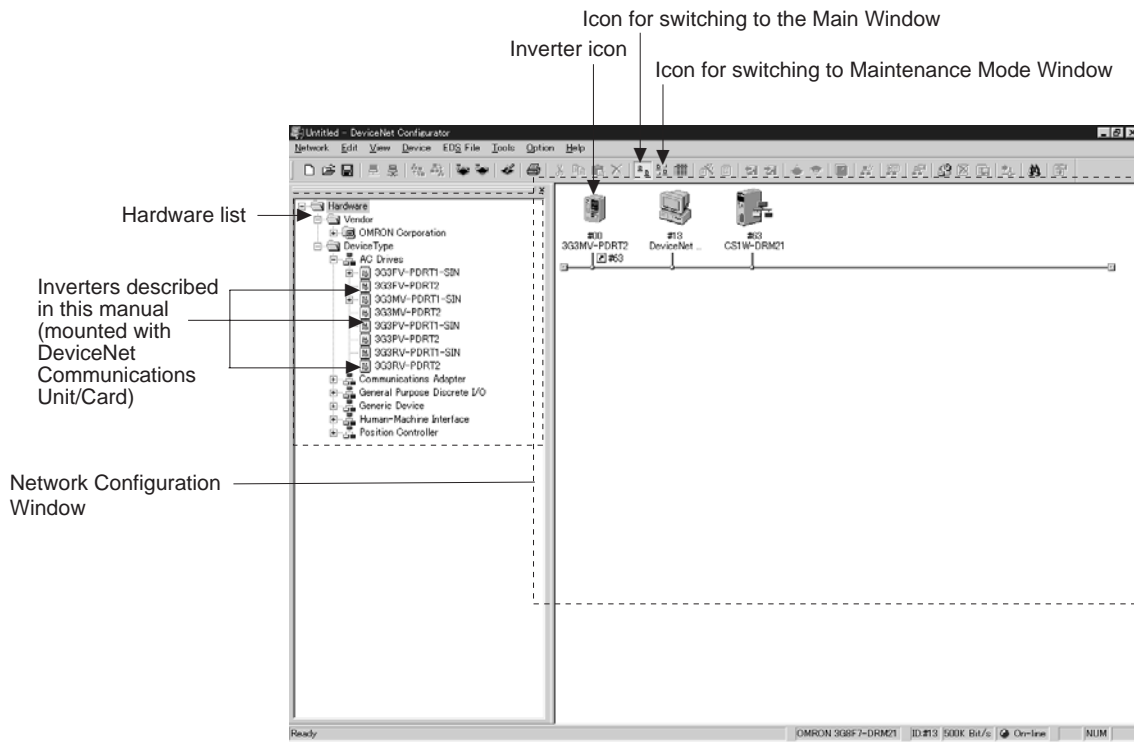

Note 1. For details on the standard Main Window (white background), and the Maintenance Mode Window (blue background), refer to the *DRT2-series DeviceNet Slaves Operation Manual* (W404).

Note 2. The 3G3FV-PDRT2 listing in the Hardware list refers to the 3G3RV-PDRT2 mounted to the 3G3FV-series Inverter. 3G3FV-PDRT2 is not a DeviceNet Communications Card model number.

■ Displaying the Edit Device Parameters Window

1. From the Main Window, double-click the icon of the corresponding Slave (Inverter) in the Network Configuration Window, or click the right mouse button over the icon and select **Parameter** and **Edit**.
2. From the Maintenance Mode Window, click the icon for the corresponding Slave (Inverter), click the right mouse button and select **Parameter** and **Edit**.
The Edit Device Parameters Window will be displayed.

Example of Operations from the Main Window

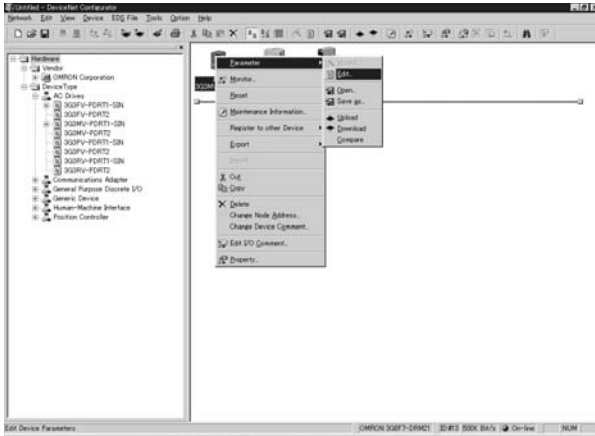

Click the right mouse button and select **Parameter** and **Edit**.

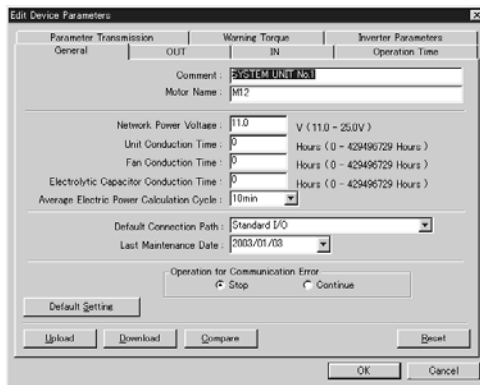

Edit Device Parameters Window

3. Click each of the tabs, i.e., the **General**, **OUT**, **IN**, **Operation Time**, **Parameter Transmission**, **Warning Torque**, and **Inverter Parameters** Tabs, and check the type of information that is displayed in each tab page.
4. Click the **Cancel** Button to close the Edit Device Parameters Window.

Note The setting methods used in each of the tab pages are described in the following pages.

■ Displaying the Monitor Device Window

1. The operation is the same from both the Main Window and the Maintenance Mode Window. Click the right mouse button over the icon of the corresponding Slave (Inverter) in the Network Configuration Window, and select **Monitor**. The Monitor Device Window will be displayed.

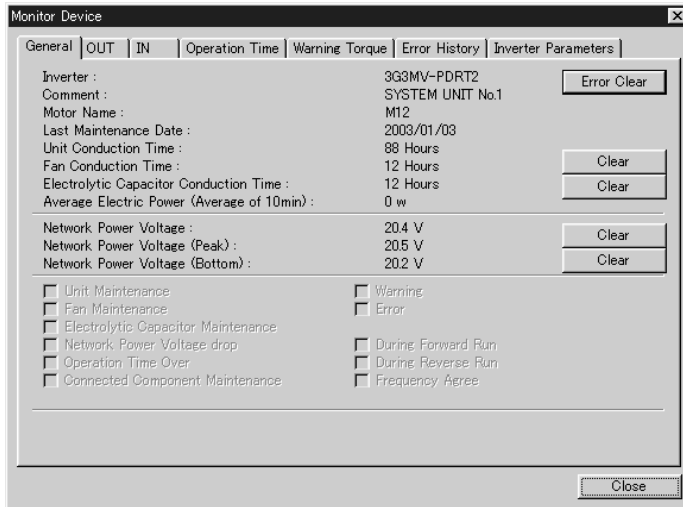

Monitor Device Window

2. Click each of the tabs in the window to check the information displayed in each tab page.
3. Click the **Close** Button to close the Monitor Device Window.

Note The setting methods used in each of the tab pages are described in the following pages.

■ Displaying the Maintenance Information Window

1. From the Main Window, click the right mouse button over the icon of the corresponding Slave (Inverter) in the Network Configuration Window, and select **Maintenance Information**. From the Maintenance Mode Window, double-click the icon of the corresponding Slave (Inverter) in the Network Configuration Window, or click the right mouse button over the icon and select **Maintenance Information**. The Maintenance Information Window will be displayed.

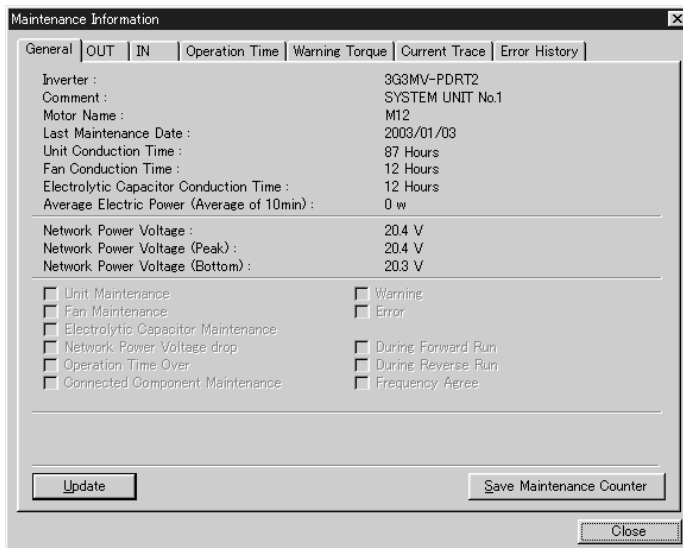

Maintenance Information Window

2. Click each of the tabs in the window to check the information displayed in each tab page.

3. Click the **Close** Button to close the Maintenance Information Window.

Note The setting methods used in each of the tab pages are described in the following pages.

7-1-3 Network Connection Precautions

When information is uploaded for the 3G3MV-PDRT2 and 3G3RV-PDRT2 Slaves and the DeviceNet (Master) Unit that are connected to the network, a warning icon may be displayed under the Slave. This icon indicates that the I/O size of the Slave and DeviceNet (Master) Unit do not match. If operation is continued without removing the cause of the warning icon, it will not be possible to see other detected errors in the Unit status, so always use the following method to match the I/O sizes and cancel the warning icon.

■ Operations Using the Configurator

1. Click the right mouse button over the icon of the corresponding Slave (Inverter) in the Network Configuration Window and select **Property**.

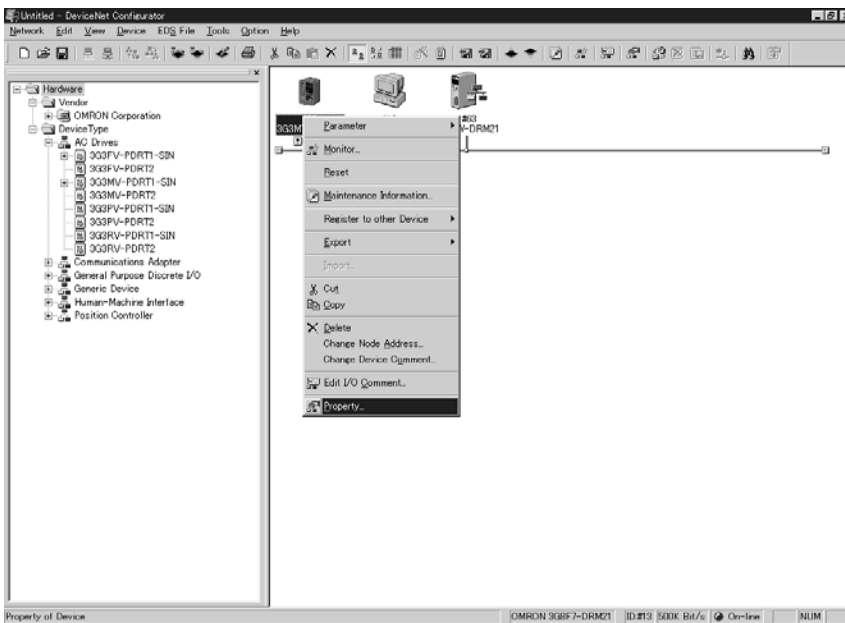

2. The Property Window for the 3G3MV-PDRT2 DeviceNet Communications Unit will be displayed (the model name will depend on the type of Inverter used). Click the **I/O Information** Tab. Click the **Get the I/O Size from the Scan List** Button and then close the window.

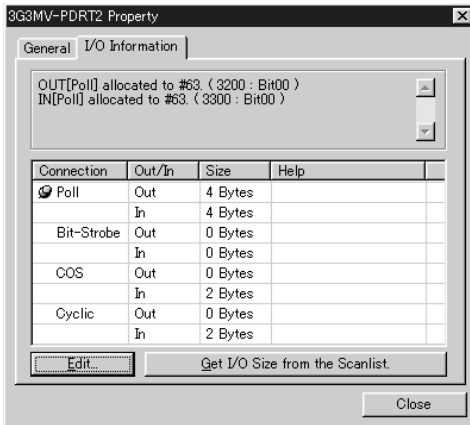

3. Check that the warning icon has been canceled from the Network Configuration Window.

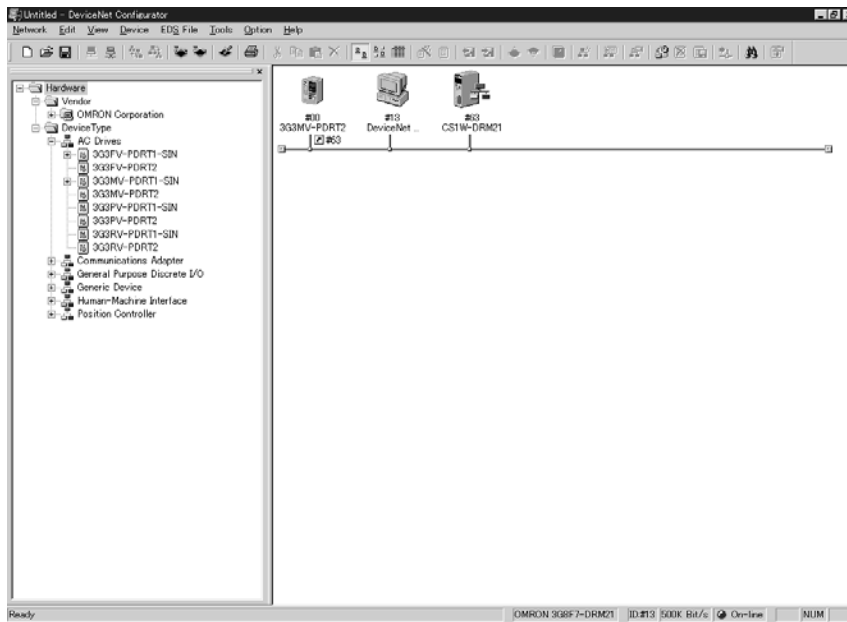

7-2 Smart Slave Functions

This section describes the details of Smart Slave functions and the operating procedures used in the Edit Device Parameters Window that is important for setting the Smart Slave functions. The details on setting and monitoring these functions from the Configurator are also provided here.

7-2-1 Precautions when Operating the Edit Device Parameters Window

Caution To set or change the settings in the Inverter's Edit Device Parameters Window, first click the **Upload** Button, and read the present set values for the Inverter. If the Download Button is clicked without first clicking the Upload Button, the parameter constants for the Inverter will be overwritten.

■ Setting and Changing Device Parameters

1. Displaying the Edit Device Parameters Window for the Inverter
 Display the Edit Device Parameters Window for the Inverter settings that are to be set or changed using the method shown in 7-1-2 *Displaying Windows*.
2. Reading the Inverter's Present Set Values
 Click the **Upload** Button to read the Inverter's present set values.

Note If the settings are made without performing this operation, all set values, including the parameter constants for the Inverter, will be overwritten. Particularly if the parameter constants have already been set using a Digital Operator or other device, all the parameter constants will be initialized and set to the default values set in the Configurator.

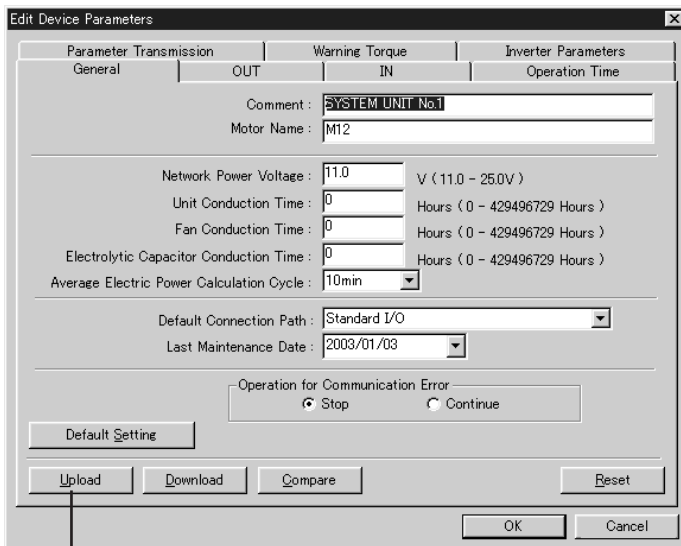

Edit Device Parameters Window

Click the **Upload** Button.

3. Set the Smart Slave functions.

Refer to the details on Smart Slave functions provided in the following pages, click each of the Tabs, and set or change the settings, as required.

4. Downloading the Set Values to the Inverter

Click the **General** Tab, and click the **Download** Button. All the set values will be sent to the Inverter.

5. Resetting the Inverter and Enabling the Set Values

Click the **Reset** Button to reset the Inverter, and enable the set values.

6. Completing the Operation

Click the **OK** Button. The Edit Device Parameters Window will close.

Note Details on Smart Slave functions and which windows are used to set or monitor these functions are provided in the following pages. The operating procedure explained here (i.e., displaying the Edit Device Parameters Window, clicking the Upload Button, making the settings, and clicking the Download Button, Reset Button, and OK Button) is not explained again.

7-2-2 Average Power Monitor Function

■ Functions

- This function monitors the power (kW) that the Inverter supplies each hour and determines the cumulative power usage from the hourly average.
- The power value during output is sampled at fixed intervals, and the average (moving average) is calculated from ten samples.
- The amount of power used by the system can be obtained without using special sensors or performing any calculations. In addition, monitoring the power usage can help reduce energy usage and identify power consumption problems in the system.
- The sampling cycle can be selected from 10 min, 30 min, or 1 hour.
- The Configurator can be used to monitor the average power simply.

Note When applications with frequent starting and stopping are being used, the output power varies widely according to the sampling timing. Therefore, the power usage cannot be monitored accurately. This function is effective for applications that do not involve much starting and stopping, such as for conveyors and fans.

■ Application Example

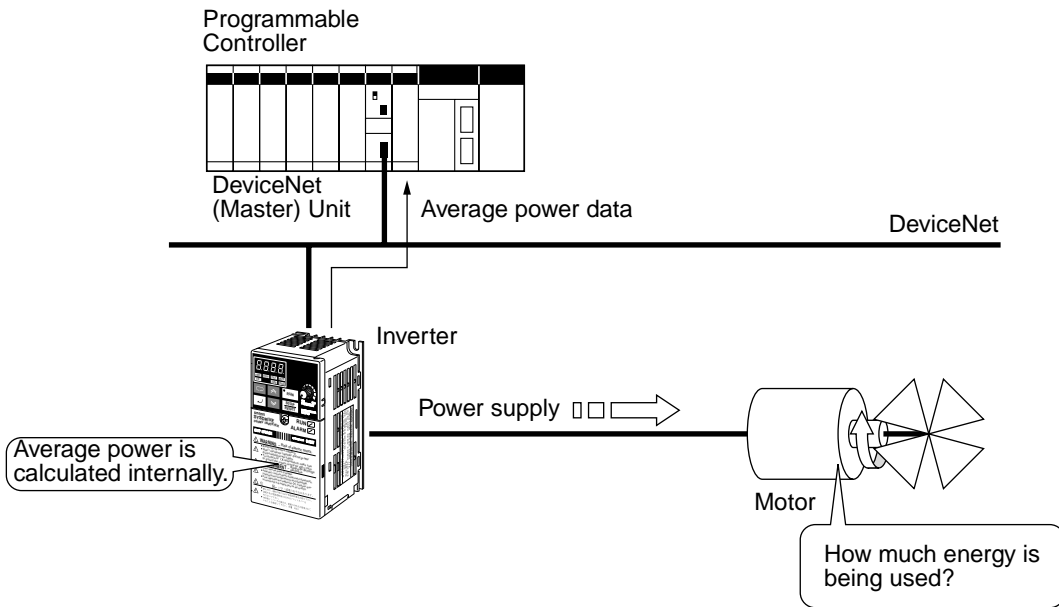

■ Setting Method

1. Click the **General** Tab in the Edit Device Parameters Window.
2. Select the desired calculation period from the pull-down menu for the *Average Electric Power Monitor Calculation Cycle* field.

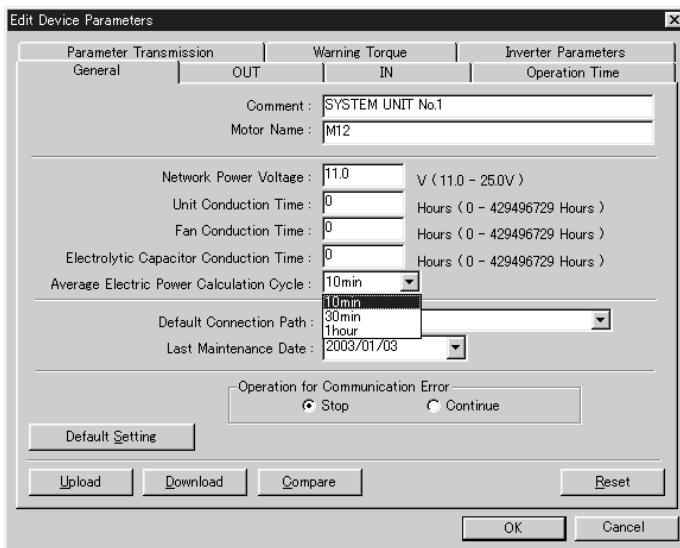

General Tab Page in the Edit Device Parameters Window

Note After downloading the settings to the Inverter, they will be enabled when the power to the Inverter is turned OFF once and then ON again, or the Inverter is reset (by clicking the Reset Button on the General Tab Page in the Edit Device Parameters Window). Until one of these (power OFF/ON or reset) is performed, the previous settings will be displayed when the settings are uploaded from the Inverter.

■ Monitoring Methods

● Using the Monitor Device Window

Click the **General** Tab in the Monitor Device Window. The present average power value will be displayed for the *Average Electric Power*.

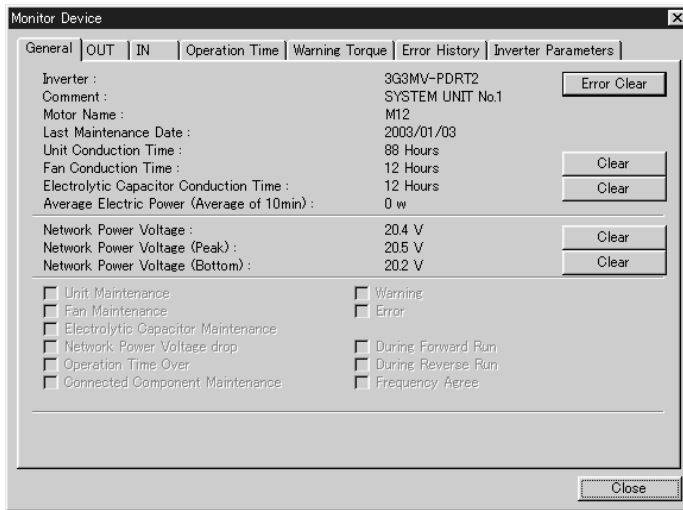

General Tab Page in the Monitor Device Window

● Using the Maintenance Information Window

Click the **General** Tab in the Maintenance Information Window. The present average power value will be displayed in the *Average Electric Power* field.

7-2-3 Warning Torque Detection

■ Functions

- This function can detect equipment errors by monitoring the output current.
- Problems in the load can be detected in the Inverter’s current (torque) level. The function provides advanced warning of an increased load caused by deterioration in the mechanical system (such as a loose chain, low bearing oil, or worn-out equipment), so preventative maintenance can be performed.
- The monitor values can be set for the output current level during acceleration and deceleration, and during frequency agreement (while operating at constant speed).
- When the detected output current is greater than or equal to the monitor value, a warning torque is detected.
- When a warning torque is detected, the Warning Torque Detection Flag in the Unit’s Status Area turns ON. Flags in the Unit’s Status Area can also be checked from the Configurator.

Note This function generates a warning (alarm), so operation continues.

■ Application Example

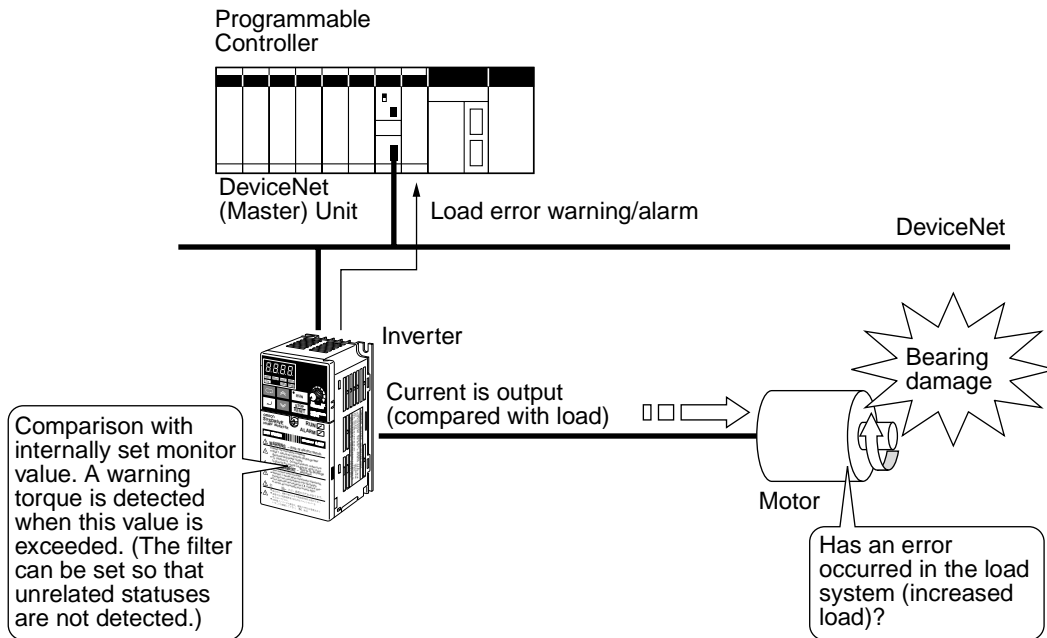

■ Setting Method

Click the **Warning Torque** Tab in the Edit Device Parameters Window, and set each setting item.

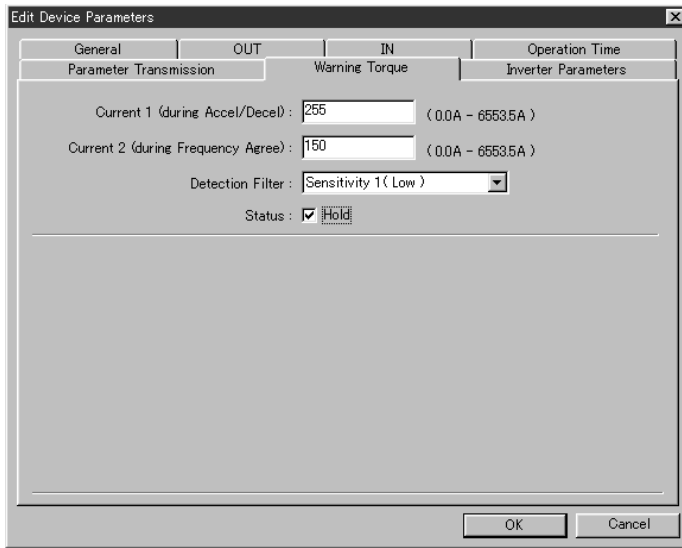

Warning Torque Tab Page in the Edit Device Parameters Window

Item	Setting range	Details
Current 1 (during Accel/Decel)	0.0 to 6,553.5 (A) (See note 1.)	Sets the monitor value (threshold) of the output current during acceleration or deceleration.
Current 2 (during Frequency Agree)	0.0 to 6,553.5 (A) (See note 2.)	Sets the monitor value (threshold) of the output current during frequency agreement (while operating at constant speed).
Detection Filter	Detection sensitivity level 1 (lowest) to level 5 (highest) (See note 3.)	Sets the level of sensitivity to prevent detection of values that temporarily exceed the threshold value.
Status	Hold or do not hold	Selected: Status is maintained when a warning torque is detected. Not selected: The status is refreshed every time.

Note 1. When *Current 1* is set to 0.0 (A), the warning torque during acceleration/deceleration is not detected.

Note 2. When *Current 2* is set to 0.0 (A), the warning torque during frequency agreement is not detected.

Note 3. A detection sensitivity level of 5 disables the filter. A detection sensitivity level of 1 uses the average of 5 sampled current levels (moving average) as the detection value.

■ Monitoring Methods

● Using the Monitor Device Window

- Click the **Warning Torque** Tab in the Monitor Device Window.
- The following information will be displayed.

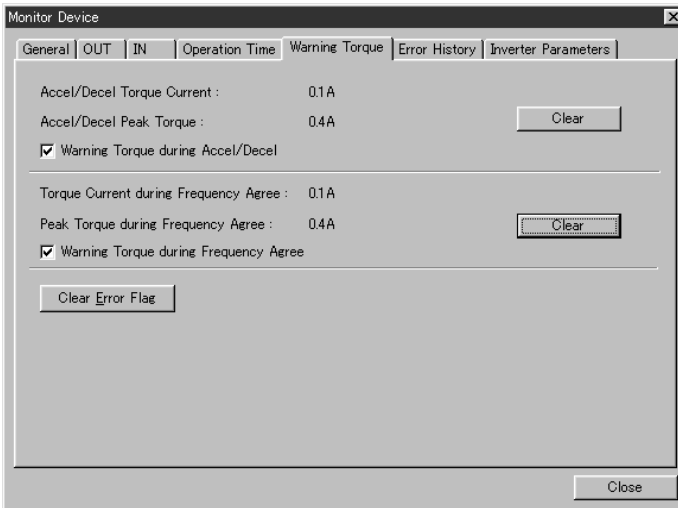

Warning Torque Tab Page in the Monitor Device Window

Item	Details
Accel/Decel Torque Current	Displays the output current monitor value (threshold) level during acceleration/ deceleration.
Accel/Decel Peak Torque	Displays the maximum output current level during acceleration/deceleration. Note: The value can be cleared to zero by clicking the Clear Peak Value Button on the right side of the window.
Warning Torque during Accel/Decel	Displays this item as selected when the output current level exceeds the monitor value (threshold) during acceleration/deceleration.
Torque Current during Frequency Agree	Displays the output current monitor value (threshold) level during frequency agreement.
Peak Torque during Frequency Agree	Displays the maximum output current level during frequency agreement. Note: The value can be cleared to zero by clicking the Clear Peak Value Button on the right side of the window.
Warning Torque during Frequency Agree	Displays this item as selected when the output current level exceeds the monitor value (threshold) during frequency agreement.
Clear Error Flag Button	Clears the Warning Torque Detection Flag in the Unit's Status Area. Note: This button is enabled when the <i>Status</i> field is selected on the Warning Torque Tab Page of the Edit Device Parameters Window.

● Using the Maintenance Information Window

Click the **Warning Torque** Tab in the Edit Device Parameters Window, and set each setting item.

Note The differences between the Warning Torque Tab Page in the Monitor Device Window and that in the Maintenance Information Window are as follows:

- The *Accel/Decel Peak Torque* and *Peak Torque (during Frequency Agree)* fields in the Maintenance Information Window do not show the present values, but the values when the maintenance information was last refreshed.
- The Clear Buttons for peak values and Clear Error Flag Button are not included in the Maintenance Information Window.

7-2-4 Current Trace

■ Functions

- This function traces (samples and records) the output current waveform to the motor.
- Troubleshooting can be performed easily, without connecting measuring equipment.
- The Configurator can be used to set the current trace's trigger setting, set the sampling cycle, and display the current waveform.
- The forward command, reverse command, frequency agree, or error signal can be used as the trigger, or the trigger can be activated manually (using button operations). By selecting an appropriate trigger, the data required (for example, from immediately before an error occurs) can be traced.
- The sampling cycle can be set to 10 ms, 20 ms, 50 ms, 100 ms, or a value up to 100 s. Up to 150 samples can be taken.
- Trace data can be converted into CSV format and saved in a file, allowing use of spreadsheet software such as Microsoft Excel.

■ Application Example

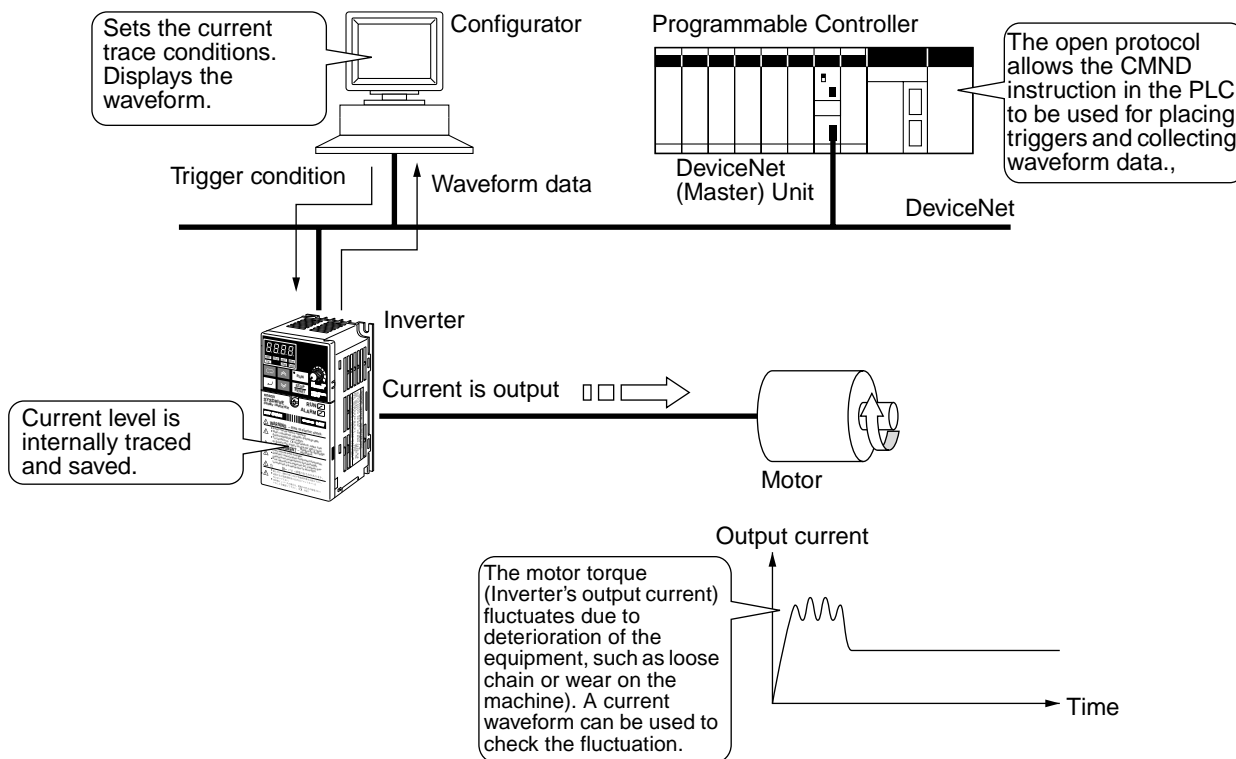

■ Setting Method

Click the **Current Trace** Tab in the Maintenance Information Window and set each item.

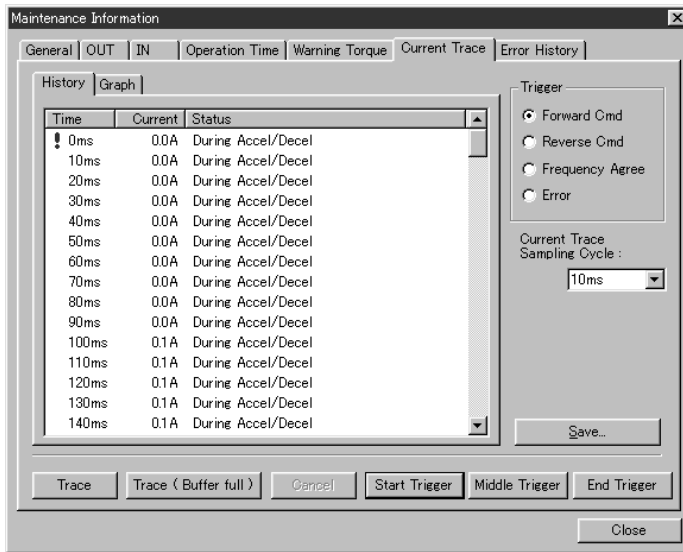

Current Trace Tab Page in the Maintenance Information Window

Item	Setting range	Details
Trigger	Forward run command, reverse run command, frequency agreement, or error	Sets the signal for trace timing. Note: The trace is performed by combining the trigger setting with the Start Trigger, Middle Trigger, and End Trigger Buttons.
Current Trace Sampling Cycle	10 ms, 20 ms, 50 ms, 100 ms, or a value up to 100 s	Select the trace sampling cycle from the pull-down menu.

■ Tracing Methods

Use the following button operations to perform traces.

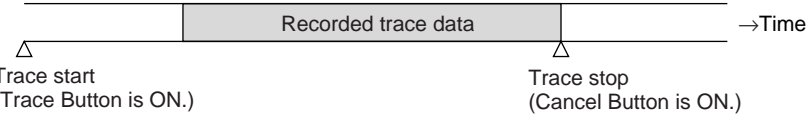
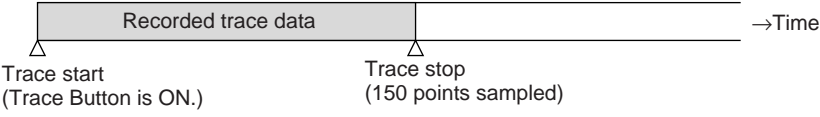
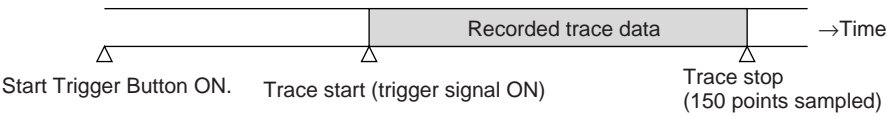
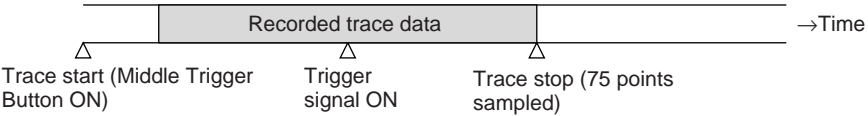
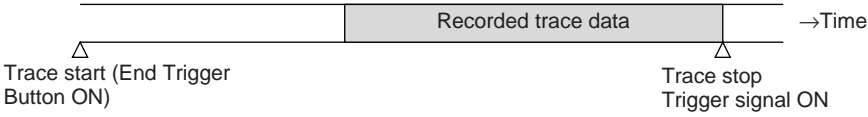
Button	Details
Trace	<p>Performs manual tracing. When this button is clicked, the trace starts, and when the Cancel Button is clicked, the trace stops.</p> <p>Note 1: When the amount of trace data exceeds 150 points, the oldest data is deleted.</p> <p>Note 2: The 150 points that exist in memory when the Cancel Button is clicked will be stored.</p> 
Trace (Buffer full)	<p>Performs manual tracing. When this button is clicked, the trace starts, and when 150 points have been sampled, the trace stops.</p> <p>Note: If the Cancel Button is clicked during the trace, the trace will stop.</p> 
Start Trigger	<p>Starts the trace using the signals selected in the <i>Trigger</i> field, and stops the trace when 150 points have been sampled.</p> <p>Note: The trace will also stop if the Cancel Button is clicked during the trace.</p> 
Middle Trigger	<p>When this button is clicked, the trace starts. When the signals selected in the <i>Trigger</i> field are turned ON, 75 points are sampled, and then the trace stops.</p> <p>Note 1: When the trigger signal is ON, the 75 points before the trigger and the 75 points after the trigger are recorded.</p> <p>Note 2: The trace also stops when the Cancel Button is clicked.</p> 
End Trigger	<p>When this button is clicked, the trace starts. When the signals selected in the <i>Trigger</i> field are turned ON, the trace stops.</p> <p>Note 1: The 150 points from immediately before the trigger signal turns ON are recorded.</p> <p>Note 2: The trace also stops when the Cancel Button is clicked.</p> 

■ Monitor Methods

The trace data can be checked on the History Tab Page and Graph Tab Page.

● History Tab Page

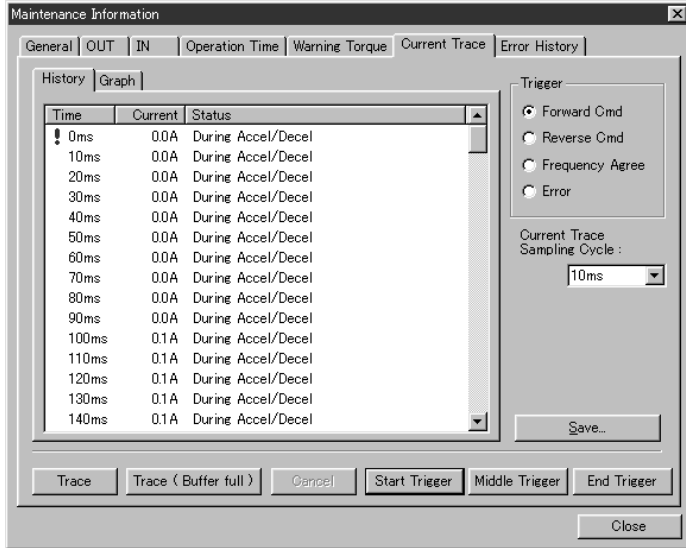

Current Trace Tab Page and History Tab Page in the Maintenance Information Window

Item	Details
Time	Displays the time determined from the current trace sampling cycle.
Current	Displays all current levels traced in every sampling cycle.
Status	Displays whether the sampling timing is during acceleration/deceleration or frequency agreement.
Save Button	Converts the traced data into CSV format and saves as a file. Note: When this button is clicked, the Save File Window is displayed.

● Graph Tab Page

The graph shown in this tab page consists of a vertical axis representing the current level shown in the History Tab Page, and a horizontal axis representing the time.

Note Other setting items and button functions in this tab page are the same as in the History Tab Page.

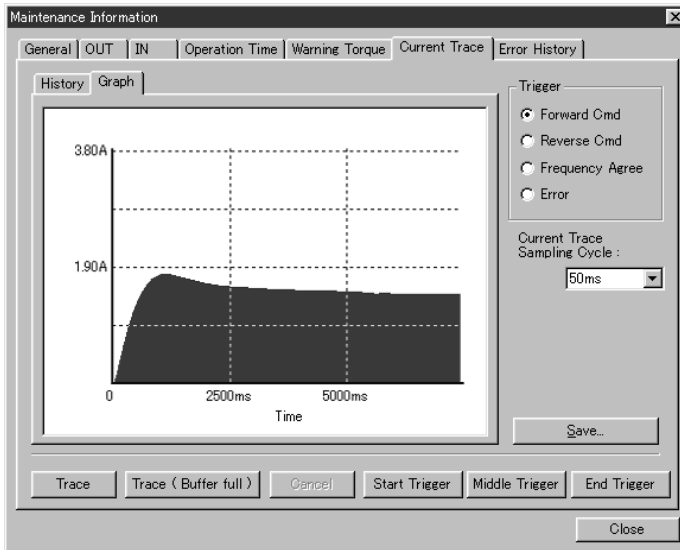

Current Trace Tab Page and Graph Tab Page in the Maintenance Information Window

7-2-5 Operating Time Monitor Function

■ Functions

- This function can perform a high-speed calculation in the Slave (independent of the ladder program) to determine the time required for an input to go ON after a particular signal or reference goes ON.
- By setting the monitor value, the operating time of the devices connected to the Inverter (motor and peripheral devices) can be monitored.
- The Operation Time Over Flag in the Unit’s Status Area turns ON when the operating time exceeds the monitor value.

- The combination of start signal (and command) and completion signal for operating time measurement are determined as shown in the following table.

No.	Operating time measurement trigger		Remarks
	Measurement start condition	Measurement completion condition	
00	Multi-function contact output: ON	Input 4: ON	Output to input
01	Multi-function output 1: ON	Input 5: ON	Output to input
02	Input 2: ON	Input 3: ON	Input to input
03	Input 4: ON	Input 5: ON	Input to input
04	Input 0 is ON, input 1 is ON, or a forward/reverse run command is sent from the network.	Input 4: ON	Forward/reverse run command to input
05	Input 0 is ON, input 1 is ON, or a forward/reverse run command is sent from the network.	Input 5: ON	Forward/reverse run command to input

Note 1. The input references in the above table refer to the inputs in the following table. When control I/O remote I/O is used, the input will be turned ON not only when the terminal's signal is ON, but also when the corresponding bit is turned ON from remote I/O. (The terminal's ON/OFF status is logically ORed with the status of the bit sent through remote I/O.)

Name			
	3G3MV	3G3RV/3G3PV	3G3FV
Input 0	Terminal S1 (multi-function input 1) status	Terminal S1 (forward run/stop) status	Terminal 1 (forward run/stop) status
Input 1	Terminal S2 (multi-function input 2) status	Terminal S2 (reverse run/stop) status	Terminal 2 (reverse run/stop) status
Input 2	Terminal S3 (multi-function input 3) status	Terminal S3 (multi-function input selection 1) status	Terminal 3 (multi-function contact input 1) status
Input 3	Terminal S4 (multi-function input 4) status	Terminal S4 (multi-function input selection 2) status	Terminal 4 (multi-function contact input 2) status
Input 4	Terminal S5 (multi-function input 5) status	Terminal S5 (multi-function input selection 3) status	Terminal 5 (multi-function contact input 3) status
Input 5	Terminal S6 (multi-function input 6) status	Terminal S6 (multi-function input selection 4) status	Terminal 6 (multi-function contact input 4) status

Note 2. The combination of 00 and 01 is valid when combined with control I/O remote I/O and the following parameter settings.
 3G3MV: When 18 (12 hex) (communications output) is set in n057 and n058 (multi-function outputs 1 and 2).
 3G3RV/3G3PV/3G3FV: When F (not used) is set in H2-01 and H2-02 (multi-function contact output and multi-function output 1).
 Under these conditions, output from the Inverter control terminal can be controlled by communications, and these signals can be used as triggers to start measurement.

■ Application Example

● Output-to-input Example

It is possible to detect deterioration in cylinder operation and estimate expiration of the cylinder's service life by using the Inverter's multi-function output to drive the cylinder and inputting the cylinder's travel completed signal in the multi-function input.

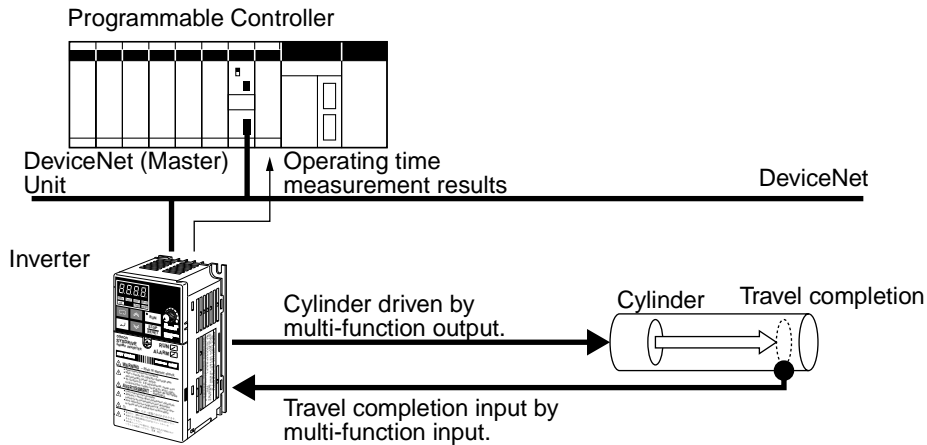

● **Input-to-input Example**

It is possible to detect deterioration in conveyor operation and estimate expiration of the conveyor's service life by inputting sensor signals from two locations on the conveyor into the Inverter's multi-function input.

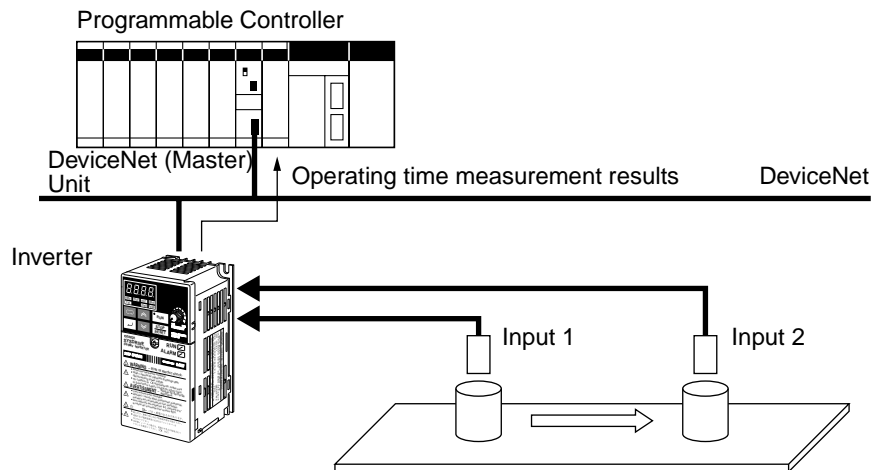

● **Forward/Reverse Run Command-to-input Example**

It is possible to detect deterioration in the mechanical system and estimate expiration of the equipment's service life by inputting the signals from sensors installed in the mechanical system driven by the motor.

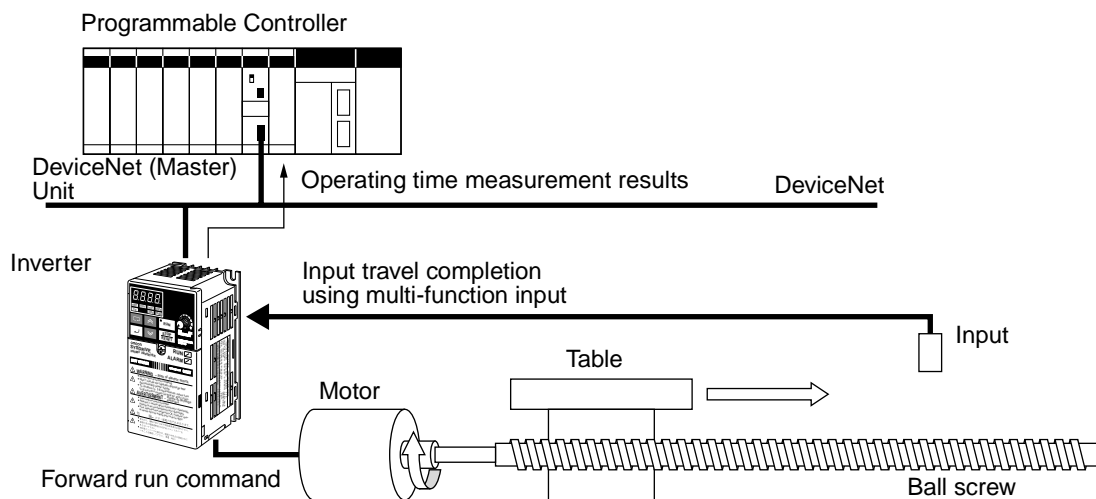

■ Setting Method

1. Click the **Operation Time** Tab in the Edit Device Parameters Window.
The numerals 00 to 05 in the *No.* field correspond to the combinations of signals for the operating time measurement explained in *7-2-5 Operating Time Monitor Function*.
2. Double-click the area to be set, or select the field to be set and then click the **Edit** Button. The setting window will be displayed.

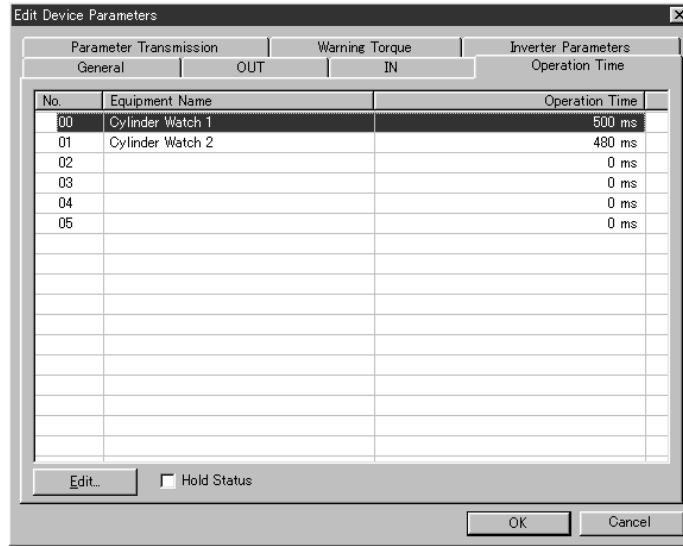

Operation Time Tab Page in the Edit Device Parameters Window



Double-click the selected field, or click the **Edit** Button.

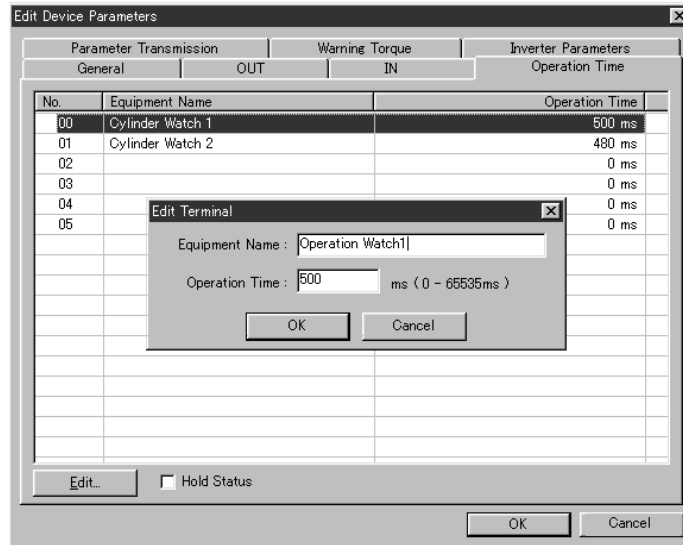

Item	Setting range	Details
Equipment Name	(User-set name)	Set any name for each device. Note: The name set here is displayed in the <i>Equipment Name</i> field.
Operation Time	0 to 65,535 ms	Set the monitor value. Note: The name set here is displayed in the <i>Operation Time</i> field.
Hold Status Button	Hold or do not hold	Selected: When an operation time monitoring error is detected, this status is held. Not selected: The status is refreshed every time.

■ Monitoring Methods

● Using the Monitor Device Window

- Click the **Operation Time** Tab in the Monitor Device Window.
- The following information will be displayed.

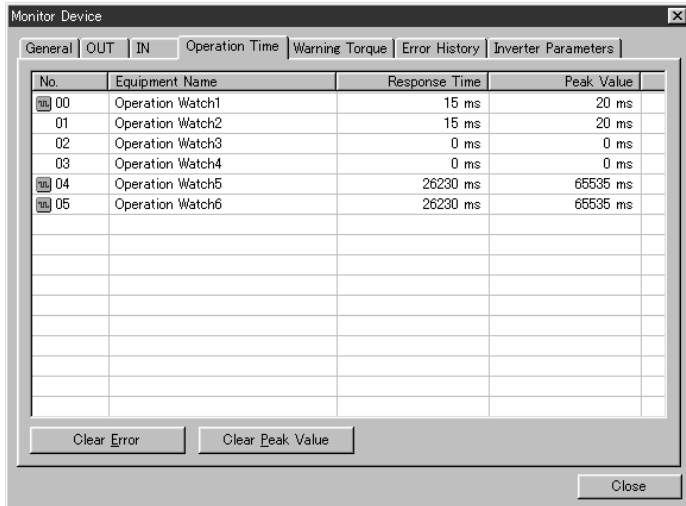

Operation Time Tab Page in the Monitor Device Window

Item	Details
No.	Displays a number indicating the combination of start signals and end signals of the operating time measurement. An error icon will be displayed to the left of the number if the response time exceeds the monitor value.
Equipment Name	Displays the name of each device.
Response Time	Displays the operating time (present value) of each device.
Peak Value	Displays the maximum operating time of each device.
Clear Error Button	Clears the Operation Time Over Flag in the Unit's Status Area. Note: This button is enabled when the <i>Status Hold</i> field is selected (to hold statuses) on the Operation Time Tab Page in the Edit Device Parameters Window.
Clear Peak Value Button	Clears the operation time peak value to zero. Note: Select the device for which the peak value is to be cleared, and click the Peak Value Clear Button to clear the value to zero.

Note The ON/OFF status of the Operation Time Over Monitor Flag can be checked on the General Tab Page of the Monitor Device Window. When this flag is ON, *Operation Time Over* check box will be selected.

● Using the Maintenance Information Window

- Click the **Operation Time** Tab in the Maintenance Information Window.

Note The differences between the **Operation Time** Tab Page in the Monitor Device Window and in the Maintenance Information Window are as follows:

- The *Operation Time* field in the Maintenance Information Window shows the value when the maintenance information was refreshed and not the present value.

- The Clear Buttons for peak values and Clear Error Button are not included in the Maintenance Information Window.

7-2-6 Cumulative ON Time Monitor

■ Functions

- This function totals the time that one of the Inverter's control I/O terminals is ON by the second.
- For example, if the RUN output's ON time is totaled, it is possible to calculate the Inverter's operating time and monitor equipment operating time without using the ladder program.
 - By measuring the total ON time of the input device connected to the input terminal, the replacement time of the input device can be determined.
 - By measuring the total ON time of the output device connected to the output terminal, the replacement time of the output device can be determined.
- The total ON time for every I/O terminal can be measured, and a monitor value can be set for each terminal.
- When the total ON time of the terminal reaches the monitor value or higher, the Connected Component Maintenance Flag will turn ON in the Unit's Status Area.

Note 1. The input from the Inverter's control terminal block is ORed with the input from DeviceNet communications, so the input is considered ON when either input source is ON. For example, when either the RUN/STOP signal is input from the control terminal block or the input is being received from DeviceNet communications, the corresponding multi-function input terminal is considered as ON and the ON time is added.

Note 2. Either the cumulative ON time monitor or the contact operations monitor (refer to the following function) can be set in each I/O terminal. Both functions cannot be set for the same terminal.

Note 3. The total ON time is written to the EEPROM (in the DeviceNet Communications Unit or Card) approximately every six minutes. Therefore, depending on the power OFF timing, up to six minutes worth of data may be lost. To monitor more closely, click the **Save Maintenance Counter** Button located on the General Tab Page of the Maintenance Information Window immediately before turning OFF the power. The maintenance information including the total ON time will be written to the EEPROM.

■ Application Example

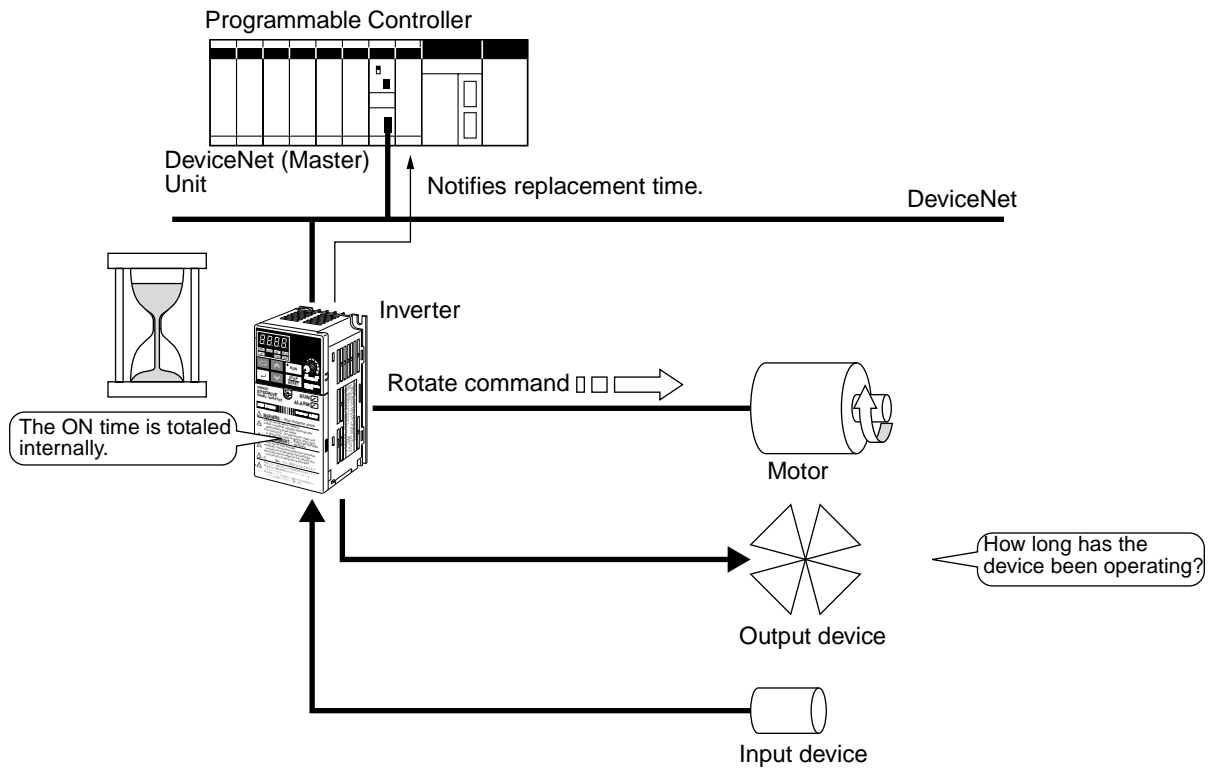

■ Setting Methods

Make the settings for the output terminal (or input terminal) on the OUT Tab Page (or IN Tab Page) of the Edit Device Parameters Window.

● OUT Tab Page Settings

1. Click the **OUT** Tab in the Edit Device Parameters Window.
 The numerals 00 to 02 in the No. field indicate the following output terminals.
 00: Multi-function contact output, 01: Multi-function output 1, 02: Multi-function output 2
2. Double-click the fields to be set, or select the field to be set and click the **Edit** Button to display the setting window.

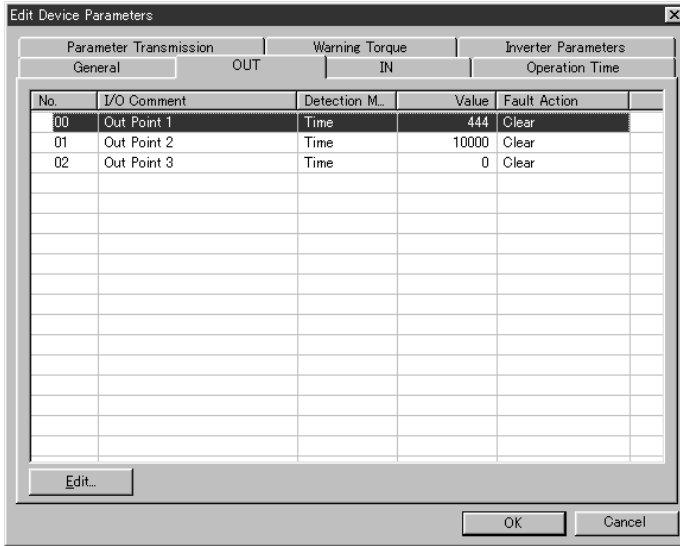

OUT Tab Page in the Edit Device Parameters Window



Double-click the fields to be set, or click the **Edit** Button.

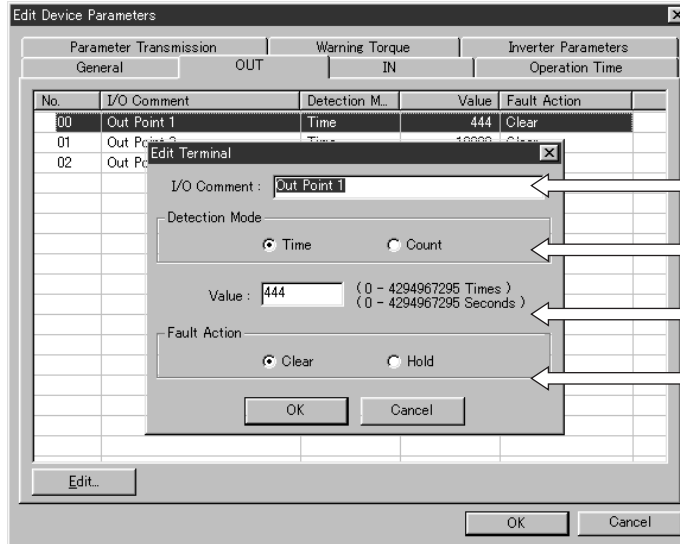

Set the name of the connected device.
(Refer to 7-2-11 Connected Device Comment.)

Select either **Time** or **Count** as the detection mode.

Set the monitor time (in seconds) if using the cumulative ON time function.

Set whether to clear (OFF) or hold the output status when a communications error occurs.

● IN Tab Page Settings

1. Click the **IN** Tab in the Edit Device Parameters Window.

The numerals in the *No.* field indicate the following input terminals.

No.	Details		
	3G3MV	3G3RV/3G3PV	3G3FV
00	Terminal S1 (multi-function input 1)	Terminal S1 (forward run/stop)	Terminal 1 (forward run/stop)
01	Terminal S2 (multi-function input 2)	Terminal S2 (reverse run/stop)	Terminal 2 (reverse run/stop)
02	Terminal S3 (multi-function input 3)	Terminal S3 (multi-function input selection 1)	Terminal 3 (multi-function contact input 1)

No.	Details		
	3G3MV	3G3RV/3G3PV	3G3FV
03	Terminal S4 (multi-function input 4)	Terminal S4 (multi-function input selection 2)	Terminal 4 (multi-function contact input 2)
04	Terminal S5 (multi-function input 5)	Terminal S5 (multi-function input selection 3)	Terminal 5 (multi-function contact input 3)
05	Terminal S6 (multi-function input 6)	Terminal S6 (multi-function input selection 4)	Terminal 6 (multi-function contact input 4)
06	Terminal S7 (multi-function input 7)	Terminal S7 (multi-function input selection 5)	Terminal 7 (multi-function contact input 5)
07			Terminal 8 (multi-function contact input 6)

2. Double-click the field to be set, or select the field to be set and click the **Edit** Button to display the setting window.

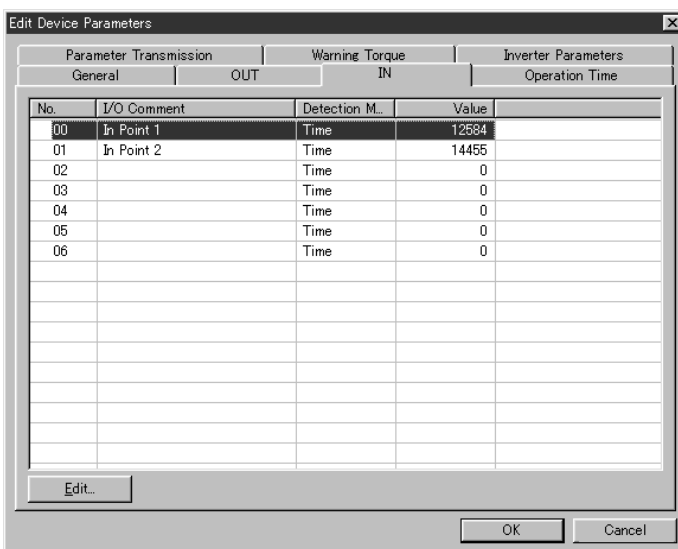

IN Tab Page in the Edit Device Parameters Window



Double-click the selected field, or click the **Edit** Button.

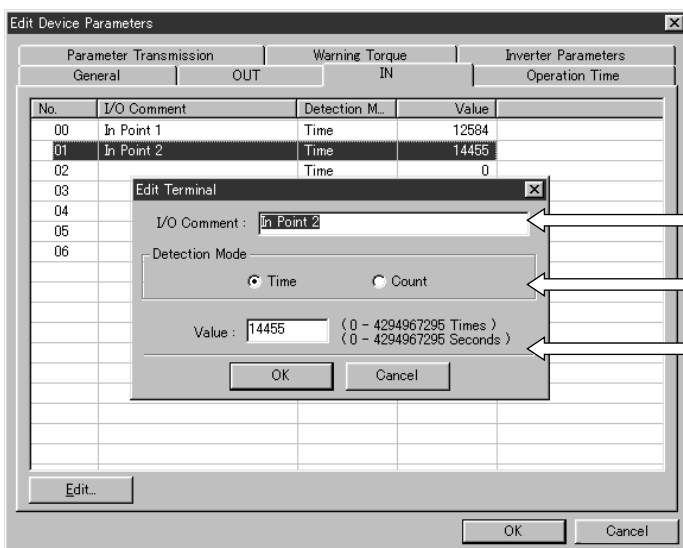

Set the name of the connected device. (Refer to 7-2-11 Connected Device Comment.)

Select either **Time** or **Count** as the detection mode.

Set the monitor time (in seconds) if using the cumulative ON time function.

■ Monitoring Methods

● Using the Monitor Device Window

- Click the **OUT** Tab or **IN** Tab in the Monitor Device Window to monitor in outputs/inputs.
- The following information will be displayed.

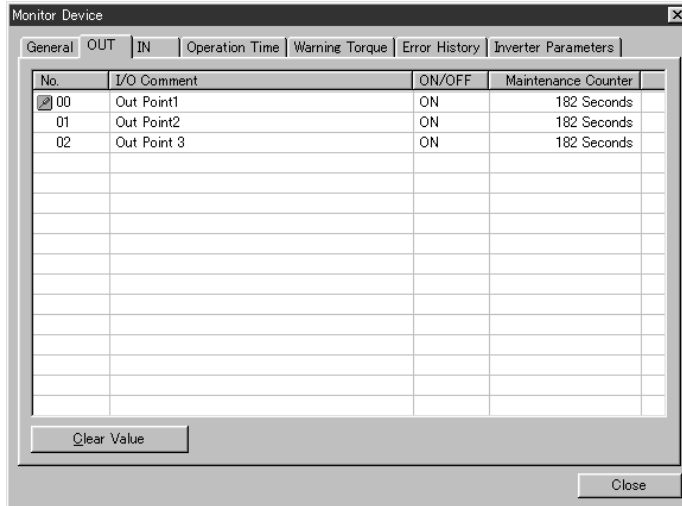

OUT Tab Page in the Monitor Device Window

Item	Details
No.	The settings in the No. field are as follows: 00: Multi-function contact output, 01: Multi-function output 1, 02: Multi-function output 2 Note: When the present value of the maintenance counter (total ON time or contact operations counter) exceeds the monitor value, the error icon is displayed on the left side of the corresponding No. setting.
I/O Comment	Displays the comment for the connected device for each output terminal.
ON/OFF	Displays the ON/OFF status (present value status) for each output terminal.
Maintenance Counter	Displays the present value of the maintenance counter for each output terminal. Note: The total ON time (s) or contact operations count (No. of times) is displayed.
Clear Value Button	Clears the present value of the maintenance counter to zero. Note: Select the terminal to be cleared, click the Clear Value Button to clear the value to zero.

Note 1. The monitoring items in the IN Tab Page are similar to the OUT Tab Page. The numeric values in the No. field, however, indicate each input terminal. (Refer to page 7-29.)

Note 2. The ON/OFF status of the Connected Component Maintenance Flag can be checked on the General Tab Page of the Monitor Device Window. When this flag is ON, the *Connected Component Maintenance* check box will be selected.

● Using the Maintenance Information Window

Click the **OUT** Tab or **IN** Tab in the Maintenance Information Window.

Note The differences between the **OUT** Tab Page and **IN** Tab Page in the Monitor Device Window and in the Maintenance Information Window are as follows:

- The *Maintenance Counter* field shows the value when the maintenance information was refreshed and not the present value.
- The Clear Monitor Present Value Button is not included in this window.
- The maintenance counter can be saved (written to the EEPROM) by clicking the Save Maintenance Counter Button.

7-2-7 Contact Operations Monitor

■ Functions

- This function counts the number of times that one of the Inverter's control I/O terminals goes ON.
- The number of contact operations can be useful in maintenance, e.g., it can indicate when a connected device needs to be replaced.
- The contact operations can be counted for each I/O terminal and a monitor value set for each terminal.
- When the number of contact operations of the terminal reaches or exceeds the monitor value, the Connected Component Maintenance Flag will turn ON in the Unit's Status Area.

Note 1. The terminal is considered ON when the ON time reaches or exceeds 20 ms.

Note 2. The input from the Inverter's control terminal block is ORed with the input from DeviceNet communications. Therefore, for example, when either the RUN/STOP signal is input from the control terminal block or the input is being received from DeviceNet communications, the corresponding multi-function input terminal is considered as ON and the contact operation is counted.

Note 3. Either the cumulative ON time monitor (refer to the previous function) or the contact operations monitor can be set for each I/O terminal. Both functions cannot be set for the same terminal.

Note 4. The number of contact operations is written to the EEPROM (in the DeviceNet Communications Unit or Card) approximately every six minutes. Therefore, depending on the power OFF timing, up to six minutes worth of data may be lost. To monitor more closely, click the **Save Maintenance Counter** Button located on the General Tab Page of the Maintenance Information Window immediately before turning OFF the power. The maintenance information including the number of contact operations will be written to the EEPROM.

■ Application Example

The applications are the same as for the Cumulative ON Time Monitor (refer to the previous function).

■ Setting and Monitoring Methods

Use the same methods for the Cumulative ON Time Monitor (refer to the previous function).

7-2-8 Conduction Time Monitor

■ Functions

- The time that power is supplied to the Slave's internal circuit power supply is totaled and recorded every 0.1 hours (six minutes).
- The DeviceNet Communications Unit/Card has three monitor values that can be set independently for the following three time monitoring functions. Each of these values, however, is a total of the time that the Inverter's power is ON, and the fan and electrolytic capacitor are not monitored separately. Use these operating times as a guide for when the corresponding parts need to be replaced.

Main Unit operating time	Cannot be reset.
Fan operating time	The present value can be reset to zero.
Electrolytic capacitor operating time	The present value can be reset to zero.

- When the Main Unit operating time reaches or exceeds the monitor value, the Unit Maintenance Flag will turn ON in the Unit's Status Area.
- When the fan operating time or electrolytic capacitor operating time reaches or exceeds the monitor value, the Unit Maintenance Flag (fan or electrolytic capacitor) will turn ON in the Unit's Status Area.
- Since the fan operating time and electrolytic capacitor operating time are used to indicate when those parts need to be replaced, these monitoring times can be reset to zero

Note The Conduction Time is written to the EEPROM (in the DeviceNet Communications Unit or Card) approximately every six minutes. Therefore, depending on the power OFF timing, up to six minutes worth of data may be lost. To monitor more closely, click the **Save Maintenance Counter** Button located on the General Tab Page of the Maintenance Information Window immediately before turning OFF the power. The maintenance information including the Conduction Time will be written to the EEPROM.

■ Application Example

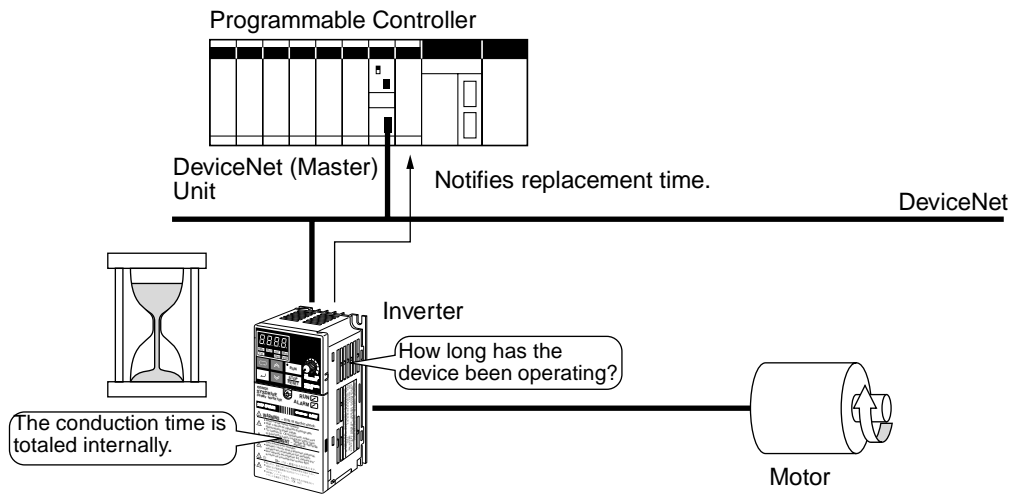

■ Setting Methods

1. Click the **General** Tab in the Edit Device Parameters Window.
2. Set the corresponding monitoring times in the *Unit Conduction Time*, *Fan Conduction Time*, and *Electrolytic Capacitor Conduction Time* fields.

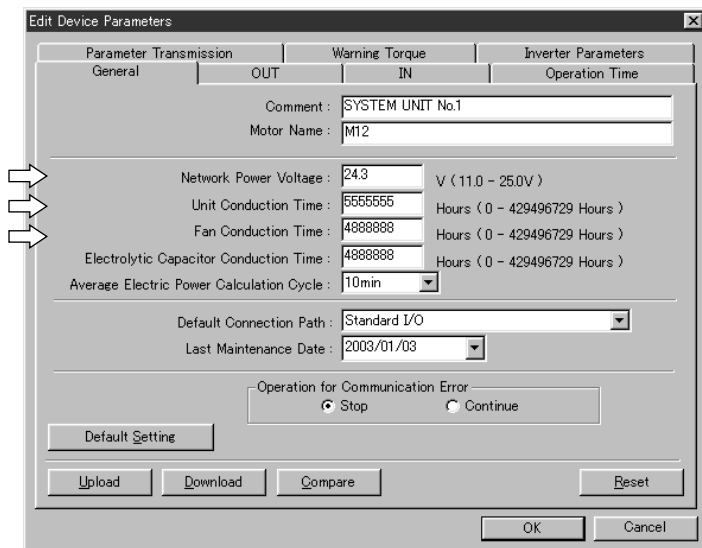

General Tab Page in the Edit Device Parameters Window

The following table shows a guide to the settings.

Item	Setting guide	Remarks
Unit Conduction Time	30,000 hr or higher	30,000 hr = 8 hr per day for approximately 10 years.
Fan Conduction Time	6,000 to 8,000 hr	6,000 hr = 8 hr per day for approximately 2 years.
Electrolytic Capacitor Conduction Time	15,000 to 20,000 hr	15,000 = 8 hr per day for approximately 5 years.

Note 1. Set the values above using the guide for Inverter maintenance. (Refer to the inspection and maintenance information in the operation manual for the Inverter being used.)

Note 2. The calculations shown here are based on usage conditions with an ambient temperature of 40 °C, 80% load ratio, and operation time of eight hours per day, and installation standards in the manual.

When poorer conditions are used, set a time that is shorter than the times in the above table. For example, if the ambient temperature is higher, with the fan life of approximately 6,000 hours, set an earlier inspection period. If the environment is better than these conditions, set the value to 8,000 hours.

Note 3. When the machine operating time is shorter than the Unit conduction time of the Inverter, consider the operating time per day of conduction time when calculating.

Example: When power is ON 24 hours per day, but operating time is only six hours.
 Fan conduction time: $8,000 \times 24/6 = 32,000$ (hr)

■ Monitoring Methods

● Using the Monitor Device Window

Click the **General** Tab in the Monitor Device Window.

- The present conduction times are displayed in the *Unit Conduction Time*, *Fan Conduction Time*, and *Electrolytic Capacitor Conduction Time* fields.
- The items in the unit status report area can be used to check whether the Conduction Time has reached or exceeded the monitor value. When the monitor value is exceeded, the corresponding item is shown as selected.

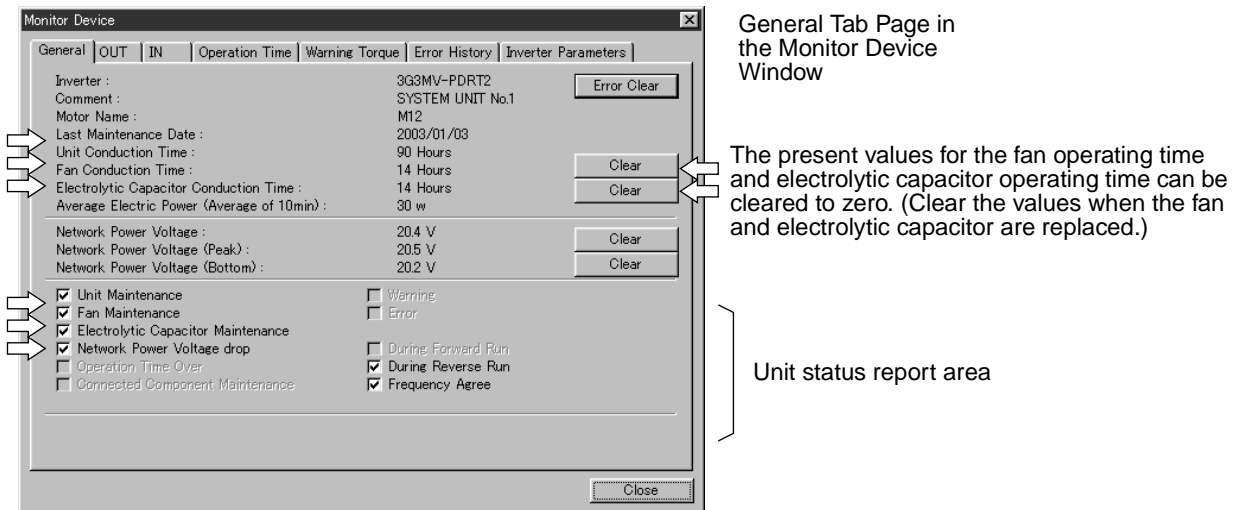

● Using the Maintenance Information Window

Click the **General** Tab in the Maintenance Information Window.

Note The differences from the Monitor Device Window are as follows:

- The *Conduction Time* Fields in the Maintenance Information Window show the values when the maintenance information was last refreshed and not the present value.
- The Clear Buttons for present values are not included in the Maintenance Information Window.

- The conduction time can be saved (written to the EEPROM) by clicking the Save Maintenance Counter Button.

7-2-9 Network Power Supply Voltage Monitor

■ Functions

- The network power supply values are monitored with this function.
- The network power supply values (present value, maximum value, and minimum value) can be recorded in the DeviceNet Communications Unit/Card.
- The network power supply voltage monitor value (factory setting: 11 V) can be set.
- When the voltage drops below the monitor voltage set in the Slave, the Network Power Voltage Drop Flag turns ON in the Unit's Status Area.

Note 1. The communications power supply voltage for DeviceNet is a minimum of 11 V. Therefore, if the power supply voltage is lower than 11 V, the Configurator or explicit messages may not read process values correctly.

Note 2. The maximum and minimum values for the network power supply voltage are cleared when the network power supply is turned OFF.

■ Setting Methods

1. Click the **General** Tab in the Edit Device Parameters Window.
2. Set the monitor voltage in the *Network Power Voltage* field.

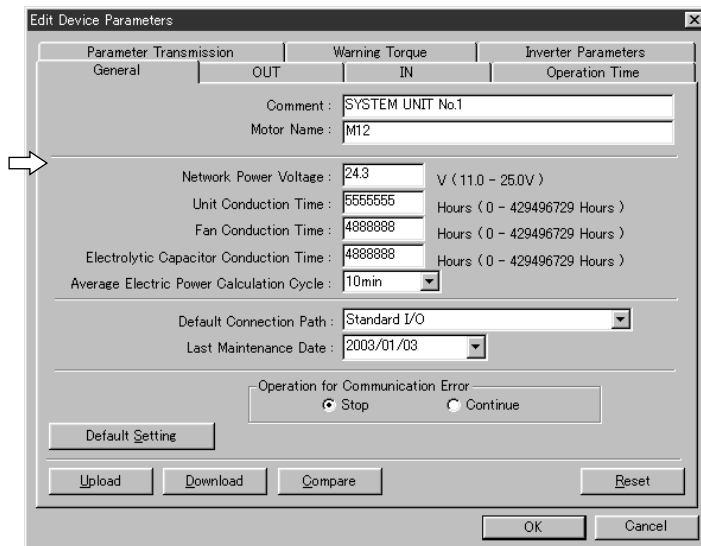

General Tab Page in the Edit Device Parameters Window

■ **Monitoring Methods**

● **Using the Monitor Device Window**

Click the **General** Tab in the Monitor Device Window.

- The voltage values are displayed in the *Network Power Voltage*, *Network Power Voltage (Peak)*, and *Network Power Voltage (Bottom)* fields.
- The ON/OFF status of the Network Power Voltage Drop Flag can be checked in the Unit status report area. When the flag is ON, the *Network Power Voltage Drop* check box is selected.

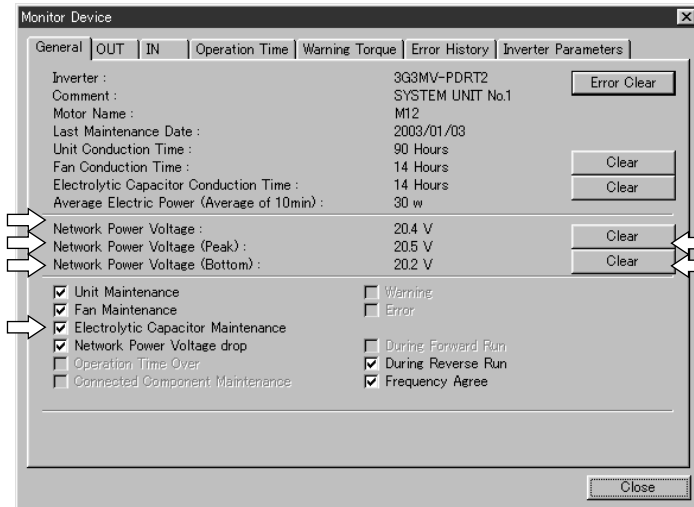

General Tab Page in the Monitor Device Window

The maximum and minimum values can be cleared.

Unit status report area

● **Using the Maintenance Information Window**

Click the **General** Tab in the Maintenance Information Window.

Note The differences from the Monitor Device Window are as follows:

- The voltage values shown in the Maintenance Information Window are when the maintenance information was refreshed and not the present values.
- The Clear Buttons for the peak and bottom values are not included in the Maintenance Information Window.

7-2-10 Unit Comment

■ **Function**

A user-defined name can be set for each Unit (up to 32 characters) and the names can be stored in the Slaves.

■ **Setting Methods**

1. Click the **General** Tab in the Edit Device Parameters Window.
2. Set the user-defined name (name of the device driving the Inverter, etc.) in the *Comment* field.

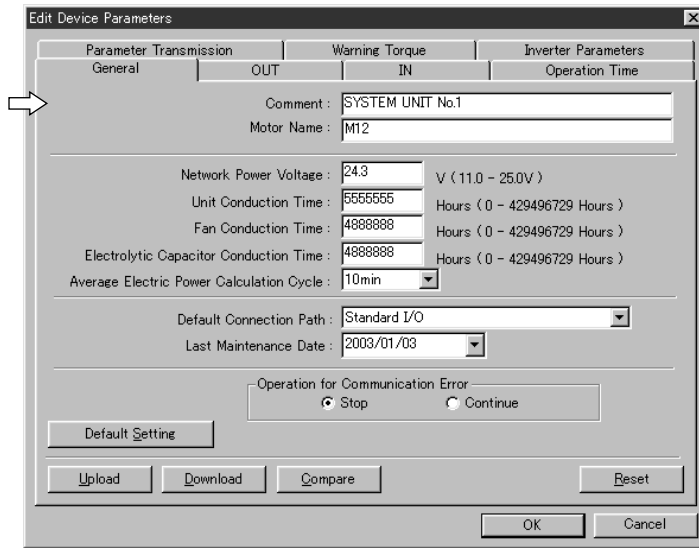

The General Tab Page in the Edit Device Parameters Window

■ Checking Methods

● Using the Monitor Device Window or Maintenance Information Window

Click the **General** Tab in the Monitor Device Window (or Maintenance Information Window). The set name (Unit comment) will be displayed in the *Comment* field.

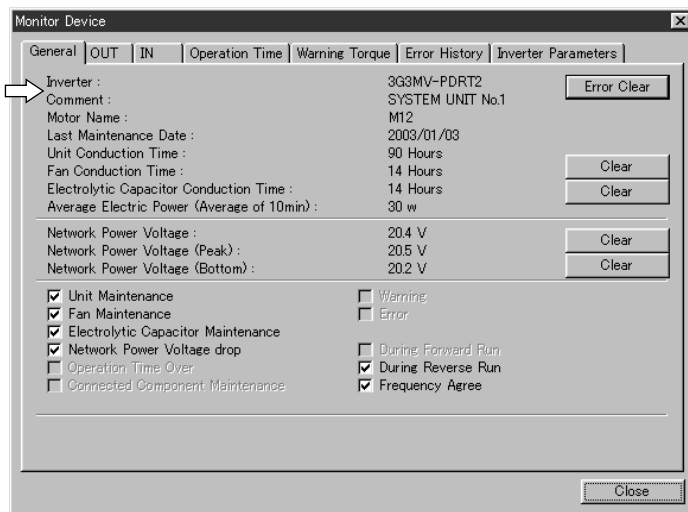

General Tab Page in the Monitor Device Window

7-2-11 Connected Device Comment

■ Function

- User-defined names can be set for the motor connected to the Inverter and devices connected to control I/O terminals, and those names can be stored in the Inverter.
- The devices connected to each of the I/O terminals can be checked, allowing the use of remote maintenance or other methods to identify errors in the connected devices.

- Names can be set using up to 32 characters.

■ Setting Methods

Set the connected device comments in the following tab pages.

- Motor name: General Tab Page of the Edit Device Parameters Window.
- Name of device connected to the output terminal (I/O comment): OUT Tab Page in the Edit Device Parameters Window.
- Name of device connected to the input terminal (I/O comment): IN Tab Page in the Edit Device Parameters Window.

● Setting the Motor Name

1. Click the **General** Tab in the Edit Device Parameters Window.
2. Set a user-defined name (such as the motor type or model) in the *Motor Name* field.

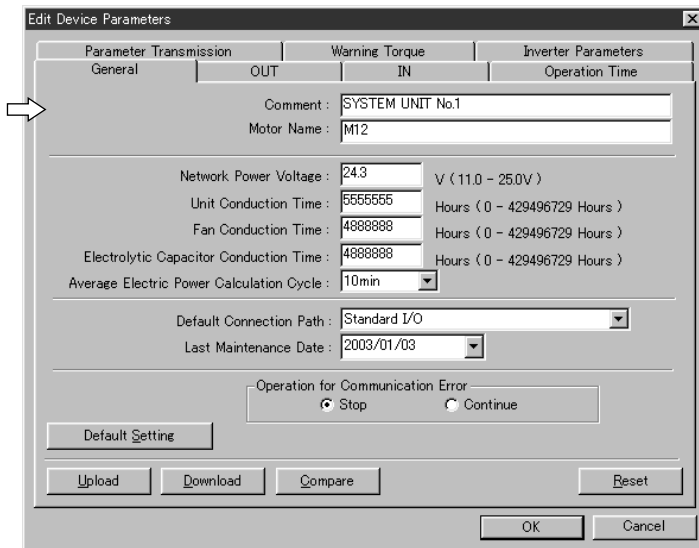

General Tab Page in the Monitor Device Window

● Setting the I/O Device Names

1. Click the **OUT** Tab in the Edit Device Parameters Window.
2. Set a user-defined name (output device name) in the *I/O Comment* field.
3. Click the **IN** Tab.
4. Set a user-defined name (input device name) in the *I/O Comment* field.

Note For details on the setting window, refer to *Setting Methods* under 7-2-6 *Cumulative ON Time Monitor*.

■ Checking Methods

Check the set connected device comments in the following tab pages.

- Motor name: *Motor Name* field on the General Tab Page of the Monitor Device Window (or Maintenance Information Window).

- Output device name: *I/O Comment* field on the OUT Tab Page of the Monitor Device Window (or Maintenance Information Window).
- Input device name: *I/O Comment* field on the IN Tab Page of the Monitor Device Window (or Maintenance Information Window).

7-2-12 Communications Error Log Monitor

■ Function

- The error status for the last four communications errors can be monitored.
- The communications error details, network power supply voltage at the time of the error, and Unit ON time are displayed.
- The communications error log can be cleared.

■ Monitoring Methods

● Using the Monitor Device Window

Click the **Error History** Tab in the Monitor Device Window.

- The details are displayed in the *Content*, *Network Power Voltage*, and *Unit Conduction Time* fields.

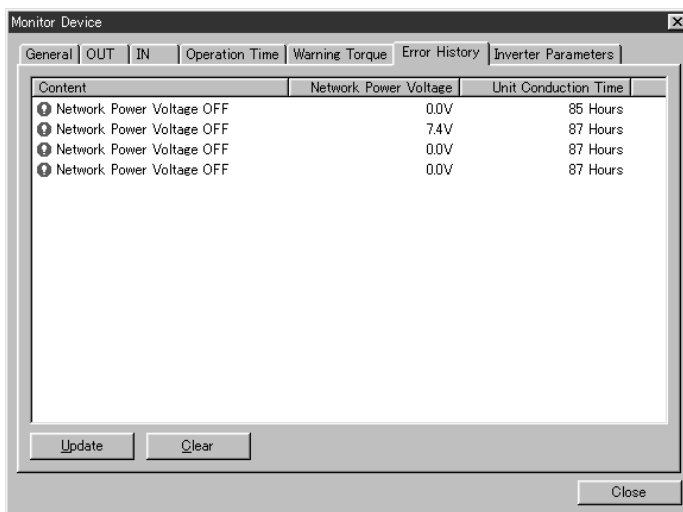

- Click the **Clear** Button to clear the communications error log.
- Click the **Update** Button to check whether a communications error has occurred and refresh the error log details.

Note If a new error occurs while the Error History Tab Page is being displayed, the error will not be displayed on the Error History Tab Page in real time. Click the **Update** Button to display the most recent error log.

● Using the Maintenance Information Window

Click the **Error History** Tab in the Maintenance Information Window.

Note The differences from the Monitor Device Window are as follows:

- The Update Button is not included in the Maintenance Information Window. (To update the error log, Click the **Update** Button on the **General** Tab Page.)

7-2-13 Last Maintenance Date

■ Function

- The date on which maintenance was last performed can be written to the Unit.
- The timing for future maintenance can be determined more easily.

■ Setting Methods

1. Click the **General** Tab in the Edit Device Parameters Window.
2. Select the desired date from the pull-down menu for the *Last Maintenance Date* field.

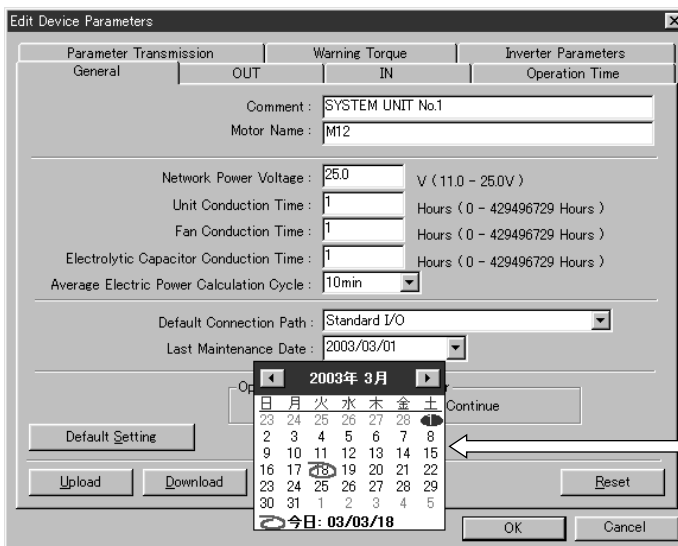

General Tab Page in the Edit Device Parameters Window

Click the date on the calendar to input the date.

To enter today's date, click **Today** at the bottom of the calendar.

■ Checking Methods

● Using the Monitor Device Window or Maintenance Information Window

Click the **General** Tab in the Monitor Device Window (or Maintenance Information Window). The set date will be displayed in the *Last Maintenance Date* field.

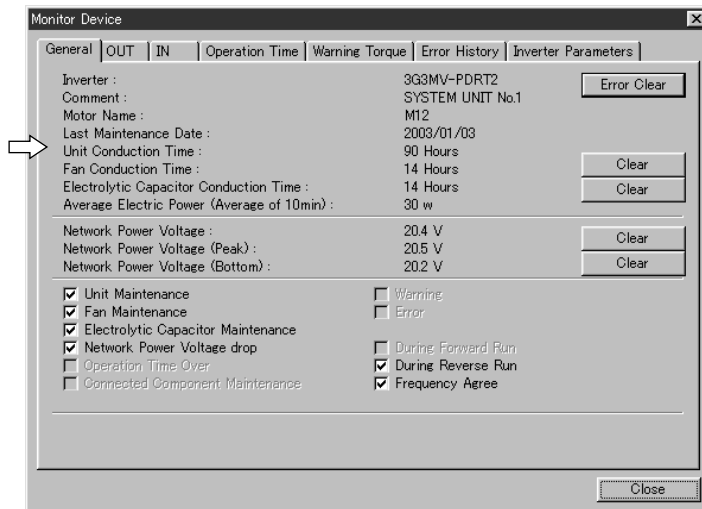

General Tab Page in the Monitor Device Window

7-2-14 Parameter Setting

■ Function

- The Inverter’s user parameters can be set with the Configurator.
- There are two ways to set the parameters, as follows:
 - Several of the major parameters can be displayed and set. (Inverter Parameters Tab Page)
 - An individual parameter’s Instance/Attribute can be specified and set. (Individual Parameters Tab Page)

Note 1. Some parameters cannot be set on the Inverter Parameters Tab Page settings. To change these parameters, set them separately on the Individual Parameters Tab Page.

Note 2. When the 3G3FV is used, some parameters cannot be set from the Configurator (parameters that cannot be changed using Class 64). Change these parameters using a Digital Operator.

■ Setting Method 1: Inverter Parameters Tab Page in the Edit Device Parameters Window

1. Click the **Inverter Parameters** Tab in the Edit Device Parameters Window.
2. Select the parameter group to be displayed from the pull-down menu in the *Parameter Group* field.

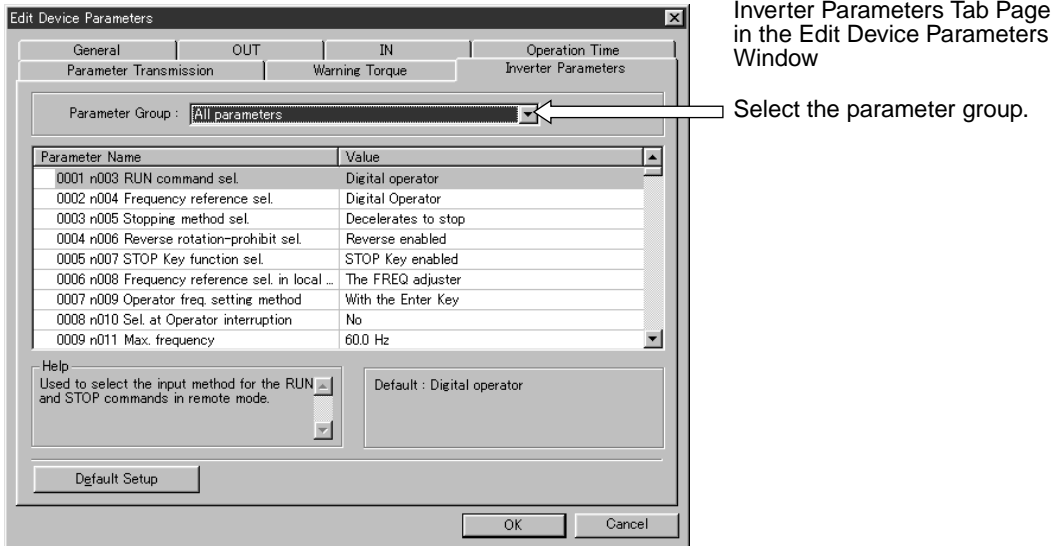

Note The displayed parameter groups are classified as shown in the table under *Parameter Groups and Parameters Not Set in Groups* on page 7-45. (The parameters that cannot be set depend on the Inverter series.)

Set the parameters that cannot be set on the Inverter Parameters Tab Page by using the Individual Parameters Tab Page. (The main parameters can be set on the Inverter Parameters Tab Page.) Use a Digital Operator to set the parameters that cannot be set from the Configurator.

3. The parameter number and name will be displayed in the *Parameter Name* field, and the parameter's set value is displayed in the *Value* field. Double-click the *Value* field of the parameter to be changed, and change the set value.

Note 1. Use either of the following two methods to set the parameter's set value.

- Select the set value from the pull-down menu.
- Input the numerical value.

Note 2. The details of the selected parameter are displayed in the *Help* Area. When setting the parameter, refer to the default value of the selected parameter that is displayed in the *Default* Area. For further details on the parameters, refer to the operation manual of the Inverter being used.

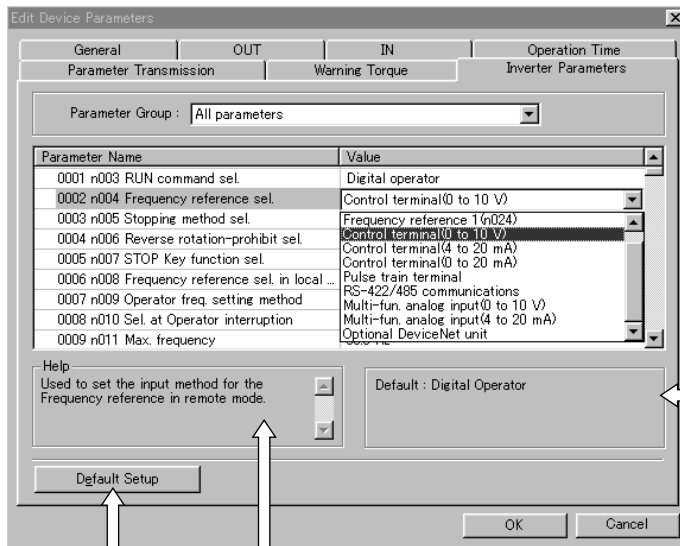

Inverter Parameters Tab Page in the Edit Device Parameters Window

Default value of the selected parameter

Details of the selected parameter

Click this button to return the set value of the selected parameter to the default value.

■ Setting Method 2: Individual Parameters Tab Page in the Edit Device Parameters Window

1. Click the **Individual Parameters** Tab in the Edit Device Parameters Window.

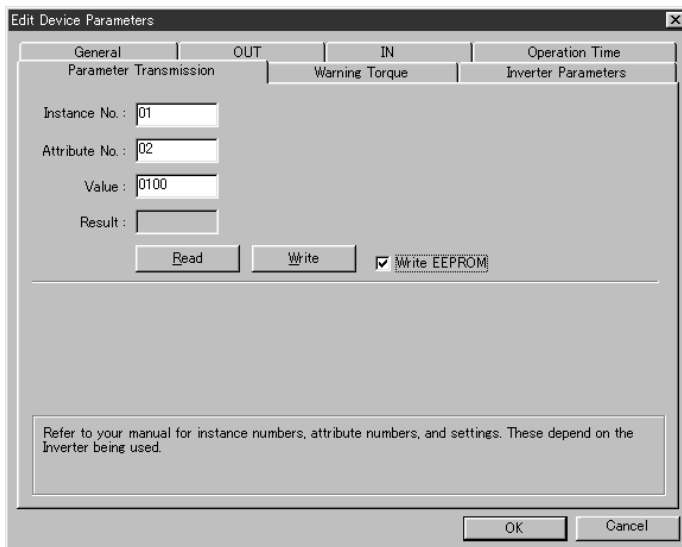

Individual Parameters Tab Page in the Edit Device Parameters Window

2. Set the Instance and Attribute of the parameter to be set in the *Instance No.* and *Attribute No.* fields.

Note Refer to the following sections for details on Instance/Attribute settings.

- 3G3MV: 10-4 3G3MV Register Numbers, Classes, Instances, and Attributes.
- 3G3RV: 10-5 3G3RV Register Numbers, Classes, Instances, and Attributes.
- 3G3PV: 10-6 3G3PV Register Numbers, Classes, Instances, and Attributes.
- 3G3FV: 10-7 3G3FV Register Numbers, Classes, Instances, and Attributes.

3. Enter the hexadecimal value to be set in the *Value* field.
4. To write the parameter set values to the Inverter's internal EEPROM (to restore the set values after a power interruption), select the *Write to EEPROM* field.
5. Click the **Write** Button to write the set value to the Inverter.

Note When the Read Button is clicked, the set value of the specified parameter (Instance/Attribute) is read from the Inverter and displayed as a hexadecimal in the *Result* field.

■ Parameter Groups and Parameters Not Set in Groups

● 3G3MV

Parameter Groups

Parameter group		Details
All Parameters	Function Group 1	n002 to n049
	Function Group 2	n050 to n079
	Function Group 3	n080 to n119
	Function Group 4	n120 to n179
	Function Group 5	ENTER command (Save to EEPROM)
	Function Group 6	Speed reference, speed monitor, current monitor, output voltage

Parameters that Cannot be Set on the Inverter Parameters Tab Page (Use the Individual Parameters Tab)

Parameter No.	Class 64		Details	
	Instance	Attribute		
n001	01	01	Parameter write-prohibit selection/parameter initialization	
n064	01	40	Frequency reference loss detection selection	
n087	01	57	Cumulative operation time selection	Can be set to 5.5 kW/7.5 kW only
n088	01	58	Cumulative operation time	
n101	01	65	Speed search deceleration time	
n102	01	66	Speed search level	
n151	01	97	RS-422 communications settings (These parameters are not used for DeviceNet, so they are not set.)	
n152	01	98		
n153	01	99		
n154	01	9A		
n155	01	9B		
n156	01	9C		
n157	01	9D		
n158	01	9E	Motor code (set value differs with capacity)	
n166	01	A6	Open input phase detection level	Can be set to 5.5 kW/7.5 kW only
n167	01	A7	Open input phase detection time	
n168	01	A8	Open output phase detection level	
n169	01	A9	Open output phase detection time	

Parameter No.	Class 64		Details
	Instance	Attribute	
n176	01	B0	Parameter copy and verify function selection (read only)
n177	01	B1	
n178	01	B2	Fault log

Note When the 3G3MV is used, all parameters can be set from the Configurator.

● 3G3RV/3G3PV

Parameter Groups

Parameter group	Details	
All Parameters	A: Initialize Mode Parameters	A: Environment settings
	B: Application Parameters	B: Application
	C: Tuning Parameters	C: Tuning
	D: Reference Parameters	D: Reference
	E: Motor Constant Parameters	E: Motor constant
	F: Option Parameters	F: Option
	H: Terminal Function Parameters	H: Terminal function setting
	L: Protection Function Parameters	L: Protection function
	N: Special Adjustments	N: Special adjustments
	O: Digital Operator Parameters	O: Operator
	Enter Code	Enter code
Monitor	Speed reference, speed monitor, current monitor, output voltage	

**Parameters that Cannot be Set on the Inverter Parameters Tab Page
(Use the Individual Parameters Tab Page)**

Parameter No.	Class 64		Details
	Instance	Attribute	
A1-00	01	00	Language selection for Digital Operator display
A1-01	01	01	Parameter access level
A1-04	01	04	Password
A1-05	01	05	Password setting
b4-01	01	A3	Timer function ON-delay time
b4-02	01	A4	Timer function OFF-delay time
C6-03	02	25	Carrier frequency upper limit
C6-04	02	26	Carrier frequency lower limit
C6-05	02	27	Carrier frequency proportional gain
E3	03	19 to 20	Motor 2 V/f pattern
E4	03	21 to 27	Motor 2 set values
H4-02	04	1E	Multi-function analog output 1 (terminal FM) output gain
H4-03	04	1F	Multi-function analog output 1 (terminal FM) bias
H4-05	04	21	Multi-function analog output 2 (terminal AM) output gain
H4-06	04	22	Multi-function analog output 2 (terminal AM) bias

Parameter No.	Class 64		Details
	Instance	Attribute	
H4-07	04	23	Multi-function analog output 1 (terminal FM) signal level selection
H4-08	04	27	Multi-function analog output 2 (terminal AM) signal level selection
o1-05	05	04	LCD brightness
o2-04	05	08	Inverter capacity selection

Note When the 3G3RV/3G3PV is used, all parameters can be set from the Configurator.

● 3G3FV

Parameter Group

Parameter group		Details
All Parameters	Initialize Mode Parameters	A: Environment settings (A1-02 only)
	Application Group	B: Application
	Tuning Parameters	C: Tuning
	Reference Parameters	D: Reference
	Motor Constant Parameters	E: Motor constant
	Option Parameter	F: Option
	Terminal Parameter	H: Terminal function setting
	Protection Parameter	L: Protection function
	Operator Parameter	O: Operator
	Enter Code	Enter code
	Monitor	Speed reference, speed monitor, current monitor, output voltage

**Parameters that Cannot be Set on the Inverter Parameters Tab Page
(Use the Individual Parameters Tab Page)**

Parameter No.	Class 64		Details
	Instance	Attribute	
C6-01	01	3D	Carrier frequency upper limit
C6-02	01	3E	Carrier frequency lower limit
C6-03	01	3F	Carrier frequency proportional gain

Parameters that Cannot Be Set from the Configurator (Use the Digital Operator)

	Parameter No.
A: Environment settings	All parameters except A1-02
B: Application	b1-06, b1-07, b1-08, b2-08, b4-01, b4-02, b5-09, b5-10, b5-11, b5-12, b5-13, and b5-14
C: Tuning	C1-10, C1-11, C3-06, C4-03, C4-04, C4-05, C8-09, and C8-30
E: Motor constant	E1-03, E2-10, E3-□□, E4-□□, and E5-□□
F: Option	F2-□□, F3-□□, F4-□□, F7-□□, and F9-□□
L: Protection function	L8-17 and L8-19

7-3 Edit Device Parameters Window

The settings for the DeviceNet Communications Unit/Card and connected Inverter are made in the Edit Device Parameters Window.

7-3-1 General Tab Page

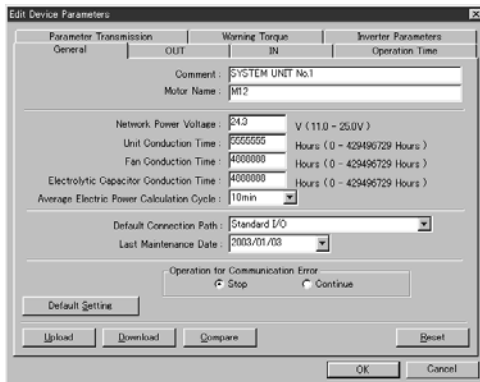

Item	Details	Reference
Comment	Set the name of the device.	7-2-10 Unit Comment
Motor Name	Set the name of the motor.	7-2-11 Connected Device Comment
Network Power Voltage	Set the monitor value for the network power supply voltage.	7-2-9 Network Power Supply Voltage Monitor
Unit Conduction Time	Set the monitor value for the Inverter's operating time.	7-2-8 Conduction Time Monitor
Fan Conduction Time	Set the monitor value for the fan's operating time.	
Electrolytic Capacitor Conduction Time	Set the monitor value for the electrolytic capacitor's operating time.	
Average Electric Power Calculation Cycle	Set the average power cycle.	7-2-2 Average Power Monitor Function
Default Connection Path	Set the type of remote I/O used.	5-1-2 Selecting the Remote I/O Function
Last Maintenance Date	Select the date that maintenance was last performed from the calendar.	7-2-13 Last Maintenance Date
Operation for Communications Error	Select whether the motor will stop or continue operating when a DeviceNet communications error occurs. Note: This setting is displayed for the 3G3MV only.	---
Default Setting Button	Returns the Communications Unit/Card internal settings except the Inverter parameters to the default values.	---
Upload Button	Reads all the data set in the Edit Device Parameters Window in a batch from the DeviceNet Communications Unit/Card.	7-2-1 Precautions when Operating the Edit Device Parameters Window
Download Button	Writes all the data set in the Edit Device Parameters Window in a batch to the DeviceNet Communications Unit/Card.	7-2-1 Precautions when Operating the Edit Device Parameters Window
Compare Button	Compares the set values in the Configurator with the set values in the Unit.	---
Reset Button	Performs a software reset (enables the set values written to the DeviceNet Communications Unit/Card).	7-2-1 Precautions when Operating the Edit Device Parameters Window
OK Button	Saves all the data set in the Edit Device Parameters Window and closes the Window.	---
Cancel Button	Cancel the changes made to settings in the Edit Device Parameters Window and closes the Window.	---

7-3-2 OUT Tab Page

Use the OUT Tab Page to make settings for multi-function outputs.

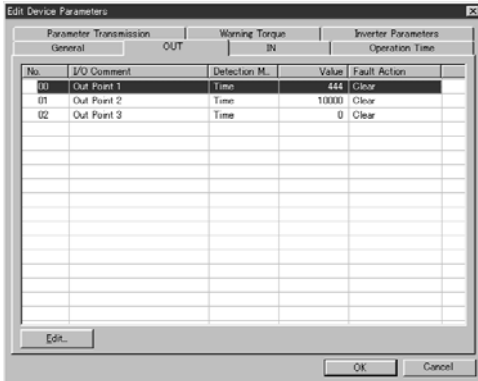

Double-click the selected field or click the **Edit** Button.

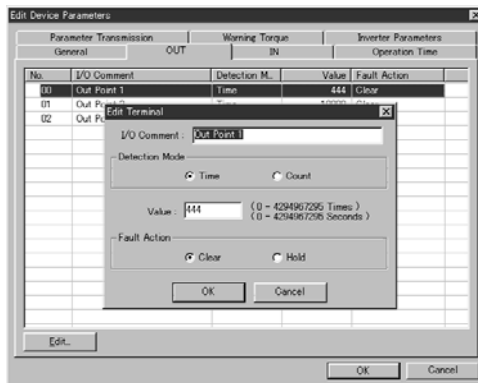

Item	Details	Reference
No.	The settings in the <i>No.</i> field are as follows: 00: Multi-function contact output, 01: Multi-function output 1, 02: Multi-function output 2	---
I/O Comment	Set a user-defined name for each terminal.	7-2-11 <i>Connected Device Comment</i>
Detection Mode	Set the detection mode to either Cumulative ON Time or Contact Operations Counter. Note: When the setting is made in the setting window, the setting will be displayed in the <i>Detection Mode</i> field.	7-2-6 <i>Cumulative ON Time Monitor</i> 7-2-7 <i>Contact Operations Monitor</i>
Value	Set the monitor value (time or count). Note: When the setting is made in the setting window, the setting will be displayed in the <i>Value</i> field.	
Fault Action	Set the status of the output terminal when a communications error occurs. Note: When the setting is made in the setting window, the setting will be displayed in the <i>Fault Action</i> field.	---

7-3-3 IN Tab Page

Use the IN Tab Page to make settings for input terminals.

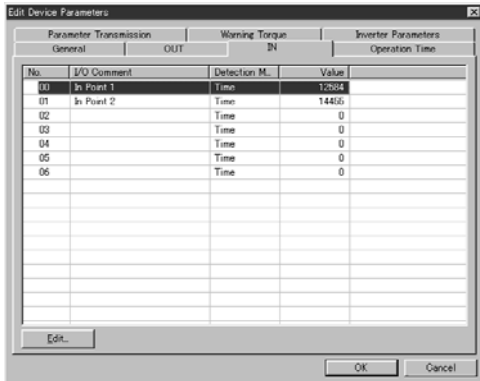

Double-click the selected field or click the **Edit** Button.

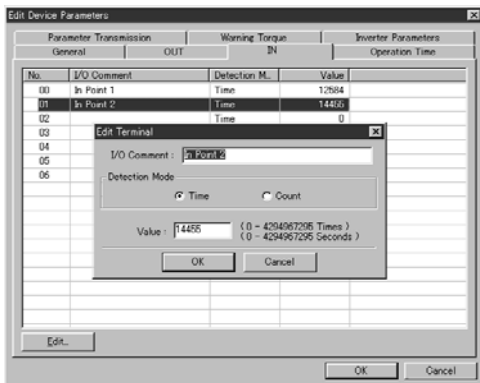

Item		Reference
No.	Refer to the following tables.	---
I/O Comment	Set a user-defined name for each terminal. Note: When the setting is made in the setting window, the setting will be displayed in the <i>I/O Comment</i> field.	7-2-11 <i>Connected Device Comment</i>
Detection Mode	Set the detection mode to either Cumulative ON Time or Contact Operations Counter. Note: When the setting is made in the setting window, the setting will be displayed in the <i>Detection Mode</i> field.	7-2-6 <i>Cumulative ON Time Monitor</i> 7-2-7 <i>Contact Operations Monitor</i>
Value	Set the monitor value (time or count). Note: When the setting is made in the setting window, the setting will be displayed in the <i>Value</i> field.	

Note The following tables show the meanings of the numerals set in the *No.* field.

No.	Details		
	3G3MV	3G3RV/3G3PV	3G3FV
00	Multi-function input 1	Forward/stop	Forward/stop
01	Multi-function input 2	Reverse/stop	Reverse/stop
02	Multi-function input 3	Multi-function input selection 1	Multi-function contact input 1
03	Multi-function input 4	Multi-function input selection 2	Multi-function contact input 2
04	Multi-function input 5	Multi-function input selection 3	Multi-function contact input 3
05	Multi-function input 6	Multi-function input selection 4	Multi-function contact input 4
06	Multi-function input 7	Multi-function input selection 5	Multi-function contact input 5
07			Multi-function contact input 6

7-3-4 Operation Time Tab Page

The Operation Time Tab Page is used to make the settings for the operation time monitor function.

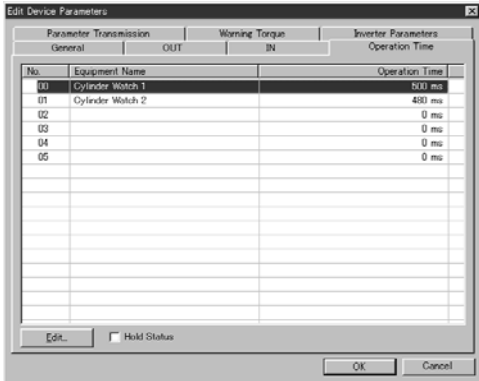

↓ Double-click the selected field or click the **Edit** Button.

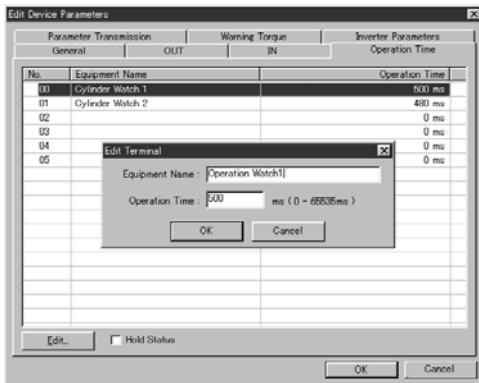

Item	Details	Reference
No.	Refer to the following table. (For details, refer to 7-2-5 <i>Operating Time Monitor Function</i> .)	7-2-5 <i>Operating Time Monitor Function</i>
Equipment Name	Set a user-defined name for each device. Note: When the setting is made in the setting window, the setting will be displayed in the <i>Equipment Name</i> field.	
Operation Time	Set the monitor value. Note: When the setting is made in the setting window, the setting will be displayed in the <i>Operation Time</i> field.	
Hold Status	Set whether to maintain the ON Unit status when the monitor value is exceeded.	

Note The following table shows the meanings of the values set in the *No.* field.

No.		
00	Multi-function contact output: ON	Input 4: ON
01	Multi-function output 1: ON	Input 5: ON
02	Input 2: ON	Input 3: ON
03	Input 4: ON	Input 5: ON
04	Input 0: ON or Input 1: ON or when a forward/reverse run command is sent	Input 4: ON
05	Input 0: ON or Input 1: ON or when a forward/reverse run command is sent	Input 5: ON

7-3-5 Individual Parameters Tab Page

Use this tab page to set parameters that cannot be set on the Inverter Parameters Tab Page, or to set individual parameters.

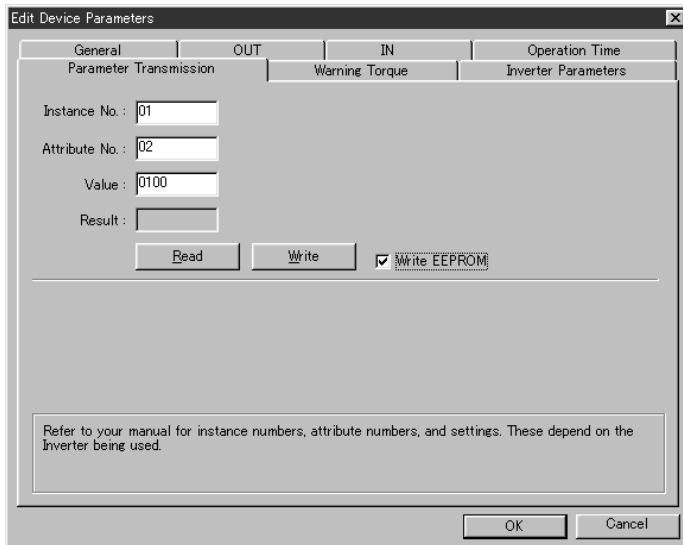

Item	Details	Reference
Instance No., Attribute No., and Value	Set the Instance/Attribute and set value for the parameter to be changed. Set the value in hexadecimal.	7-2-14 Parameter Setting
Result	Displays the read result in hexadecimal.	
Read Button	Reads the set values of the specified parameter (Instance/Attribute) from the Inverter.	
Write Button	Writes the set parameters to the Inverter. Note: An error message is displayed when a write error occurs.	
Write to EEPROM	To save the parameter set values in the Inverter even after a power interruption, select this item before clicking the Write Button.	

7-3-6 Warning Torque Tab Page

Use this tab page to make the settings for warning torque detection.

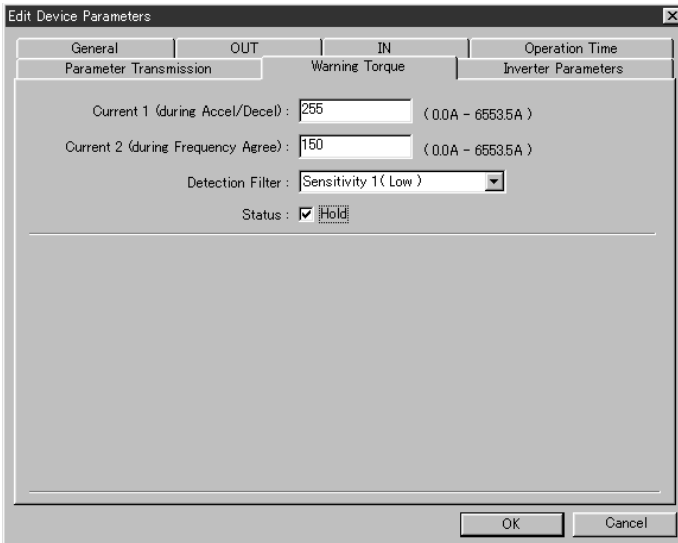

Item	Details	Reference
Current 1 (during Accel/Decel)	Set the threshold used to monitor the current level during acceleration or deceleration. Note: When this value is set to 0.0 (A), the current is not monitored during acceleration or deceleration.	7-2-3 Warning Torque Detection
Current 2 (during Frequency Agree)	Set the threshold used to monitor the current level during frequency agreement (while operating at constant speed). Note: When this value is set to 0.0 (A), the current is not monitored during frequency agreement.	
Detection Filter	Select the level of detection sensitivity from <i>Sensitivity 1 (Low)</i> to <i>Sensitivity 5 (High)</i> in the pull-down menu.	
Status	Set whether to maintain the ON status in the Unit's Status Area (Warning Torque Detection Flag) when the current exceeds either of the thresholds set for <i>Current 1</i> and <i>Current 2</i> .	

7-3-7 Inverter Parameters Tab Page

Use this tab page to set the main parameters for the Inverter being used.

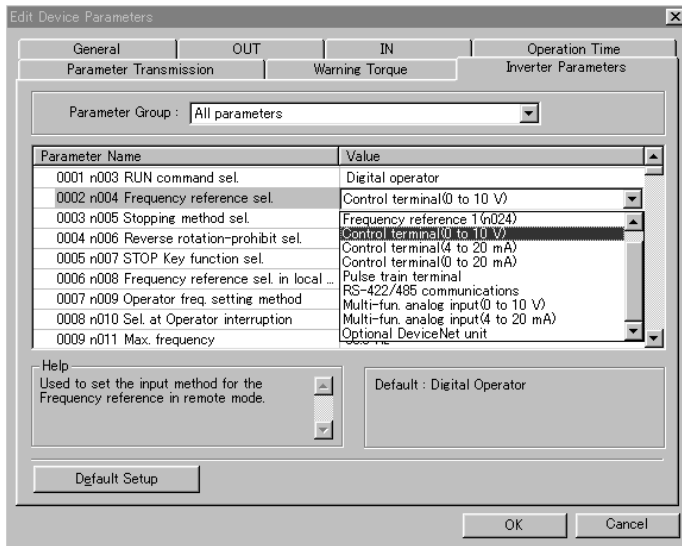

Item	Details	Reference
Parameter Group	Select the parameter group to be displayed from the pull-down menu.	7-2-14 Parameter Setting
Parameter Name	Displays the number and name of the parameters included in the selected parameter group.	
Value	Displays the parameter's set value. Note: The two setting methods are as follows (depends on the parameter) <ul style="list-style-type: none"> • Select the set value from the pull-down menu. • Enter the numerical value. 	
Help	Displays the details of the selected parameter.	
Default	Displays the factory setting of the selected parameter.	
Default Setup Button	Returns the set value of the selected parameter to its factory setting.	

7-4 Monitor Device Window

The functions set in the Edit Device Parameters Window are monitored from the Monitor Device Window.

7-4-1 General Tab Page

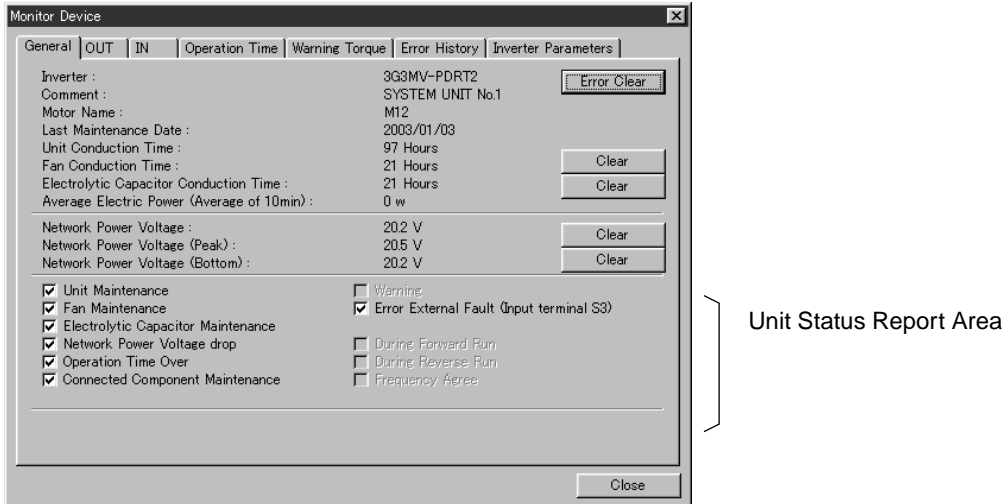

Item	Details	Reference
Inverter	Displays the name of the mounted Inverter.	---
Comment	Displays the name of the device.	7-2-10 Unit Comment
Motor Name	Displays the motor name.	7-2-11 Connected Device Comment
Last Maintenance Date	Displays the last date that maintenance was performed.	7-2-13 Last Maintenance Date
Unit Conduction Time	Displays the operating time of the Inverter's Main Unit.	7-2-8 Conduction Time Monitor
Fan Conduction Time	Displays the operating time of the fan. Note: This setting can be cleared to zero by clicking the Clear Button at the right of the item.	
Electrolytic Capacitor Conduction Time	Displays the operating time of the electrolytic capacitor. Note: This setting can be cleared to zero by clicking the Clear Button at the right of the item.	
Average Electric Power	Displays the calculated value of the average power.	7-2-2 Average Power Monitor Function

Item		Details	Reference
Network Power Voltage		Displays the present value for the network power voltage.	<i>7-2-9 Network Power Supply Voltage Monitor</i>
Network Power Voltage (Peak)		Displays the maximum value for the network power voltage. Note: This setting can be cleared to zero by clicking the Clear Button at the right of the item.	
Network Power Voltage (Bottom)		Displays the minimum value for the network power voltage. Note: This setting can be cleared to zero by clicking the Clear Button at the right of the item.	
Error Clear Button		Clears the error at the Inverter.	---
Unit Status Report Area	Unit Maintenance	Notifies that the Inverter's operation time has exceeded the monitor value.	<i>7-2-8 Conduction Time Monitor</i>
	Fan Maintenance	Notifies that the fan's operation time has exceeded the monitor value.	
	Electrolytic Capacitor Maintenance	Notifies that the electrolytic capacitor's operation time has exceeded the monitor value.	
	Network Power Voltage Drop	Notifies that the network power voltage has dropped below the monitor value.	<i>7-2-9 Network Power Supply Voltage Monitor</i>
	Operation Time Over	Notifies that the operation time has exceeded the monitor value.	<i>7-2-5 Operating Time Monitor Function</i>
	Connected Component Maintenance	Notifies that the total ON time or contact operations count for the I/O terminals has exceeded the monitor value.	<i>7-2-6 Cumulative ON Time Monitor</i> <i>7-2-7 Contact Operations Monitor</i>
	Warning	Notifies that a warning or error has occurred in the Inverter (the details are also displayed.)	---
	During Forward Run and During Reverse Run	Notify that the Inverter is operating in forward/reverse run.	---
	Frequency Agree	Notifies that the Inverter is agreement frequencies.	---

7-4-2 OUT Tab Page

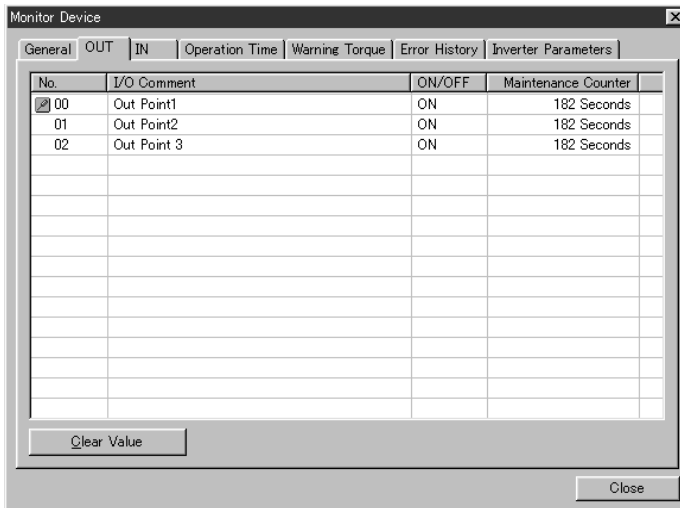

Item	Details	Reference
No.	The settings in the <i>No.</i> field are as follows: 00: Multi-function contact output, 01: Multi-function output 1, 02: Multi-function output 2 Note: When the present value for the maintenance counter (cumulative ON time or contact operations count) exceeds the monitor value, an error icon will be displayed to the left of the corresponding <i>No.</i> setting (No. 01 in the above screen example).	---
I/O Comment	Displays the user-defined connected device comment for each output terminal.	7-2-11 <i>Connected Device Comment</i>
ON/OFF	Displays the ON/OFF status for each output terminal.	---
Maintenance Counter	Displays the present value of the maintenance counter for each output terminal. Note: Displays the cumulative ON time (in seconds) or the contact operations count (number of times).	7-2-6 <i>Cumulative ON Time Monitor</i> 7-2-7 <i>Contact Operations Monitor</i>
Clear Value Button	Clears the present value of the maintenance counter to zero. Note: Select the terminal to be cleared, and click the Clear Button to clear the value to zero.	

7-4-3 IN Tab Page

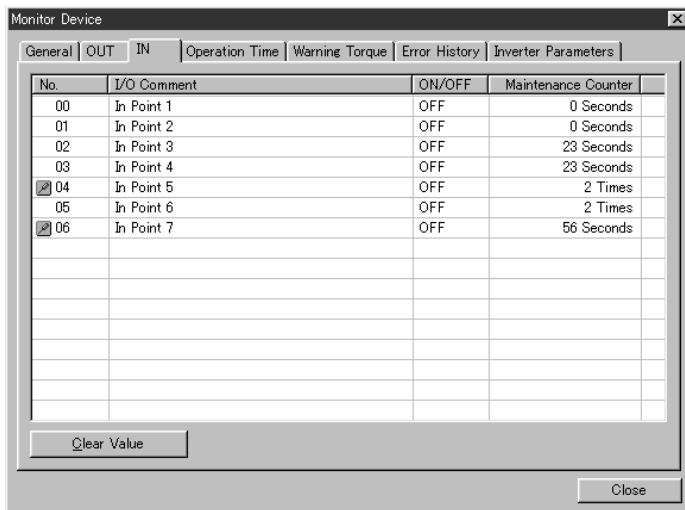

Item		Reference
No.	Refer to the following table for meanings in the <i>No.</i> field. Note: When the present value for the maintenance counter (cumulative ON time or contact operations count) exceeds the monitor value, an error icon will be displayed to the left of the corresponding <i>No.</i> setting (No. 05 in the above screen example).	---
I/O Comment	Displays the user-defined connected device comment for each input terminal.	7-2-11 <i>Connected Device Comment</i>
ON/OFF	Displays the ON/OFF status for each input terminal.	---
Maintenance Counter	Displays the present value of the maintenance counter for each input terminal. Note: Displays the cumulative ON time (in seconds) or the contact operations count (number of times).	7-2-6 <i>Cumulative ON Time Monitor</i> 7-2-7 <i>Contact Operations Monitor</i>
Clear Value Button	Clears the present value of the maintenance counter to zero. Note: Select the terminal to be cleared, and click the Clear Button to clear the value to zero.	

Note The following table shows the meanings of the values set in the *No.* field

No.	Details		
	3G3MV	3G3RV/3G3PV	3G3FV
00	Multi-function input 1	Forward/stop	Forward/stop
01	Multi-function input 2	Reverse/stop	Reverse/stop
02	Multi-function input 3	Multi-function input selection 1	Multi-function contact input 1
03	Multi-function input 4	Multi-function input selection 2	Multi-function contact input 2
04	Multi-function input 5	Multi-function input selection 3	Multi-function contact input 3
05	Multi-function input 6	Multi-function input selection 4	Multi-function contact input 4
06	Multi-function input 7	Multi-function input selection 5	Multi-function contact input 5
07			Multi-function contact input 6

7-4-4 Operation Time Tab Page

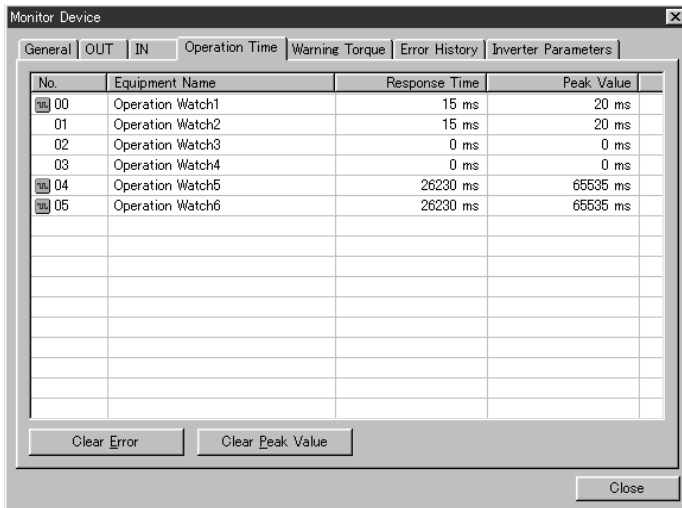

Item	Details	Reference
No.	Refer to the following table for meanings in the No. field. (For details, refer to 7-2-5 Operating Time Monitor Function.) Note: When the operating time exceeds the monitor value, an error icon is displayed to the left of the corresponding setting in the No. field.	7-2-5 Operating Time Monitor Function
Equipment Name	Displays the name of each device.	
Response Time	Displays the operating time of each device.	
Peak Value	Displays the maximum value of the operating time of each device.	
Clear Error Button	Clears the Operation Time Over Flag in the Unit's Status Area. Note 1: This button is enabled when Status Hold is selected on the Operation Time Tab Page of the Edit Device Parameters Window. Note 2: Select the device to be cleared, and then click the Clear Error Button to set the Flag to OFF.	
Clear Peak Value Button	Clears the peak operating time value to zero. Note: Select the device to be cleared, and then click the Clear Peak Button to clear the setting to zero.	

Note The following table shows the meanings of the values set in the No. field]

No.	Operating time measurement trigger	
	Conditions for starting measurement	Conditions for ending measurement
00	Multi-function contact output: ON	Input 4: ON
01	Multi-function output 1: ON	Input 5: ON
02	Input 2: ON	Input 3: ON
03	Input 4: ON	Input 5: ON
04	Input 0: ON or Input 1: ON or when a forward/reverse run command is sent	Input 4: ON
05	Input 0: ON or Input 1: ON or when a forward/reverse run command is sent	Input 5: ON

Note For details on measurement methods, refer to 7-2-5 Operating Time Monitor Function.

7-4-5 Warning Torque Tab Page

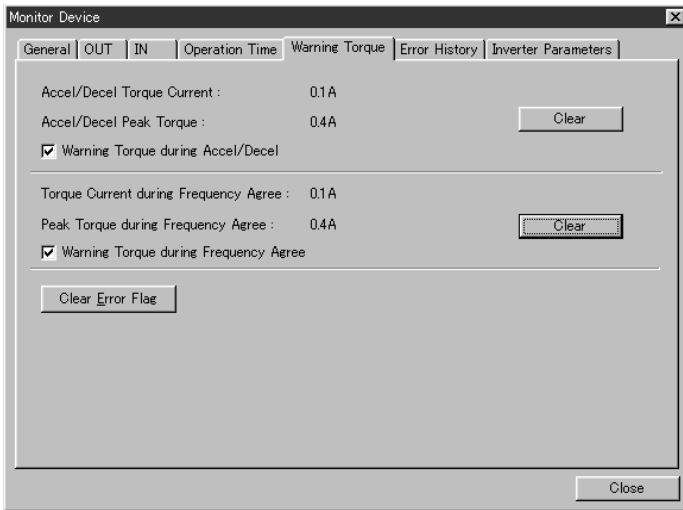

Item	Details	Reference
Accel/Decel Torque Current	Displays the current level during acceleration/deceleration. Note: The present value or most recent value is displayed.	7-2-3 Warning Torque Detection
Accel/Decel Peak Torque	Displays the maximum current level during acceleration/deceleration. Note: The setting can be cleared to zero by clicking the Clear Button to the right of the setting.	
Warning Torque during Accel/Decel	Displays this item as selected when the current level exceeds the monitor value (threshold) during acceleration/deceleration.	
Torque Current during Frequency Agree	Displays the current level during frequency agreement. Note: The present value or most recent value is displayed.	
Peak Torque during Frequency Agree	Displays the maximum current level during frequency agreement. Note: The setting can be cleared to zero by clicking the Clear Button to the right of the setting.	
Warning Torque during Frequency Agree	Displays this item as selected when the current level exceeds the monitor value (threshold) during frequency agreement.	
Clear Error Flag Button	Clears the Warning Torque Detection Flag in the Unit's Status Area. Note 1: This button is enabled when the <i>Status Hold</i> field is selected on the Warning Torque Tab Page of the Edit Device Parameters Window.	

7-4-6 Error History Tab Page

This tab page is used to display the error history for the last four communications errors communications.

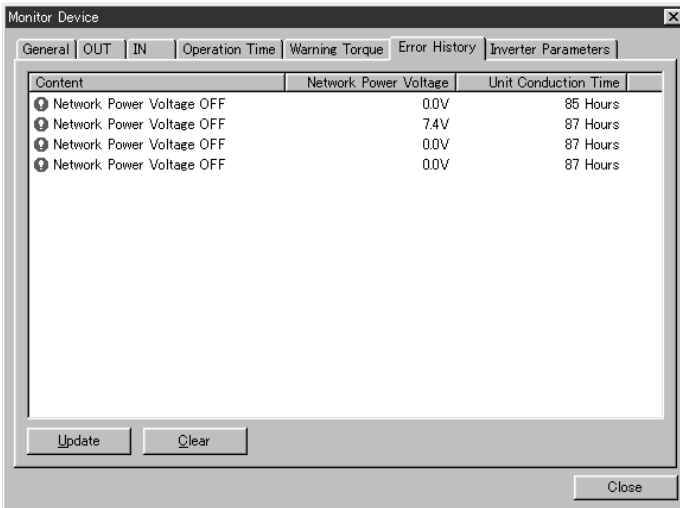

Item	Details	Reference
Content	Displays the details of the errors that have occurred. Note: The most recent error is displayed at the bottom of the list.	<i>7-2-12 Communications Error Log Monitor</i>
Network Power Voltage	Displays the network power supply voltage from when the error occurred.	
Unit Conduction Time	Displays the Unit ON time from when the error occurred.	
Update Button	Displays the most recent error log. Note: If a new error occurs while the error log is being displayed, the error will not be displayed on the Error History Tab Page in real time. Click the Update Button to display the most recent error log.	
Clear Button	Clears the error log.	

7-4-7 Inverter Parameters Tab Page

Use this tab page to monitor the following four types of information in the Inverter.

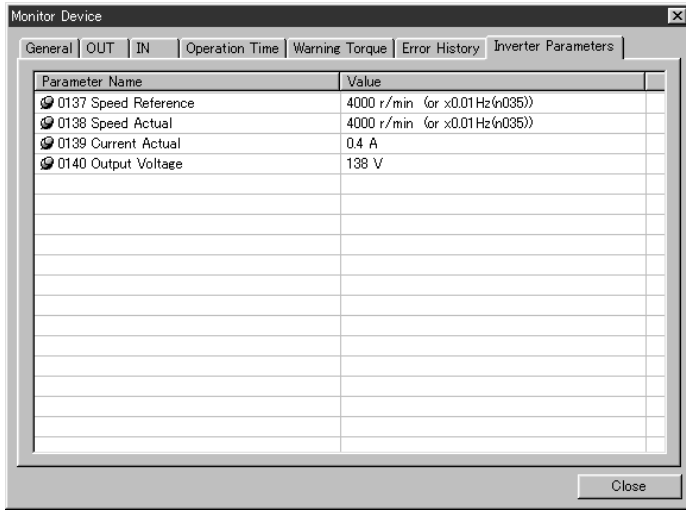

Item	Details	Reference
Speed Reference	Displays the frequency reference value in r/min. (See note.)	---
Speed Actual	Displays the output frequency in r/min. (See note.)	
Current Actual	Displays the output current level.	
Output Voltage	Displays the output voltage level (Inverter's internal output voltage reference value).	

Note The unit for the frequency reference value and output frequency are determined according to the set values for the [n035/o1-03] parameter (frequency reference setting and display units). When the number of motor poles (2 to 39) is set in this parameter, the r/min unit is used. When the factory setting "0" is used, the x0.01 Hz is used as the unit.

7-5 Maintenance Information Window

7-5-1 General Tab Page

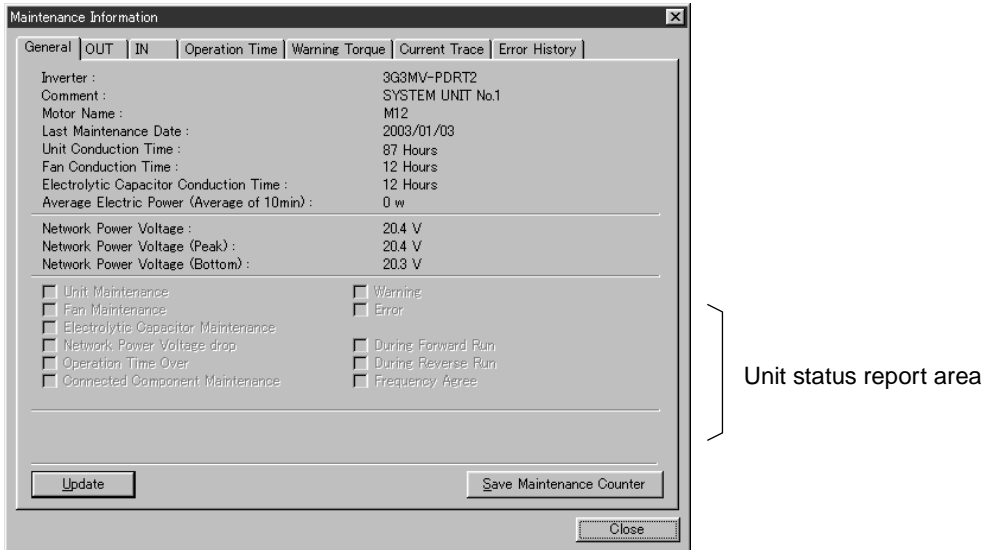

Item	Details	Reference
Inverter	Displays the name of the mounted Inverter.	---
Comment	Displays the name of the device.	7-2-10 Unit Comment
Motor Name	Displays the motor name.	7-2-11 Connected Device Comment
Last Maintenance Date	Displays the last date that maintenance was performed.	7-2-13 Last Maintenance Date
Unit Conduction Time	Displays the operating time of the Inverter's Main Unit.	7-2-8 Conduction Time Monitor
Fan Conduction Time	Displays the operating time of the fan. Note: This setting can be cleared to zero by clicking the Clear Button at the right of the item.	
Electrolytic Capacitor Conduction Time	Displays the operating time of the electrolytic capacitor.	
Average Electric Power	Displays the calculated value of the average power.	7-2-2 Average Power Monitor Function
Network Power Voltage	Displays the present value for the network power voltage.	7-2-9 Network Power Supply Voltage Monitor
Network Power Voltage (Peak)	Displays the maximum value for the network power voltage.	
Network Power Voltage (Bottom)	Displays the minimum value for the network power voltage.	

Item		Details	Reference
Unit Status Report Area	Unit Maintenance	Notifies that the Inverter's operation time has exceeded the monitor value.	7-2-8 Conduction Time Monitor
	Fan Maintenance	Notifies that the fan's operation time has exceeded the monitor value.	
	Electrolytic Capacitor Maintenance	Notifies that the electrolytic capacitor's operation time has exceeded the monitor value.	
	Network Power Voltage Drop	Notifies that the network power voltage has dropped below the monitor value.	7-2-9 Network Power Supply Voltage Monitor
	Operation Time Over	Notifies that the operation time has exceeded the monitor value.	7-2-5 Operating Time Monitor Function
	Connected Component Maintenance	Notifies that the total ON time or contact operations count for the I/O terminals has exceeded the monitor value.	7-2-6 Cumulative ON Time Monitor 7-2-7 Contact Operations Monitor
	Warning	Notifies that a warning or error has occurred in the Inverter (the details are also displayed).	---
	During Forward Run/During Reverse Run	Notifies that the Inverter is operating in forward/reverse run mode.	---
	Frequency Agree	Notifies that the Inverter is agreement frequencies.	---
Update Button		Uploads all the maintenance information (including information from other tab pages) and refreshes the screen.	---
Save Maintenance Counter Button		Writes the maintenance counter information (operating time and maintenance counter for each terminal) to the EEPROM of the DeviceNet Communications Unit/Card.	---

Note The maintenance information is saved in the EEPROM approximately every six minutes. Therefore, depending on the power OFF timing, up to six minutes worth of data is lost. To monitor more closely, click the **Save Maintenance Counter** Button immediately before turning OFF the power. The maintenance information will be written to the EEPROM.

7-5-2 OUT Tab Page

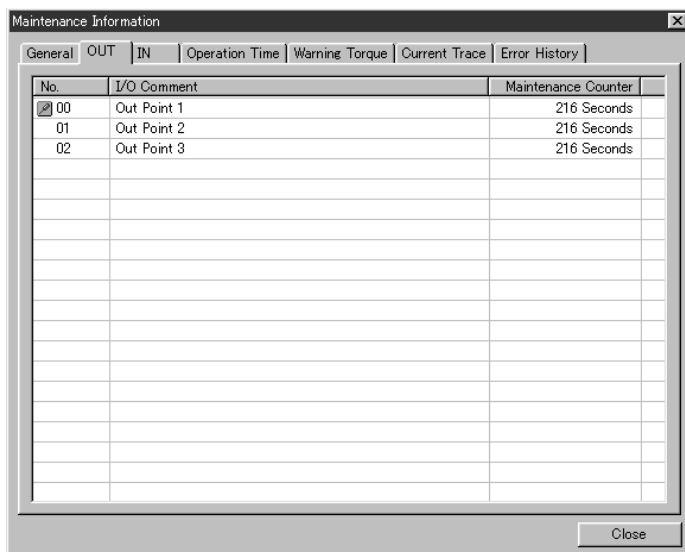

Item	Details	Reference
No.	<p>The settings in the <i>No.</i> field are as follows: 00: Multi-function contact output, 01: Multi-function output 1, 02: Multi-function output 2</p> <p>Note: When the present value for the maintenance counter (cumulative ON time or contact operations count) exceeds the monitor value, an error icon will be displayed to the left of the corresponding <i>No.</i> setting (No. 01 in the above screen example).</p>	---
I/O Comment	Displays the user-defined connected device comment for each output terminal.	7-2-11 <i>Connected Device Comment</i>
Maintenance Counter	<p>Displays the present value of the maintenance counter for each output terminal.</p> <p>Note: The cumulative ON time (in seconds) or the contact operations count (number of times) is displayed.</p>	7-2-6 <i>Cumulative ON Time Monitor</i> 7-2-7 <i>Contact Operations Monitor</i>

7-5-3 IN Tab Page

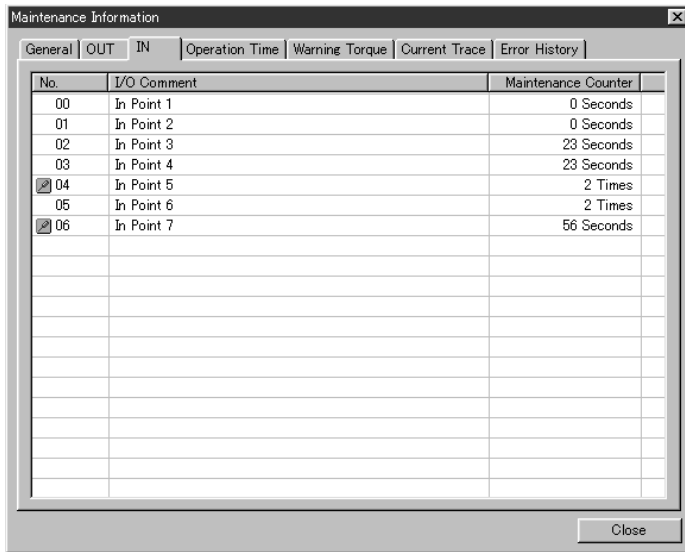

Item	Details	Reference
No.	Refer to the following table for meanings in the <i>No.</i> field. Note: When the present value for the maintenance counter (cumulative ON time or contact operations count) exceeds the monitor value, an error icon will be displayed to the left of the corresponding No. setting (No. 05 in the above screen example).	---
I/O Comment	Displays the user-defined connected device comment for each input terminal.	7-2-11 <i>Connected Device Comment</i>
Maintenance Counter	Displays the present value of the maintenance counter for each input terminal. Note: The cumulative ON time (in seconds) or the contact operations count (number of times) is displayed.	7-2-6 <i>Cumulative ON Time Monitor</i> 7-2-7 <i>Contact Operations Monitor</i>

Note The following table shows the meanings of the values set in the *No.* field

No.	Details		
	3G3MV	3G3RV/3G3PV	3G3FV
00	Multi-function input 1	Forward/stop	Forward/stop
01	Multi-function input 2	Reverse/stop	Reverse/stop
02	Multi-function input 3	Multi-function input selection 1	Multi-function contact input 1
03	Multi-function input 4	Multi-function input selection 2	Multi-function contact input 2
04	Multi-function input 5	Multi-function input selection 3	Multi-function contact input 3
05	Multi-function input 6	Multi-function input selection 4	Multi-function contact input 4
06	Multi-function input 7	Multi-function input selection 5	Multi-function contact input 5
07			Multi-function contact input 6

7-5-4 Operation Time Tab Page

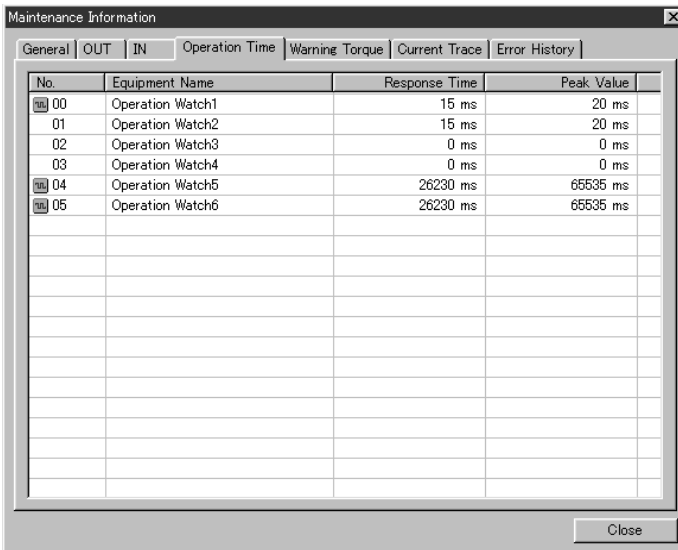

Item	Details	Reference
No.	Refer to the following table for meanings in the No. field. (For details, refer to 7-2-5 Operating Time Monitor Function.) Note: When the operating time exceeds the monitor value, an error icon is displayed to the left of the corresponding setting in the No. field.	7-2-5 Operating Time Monitor Function
Equipment Name	Displays the name of each device.	
Response Time	Displays the operating time of each device.	
Peak Value	Displays the maximum value of the operating time of each device.	

Note The following table shows the meanings of the values set in the No. field

No.	Operating time measurement trigger	
	Conditions for starting measurement	Conditions for ending measurement
00	Multi-function contact output: ON	Input 4: ON
01	Multi-function output 1: ON	Input 5: ON
02	Input 2: ON	Input 3: ON
03	Input 4: ON	Input 5: ON
04	Input 0: ON or Input 1: ON or when a forward/reverse run command is sent	Input 4: ON
05	Input 0: ON or Input 1: ON or when a forward/reverse run command is sent	Input 5: ON

7-5-5 Warning Torque Tab Page

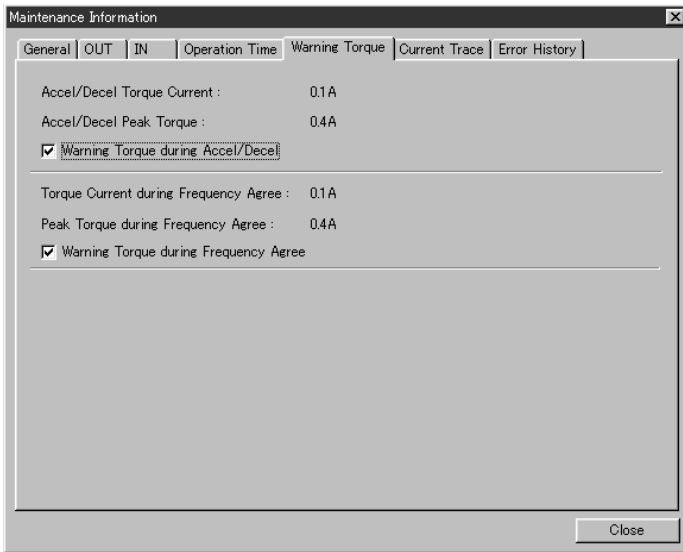

Item	Details	Reference
Accel/Decel Torque Current	Displays the current level during acceleration/deceleration. Note: The value when the maintenance information was refreshed is displayed.	7-2-3 Warning Torque Detection
Accel/Decel Peak Torque	Displays the maximum current level during acceleration/deceleration.	
Warning Torque during Accel/Decel	Displays this item as selected when the current level exceeds the monitor value (threshold) during acceleration/deceleration.	
Torque Current Level during Frequency Agree	Displays the current level during frequency agreement. Note: The value when the maintenance information was refreshed is displayed.	
Peak Torque during Frequency Agree	Displays the maximum current level during frequency agreement.	
Warning Torque during Frequency Agree	Displays this item as selected when the current level exceeds the monitor value (threshold) during frequency agreement.	

7-5-6 Current Trace Tab Page

History Tab Page

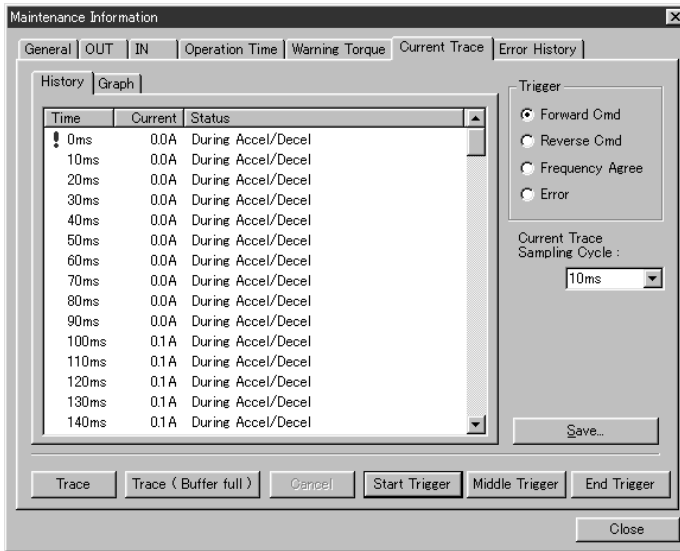

Item	Details	Reference
Time	Displays the time determined from the current trace sampling cycle.	7-2-4 Current Trace
Current	Displays all the traced current levels for every sampling cycle.	
Status	Displays whether the sampling timing is during acceleration/deceleration or frequency agreement.	
Trigger	Set the signal used for trace timing. Note: The trace is performed using the trigger setting combined with the Start Trigger Button, Middle Trigger Button, and End Trigger Button.	
Current Trace Sampling Cycle	Select the trace sampling cycle from the pull-down menu. Note: The cycle can be set to 10 ms, 20 ms, 50 ms, 100 ms, up to 100 s.	
Trace Button	Starts the trace. Note: The trace will continue until the Cancel Button is clicked. The 150 points sampled immediately before the Cancel Button is clicked will be stored.	
Trace (Buffer Full) Button	Starts a trace that will stop when 150 points are sampled. Note: The trace will also stop if the Cancel Button is clicked during the trace.	
Cancel Button	Stops the trace.	
Start Trigger Button	The trace stops when 150 points have been sampled using the trigger signal selected in the <i>Trigger</i> field. Note: The trace will also stop if the Cancel Button is clicked during the trace.	
Middle Trigger Button	Starts a trace that will stop when 75 points have been sampled using the trigger signal selected in the <i>Trigger</i> field. Note 1: The 75 points from immediately before and after the trigger are sampled. Note 2: The trace will also stop if the Cancel Button is clicked during the trace.	
End Trigger Button	Starts a trace that stops at the trigger signal selected in the <i>Trigger</i> field. Note 1: The 150 points from immediately before the trigger are sampled. Note 2: The trace will also stop if the Cancel Button is clicked during the trace.	
Save Button	Converts traced data into CSV format and saves in a file.	

■ Graph Tab Page

This tab page is used to display a graph of current (vertical axis) and time (horizontal axis) displayed on the History Tab Page.

Note The other setting items and buttons in this tab page are the same as on the History Tab Page.

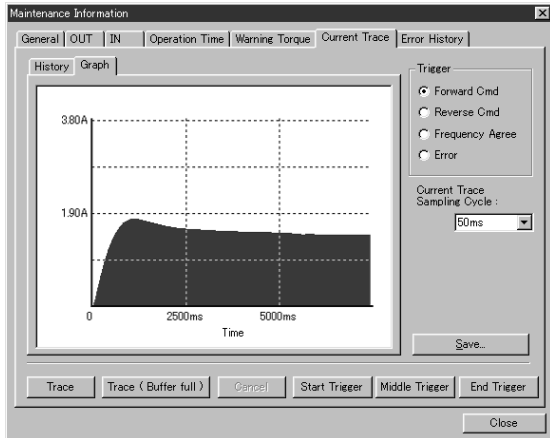

7-5-7 Error History Tab Page

The last four communications errors are displayed as an error log.

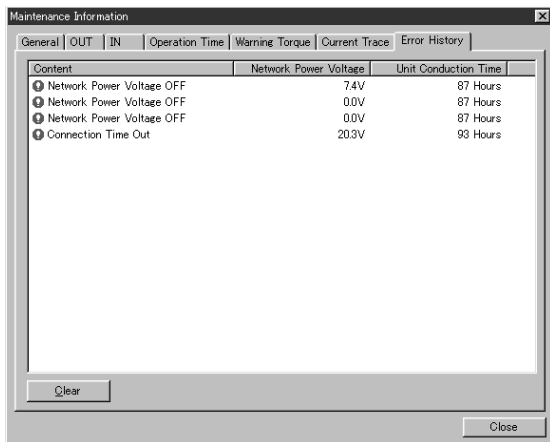

Item		Reference
Content	Displays the details of the errors that have occurred. Note: The most recent error is displayed at the bottom of the list.	7-2-12 Communications Error Log Monitor
Network Power Voltage	Displays the network power supply voltage from when the error occurred.	
Unit Conduction Time	Displays the Unit ON time from when the error occurred.	
Clear Button	Clears the error log.	

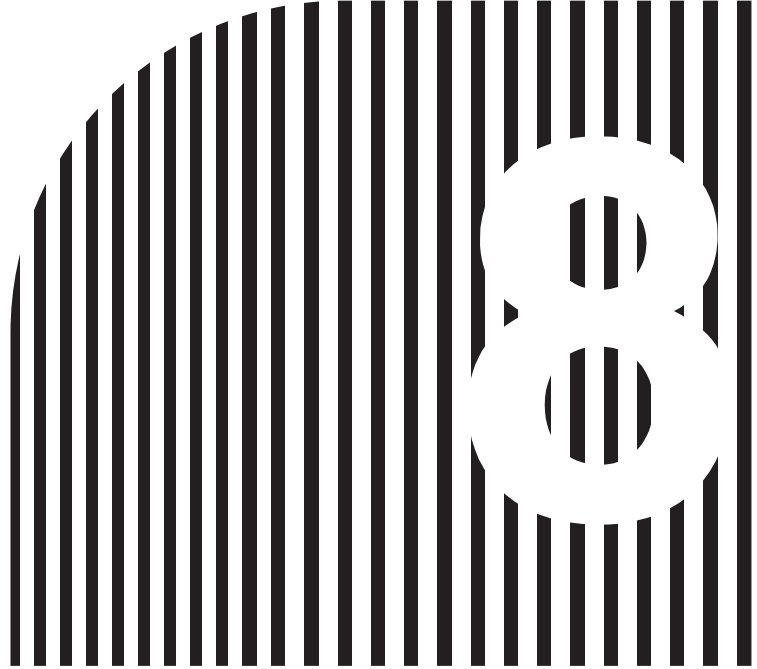

Chapter 8

Communications Errors

- 8-1 Communications Line Errors
- 8-2 Message Communications Errors
- 8-3 Special Remote I/O Errors
- 8-4 Inverter Faults
- 8-5 Inverter Alarms

8-1 Communications Line Errors

Malfunctions in DeviceNet communications that are a result of broken wires, short circuits, reversed wiring, duplicate node address assignments, or noise interference are detected as transmission (BUS) errors. When a transmission error is detected, the Inverter's Fault Bit will turn ON and the motor will coast to a stop.

When an error is detected, perform error processing according to the indicator display of the DeviceNet Communications Unit/Card with the terminal cover and Digital Operator removed.

■ Operation Indicators

The DeviceNet Communications Unit/Card has 2 operation indicators that show the status of the power and communications.

Indicator	Display		Meaning	Countermeasures
	Color	Status		
MS	Green	Lit	The Unit is operating normally.	---
		Flashing	Initial settings or necessary preparations for communications are incomplete.	<ul style="list-style-type: none"> • Turn ON the Inverter power supply again. • Replace the Option Unit.
	Red	Lit	A fatal error (hardware error) has occurred in the Unit.	<ul style="list-style-type: none"> • Turn ON the Inverter power supply again. • Replace the Option Unit.
		Flashing	A non-fatal error, such as a switch setting error, has occurred.	<ul style="list-style-type: none"> • Check the baud rate setting. • Turn ON the Inverter power supply again. • Replace the Option Unit.
	---	Not lit	Power is not being supplied from the Inverter. The Unit is not connected properly and power is not being to supplied to it.	<ul style="list-style-type: none"> • Check the Option Unit connector and turn ON the Inverter power supply. • Replace the Option Unit.

Indicator	Display		Meaning	Countermeasures
	Color	Status		
NS	Green	Lit	The DeviceNet Network is operating normally. (Communications connections established.)	---
		Flashing	The Network is normal, but the communications connection with the Master Unit is not established.	Turn ON the power supply again after the following steps. <ul style="list-style-type: none"> • Register in the scan list. • Set the connection path. • Turn ON the power supply to the Master Unit.
	Red	Lit	A fatal communications error has occurred. A DeviceNet communications error was detected caused by node address duplication or Bus OFF. (These errors make communications impossible.)	Turn ON the power supply again after the following steps. <ul style="list-style-type: none"> • Correct node address duplication. • Connect termination resistance to both ends of the communications line. • Correct communications line connection problem. • Correct the Master Unit errors that occur when the Master Unit stops after communications is once established. • Correct environmental conditions such as noise.
		Flashing	A non-fatal communications error has occurred due to communications timeout.	Turn ON the power supply again after the following processing. <ul style="list-style-type: none"> • Connect termination resistance to both ends of the communications line. • Correct defective connections in the communications line. • Correct environmental conditions such as noise.
		---	Not lit	A DeviceNet Network error has occurred. For example, the Network does not exist, power is not supplied to the Unit, or the baud rates do not match.

Note For communications line problems, detailed error codes will be displayed on the indicators of the Master Unit. Check the error code and take appropriate countermeasures according to the descriptions in *Chapter 9 Troubleshooting and Maintenance of CS/CJ Series DeviceNet Unit Operation Manual (W380)*.

8-2 Message Communications Errors

■ Explicit Message Errors

If an explicit message is sent, but communications do not end normally, one of the following error codes will be returned with service code 94. Check the meaning of the error message, and either correct the message or adjust the timing of the message.

Error Code	Meaning	Countermeasures
0000	Normal end response.	---
08FF	The requested service does not exist.	Correct the service code and send the data again.
09FF	An invalid attribute was detected.	Check and correct the attribute values, and send the data again.
0CFF	The requested service cannot be executed in the current object mode or status.	Stop the Inverter and send the data again.
0EFF	A request has been sent to change an attribute that cannot be changed.	Check and correct the service code and attribute values, and send the data again.
13FF	There is insufficient data to execute the service.	Correct the data size and send the data again.
14FF	The attribute for the service does not exist.	Check and correct the service code and attribute values, and send the data again.
15FF	There is too much data to execute the service.	Correct the data size and send the data again.
16FF	The specified object does not exist.	Check and correct the class and instance values, and send the data again.
20FF	The parameters are invalid or the data is outside the range for the requested service.	Check and correct the data setting range, send the data again.
1FFF	Manufacturer fault code.	Stop the Inverter and send the data again. Check and correct the data setting range, send the data again.

■ FINS Message Errors (CS/CJ Series)

FINS response	Meaning	Likely cause	Countermeasures
0000	Normal completion	---	---
0101	Local node not in network	The local node (DeviceNet Unit) is not participating in the network.	Check the DeviceNet Unit's settings and network settings.
0105	Local node address out-of-range error	The local node's (DeviceNet Unit's) node address is not between 0 and 63.	Set the DeviceNet Unit's node address correctly. (Set a unique node address between 0 and 63.)
0106	Local node address duplication error	The local node's (DeviceNet Unit's) node address is duplicated on another node.	
0201	Remote node not in network	The other node is not participating in the network. (The MS/NS indicators will not be normal.)	Establish a proper network connection at the remote node.

FINS response	Meaning	Likely cause	Countermeasures
0202	No such Unit in remote node	The wrong node address was specified.	Check the other node's node address.
		The DeviceNet Unit's FINS address is incorrect.	Check the FINS address specified in the CMND instruction's control data.
0205	Response timeout	The response monitoring time in the CMND instruction's control data is too short.	Set a longer response monitoring time.
		The message frame was corrupted by noise.	Check for noise (from sources such as the communications power supply and switching devices) and take steps to reduce noise. Consider increasing the number of retries.
0401	Undefined command	The DeviceNet Unit received an unrecognizable command.	Check the CMND instruction's FINS command number (2801).
		The DeviceNet Unit received a FINS command intended for another Unit.	Check the FINS address specified in the CMND instruction's control data.

8-3 Special Remote I/O Errors

■ Special Remote I/O Errors

If each function is not set properly using the special remote I/O, the MSB of the function code will be changed to 1 and one of the following error codes will be returned. Check the meaning of the error message, and either correct the message or adjust the timing of the message.

Error code	Name	Content	Countermeasure
----	---	Normal completion response The function code and register number at the time of transmission are placed at the beginning, and returned with the data amount (when data is written) or the read data (when data is read) attached.	---
01 hex	Function code error	A code other than 03 hex/08 hex/10 hex has been set as a function code.	Check and correct the function code.
02 hex	Register number error	The set register number has not been registered. An attempt to read an enter command register was made.	Check and correct the register number.
21 hex	Data setting error	An upper or lower limit for the write data setting range was exceeded. Data that would give rise to an operation error (OPE1 to OPE9 or OPE01 to OPE09) has been set.	Check the display for the Digital Operator and correct the error data.
22 hex	Writing mode error	during Inverter operations, a write-requested message was received for a parameter that is read-only during operation. An enter command was received during Inverter operations. A read-requested message was received during UV. An enter command was received during UV.	Perform write operations after stopping the Inverter. Perform write operations after clearing the UV (main circuit undervoltage) error.
		3G3MV only: during F04 (initial memory error) detection, a write-requested message other than constant initialization (n001="8" or "9"), was received.	After constant initialization (n001 = "8" or "9") has been performed, turn the power supply OFF and ON again.
		A write-requested message was received for a read-only register.	Check and correct the register number.

■ ENTER Command Not Sent (For 3G3RV, 3G3FV and 3G3PV)

When entering data in the parameter constant (register No. 0100 or higher), always send an ENTER command. If the ENTER command is not transmitted after writing data, the following situation will occur.

- Written data will not be enabled.
Written data will be enabled only after an enter command is sent.

- Inverter will not start.
The Inverter will determine the state as being under programming until it receives an ENTER command and will ignore the start or run command.
After sending an ENTER command, input the start or run command again.

8-4 Inverter Faults

■ Detecting Inverter Faults

When a fault is detected in the Inverter itself, the status will change as shown in the following table.

Function	Meaning
Unit status	When an fault is detected, bit 15 of the Unit Status (Error flag) is turned ON and the fault code is stored in bits 8 to 14. For details on the fault, check the fault code in the fault code table on page 10. When COS communications are used, the remote I/O error flag may be turned ON first.
Remote I/O	The fault output allocated in the remote I/O will turn ON. If the fault output is ON, turn OFF all related inputs controlling the Inverter, and program a sequence to stop the program.
Explicit messages	Read the fault output for Class 29, Instance 1, Attribute 0A using message communications. If there is a fault in the Inverter, the fault output will be ON, so turn OFF all related inputs controlling the Inverter, and program a sequence to stop the program.
Special remote I/O	3G3MV/3G3RV: Read register 002C, and check whether bit 14 (fault output) is ON (serious fault). If bit 14 is ON, turn OFF all related inputs controlling the Inverter, and program a sequence to stop the program. 3G3FV: Read register 0010, and check whether bit 7 (fault output) is ON (serious fault). If bit 7 is ON, turn OFF all related inputs controlling the Inverter, and program a sequence to stop the program.

■ Confirming Inverter Fault Status

The fault information for the Inverter can be checked by using the following methods. Identify the fault using the fault code table on page 8-10 and the troubleshooting information in the Inverter user's manual and take the necessary corrective actions.

Function	Meaning
Operation indicators on Inverter	When there is an Inverter fault, the details will be displayed on the Digital Operator of the Inverter. The fault log can be checked using the monitor function. 3G3MV: U-09 3G3RV/3G3FV: U3
Unit status	The fault code is stored in bits 8 to 14. Bit 15 (Error flag) is turned ON when a fault is detected. When COS communications are used, the remote I/O error flag may be turned ON first.
Explicit messages	An explicit message can be used to read the fault code of a detected fault. Fault codes conforming to DeviceNet: Class 29/Instance 1/ Attribute 0D Fault codes unique to this Unit: Class 2A/Instance 1/Attribute 70
Special remote I/O	3G3MV/3G3RV: Read registers 0021. Check the fault status from the bit signals that are output for an Inverter fault. 3G3FV: Read registers 0014 to 0018. Check the fault status from the bit signals that are output for an Inverter fault. The fault log can be checked using the monitor function (U3) in registers 0090 to 0093.

Note Check the Digital Operator display (see the following table) to identify faults when DeviceNet communications are disabled.

● **Faults when DeviceNet Communications are Disabled**

Inverter		Content	Countermeasure
3G3MV	3G3RV 3G3PV 3G3FV		
F04	CPF04	EEPROM fault There was an inconsistency in the stored data or there is a hardware fault.	<ul style="list-style-type: none"> • Store the parameters again • Turn the power supply OFF and then ON again. • Replace the Inverter if the steps above do not eliminate the fault. <p>Note: This fault may occur if the number of overwrite operations exceeds 100,000. EEPROM is overwritten when a parameter change operation is executed from a Parameter Unit or an ENTER command is sent. Overwrite the data in EEPROM as little as possible.</p>
---	ERR	EEPROM write fault	
F06	CPF06	Option Unit/Card self-test error	<ul style="list-style-type: none"> • Install the DeviceNet Communications Unit/Card correctly. • Align the case with the connector of the DeviceNet Communications Unit/Card so that it is fully installed.
F21	CPF21	Option Unit/Card self-test error	<ul style="list-style-type: none"> • Install the DeviceNet Communications Unit/Card correctly. • Turn the power supply OFF and then ON again. • Replace the DeviceNet Communications Unit/Card if the steps above do not eliminate the fault.
F22	CPF22	Option Unit/Card model code error	<ul style="list-style-type: none"> • Install the DeviceNet Communications Unit/Card correctly. • Turn the power supply OFF and then ON again. • Replace the DeviceNet Communications Unit/Card if the steps above do not eliminate the fault.
F23	CPF23	Option Unit/Card mutual test error A communications error occurred between the DeviceNet Communications Unit/Card and Inverter.	<ul style="list-style-type: none"> • Install the DeviceNet Communications Unit/Card correctly. • Align the case with the connector of the DeviceNet Communications Unit/Card so that it is fully installed. • Check whether the DeviceNet Communications Unit/Card's FG wire is properly connected to the Inverter. • Take steps to reduce noise in the DeviceNet communications lines. (See 3-3 <i>Communications Line Noise Prevention</i> for details.) • Replace the DeviceNet Communications Unit/Card if the steps above do not eliminate the fault.

■ Fault Codes

The DeviceNet Unit/Card has two kinds of fault codes: DeviceNet fault codes and DeviceNet Communications Unit/Card fault codes.

- DeviceNet fault codes: Fault code outputs unified in DeviceNet Class 29/Instance 01/Attribute 0D
- DeviceNet Communications Unit/Card fault codes: Fault codes for Inverter management Class 2A/Instance 01/Attribute 70
Fault code stored in unit status bits 8 to 14 (Error flag in bit 15).

DeviceNet fault code (hex)	Unit/Card fault code	Fault detection supported			Operator display	Content
		3G3MV	3G3RV 3G3PV	3G3FV		
0000	00	Yes	Yes	Yes	---	Inverter normal
5120	01	---	Yes	Yes	PUF	Fuse open
3220	02	Yes	Yes	Yes	UV1	Undervoltage (main)
5110	03	Yes	Yes	Yes	UV2	Control power supply fault
3222	04	---	Yes	Yes	UV3	Undervoltage (3G3RV: MC fault)
2130	05	Yes	---	Yes	SC	Short circuit
2120	06	Yes	Yes	Yes	GF	Ground fault
2300	07	Yes	Yes	Yes	OC	Overcurrent
3210	08	Yes	Yes	Yes	OV	Main circuit overvoltage
4200	09	Yes	Yes	Yes	OH	Overheat (3G3MV/RV: Inverter overheat)
4210	0A	---	Yes	Yes	OH1	Overheat (3G3RV: Inverter overheat)
2220	0B	Yes	Yes	Yes	OL1	Motor overload
2200	0C	Yes	Yes	Yes	OL2	Inverter overload
2221	0D	Yes	Yes	Yes	OL3	Overtorque detection 1
2222	0E	---	Yes	Yes	OL4	Overtorque detection 2
7110	0F	---	Yes	Yes	RR	Braking transistor failure
7112	10	Yes	Yes	Yes	RH	Braking resistor overheating
9000	11	Yes	Yes	Yes	EF3	External fault (Terminal 3)
9000	12	Yes	Yes	Yes	EF4	External fault (Terminal 4)
9000	13	Yes	Yes	Yes	EF5	External fault (Terminal 5)
9000	14	Yes	Yes	Yes	EF6	External fault (Terminal 6)
9000	15	Yes	Yes	Yes	EF7	External fault (Terminal 7)
9000	16	---	---	Yes	EF8	External fault (Terminal 8)
4140	17	---	---	Yes	FAN	Cooling fan fault
7310	18	---	Yes	Yes	OS	Overspeed
7310	19	---	Yes	Yes	DEV	Speed deviation
7301	1A	---	Yes	Yes	PGO	PG is disconnected
3130	1B	Yes	Yes	Yes	PF	Input phase loss (3G3MV/RV input phase loss)
3130	1C	Yes	Yes	Yes	LF	Output phase loss
1000	1D	---	Yes	---	OH3	Motor overheat 1
5300	1E	Yes	Yes	Yes	OPR	Operator disconnection
6320	1F	---	Yes	Yes	ERR	EEPROM write failure
1000	20	---	Yes	---	OH4	Motor overheat 2
7500	21	Yes	Yes	Yes	CE	MEMOBUS transfer error

DeviceNet fault code (hex)	Unit/Card fault code	Fault detection supported			Operator display	Content
		3G3MV	3G3RV 3G3PV	3G3FV		
7500	22	Yes	Yes	Yes	BUS	Communications error
8321	25	---	Yes	Yes	CF	Communications control
8313	26	---	---	Yes	SVE	Zero servo error
9000	27	Yes	Yes	Yes	EFO	External fault
1000	28	Yes	Yes	Yes	FBL	PID feedback reference loss
1000	29	Yes	Yes	---	UL3	Undertorque detection 1
1000	2A	---	Yes	---	UL4	Undertorque detection 2
1000	2B	---	Yes	---	OL7	Overload during HSB
1000	30	Yes	Yes	Yes	CPF□□	Hardware fault (F□□ displayed in 3G3MV)

8-5 Inverter Alarms

■ Detecting Inverter Alarms

The Inverter's alarm codes are not specified in DeviceNet, they are a proprietary function of these products. When an alarm occurs, the status will change as described below.

Function	Inverter alarm status
Remote I/O	The alarm output allocated in the remote I/O will turn ON. If necessary, we recommend programming a sequence to handle the alarm (such as stopping the Inverter) when the alarm output goes ON.
Explicit messages	Read the alarm output for Class 29, Instance 1, Attribute 0B using message communications. We recommend programming a stop sequence (such as turning OFF all related inputs controlling the Inverter) when an alarm occurs in the Inverter.

■ Reading the Alarm Code

The following methods can be used to read the Inverter's alarm code.

Function	Inverter alarm status
Inverter's Operator display	When the Inverter is in alarm status, the relevant information will be displayed (flashing) on the Inverter's Digital Operator.
Explicit messages	The alarm code of an alarm that is currently occurring can be read with message communications. DeviceNet Communications Unit/Card alarm code: Class 2A, Instance 1, Attribute 6F

■ Alarm Codes

The following table lists the alarm codes. Refer to the Maintenance Operation Chapter of your Inverter User's Manual for more details on troubleshooting and correcting alarms (also known as warnings and non-fatal faults).

● 3G3MV Alarm Codes

Alarm code (hex)	Operator display	Meaning
0000	---	No Inverter alarm detected
8000	STP (flashing)	Operator stopped
8001	SER (flashing)	Sequence error
8002	EF (flashing)	External terminal fault
8003	BB (flashing)	Baseblock input
8004	OL3 (flashing)	Overtorque 1
8005	OH (flashing)	Cooling fins overheating
8006	OV (flashing)	Main circuit overvoltage
8007	UV (flashing)	Main circuit undervoltage
8008	FAN (flashing)	Cooling fan fault
8009	CE (flashing)	Communications timeout
800A	BUS (flashing)	Option transfer error
800C	OH3 (flashing)	Motor overheating
800D	FBL (flashing)	Feedback loss error
800E	STP (flashing)	Emergency stop

● 3G3RV/3G3PV/3G3FV Alarm Codes

Alarm code (hex)	Fault detection supported		Operator Display	Content
	3G3RV 3G3PV	3G3FV		
0000	Yes	Yes	---	No Inverter alarm detected.
0001	Yes	Yes	UV (flashing)	Main circuit undervoltage
0002	Yes	Yes	OV (flashing)	Main circuit overvoltage
0003	Yes	Yes	OH (flashing)	Cooling fins overheating
0004	Yes	Yes	OH2 (flashing)	Inverter overheating warning
0005	Yes	Yes	OL3 (flashing)	Overtorque detection 1
0006	Yes	Yes	OL4 (flashing)	Overtorque detection 2
0007	Yes	Yes	EF (flashing)	Simultaneous forward and reverse inputs
0008	Yes	Yes	BB (flashing)	Baseblock input
0009	Yes	Yes	EF3 (flashing)	External fault (Terminal 3)
000A	Yes	Yes	EF4 (flashing)	External fault (Terminal 4)
000B	Yes	Yes	EF5 (flashing)	External fault (Terminal 5)
000C	Yes	Yes	EF6 (flashing)	External fault (Terminal 6)
000D	Yes	Yes	EF7 (flashing)	External fault (Terminal 7)
000E	---	Yes	EF8 (flashing)	External fault (Terminal 8)
0010	Yes	Yes	OS (flashing)	Overspeed
0011	Yes	Yes	DEV (flashing)	Speed deviation
0012	Yes	Yes	PGO (flashing)	PG is disconnected
0013	Yes	Yes	OPR (flashing)	Operator connection fault
0014	Yes	Yes	CE (flashing)	Memobus transfer error
0015	Yes	Yes	BUS (flashing)	Option Card transfer error
0016	Yes	Yes	CALL (flashing)	Communications standby
0017	Yes	Yes	OL1 (flashing)	Motor overload
0018	Yes	Yes	OL2 (flashing)	Inverter overload
0019	---	Yes	E-15 (flashing)	SI-FG transfer error
001A	---	Yes	EFO (flashing)	Option Card external error
001B	Yes	Yes	---	Motor switch during operation
001C	Yes	Yes	FBL (flashing)	PID control feedback reference loss error
001D	Yes	---	CALL (flashing)	Communications standby
001E	Yes	---	UL3 (flashing)	Undertorque detection 1
001F	Yes	---	UL4 (flashing)	Undertorque detection 2
0020	Yes	---	SE (flashing)	Sequence error
0022	Yes	---	OH3 (flashing)	Motor overheating



Chapter 9

Communications Programs (CS-series PLCs)

- 9-1 Standard Remote I/O Programming
- 9-2 Message Communications Programming
- 9-3 Special Remote I/O Programs

Note In this chapter, the bits, words, and data memory used in the example ladder programs were selected arbitrarily. When creating actual programs, modify the contents so that they do not overlap with other areas.

9-1 Standard Remote I/O Programming

When the following standard remote I/O programming is executed, the rotational speed reference data specified in the DM (Data Memory) Area of the PLC is written to the 3G3MV Inverter and forward or reverse operation is performed at the specified frequency when the Frequency Reference Input Bit is turned ON and the Forward Input Bit or Reverse Input Bit is turned ON.

■ Allocations

Bit	000000	← Frequency Reference Input Bit	} Input
Bit	000001	← Forward Input Bit	
Bit	000002	← Reverse Input Bit	
Bit	000003	← Fault Reset Input Bit	
Bit	001000	← Local/Network selection Bit	
Bit	003000	← Fault Flag	
	D00000	← Rotational speed reference data	

● Remote I/O: Outputs from PLC to 3G3MV Inverter Words n and n + 1

Byte		Bit 7	Bit 6	Bit 5	Bit 4	Bit 3	Bit 2	Bit 1	Bit 0	
n	Right-most	0	---	Net Reference	Net Control	---	---	Fault Reset	Reverse/Stop	Forward/stop
	Left-most	1	---	---	---	---	---	---	---	---
n+1	Right-most	2	Rotational speed reference (rightmost data)							
	Left-most	3	Rotational speed reference (leftmost data)							

● Remote I/O: Inputs from 3G3MV Inverter to PLC Words m and m + 1

Byte		Bit 7	Bit 6	Bit 5	Bit 4	Bit 3	Bit 2	Bit 1	Bit 0	
m	Right-most	0	At Frequency	Reference From Net	Control From Net	Inverter Ready	During Reverse Run	During Forward Run	Alarm	Fault
	Left-most	1	---	---	---	---	---	---	---	---
m+1	Right-most	2	Rotational speed monitor (rightmost data)							
	Left-most	3	Rotational speed monitor (leftmost data)							

■ Timing Chart

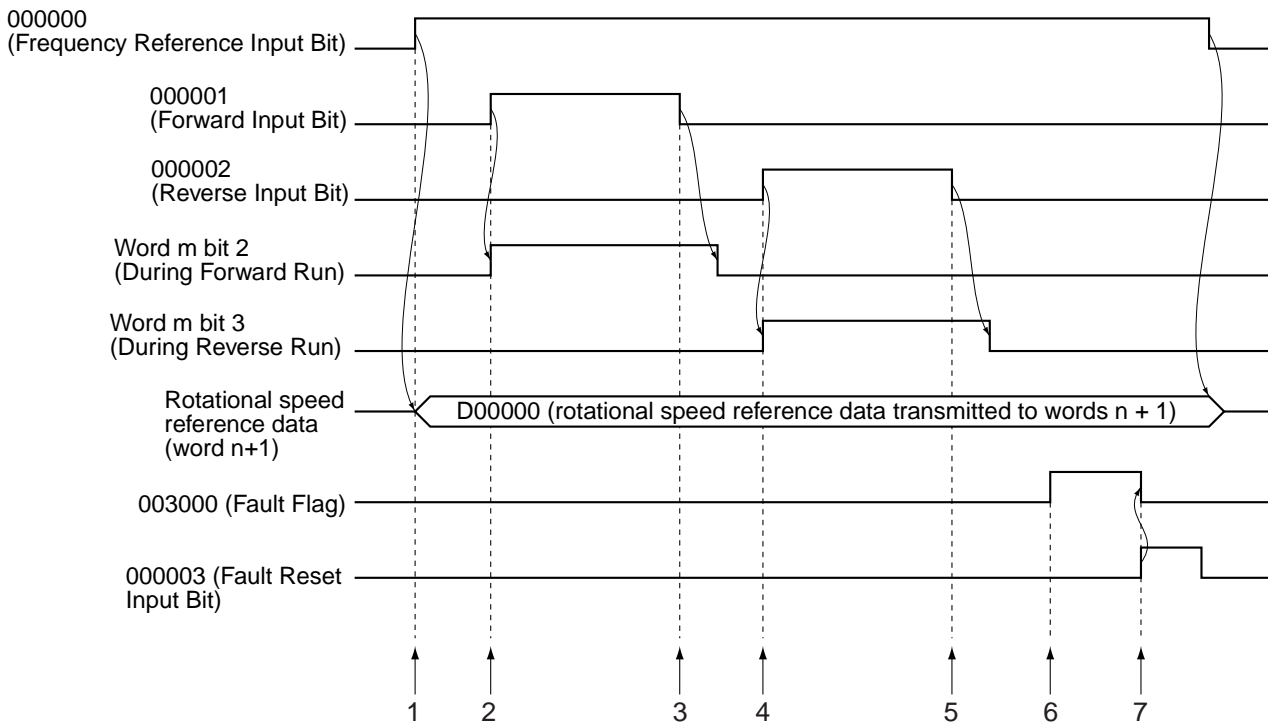

■ Operation

1. When the Frequency Reference Input Bit turns ON, the rotational speed reference data specified in D00000 is moved to remote I/O output word n + 1.
2. When the Forward Input Bit turns ON, remote I/O word n bit 0 (Forward/Stop) will turn ON, and forward operation will start. During forward operation, remote I/O word m bit 2 (During Forward Run) will be ON.
3. When the Forward Input Bit turns OFF, remote I/O word m bit 2 (During Forward Run) will turn OFF after operation will decelerate to a stop.
4. When the Reverse Input Bit turns ON, remote I/O word n bit 1 (Reverse/Stop) will turn ON, and reverse operation will start. During reverse operation, remote I/O word m bit 3 (During Reverse Run) will be ON.
5. When the Reverse Input Bit turns OFF, remote I/O word m bit 3 (During Reverse Run) will turn OFF after operation decelerates to a stop.
6. When the remote I/O Fault Bit (word m bit 0) turns ON, the Fault Flag will turn ON.
7. When the Fault Reset Input Bit turns ON, remote I/O word n bit 2 (Fault Reset Input Bit) will turn ON, and the fault will be cleared. When the fault is reset, the Fault Flag will turn OFF simultaneously.

■ Ladder Program

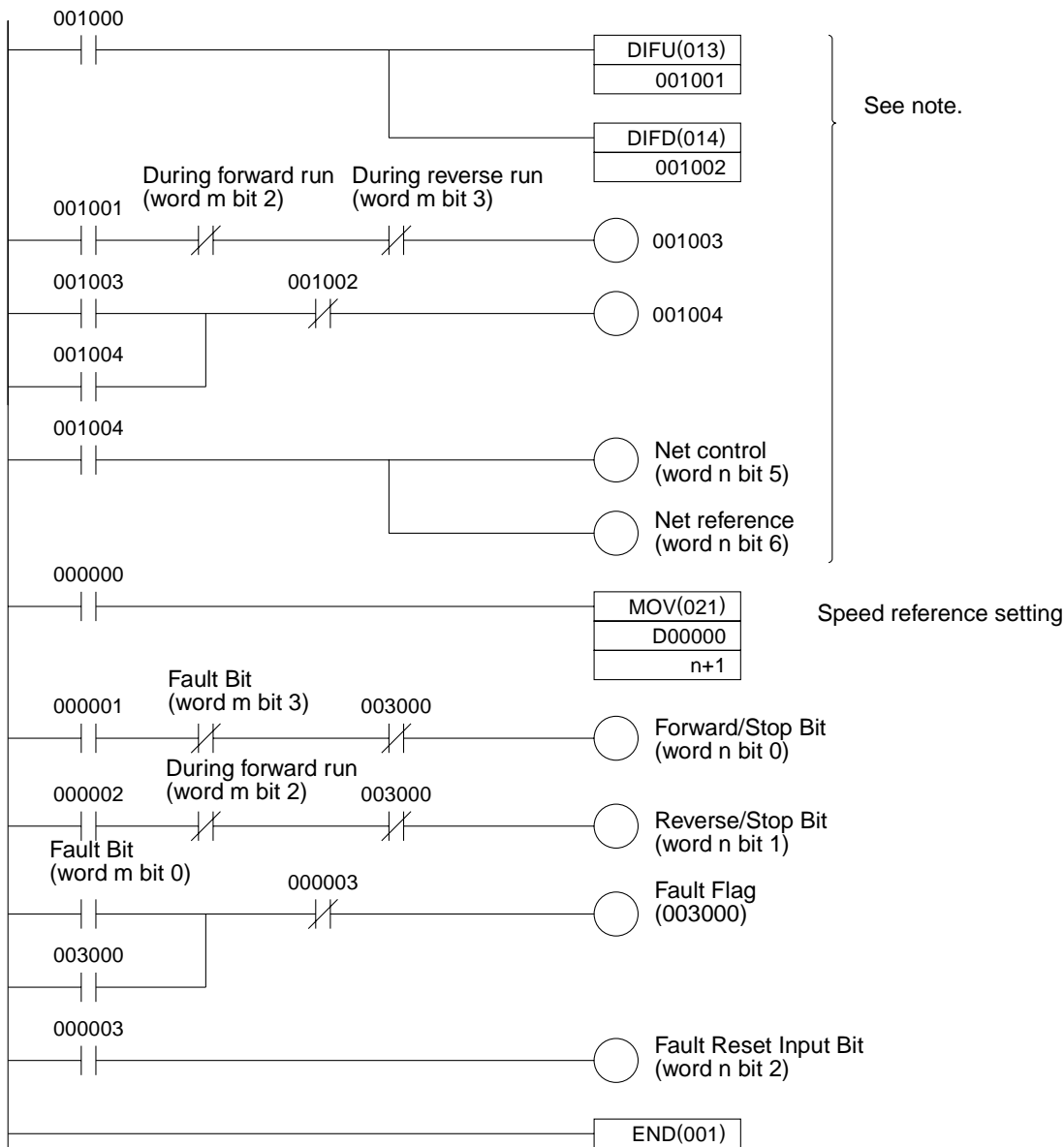

Note This program is used to switch the input method for operation commands and frequency references. It is not required if the n004 (Frequency Reference Selection) is set to "9" and n003 (Inverter Run Command Selection) is set to "3."

9-2 Message Communications Programming

9-2-1 Inverter Fault Processing

The message communications programming example given here reads and stores the fault data using explicit messages for fault outputs from the Inverter. If the Inverter has a fault, the remote I/O input's Fault Bit (word m bit 0) will turn ON. Be sure to turn OFF the Run Command Bits (word n bits 0 and 1). In this program example, the fault code is stored in D00200.

If commands are interrupted by faults, store the completion code in the DM Area and re-execute the command. When a fault occurs, check the contents of the fault and take countermeasures referring to information provided in the *SYSDRIVE 3G3MV Multi-function Compact Inverter User's Manual (I527)*.

■ Allocations

Bit	003000	← Fault Flag	} Flag
Bit	000000	← Fault Code Read Flag	
Bit	000001	← CMND Write Completed Flag	
Bit	000002	← Response Flag	
Bit	003003	← Sending Message Flag	
Bit	003002	← Message Sent Flag	
Bit	000100	← Reset Input Bit	
	D00000	← Slave node address (3G3MV Inverter) (hex)	

Response data storage area

D03000	← Command code: 2801
D03001	← Completion code
D03002	← No. of received data bytes
D03003	← Node address and service code (8E: Read normal; 94: Error)
D03004	← Read data or error code
D00100	← Completion code storage for communications errors
D00200	← Fault code storage for Inverter faults

■ Timing Chart

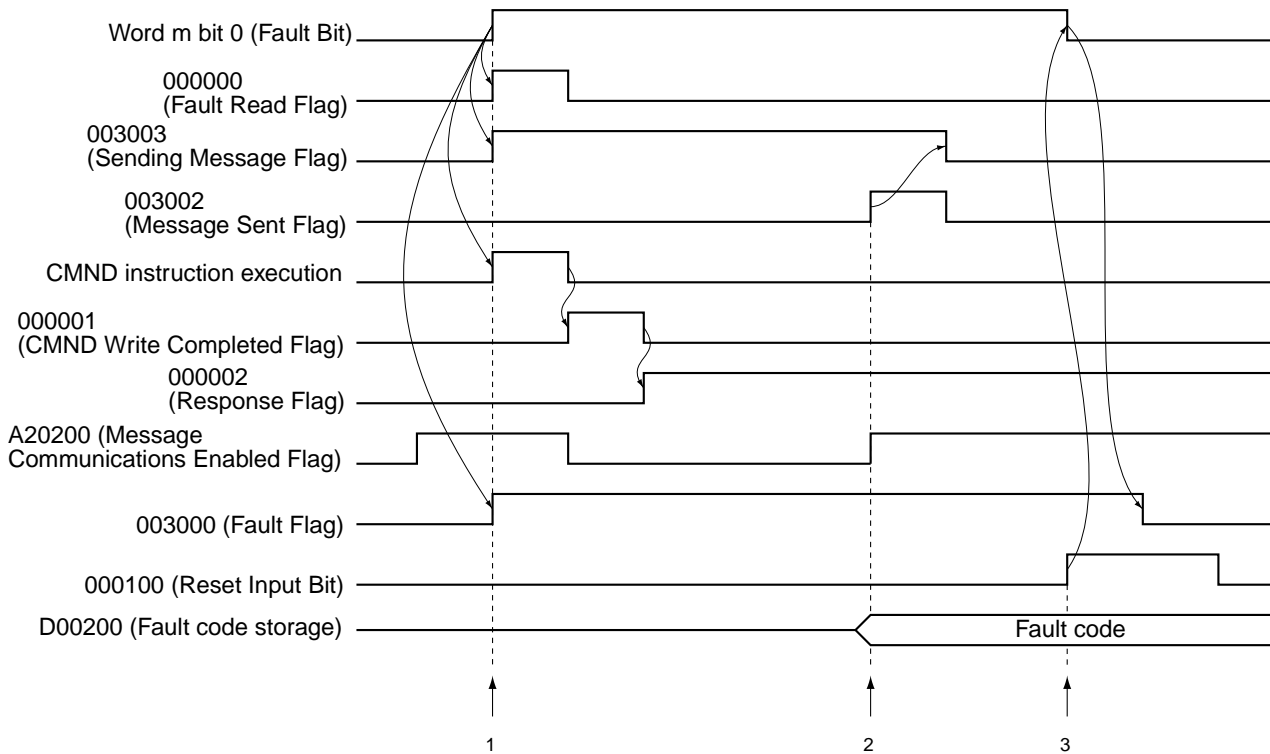

■ Operation

1. When the Inverter has a fault, bit 0 of word m (Fault Bit) will be turned ON. Until the fault is cleared, the Fault Flag will be ON, and this will cause the Fault Read Flag to be turned ON, and the command specified in the DM Area will be sent using the CMND instruction.
2. When the Message Communications Enabled Flag is turned ON, the completion code (D03001) will be examined. If an error is found, the error code will be stored in D00100 and the command will be re-executed. If normally completed, the fault code will be stored in D00200 and the Message Sent Flag will be turned ON, and the Sending Message Flag will be turned OFF.
3. When the Reset Input Bit is turned ON, bit 2 of word n (Fault Reset Input Bit) will turn ON. When the fault is cleared, the Fault Flag will turn OFF.

■ Network Configuration

This program is based on the following conditions.

- Master unit number: 0
- Master node address: 63
- Fixed allocation area setting: 1
- Network Communications Enabled Flag: A20200
- Online Flag: 151100
- Network Communications Error Flag: A21900

■ Ladder Program

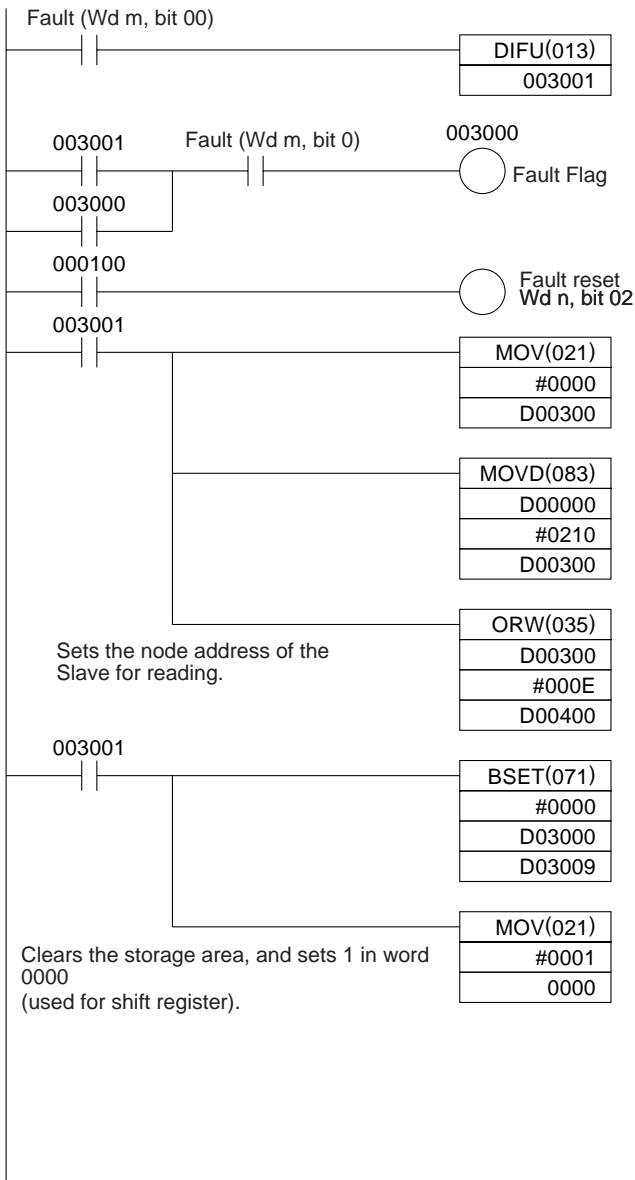

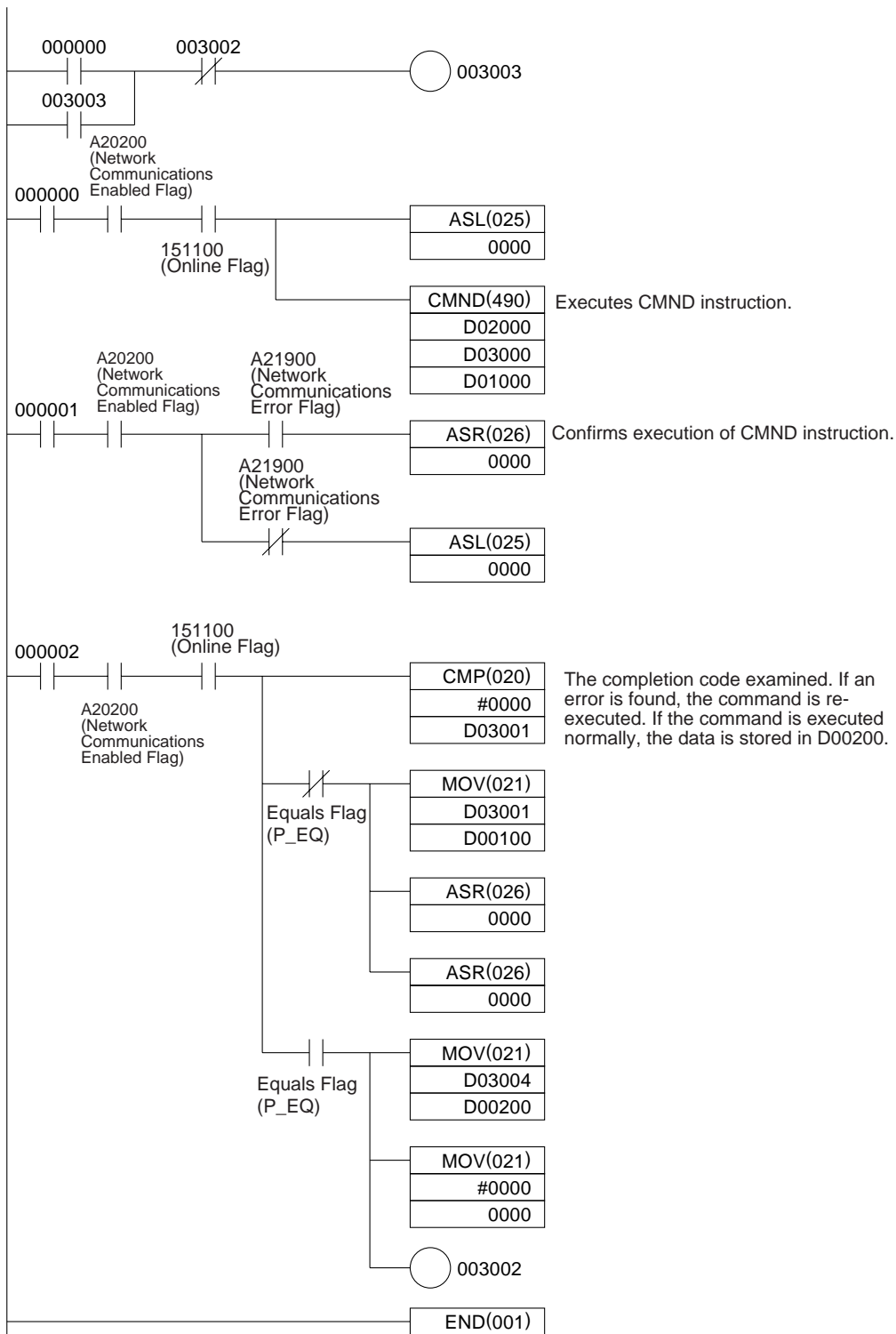

9-2-2 Reading/Writing Data

This programming example writes and reads data using explicit messages. Explicit messages can be executed by specifying FINS commands in the DM Area allocated to the PLC, and sending them using the CMND instruction. (The IOWR instruction is used with C200HX/HG/HE PLCs.)

If there is an error in the command, the completion code is stored in the DM Area and the command is re-executed.

■ Allocations

Bit	001000	← Program Start Input Bit	} Input
Bit	000000	← Message Execution Flag	
Bit	000001	← Command Write Flag	} Flag
Bit	000002	← Response Flag	
Bit	003000	← Sending Message Flag	
Bit	003001	← Message Sent Flag	
	D00000	← Slave node address (3G3MV Inverter)	} Note: If the written data size is Word," set in the order of the rightmost bits and leftmost bits.
	D00001	← Service code; 0E: Read, 10: Write	
	D00002	← Number of command data bytes (Hex)	
	D00003	← Class ID (Hex)	
	D00004	← Instance ID (Hex)	
	D00005	← Attribute ID (Hex)	
	D00006 to D00009	← Write data (Hex) (See note)	

Response data storage area

D03000	← Command code: 2801
D03001	← Completion code
D03002	← No. of received data bytes
D03003	← Node address and service code (8E: Read normal; 90: Write normal; 94: Error)
D03004 to D03007	← Completion code storage for communications errors
D00100	← Read data or error code

■ Timing Chart

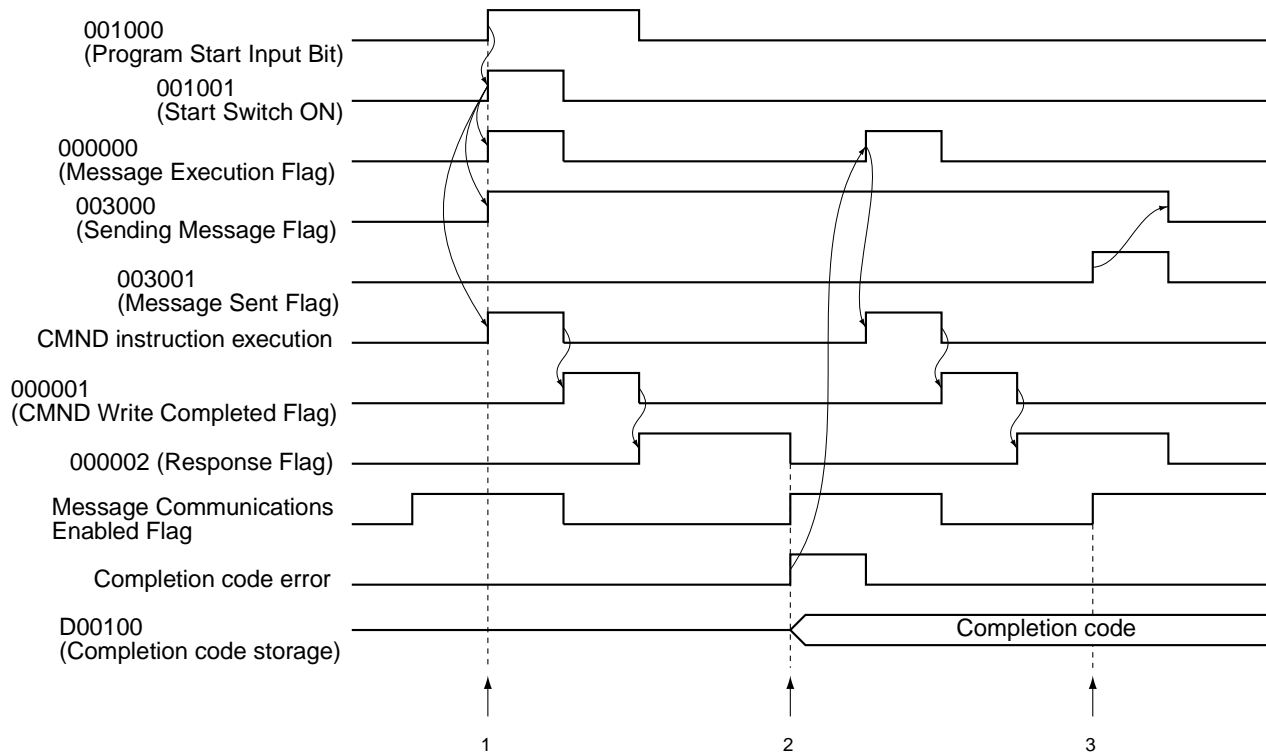

■ Operation

1. When the Program Start Input Bit is turned ON, the Message Execution Flag will turn ON, and the command specified in the DM Area will be sent using the CMND instruction.
2. When the Message Communications Enabled Flag is turned ON, the completion code (D03001) is examined. If an error is found, the completion code is stored in D00100, and the command is re-executed.
3. If the completion code of the response is normal, the Message Sent Flag will be turned ON, and the Sending Message Flag will be turned OFF.

■ Network Configuration

This program is based on the following conditions.

- Master unit number: 0
- Master node address: 63
- Fixed allocation area setting: 1
- Network Communications Enabled Flag: A20200
- Online Flag: 151100
- Network Communications Error Flag: A21900

■ Ladder Program

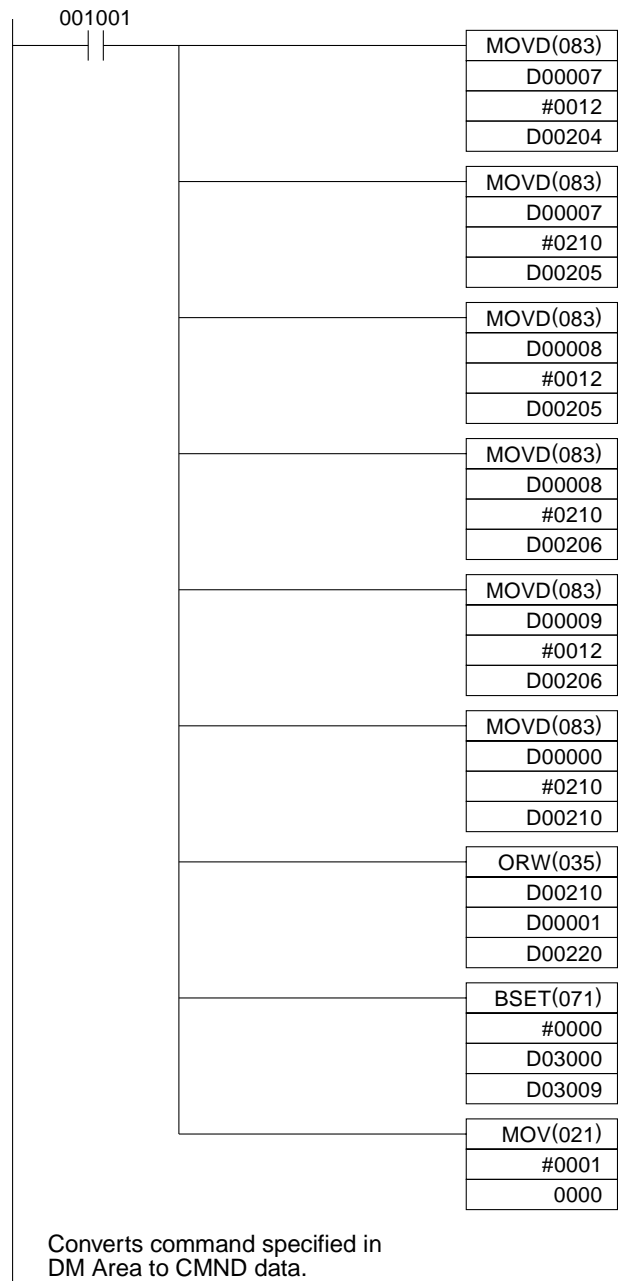
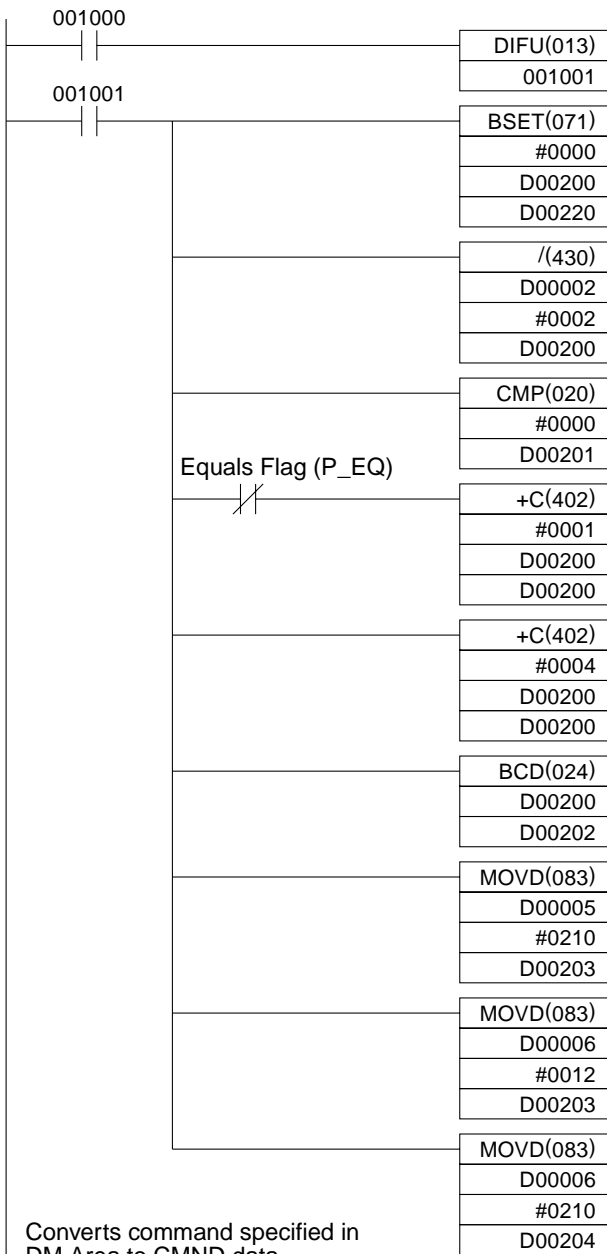

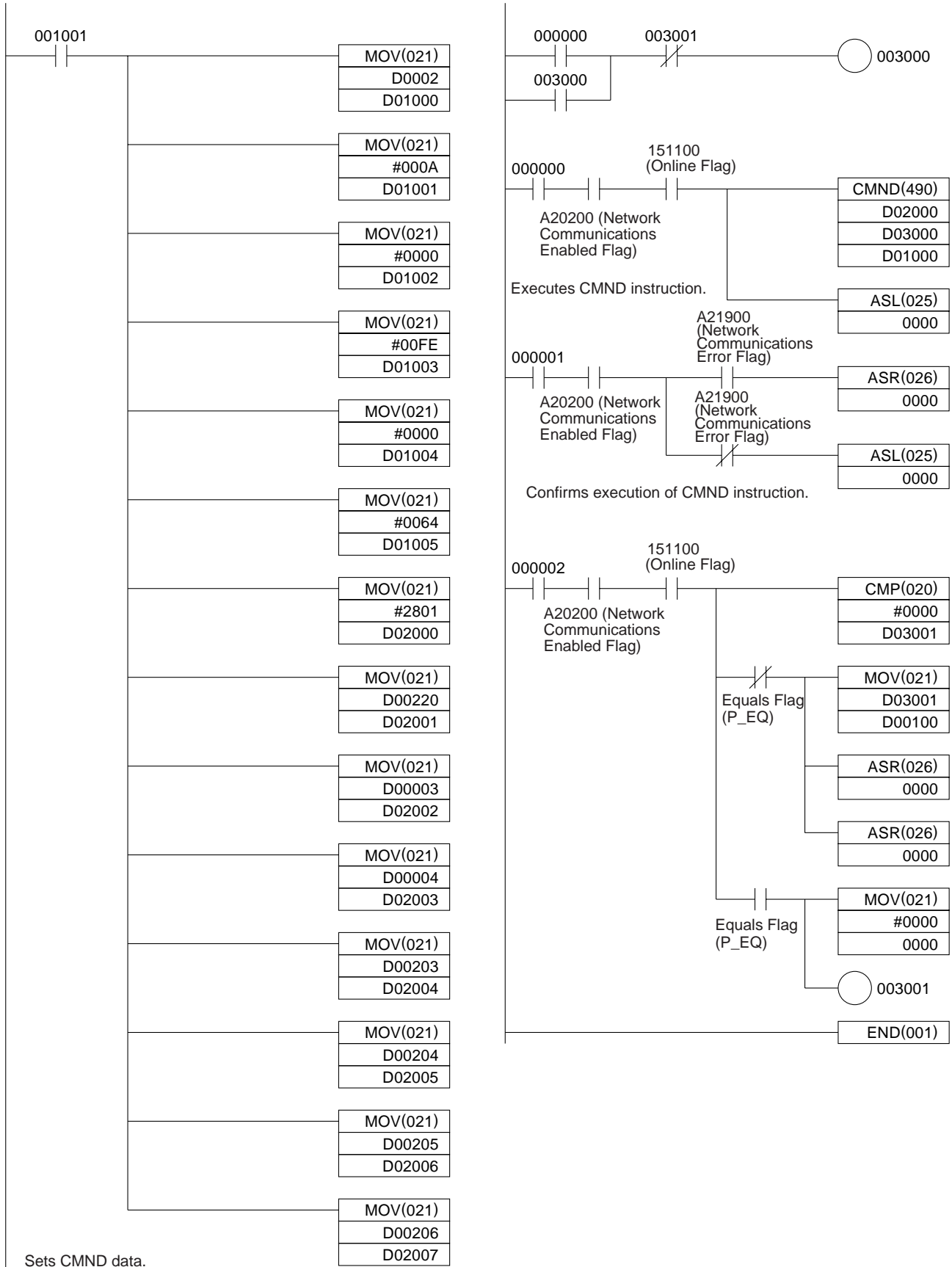

9-3 Special Remote I/O Programs

9-3-1 Simple Operation Programs

This section describes examples of simple operation programming using special remote I/O. To use special remote I/O, it is necessary to switch the remote I/O operation. Refer to 5-2 *Switching the Remote I/O Function* and change to the special remote I/O operation.

Once the Program Start Input Bit is turned ON, Inverter operations will continue until the Program End Input is turned ON. The frequency (speed) reference specified in the DM Area (D01000) of the PLC is repeatedly set in the Inverter. The output frequency value will be repeatedly read and stored in the DM Area (D02000). The Inverter status will also be read repeatedly and stored in words (0020**) allocated in the PLC.

If any communications error occurs, the program will stop and a stop command will be sent to the Inverter. This state will continue until the Communications Fault Reset Input Bit is turned ON.

Note Write the program so that the Inverter operation commands (001000 and 001001) will be turned OFF when the Fault Bit (002014) of the Inverter status turns ON, and also take appropriate countermeasures according to maintenance information in the *SYSDRIVE 3G3MV Multi-function General-purpose Inverter User's Manual*.

■ Allocations

● Inverter Control Input Word Allocation

Word	Function
001000	Forward/Stop (1: forward) Bit
001001	Reverse/Stop (1: reverse) Bit
001002	Multi-function Input 3 (set with n052) Bit
001003	Multi-function Input 4 (set with n053) Bit
001004	Multi-function Input 5 (set with n054) Bit
001005	Multi-function Input 6 (set with n055) Bit
001006	Multi-function Input 7 (set with n056) Bit
001007	Not used.
001008	External Fault Input (1: EFO) Bit
001009	Fault Reset (1: reset) Bit

● Inverter Status Word Allocation

Word	Function
002000	During Run (1: during run) Bit
002001	Zero Speed (1: zero speed) Bit
002002	Frequency Agree (1: frequency agree) Bit
002003	Warning (minor fault) (1: alarm) Bit
002004	Frequency Detect 1 (1: output frequency \leq n095) Bit

Word	Function
002005	Frequency Detect 2 (1: output frequency \geq n095) Bit
002006	Inverter Ready (1: Inverter ready) Bit
002007	UV (1: UV) Bit
002008	Baseblock (1: baseblock) Bit
002009	Frequency Reference Mode (1: not communications) Bit
002010	Run Command Mode (1: not communications) Bit
002011	Overtorque Detection (1: overtorque detected) Bit
002012	Not used.
002013	during Fault Retry (1: during fault retry) Bit
002014	Fault (1: during fault) Bit
002015	Communications Timeover CE (1: communications timeover detected) Bit

● Program-related Bits Used

Word	Function
000000	Program Start Input Bit
000001	Program End Input Bit
000002	Program Execution Flag
000003	Communications Error Reset Input Bit
000004	Inverter Stop Command Flag
000100	Frequency Reference Write Flag
000101	Control Input Write Flag
000102	Output Frequency Read Flag
000103	Inverter Status Read Flag
000300	Frequency Reference Write Completed Flag
000301	Control Input Write Completed Flag
000302	Output Frequency Read Completed Flag
000303	Inverter Status Read Completed Flag
003110	Communications Error Flag

● Inverter Control Input

Word	Function
D01000	Reference frequency setting
D02000	Output frequency monitor

● Remote I/O Allocation Areas

I/O classification	Word address	15 to 8	7 to 0
Output (PLC to 3G3MV Inverter)	n	Register number (leftmost bits)	Function code (10: Write, 03: Read)
	n+1	Register data (leftmost bits)	Register number (rightmost bits)
	n+2	Not used	Register data (rightmost bits)
Input (3G3MV Inverter to PLC)	m	Register number (leftmost bits)	Function code (10: Write, 03: Read)
	m+1	Register data (leftmost bits)	Register number (rightmost bits)
	m+2	Not used	Register data (rightmost bits)

■ Timing Chart

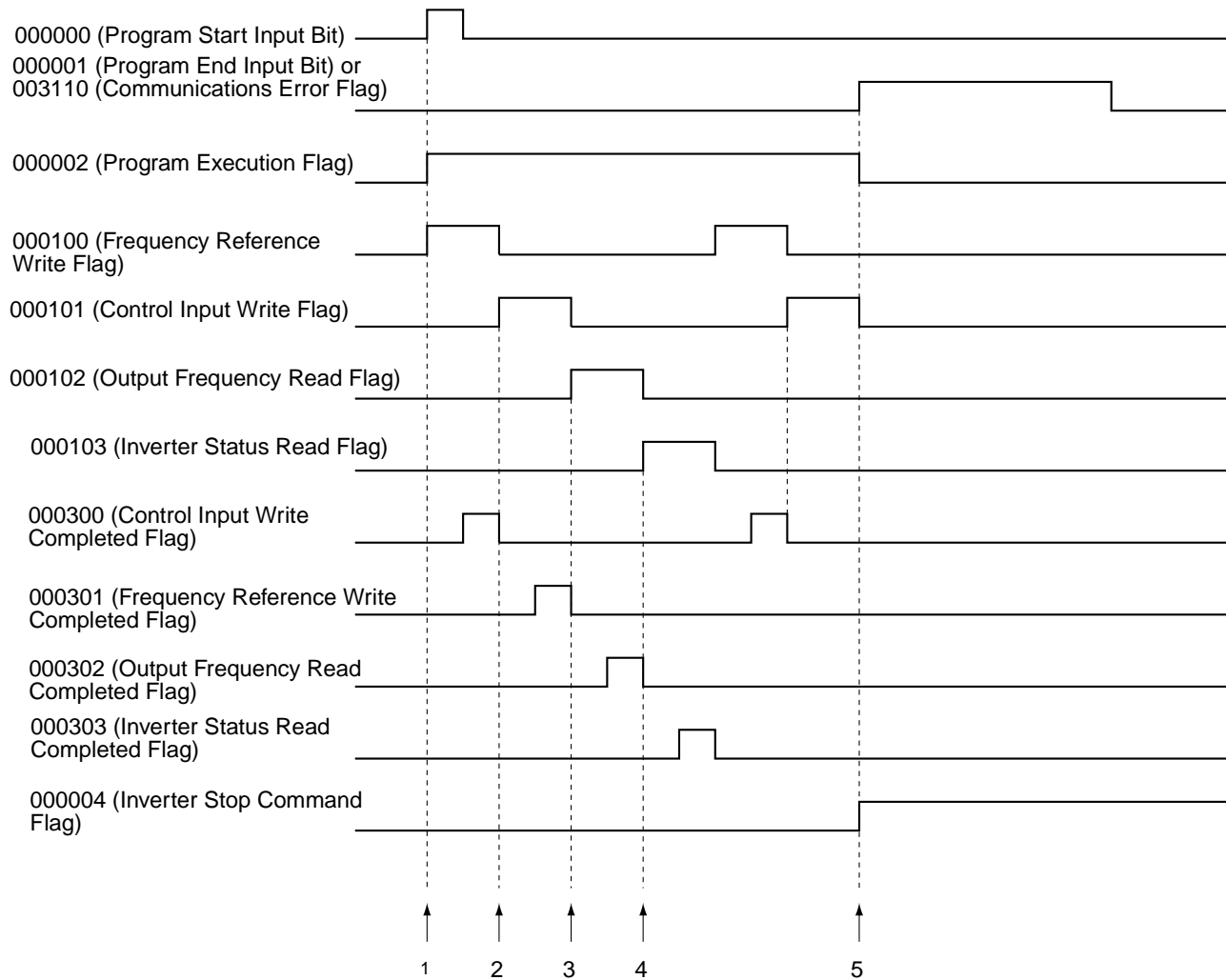

■ Operation

1. When the Program Start Input Bit is turned ON, the Program Execution Input Bit will be set to self-holding and the Frequency Reference Write Flag will be turned ON. When the Frequency Reference Write Flag is ON, the frequency reference data in D01000 will be transferred to the Inverter. When the Frequency Reference Write Completed Flag is turned ON, the Frequency Reference Write Flag will be turned OFF and the Control Input Write Flag will be turned ON. (Bits are shifted to achieve this.)
2. When the Control Input Write Flag is turned ON, the Inverter control input specified in word 0010 will be transferred to the Inverter. When the Control Input Write Completed Flag is turned ON, the Control Input Write Flag will be turned OFF and the Output Frequency Reference Read Flag will be turned ON. (Bits are shifted to achieve this.)
3. When the Output Frequency Read Flag is turned ON, the output frequency of the Inverter will be read. When the Output Frequency Read Completed Flag is turned ON, the read output frequency will be stored in D02000, the Output Frequency Read Flag will be turned OFF, and the Inverter Status Read Flag will be turned ON. (Bits are shifted to achieve this.)
4. When the Inverter Status Read Flag is turned ON, the Inverter status will be read. When the Inverter Status Read Completed Flag is turned ON, the read Inverter status will be transferred to word 0020, the Inverter Status Read Flag will be turned OFF, and the Frequency Reference Write Flag will be turned ON. Setting the Frequency Reference Write Flag to ON will repeat the above steps 1 to 4.
5. When the Program End Input Bit is turned ON, the Inverter stop command will be written in the Inverter. (When word m bit 7 turns ON, communications errors will be detected and the Communications Error Flag will be turned ON and will be self-holding. While this flag remains ON, the system will perform the same processing as when the Program End Input Bit is turned ON. When the Communications Error Reset Input Bit is turned ON, the self-holding state will be cleared.)

■ Ladder Program

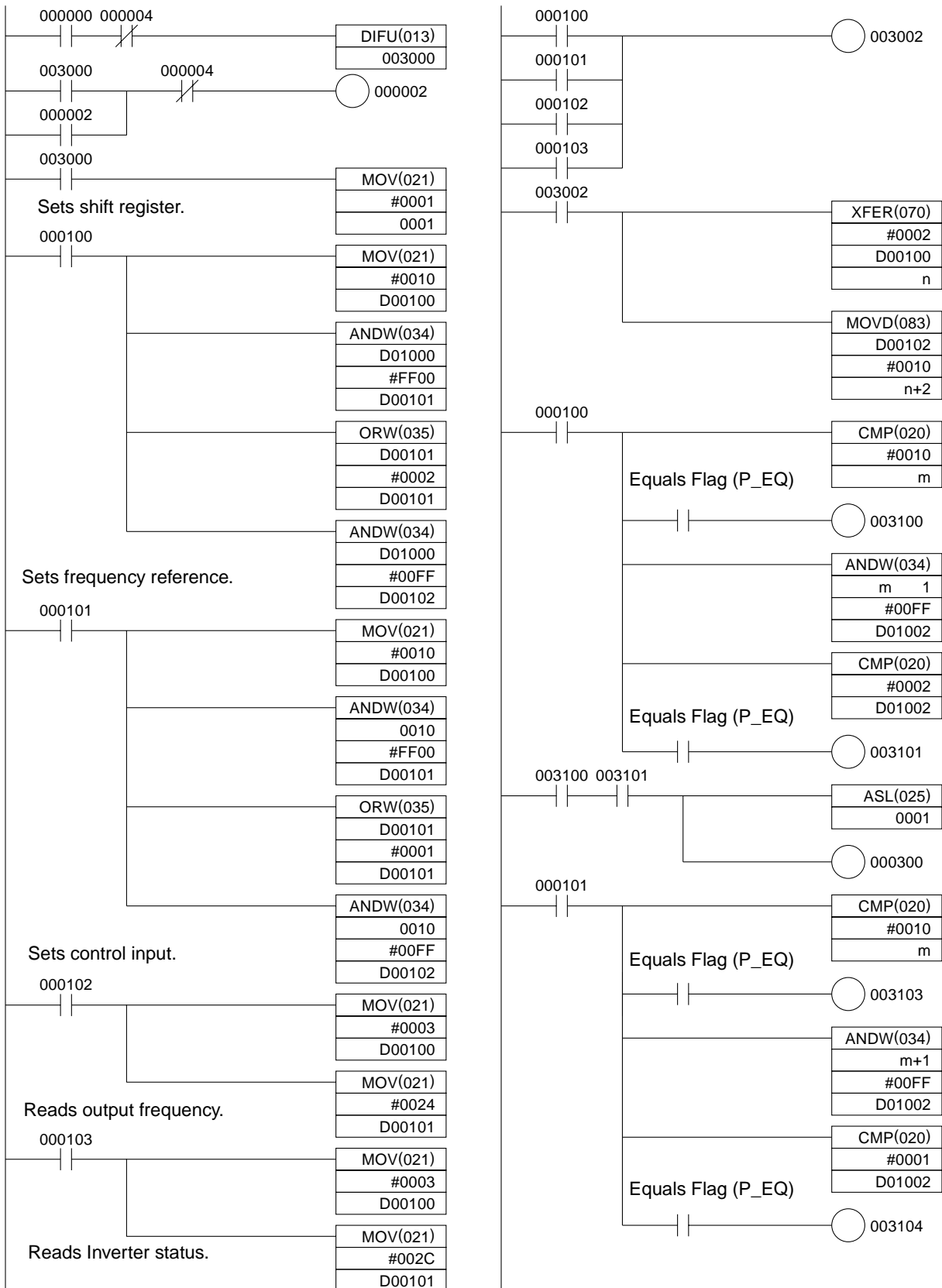

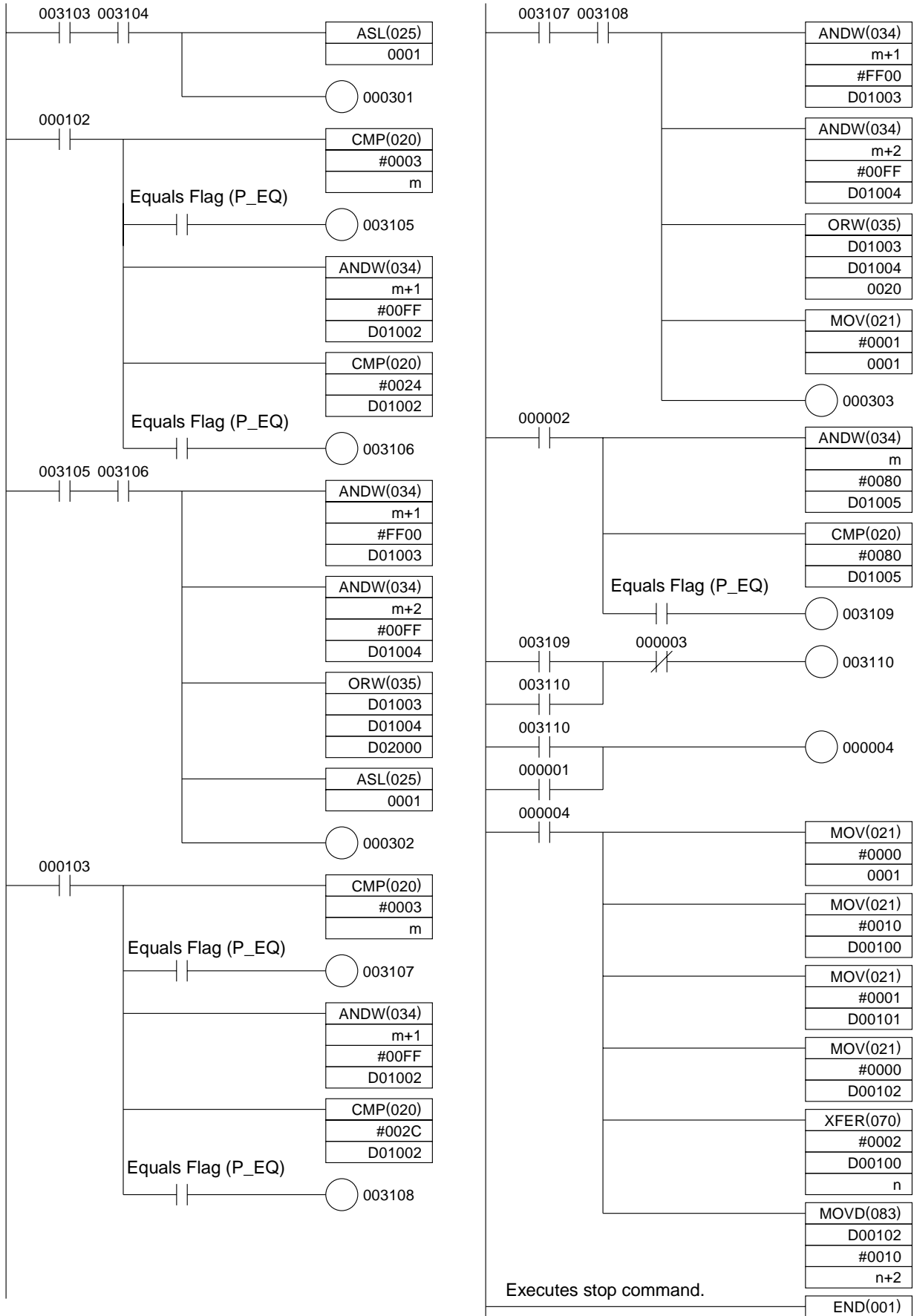

9-3-2 Reading Parameter Data

This programming example is designed to read the parameter data specified in the 3G3MV Inverter. To use special remote I/O, it is necessary to switch the remote I/O operation. Refer to 5-2 *Switching the Remote I/O Function* and change to the special remote I/O operation.

Allocation

Bit	000000	← Read Parameter Input Bit	} Input
Bit	000002	← Faulty Data Reset Input Bit	
Bit	003000	← Data Read Flag	} Flag
Bit	003001	← Faulty Data Flag	
Bit	003005	← Data Read Completed Flag	
	D00000	← Register number of the parameter to be read	
	D00001	← Read data	

Remote I/O Allocation Areas

I/O classification	Word address	15 to 8	7 to 0
Output (PLC to 3G3MV Inverter)	n	Register number (leftmost byte)	Function code (10: Write, 03: Read)
	n+1	Register data (leftmost byte)	Register number (rightmost byte)
	n+2	Not used.	Register data (rightmost byte)
Input (3G3MV Inverter to PLC)	m	Register number (leftmost byte)	Function code (10: Write, 03: Read)
	m+1	Register data (leftmost byte)	Register number (rightmost byte)
	m+2	Not used.	Register data (rightmost byte)

Timing Chart

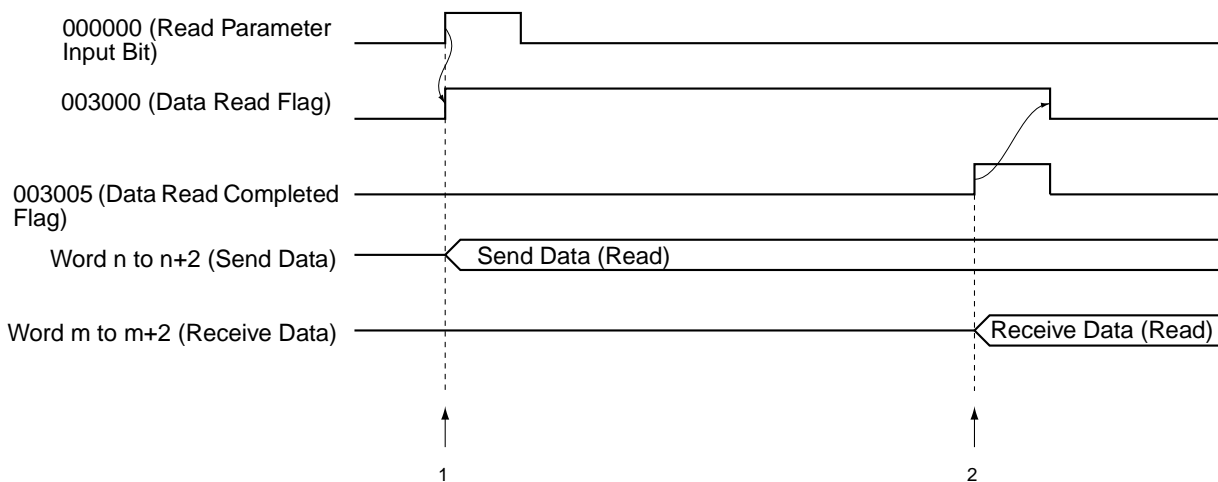

■ Operation

1. Set the register number of the parameter to be read in D00000. When the Read Parameter Input Bit is turned ON, the Data Read Flag will be turned ON and parameter reading processing will be executed.
2. If the data is normally read, the read parameter register number and data will be returned by the Inverter. When the register number that was sent agrees with the received register number, the parameter data will be stored in D00001, the Data Read Completed Flag will be turned ON and the Data Read Flag will be turned OFF.

Note If the send data is faulty, word m bit 7 will be turned ON, which will turn ON the Faulty Data Flag and the program will be stopped until the Faulty Data Reset Input Bit (000002) is turned ON.

■ Ladder Program

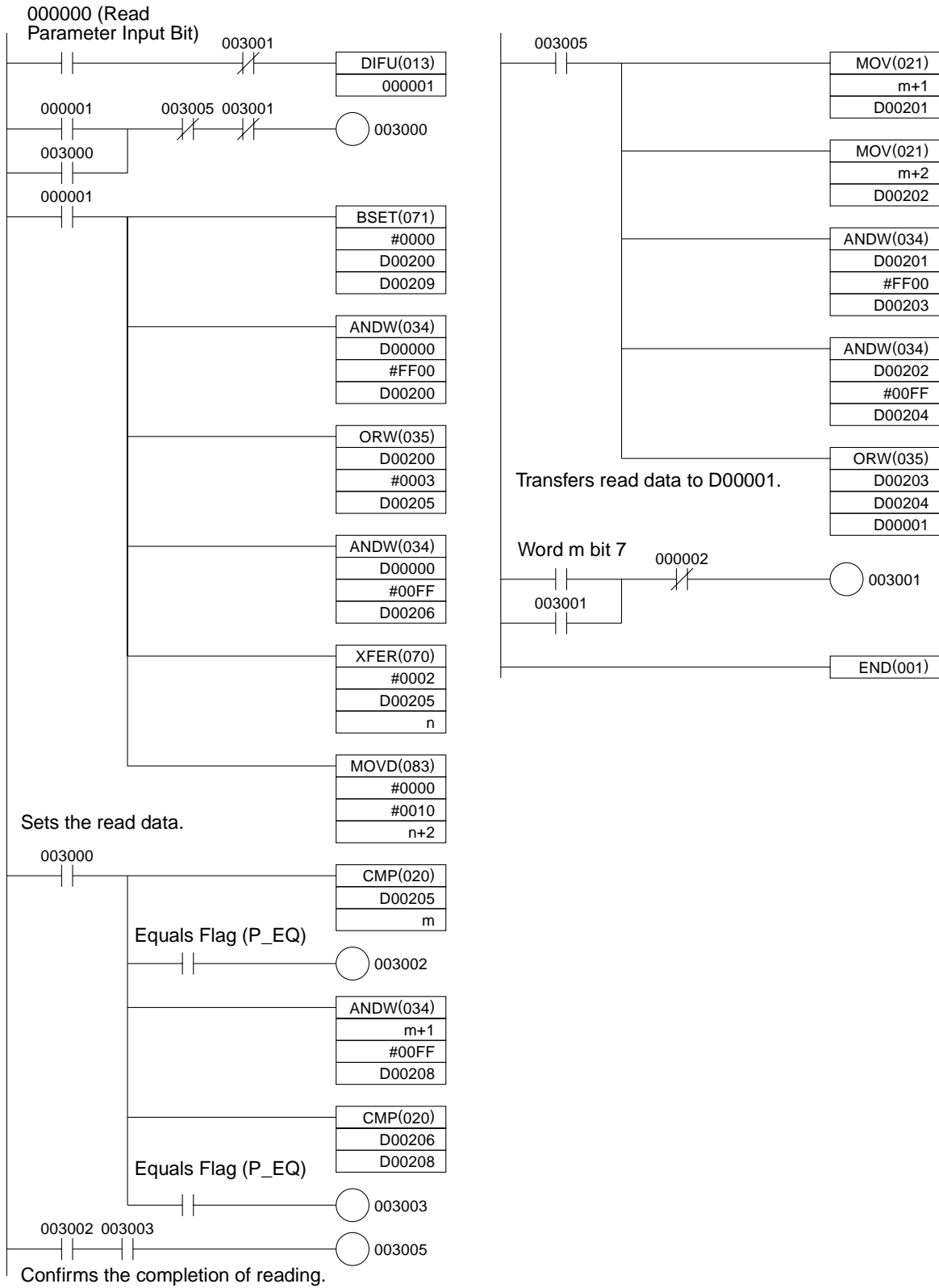

9-3-3 Writing Parameter Data

This programming example is designed to write the parameter data in the 3G3MV Inverter. After writing has been completed, be sure to send an enter command to enable the written data as the Inverter operation data.

To use special remote I/O, it will be necessary to switch the remote I/O operation. Refer to 5-2 *Switching the Remote I/O Function* and change to the special remote I/O operation.

■ Allocations

Bit	000000	← Write Parameter Input Bit	} Input
Bit	000002	← Faulty Data Reset Input Bit	
Bit	003000	← Data Write Flag	
Bit	003005	← Data Agree Flag (Function Code and Register No.)	} Flag
Bit	000100	← Sending Written Data Flag	
Bit	000101	← Sending Enter Command Flag	
Bit	000102	← Setting "00" Function Code Flag	
Bit	000103	← Data Write Completed Flag	
Bit	003010	← Faulty Data Flag	
	D00000	← Register number of the parameter to be written	
	D00001	← Written data	

● Remote I/O Allocation Areas

I/O classification	Word address	15 to 8	7 to 0
Output (PLC to 3G3MV Inverter)	n	Register number (leftmost byte)	Function code (10: Write, 03: Read)
	n+1	Register data (leftmost byte)	Register number (rightmost byte)
	n+2	Not used	Register data (rightmost byte)
Input (3G3MV Inverter to PLC)	m	Register number (leftmost byte)	Function code (10: Write, 03: Read)
	m+1	Register data (leftmost byte)	Register number (rightmost byte)
	m+2	Not used	Register data (rightmost byte)

■ Timing Chart

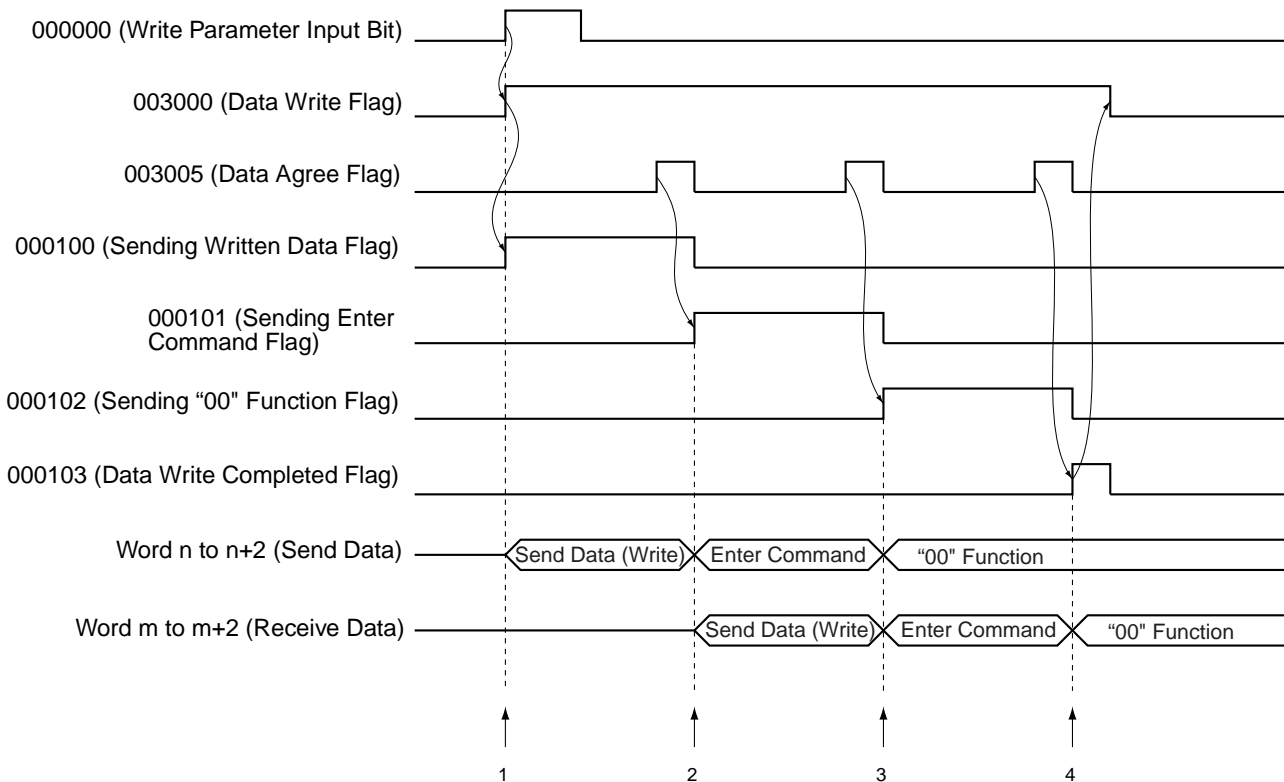

■ Operation

1. Set the register number of the parameter and the data to be written in D00000 and D00001 respectively. When the Write Parameter Input Bit is turned ON, the Data Write Flag will be turned ON and parameter writing processing will be executed.
2. If the data is properly written, the written parameter register number and the function code will be returned from the Inverter. When the sent register number and the function code agree with the received data contents, the Data Agree Flag will be turned ON to send the enter command.
3. If the enter command is normally received, the register number and function code that agree with the enter command will be returned from the Inverter. When the sent register number and function code agree with the received contents, the Data Agree Flag will be turned ON to send the function code "00" (both the register number and function code are 0000).
4. In the same manner, if the function code "00" is normally received, the Data Agree Flag will be turned ON and the Data Write Completed Flag will be turned ON. When the Data Write Completed Flag turns ON, the Data Write Flag will turn OFF and the program will stop.

Note 1. If the enter command remains set, data will be repeatedly written to EEPROM. Therefore, set the function code to "00" (both the register number and function code are 0000), which performs no processing, to disable the enter command.

Note 2. If the sent data is faulty, word m bit 7 will be turned ON, which will turn ON the Faulty Data Flag and the program will be stopped until the Faulty Data Reset Input Bit (000002) is turned ON.

■ Ladder Program

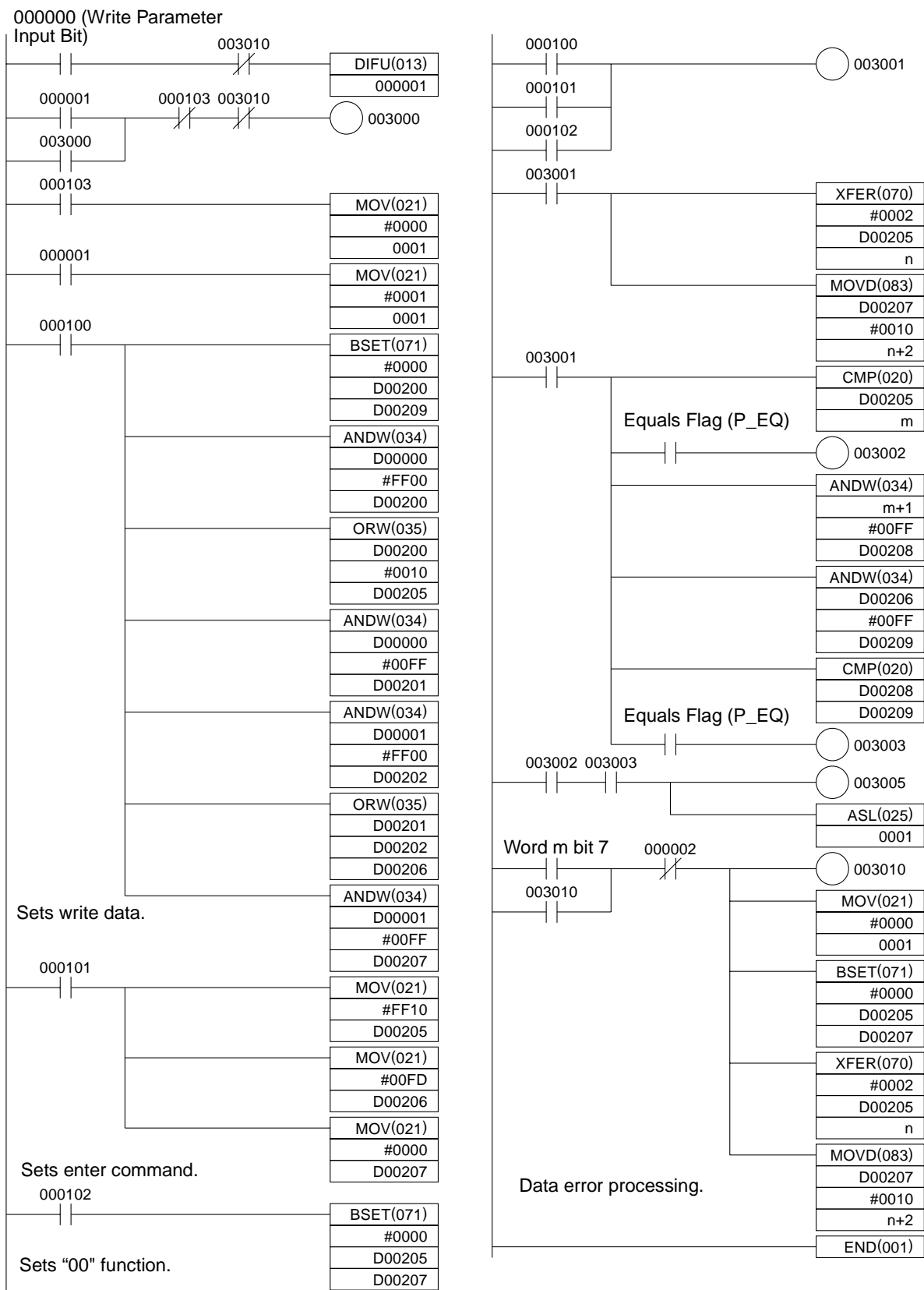

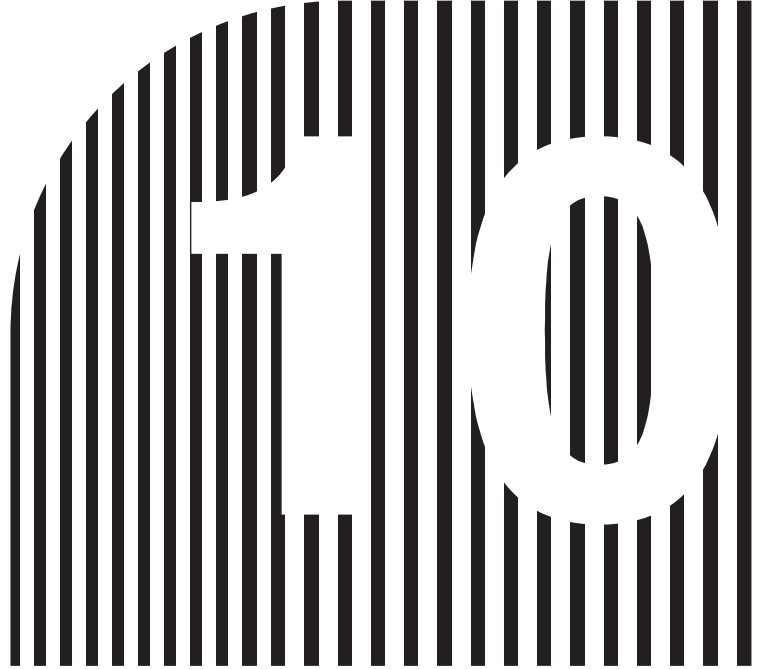

Chapter 10

Appendices

- 10-1 Specifications
- 10-2 Objects
- 10-3 DeviceNet Communications Response Time
- 10-4 3G3MV Register Numbers, Classes, Instances, and Attributes
- 10-5 3G3RV Register Numbers, Classes, Instances, and Attributes
- 10-6 3G3PV Register Numbers, Classes, Instances, and Attributes
- 10-7 3G3FV Register Numbers, Classes, Instances, and Attributes

10-1 Specifications

10-1-1 DeviceNet Communications Unit Specifications

Item	Specifications
Model	3G3MV-PDRT2
Remote I/O	<ul style="list-style-type: none"> • Basic remote I/O: Allocated 2 input words and 2 output words • Standard remote I/O (default setting): Allocated 2 input words and 2 output words • Special remote I/O: Allocated 3 input words and 3 output words • Control remote I/O: Allocated 4 or 5 input words and 4 output words • Unit status: Allocated 1 input word • Multi-function input monitor: Allocated 1 input word <p>Note 1. The user can select from among these six types of remote I/O.</p> <p>Note 2. Basic and standard remote I/O are compatible with DeviceNet. The other remote I/O functions are applicable only to this product and are not defined in DeviceNet Specification.</p>
Explicit messages	<p>A maximum of 32 bytes of data can be sent or received.</p> <p>Note Explicit messages are applicable to the AC/DC drive profile.</p>
Baud rate	125, 250, or 500 kbps, automatically matches the baud rate of the Master Unit.
Communications power supply specifications	11 to 25 V DC (50 mA max., 20 mA typical)
Internal circuit power supply	Supplied from the 3G3MV Inverter.
Operating location	Indoors (with no corrosive gases, oil mist, metallic particles, etc.)
Operating ambient temperature	-10 to 50°C
Operating ambient humidity	90% RH max. (with no condensation)
Storage temperature	-20 to 60°C
Area	1,000 m max.
Weight	100 g max.

■ Dimensions

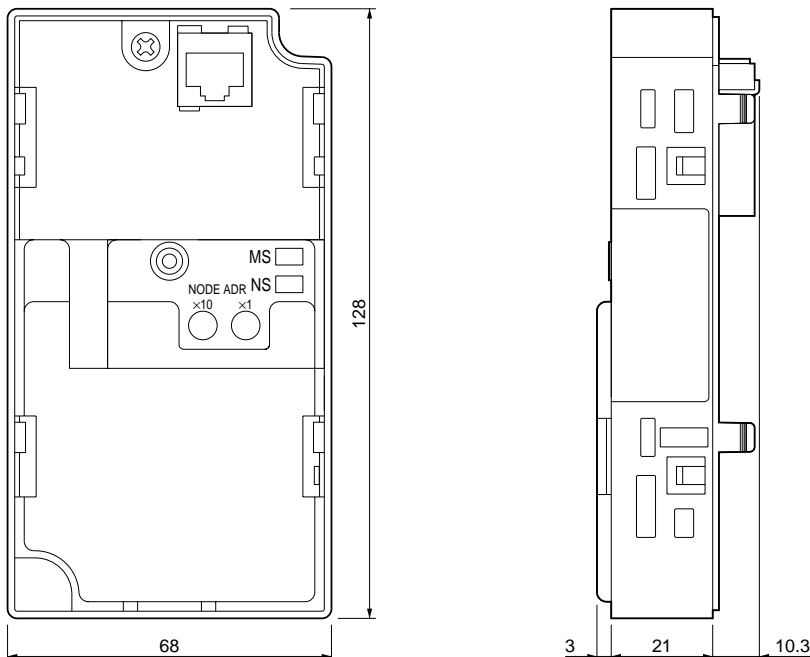

10-1-2 DeviceNet Communications Card Specifications

Item	Specifications
Model	3G3RV-PDRT2
Remote I/O	<ul style="list-style-type: none"> • Basic remote I/O: Allocated 2 input words and 2 output words • Standard remote I/O (default setting): Allocated 2 input words and 2 output words • Special remote I/O: Allocated 3 input words and 3 output words • Control remote I/O: Allocated 4 or 5 input words and 4 output words • Unit status: Allocated 1 input word • Multi-function input monitor: Allocated 1 input word <p>Note 1. The user can select from among these six types of remote I/O.</p> <p>Note 2. Basic and standard remote I/O are compatible with DeviceNet. The other remote I/O functions are applicable only to this product and are not defined in DeviceNet Specification.</p>
Explicit messages	<p>A maximum of 32 bytes of data can be sent or received.</p> <p>Note Explicit messages are applicable to the AC/DC drive profile.</p>
Baud rate	125, 250, or 500 kbps, automatically matches the baud rate of the Master Unit.
Communications power supply specifications	11 to 25 V DC (50 mA max., 20 mA typical)
Internal circuit power supply	Supplied from the 3G3RV/3G3FV Inverter.
Operating location	Indoors (with no corrosive gases, oil mist, metallic particles, etc.)
Operating ambient temperature	-10 to 45°C
Operating ambient humidity	90% RH max. (with no condensation)
Storage temperature	-20 to 60°C
Area	1,000 m max.
Weight	50 g max.

10-2 Objects

10-2-1 Identity Objects (Identification Information): Class 01 Hex

Identity objects are objects that provide DeviceNet product information. All of this information is read-only.

■ Support Service Code

Service code number (hex)	Service
0E	Get attribute single
05	Reset (return to initial status)

■ Object Details

Instance	Attribute	Name	Content	Setting range	Default	Read	Write	Size
01	01	Vender ID	Indicates the maker's code. OMRON: 47 (2F hex)	---	002F	Yes	No	Word
	02	Device Type	Indicates the DeviceNet profile classification. The Inverter corresponds to the AC/DC Drive. • Master Unit: 0 • AC/DC Drive: 2	---	0002	Yes	No	Word
	03	Product Code	Assigned to each series by each maker.	---	See note.	Yes	No	Word
	04	Revision	Indicates overall software revisions for the DeviceNet Communications Card.	---	02.01	Yes	No	Byte × 2
	05	Status	Indicates the communications status of the DeviceNet Communications Card.	---	0000	Yes	No	Word
	06	Serial Number	Indicates the product serial number of the DeviceNet Communications Card. (60000000 hex onwards)	---	Depends on product.	Yes	No	Long
	07	Product Name	Indicates product model number.	---	See note.	Yes	No	String
	08	State	Not supported.	---	---	---	---	---

Note The following table shows the contents of the Product Name and Product Code.

Communications Unit/Card	Model number	Product Name	Product Code
3G3MV-PDRT2	3G3MV-□	3G3MV-PDRT2	61 (3D hex)
3G3RV-PDRT2	3G3PV-□	3G3PV-PDRT2	63 (3F hex)
	3G3RV-□	3G3RV-PDRT2	64 (40 hex)
	3G3FV-□	3G3FV-PDRT2	62 (3E hex)

Restarting Communications

The Communications Unit can be restarted using the following explicit message conforming to DeviceNet communications.

Service 05 hex/Class 01 hex/Instance 01 hex/Attribute none/Data 00

- Use this message to enable parameter settings that are reflected at restart such as the default connection path and average power calculation cycle.
- The Inverter will not restart from this command. To restart the Inverter, turn OFF the power and then turn ON again.

10-2-2 Message Router Objects: Class 02 Hex

Message router objects have the function of distributing DeviceNet communications data. Message router objects themselves are involved in internal processing only and do not have data to be exchanged externally.

■ Support Service Code

Service code number (hex)	Service
0E	Get attribute single

■ Object Details

Instance	Attribute	Name	Content	Setting range	Default	Read	Write	Size
---	---	Not supported.	---	---	---	---	---	---

10-2-3 DeviceNet Objects: Class 03 Hex

DeviceNet objects are related to DeviceNet communications information and operations. Processing is performed automatically after the communications connection is established, so the functions and data have no particular use for the user.

■ Support Service Code

Service code number (hex)	Service
0E	Get attribute single
10	Set attribute single
4B	Allocate Master/Slave Connection Set
4C	Release Master/Slave Connection Set

■ Object Details

Instance	Attribute	Name	Content	Setting range	Default	Read	Write	Size
00	01	Object Software Revision	Indicates class 03 software revisions. The revision value is advanced whenever there is a change.	---	0001	Yes	No	Word
01	01	MAC ID	Switch setting: 00 to 63 The communications node address is specified by the switches and cannot be overwritten.	---	00	Yes	No	Byte
			Switch setting: 64 to 99 The communications node address is specified by the software settings. The default setting is 00.	00 to 63	00	Yes	Yes	Byte
	02	Baud Rate	Indicates the baud rate. 00: 125 Kbps 01: 250 Kbps 02: 500 Kbps	---	00	Yes	No	Byte
	03	BOI	---	---	0000	Yes	No	Word
	04	Bus-off Counter	---	---	0000	Yes	No	Word
	05	Allocation Information	Indicates DeviceNet communications connection information. Note: Cannot be written for explicit messages. (Error is returned.)	---	00 00	Yes	Yes	Byte × 2

10-2-4 Assembly Objects: Class 04 Hex

Assembly objects are objects related to remote I/O operations. Remote I/O operations are configured with these objects for communications.

■ Support Service Code

Service code number (hex)	Service
0E	Get attribute single
10	Set attribute single

■ Object Details

Instance	Attribute	Name	Content	Setting range	Default	Read	Write	Size
14	03	Remote I/O data	Operation is the same as for basic remote I/O (output).	See note 1.	00 00 00 00	Yes	Yes	Byte × 4
15	03	Remote I/O data	Operation is the same as for standard remote I/O (output).	See note 1.	00 00 00 00	Yes	Yes	Byte × 4
46	03	Remote I/O data	Operation is the same as for basic remote I/O (input).	---	00 00 00 00	Yes	No	Byte × 4
47	03	Remote I/O data	Operation is the same as for standard remote I/O (input).	---	00 00 00 00	Yes	No	Byte × 4
64	03	Remote I/O data	Operation is the same as for special remote I/O (output).	See note 1.	00 00 00 00 00	Yes	Yes	Byte × 5
65	03	Remote I/O data	Remote I/O data	See note 1.	00 00 00 00 00 00 00 00	Yes	Yes	Byte × 8
96	03	Remote I/O data	Operation is the same as for special remote I/O (input).	---	00 00 00 00 00	Yes	No	Byte × 5
97	03	Remote I/O data	Operation is the same as for control remote I/O (input).	---	00 00 00 00 00 00 00 00	Yes	No	Byte × 8
98	03	Remote I/O data	Operation is the same as for control remote I/O + unit status (input).	---	00 00 00 00 00 00 00 00 00	Yes	No	Byte × 10
99	03	Remote I/O data	Operation is the same as for control remote I/O + multi-function input monitor (input).	---	00 00 00 00 00 00 00 00 00	Yes	No	Byte × 9
9A	03	Remote I/O data	Operation is the same as for unit status (input).	---	00 00	Yes	No	Byte × 2
9B	03	Remote I/O data	Operation is the same as for multi-function input monitor (input).	---	00	Yes	No	Byte × 1

- Note 1.** The setting ranges are the same as the respective remote I/O setting ranges.
- Note 2.** The remote I/O functions are the same as the functions explained in *Chapter 5 Remote I/O Functions*.
- Note 3.** Remote I/O can be performed by means of message communications. When a normal remote I/O communications connection is established, however, the message communications cannot be used for that purpose. Even if an attempt is made to use message communications, they will be overwritten by remote I/O inputs.

10-2-5 DeviceNet Connection Objects: Class 05 Hex

DeviceNet connection objects are objects related to information and operations involving DeviceNet communications connections. The Master Unit uses the information and operations of these objects to execute the initial processing for communications.

The functions and data have no particular use for the user.
 Use this object when switching the remote I/O function.

■ Support Service Code

Service code number (hex)	Service
05	Reset (reset to initial status)
0E	Get attribute single
10	Set attribute single

■ Object Details

Instance	Attribute	Name	Content	Setting range	Default	Read	Write	Size
00	01	Object Software Revision	Indicates class 05 software revisions. The revision value is advanced whenever there is a change.	---	0001	Yes	No	Word
01 Explicit message	01	State	Indicates the status of this object (instance). 00: Does not exist in network, or is not ready. 01: In network state, waiting for connection event from Master Unit. 02: Waiting for connection ID (attribute) writing. 03: Connection completed. 04: Timeout	---	Must be "03" when communications are established.	Yes	No	Byte
	02	Instance type	Indicates the type of object (instance). 00: Explicit message 01: Remote I/O	---	00	Yes	No	Byte
	03	Transport class trigger	Indicates the communications configuration for the DeviceNet Communications Unit/Card.	---	83	Yes	No	Byte
	04	Produced connection ID	Indicates the label used for the communications header for the DeviceNet Communications Unit/Card. (See note 1.)	---	---	Yes	No	Word
	05	Consumed connection ID	* These are set when the communications connection is made.	---	---	Yes	No	Word
	06	Initial comm characteristics	Indicates the communications configuration for the DeviceNet Communications Unit/Card.	---	21	Yes	No	Byte
	07	Produced connection size	Indicates the maximum number of bytes for transmission.	---	0020	Yes	No	Word
	08	Consumed connection size	Indicates the maximum number of bytes for reception.	---	0020	Yes	No	Word

Instance	Attribute	Name	Content	Setting range	Default	Read	Write	Size
01 Explicit message	09	Expected packet rate	Indicates the length of the internal processing time-out when a communications request is received. Incremented by 10-ms units.	0 to 65,535 (ms)	09C4 (2,500 ms)	Yes	Yes	Word
	0C	Watchdog time-out action	Indicates the action for internal processing time-out related to communications. 00: Retain timeout status (until reset or cleared). 01: Cut connection automatically. 02: Operate again with same connection as is.	---	01	Yes	No	Byte
	0D	Produced connection path length	(No data for explicit messages.)	---	0000	Yes	No	Word
	0E	Produced connection path	(No data for explicit messages.)	---	---	Yes	No	Array
	0F	Consumed connection path length	(No data for explicit messages.)	---	0000	Yes	No	Word
	10	Consumed connection path	(No data for explicit messages.)	---	---	Yes	No	Array
02 03 04 Remote I/O (See note 2.)	01	State	Indicates the status of this object (instance). 00: Does not exist in network, or is not ready. 01: In network state, waiting for connection event from Master Unit. 02: Waiting for connection ID (attribute) writing. 03: Connection completed. 04: Timeout	---	Must be "03" when communications are established.	Yes	No	Byte
	02	Instance type	Indicates the type of object (instance). 00: Explicit message 01: Remote I/O	---	01	Yes	No	Byte
	03	Transport class trigger	Indicates the communications configuration for the DeviceNet Communications Unit/Card.	---	82	Yes	No	Byte
	04	Produced connection ID	Indicates the label used for the communications header for the DeviceNet Communications Unit/Card. (See note 1.) * These are set when the communications connection is made.	---	---	Yes	No	Word
	05	Consumed connection ID		---	---	Yes	No	Word
	06	Initial comm characteristics	Indicates the communications configuration for the DeviceNet Communications Unit/Card.	---	01	Yes	No	Byte
	07	Produced connection size	Indicates the maximum number of bytes for transmission.	---	See note 3.	Yes	No	Word

Instance	Attribute	Name	Content	Setting range	Default	Read	Write	Size
02 03 04 Remote I/O (See note 2.)	08	Consumed connection size	Indicates the maximum number of bytes for reception.	---	See note 3.	Yes	No	Word
	09	Expected packet rate	Indicates the length of the internal processing timeout when a communications request is received. Incremented by 10-ms units.	0 to 65,535 (ms)	0000 (0 ms)	Yes	Yes	Word
	0C	Watchdog timeout action	Indicates the action for internal processing timeout related to communications. 00: Retain timeout status (until reset or cleared).	---	00	Yes	No	Byte
	0D	Produced connection path length	Indicates number of bytes of data for produced connection path.	---	See note 3.	Yes	No	Word
	0E	Produced connection path	Indicates the data for defining the application object for sending this object (instance). * Has a function for switching the DeviceNet Communication Unit/ Card's remote I/O operation.	---	See note 3.	Yes	No	Array
	0F	Consumed connection path length	Indicates the number of bytes of data for the consumed connection path.	---	See note 3.	Yes	No	Word
	10	Consumed connection path	Indicates the data for defining the application object for receiving this object (instance). * Has a function for switching the DeviceNet Communication Unit/ Card's remote I/O operation.	---	See note 3.	Yes	No	Array

Note 1. “Produced” means output (Inverter to PLC), and “Consumed” means input (PLC to Inverter).

Note 2. Instance 02 is a Poll connection, Instance 03 is a Bit-strobe connection, and Instance 04 is a COS or Cyclic connection.

Note 3. The following table shows the connection path for each Instance.

●Produced Connection Path

Remote I/O function	Connection Size	Path Length	Connection Path	Remarks
46 hex: Basic remote I/O (input)	0004	0006	20 04 24 46 30 03	---
47 hex: Standard remote I/O (input)	0004	0006	20 04 24 47 30 03	Instance 02 default setting
96 hex: Special remote I/O (input)	0005	0006	20 04 24 96 30 03	---
97 hex: Control I/O remote I/O (input)	0008	0006	20 04 24 97 30 03	---

Remote I/O function	Connection Size	Path Length	Connection Path	Remarks
98 hex: Control I/O remote I/O + Unit status (input)	000A	0006	20 04 24 98 30 03	---
99 hex: Control I/O remote I/O + multi-function input monitor (input)	0009	0006	20 04 24 99 30 03	---
9A hex: Unit status (input)	0002	0006	20 04 24 9A 30 03	Instance 04 default setting
9B hex: Multi-function input monitor (input)	0001	0006	20 04 24 9B 30 03	---
No remote I/O function set.	0000	0000	---	Instance 03 default setting

● Consumed Connection Path

Remote I/O function	Connection Size	Path Length	Connection Path	Remarks
14 hex: Basic remote I/O (input)	0004	0006	20 04 24 14 30 03	
15 hex: Standard remote I/O (input)	0004	0006	20 04 24 15 30 03	Instance 02 default setting
64 hex: Special remote I/O (input)	0005	0006	20 04 24 64 30 03	---
65 hex: Control I/O remote I/O (input)	0008	0006	20 04 24 65 30 03	---
No remote I/O function set.	0000	0000	---	Instance 03 and Instance 04 default setting

10-2-6 Input Terminal Control Objects: Class 08 Hex

■ Support Service Code

Service code number (hex)	Service
05	Reset (return to initial status)
0E	Get attribute single
10	Set attribute single

■ Object Details

Instance	Attribute	Name	Content	Setting range	Default	Read	Write	Size
00	01	Object Software Revision	Indicates the software revision of Class 08. The revision value increases when changes have been made.	---	0002	Yes	No	Word
	02	Max Instance	Indicates the number of input terminals. (Depends on the Inverter being used.)	---	0007	Yes	No	Word
01 to 08 (one per terminal)	03	Value	Terminal status 00: OFF, 01: ON	---	00	Yes	No	Byte
	65	Lifetime mode selection	Maintenance count method 00: Conduction time, 01: Number of ON operations	00, 01	00	Yes	Yes	Byte
	66	Lifetime present value	Present value of the maintenance count	---	0000 0000	Yes	Yes Reset	Long
	67	Lifetime monitor flag	Maintenance count comparison result (ON when PV - threshold ≤ 0) 00: OFF, 01:ON	---	00	Yes	No	Byte
	68	Lifetime threshold setting	Lifetime monitor value Set the cumulative time that the input is ON (s) or the number of contact operations.	0000 0000 to FFFF FFFF	0000 0000	Yes	Yes	Long

10-2-7 : Class 09 Hex

■ Support Service Code

Service code number (hex)	Service
05	Reset (return to initial status)
0E	Get attribute single
10	Set attribute single

■ Object Details

Instance	Attribute	Name	Content	Setting range	Default	Read	Write	Size
00	01	Object Software Revision	Indicates the software revision of Class 08. The revision value increases when changes have been made.	---	0001	Yes	No	Word
	02	Max Instance	Indicates the number of output terminals. (Depends on the Inverter being used.)	---	0003	Yes	No	Word
01 to 03 (One per terminal)	03	Value	Terminal status 00: OFF, 01: ON	---	00	Yes	No	Byte
	05	Fault Action	Hold/clear output after fault 00: Hold, 01: Clear	00, 01	00	Yes	Yes	Byte
	65	Lifetime mode selection	Maintenance count method 00: Conduction time, 01: Number of ON operations	00, 01	00	Yes	Yes	Byte
	66	Lifetime present value	Present value of the maintenance count	---	0000 0000	Yes	Yes Reset	Long
	67	Lifetime monitor flag	Maintenance count comparison result (ON when PV ≥ threshold) 00: OFF, 01: ON	---	00	Yes	No	Byte
	68	Lifetime threshold setting	Lifetime monitor value Set the cumulative time that the output is ON (s) or the number of contact operations.	0000 0000 to FFFF FFFF	0000 0000	Yes	Yes	Long

10-2-8 Motor Data Objects: Class 28 Hex

Motor data objects are data and functions related to motors connected to Inverters. The motors that can be connected to Inverters are squirrel-cage inductive motors, so the “Motor Type” is always “7.” The motor’s rated current and rated voltage can be set and read.

■ Support Service Code

Service code number (hex)	Service
0E	Get attribute single
10	Set attribute single

■ Object Details

Instance	Attribute	Name	Content	Setting range	Default	Read	Write	Size
00	01	Object Software Revision	Indicates class 28 software revisions. The revision value is advanced whenever there is a change.	---	0001	Yes	No	Word
01	03	Motor Type	Indicates the type of motor to be used. The setting for a squirrel-cage inductive motor is 7.	---	07	Yes	No	Byte
	06	Motor Rated Current	The motor's rated current can be set and read. The setting unit is 0.1 A. (The setting unit can be changed using the current scale in Class 2A, Instance 1, Attribute 17.)	Inverter rated output current 10% to 120%	See note 1.	Yes	Yes	Word
	07	Motor Rated Voltage	The motor's rated voltage can be set and read. The setting unit is 1 V. (The setting unit can be changed using the voltage scale in Class 2A, Instance 1, Attribute 1B.)	0 to 255 V (0 to 510 V) (See note 2.)	00C8 (0190) (See note 2.)	Yes	Yes	Word

Note 1. The default setting for the motor's rated current depends on the Inverter model.
Example: 1.90A (0013 hex) for 200-V class, 0.4 kW

Note 2. The figures enclosed in parentheses in the "Setting range" and "Default" columns are the values for 400-V class Inverters.

10-2-9 Control Supervisor Objects: Class 29 Hex

Control supervisor objects are objects that have Inverter control I/O-related functions. They are assigned according to their particular control I/O functions, such as forward operation, reverse operation, error detection, and so on. Be careful when setting up a remote I/O communications connection. These functions are shared with similar functions used for remote I/O, so even if they have been set for message operations they may get rewritten for remote I/O.

■ Support Service Code

Service code number (hex)	Service
0E	Get attribute single
10	Set attribute single
05	Reset attribute: Can be sent to Class 29/Instance 01 Turns OFF the Forward Operation and Reverse Operation inputs and turns ON the Fault Reset. Then turns OFF the Fault Reset when Inverter Ready is output.

■ Object Details

Instance	Attribute	Name	Content	Setting range	Default	Read	Write	Size
00	01	Object Software Revision	Indicates class 29 software revisions. The revision value is advanced whenever there is a change.	---	0001	Yes	No	Word
01	03	Forward/Stop	00: Stop 01: Forward operation	00, 01	00	Yes	Yes	Byte
	04	Reverse/Stop	00: Stop 01: Reverse operation	00, 01	00	Yes	Yes	Byte
	05	Net Control Local/remote switch (Set note 1.)	00: Operation set in n003/b1-02. 01: Force DeviceNet operation (not valid with 3G3FV).	00, 01	00	Yes	Yes	Byte
	06	State Inverter status (See note 1.)	00 hex: Vendor specific 01 hex: Startup 02 hex: Not ready 03 hex: Inverter ready 04 hex: Enabled 05 hex: Stopping 06 hex: Fault_Stop 07 hex: Faulted	---	03	Yes	No	Byte
	07	During forward run	00: No Inverter output or operating in reverse. 01: Forward operation or DC braking Turns ON even for DC braking during reverse operation.	--	00	Yes	No	Byte
	08	During reverse run	00: No Inverter output or operating in forward. 01: Operating in reverse (reverse operation output status) Becomes "00" with DC braking.	--	00	Yes	No	Byte
	09	Inverter Ready	00: Preparing Initial processing/ not drive mode/ fault 01: Inverter ready Inverter can receive run command.	--	00	Yes	No	Byte
	0A	Fault	00: Normal 01: Fault	--	00	Yes	No	Byte
	0B	Alarm (minor fault)	00: Normal 01: Alarm (minor fault)	--	00	Yes	No	Byte
	0C	Fault Reset	00: Normal status 01: Fault reset	00, 01	00	Yes	Yes	Byte
	0D	Fault code	Indicates the contents of fault that occur. (See the fault code list on the following page.)	---	0000	Yes	No	Word
	0F	Control From Net Run signal input status (See note 2.)	00: Operating by a method other than DeviceNet that is set in n003/b1-02. 01: Operating by DeviceNet.	---	00	Yes	No	Byte
	10	DeviceNet Fault mode (See note 3.)	00: Stop operation. 01: Continue operation. 02: Maker's specifications	3G3MV: 00, 01 3G3RV: --- 3G3FV: ---	3G3MV: 00 3G3RV: 02 3G3FV: 02	Yes	Yes	Byte

Instance	Attribute	Name	Content	Setting range	Default	Read	Write	Size
01	11	Force Fault/Trip Communications external fault input	00: Normal operation 01: Communications external fault input	00, 01	00	Yes	Yes	Byte
	12	Force Status Communications external fault input status	00: Normal status 01: Communications external fault detected. (Inverter stopped with fault detection.)	---	00	Yes	No	Byte

Note 1. The following table shows the status of remote I/O output signals and operation indicated by the content of Attribute 06 (State, i.e., Inverter status).

Setting	Status	Condition
00 hex	Vendor specific	A condition other than the ones below.
01 hex	Startup: Preparation not complete (setting constants)	Inverter Ready signal is OFF.
02 hex	Not ready: Stopped (preparation complete)	Inverter Ready signal is ON and During Run signal is OFF.
03 hex	Inverter ready: Stopped (preparation complete)	Inverter Ready signal is ON and During Run signal is OFF.
04 hex	Enabled: Operating	During Run signal (control I/O) is ON.
05 hex	Stopping: Decelerating (Operating with both forward and reverse references equal to 0.)	Ctrl. From Net is ON, During Forward Run is OFF, During Reverse Run is OFF, and During Run is ON.
06 hex	Fault_Stop: Operating with fault detected	Alarm signal is ON.
07 hex	Faulted: Fault detected	Fault signal is ON.

Note 2. The Net Control and Control From Net functions cannot be changed during running.

Note 3. A DeviceNet Fault mode can be set from communications in the 3G3MV only; it cannot be changed from communications in the 3G3RV or 3G3FV. Set the fault mode in the Inverter's parameters.

● **Fault Codes**

DeviceNet error code	Operator display	Meaning
0000	---	Inverter normal
2120	GF	Ground fault
2130	SC	Short circuit
2200	OL2	Inverter overload
2220	OL1	Motor overload
2221	OL3	Overtorque detection 1
2222	OL4	Overtorque detection 2
2300	OC	Overcurrent
3130	PF	Input phase loss
	LF	Output phase loss
3210	OV	Main circuit overvoltage
3220	UV1	Undervoltage (main)
3222	UV3	Undervoltage (MC)
4200	OH	Overheat

DeviceNet error code	Operator display	Meaning
4210	OH1	Overheat
5110	UV2	Control power supply fault
5120	PUF	Fuse open
5300	OPR	Operator disconnection
6320	ERR	EEPROM write failure
7110	RR	Braking transistor failure
7112	RH	Braking resistor overheating
7301	PGO	PG is disconnected
7310	OS	Overspeed
	DEV	Speed deviation
7500	BUS	Communications error
9000	EF3	External fault (Terminal 3)
	EF4	External fault (Terminal 4)
	EF5	External fault (Terminal 5)
	EF6	External fault (Terminal 6)
	EF7	External fault (Terminal 7)
	EF8	External fault (Terminal 8)
	FF0	Communications external fault

10-2-10AC/DC Drive Objects: Class 2A Hex

AC/DC drive objects are assigned to command-related functions for drive devices such as Inverters and Servomotors. Command-related data reading and writing, monitor data reading, set data scale changes, and so on, are all enabled. These functions are shared with similar functions used for remote I/O, so even if they have been set for message operations they may get rewritten for remote I/O.

■ Support Service Code

Service code number (hex)	Service
0E	Get attribute single
10	Set attribute single

■ Object Details

Instance	Attribute	Name	Content	Setting range	Default	Read	Write	Size
00	01	Object Software Revision	Indicates class 2A software revisions. The revision value is advanced whenever there is a change.	---	0001	Yes	No	Word
01	03	At Reference	00: Stopped, accelerating or decelerating 01: At reference	---	00	Yes	No	Byte
	04	Net Reference (See note 1.)	00: Operate with setting in n004/b1-01. 01: Force DeviceNet operation (not valid in 3G3FV).	00, 01	00	Yes	Yes	Byte

Instance	Attribute	Name	Content	Setting range	Default	Read	Write	Size
01	06	Drive Mode	Set to parameter n002/A1-02. Some Inverters do not support the setting. 00: Open loop vector ([n002/A1-02] = 2) 01: V/f control ([n002/A1-02] = 0) 02: V/f control with PG (A1-02 = 1) 03: Flux vector control (A1-02 = 3) After changing the setting, the power must be turned OFF and then ON again to enable the new setting.	00 to 03	3G3MV: 01 3G3RV: 01 3G3FV: 00	Yes	Yes	Byte
	07	Speed Actual Rotational Speed Monitor (See notes 2 and 4.)	The output frequency monitor (U-02/U1-02) can be monitored in hexadecimal with the minimum unit as 1. The frequency monitor's minimum unit can be set by the frequency reference setting and display units in n035/o1-03. n035/o1-03 = 0: 0.01 Hz n035/o1-03 = 1: 0.01% (100%: Max. frequency.) n035/o1-03 = 2 to 39: 1 r/min n035/o1-03 = 40 to 3,999: Follow individual set values. When r/min units are being used, a multiplier can be set in attribute 16 (the Speed Scale setting).	---	0000	Yes	No	Word
	08	Speed Reference Rotational Speed Reference (See notes 2 and 4.)	Can be set and read in hexadecimal with the frequency reference minimum unit as 1. The frequency reference minimum unit can be set by the frequency reference setting and display units in n035/o1-03. n035/o1-03 = 0: 0.01 Hz n035/o1-03 = 1: 0.01% (100%: Max. frequency.) n035/o1-03 = 2 to 39: 1 r/min n035/o1-03 = 40 to 3,999: Follow individual set values. When r/min units are being used, a multiplier can be set in attribute 16 (the Speed Scale setting).	0 to max. frequency	0000	Yes	Yes	Word
	09	Current Actual	Can be referenced in hexadecimal with the output current monitor U-03/U1-03 minimum unit as 0.1 A. Setting the attribute 17 current scale enables a multiplication factor to be set.	---	0000	Yes	No	Word

Instance	Attribute	Name	Content	Setting range	Default	Read	Write	Size
01	0F	Power Actual	Can be referenced in hexadecimal with the output power monitor U-11/U1-08 minimum unit as 1 W. Setting the attribute 1A power scale enables a multiplication factor to be set.	---	0000	Yes	No	Word
	10	Input Voltage	Can be referenced in hexadecimal with the input voltage setting (200 or 400/E1-01) minimum unit as 1 V. Setting the attribute 1B voltage scale enables a multiplication factor to be set.	---	0000	Yes	No	Word
	11	Output Voltage	Can be referenced in hexadecimal with the output voltage monitor U-04/U1-06 minimum unit as 1 V. Setting the attribute 1B voltage scale enables a multiplication factor to be set.	---	0000	Yes	No	Word
	12	Accel Time	Can be set and read in hexadecimal with the acceleration time 1 n019/C1-01 and deceleration time 1 n020/C1-02 minimum unit as 1 ms. Depending on the acceleration/ deceleration time unit n018/C1-10 setting, numbers below 100 ms or 10 ms are truncated. Setting the attribute 1C time scale enables a multiplication factor to be set.	0.0 to 6,000.0 (0.00 to 600.00)	2710 hex (10.0 s)	Yes	Yes	Word
	13	Decel Time			2710 hex (10.0 s)	Yes	Yes	Word
	14	Low Speed Limit (See notes 2, 3, and 4.)	Can be set and read in hexadecimal with the frequency reference lower limit n034/d2-02 and the frequency reference upper limit n033/d2-01 minimum unit as 1 ms.	0 to 109% of maximum frequency	0000	Yes	Yes	Word
	15	High Speed Limit (See notes 2, 3, and 4.)	The minimum unit can be set by the frequency reference setting and display units in n035/o1-03. n035/o1-03 = 0: 0.01 Hz n035/o1-03 = 1: 0.01% (100%: Max. frequency.) n035/o1-03 = 2 to 39: 1 r/min n035/o1-03 = 40 to 3,999: Follow individual set values. When r/min units are being used, a multiplier can be set in attribute 16 (the Speed Scale setting).	0 to 110% of maximum frequency	0708 hex (1,800 r/min)	Yes	Yes	Word
	16	Speed scale	Speed data unit selection can be set and read. The speed data unit value is calculated as follows: Unit = 1 [r/min] x 1/2 ^a a: Speed scale set value Set a negative value as its 2's complement.	-15 to 15 (F1 to 0F hex)	00	Yes	Yes	Byte

Instance	Attribute	Name	Content	Setting range	Default	Read	Write	Size
01	17	Current scale	Current data unit selection can be set and read. The current data unit value is calculated as follows: Unit = 0.1 [A] x 1/2 ^b b: Current scale set value Set a negative value as its 2's complement.	-15 to 15 (F1 to 0F hex)	00	Yes	Yes	Byte
	1A	Power scale	Power data unit selection can be set and read. The power data unit value is calculated as follows: Unit = 1 [W] x 1/2 ^c c: Power scale set value Set a negative value as its 2's complement.	-15 to 15 (F1 to 0F hex)	00	Yes	Yes	Byte
	1B	Voltage scale	Voltage data unit selection can be set and read. The voltage data unit value is calculated as follows: Unit = 1 [V] x 1/2 ^d d: Voltage scale set value Set a negative value as its 2's complement.	-15 to 15 (F1 to 0F hex)	00	Yes	Yes	Byte
	1C	Time scale	Time data unit selection can be set and read. The time data unit value is calculated as follows: Unit = 1 [ms] x 1/2 ^e e: Voltage scale set value Set a negative value as its 2's complement.	-15 to 15 (F1 to 0F hex)	00	Yes	Yes	Byte
	1D	Reference From Net	00: Reference other than DeviceNet (n004/b1-01) 01: Operating with DeviceNet.	---	00	Yes	No	Byte
	64	Electric power	Average power value (W)	---	0000 0000	Yes	No	Long
	65	Electric power time scale	Power value measurement period (T) (reflected when power is turned ON) 00: 10 minutes 01: 30 minutes 02: 60 minutes	00 to 02	00	Yes	Yes	Byte
	6F	Specific alarm	Alarm code of the alarm or minor fault detected in the Inverter. For more details, refer to 8-5 <i>Inverter Alarms</i> .	---	0000	Yes	No	Word
	70	Specific error	Fault code of the fault detected in the Inverter. For more details, refer to 8-4 <i>Inverter Faults</i> .	---	00	Yes	No	Byte

Note 1. The Net Reference and Reference From Net functions cannot be changed during running.

Note 2. Under the DeviceNet protocol, the unit for the speed reference is always r/min. The number of motor poles (2 to 39) must be set in parameter n035/o1-03 (frequency reference setting and display units) when using DeviceNet (open network). After changing the unit setting, turn the power OFF and then ON again.

Note 3. Cannot be changed during running.

Note 4. If a frequency reference value has been already set and the frequency display unit is changed via the network, a frequency reference value higher than expected may result after unit conversion. After changing the frequency display unit, always check the frequency reference value before starting an operation.

● Communications Data Setting Examples

Example 1: Finding the communications data for outputting a frequency of 60 Hz with the following conditions set.

Number of poles set in n035/o1-03: 4

Speed scale (attribute 16): 0

- Converting frequency to rotational speed:
Frequency x 120 / number of poles = $60 \times 120 / 4 = 1,800$ r/min
- Converting rotational speed to minimum unit:
Rotational speed / unit = $1,800 / (1 \text{ r/min} \times 1/2^0) = 1,800$
- Converting communications data to hexadecimal: 1,800 (decimal) = 0708 (hex)

Example 2: Finding the communications data for outputting a frequency of 60 Hz with the following condition set.

Frequency setting in n035/o1-03: 0 (Cannot be set with DeviceNet protocol.)

- Converting frequency to minimum setting unit:
Frequency / minimum unit = $60 / 0.01 = 6,000$
- Converting communications data to hexadecimal: 6,000 (decimal) = 1770 (hex)

Example 3: Finding the communications data for setting a one-minute acceleration time with the following condition set.

Time scale (attribute 1C): -3 (FD hex)

- Matching the acceleration time unit: 1 minute = 60 seconds = 60,000 ms
- Converting acceleration time to minimum unit:
Acceleration time / unit = $60,000 / (1 \text{ ms} \times 1/2^{-3}) = 7,500$
- Converting communications data to hexadecimal: 7,500 (decimal) = 1D4C (hex)

● Communications Data Reference Example

In this example, the hexadecimal value 0BB8 that has been read is converted to frequency with the following conditions set.

Number of poles set in n035/o1-03: 4

Speed scale (attribute 16): 1

- Converting communications data to decimal: 0BB8 (hex) = 3,000 (decimal)
- Converting from minimum unit to r/min:
Communications data x unit = $3,000 \times (1 \text{ r/min} \times 1/2^1) = 1,500$ (r/min)

10-2-11 Unit Parameter Objects: Class 94 Hex

■ Support Service Code

Service code number (hex)	Service
0E	Get attribute single
10	Set attribute single

■ Object Details

Instance	Attribute	Name	Content	Setting range	Default	Read	Write	Size
01	64	Default connection path	Select one of the six connection paths: 00: Basic remote I/O 01: Standard remote I/O 02: Special remote I/O 03: Control I/O remote I/O 04: Control I/O remote I/O + Unit status 05: Control I/O remote I/O + Multi-function input monitor	00 to 05	01	Yes	Yes	Byte

10-2-12 Unit Manager Object: Class 95 Hex

■ Support Service Code

Service code number (hex)	Service
0E	Get attribute single
10	Set attribute single
16	(Save) Writes all of the connected device present values to EEPROM.

■ Object Details

Instance	Attribute	Name	Content	Setting range	Default	Read	Write	Size
00	01	Object Software Revision	Indicates the class 95 software revision. The revision value is increased whenever there is a change.	---	0001	Yes	No	Word
01	65	General status	Status information	---	---	Yes	No	Word
	71	Present Unit conduction time	Present value of the Unit's total ON time	---	---	Yes	No	Word
	72	Unit conduction time monitor flag	Reports the result of the comparison between the Unit's time monitor value and the present value.	---	---	Yes	No	Word
	73	Unit conduction time monitor setting	Sets the Unit's conduction time monitor value.	---	---	Yes	Yes	Word
	75	Lifetime data write	Saves the current status of the Communications Unit to EEPROM immediately. The same procedure is automatically run every 6 min.	---	---	Save	No	Word
	7C	Detail Info 1	Reads the Operating Time Exceeded Flags. First two bytes: Number of bytes in the rest of the array = 0001 Data byte: Bit 0: Fan operating time exceeded Bit 1: Electrolytic capacitor operating time exceeded (The corresponding flag is set to "1" when the operating time is exceeded.)	---	0001 00	Yes	No	Array
	7D	Detail Info 2	Reads the Warning Torque Monitor Flags. First two bytes: Number of bytes in the rest of the array = 0001 Data byte: Bit 0: Warning torque during acceleration/deceleration Bit 1: Warning torque during frequency coincidence (The corresponding flag is set to "1" when the warning torque is detected.)	---	0001 00	Yes	No	Array

Instance	Attribute	Name	Content	Setting range	Default	Read	Write	Size
01	7E	Detail Info 3	Reads the Operating Time Monitor Flags. First two bytes: Number of bytes in the rest of the array = 0001 Data byte: Bit 0: Instance 01 Bit 1: Instance 02 Bit 2: Instance 03 Bit 3: Instance 04 Bit 4: Instance 05 Bit 5: Instance 06 (A flag will be set to "1" when Class 97 Attribute 66 for the corresponding Instance equals "01".	---	0001 00	Yes	No	Array
	7F	Detail Info 4	Reads the Lifetime Monitor Flags. First two bytes: Number of bytes in the rest of the array = 0003 Data byte 1: Input Terminal Lifetime Flags Bit 0: Instance 01 Bit 1: Instance 02 Bit 2: Instance 03 Bit 3: Instance 04 Bit 4: Instance 05 Bit 5: Instance 06 (A flag will be set to "1" when Class 08 Attribute 67 for the corresponding Instance equals "01". Data byte 2: Reserved (00) Data byte 3: Output Terminal Lifetime Flags Bit 0: Instance 01 Bit 1: Instance 02 Bit 2: Instance 03 (A flag will be set to "1" when Class 09 Attribute 67 for the corresponding Instance equals "01".	---	0003 00 00 00	Yes	No	Array

Writing performed once every six minutes is taken care by the EM.

10-2-13 Equipment Manager Object: Class 97 Hex

■ Support Service Code

Service code number (hex)	Service
05	(Reset) Returns the Attribute's data to initial values.
0E	Get attribute single
10	Set attribute single

■ Object Details

Instance	Attribute	Name	Content	Setting range	Default	Read	Write	Size
00	01	Object Software Revision	Indicates the class 97 software revision. The revision value is increased whenever there is a change.	---	0001	Yes	No	Word
01 to 06 (See note 1.)	65	OUTPUT Response Time	Output response time (ms)	---	0000	Yes	No	Word
	66	Response Time exceed	Reports the result of the comparison between the monitor value and the measured value. (ON when output response time > monitor value.) 00: OFF, 01: ON	---	00	Yes	Reset	Byte
	67	OUT response monitor setting	Sets the output response time monitor value (ms)	0000 to FFFF	0000	Yes	Yes	Word
	68	Response peak value	Peak value of the output response time (ms)	---	0000	Yes	Reset	Word

● Operating Time Measurements (Measurement Patterns) of Instances 01 to 06

Instance	Operating time measurement triggers		Remarks
	Measurement start condition	Measurement stop condition	
Instance 01 (See note 2.)	Multi-function contact output = ON	Input 4 = ON	Output → Input
Instance 02 (See note 2.)	Multi-function output 1 = ON	Input 5 = ON	Output → Input
Instance 03	Input 2 = ON	Input 3 = ON	Input → Input
Instance 04	Input 4 = ON	Input 5 = ON	Input → Input
Instance 05	Input 0 = ON, input 1 = ON, or a run command is sent from the network	Input 4 = ON	Forward or Reverse run command → Input
Instance 06	Input 0 = ON, input 1 = ON, or a run command was sent from the network	Input 5 = ON	Forward or Reverse run command → Input

Note 1. The following table shows the meaning of “Input □” in a start or stop condition. When using the control I/O remote I/O function, the input bit will be turned ON not only when the terminal’s signal is ON, but also when the corresponding bit is turned ON from remote I/O. (The terminal’s ON/OFF status is logically ORed with the status of the bit sent through remote I/O.)

Name	Meaning		
	3G3MV	3G3RV	3G3FV
Input 0	Status of terminal S1 (multi-function input 1)	Status of terminal S1 (Forward/Stop)	Status of terminal 1 (Forward/Stop)
Input 1	Status of terminal S2 (multi-function input 2)	Status of terminal S2 (Reverse/Stop)	Status of terminal 2 (Reverse/Stop)
Input 2	Status of terminal S3 (multi-function input 3)	Status of terminal S3 (multi-function input 1 selection)	Status of terminal 3 (multi-function contact input 1)
Input 3	Status of terminal S4 (multi-function input 4)	Status of terminal S4 (multi-function input 2 selection)	Status of terminal 4 (multi-function contact input 2)

Name	Meaning		
	3G3MV	3G3RV	3G3FV
Input 4	Status of terminal S5 (multi-function input 5)	Status of terminal S5 (multi-function input 3 selection)	Status of terminal 5 (multi-function contact input 3)
Input 5	Status of terminal S6 (multi-function input 6)	Status of terminal S6 (multi-function input 4 selection)	Status of terminal 6 (multi-function contact input 4)

Note 2. Instances 01 and 02 will be enabled when using the control I/O remote I/O function and the following parameter settings have been made.

- 3G3MV:
Set a value of 18 (communications output) in parameters n057 and n058 (function selection for multi-function outputs 1 and 2).
- 3G3RV/3G3FV:
Set a value of F (not used) in parameters H2-01 and H2-02 (function selection for the multi-function contact output and multi-function output 1).

When these settings are made, the Inverter's control terminal outputs can be controlled from communications and those signals can be used as measurement start triggers.

10-3 DeviceNet Communications Response Time

This section describes communications response time when OMRON Master and Slave Units are being used. Use this section for reference when planning I/O timing. The equations provided here are valid under the following conditions:

- The Master Unit is operating with the scan list enabled.
- All of the required Slaves are participating in communications.
- No errors are being indicated at the Master Unit
- Messages are not being produced in the network (from another company's configurator, for example).

■ Communications Cycle Time

● One Master in Network

The following equations show the communications cycle time (TRM) when there is only one Master in the network. If the calculation result is less than 2 ms, the communications cycle time (TRM) will be considered as 2 ms.

$$T_{RM} = \Sigma \text{ Communications time for 1 Slave} \\ + \text{ High-density Unit processing time} \\ + \text{ Explicit message processing time} \\ + \text{ COS/Cyclic connection communications time} \\ + 0.01 \times N + 1.0 \text{ (ms)}$$

Note N = Number of Slaves.

Communications Time for 1 Slave

This is the time required for 1 Slave to perform communications. “Σ Communications time for 1 Slave” in the above equation represents the sum of the communications times for each Slave in the network. The equations used to calculate the communications time (TRS) for different types of Slave are given below.

Output Slaves with 8 or Less Bytes of Output

$$T_{RT} = 0.016 \times T_B \times S_{OUT1} + 0.11 \times T_B + 0.07 \text{ (ms)}$$

S_{OUT1} : The number of Output Slave output words
 T_B : The baud rate factor
 (500 kbps: $T_B = 2$; 250 kbps: $T_B = 4$; 125 kbps: $T_B = 8$)

Input Slaves with 8 or Less Bytes of Input

$$T_{RT} = 0.016 \times T_B \times S_{IN1} + 0.06 \times T_B + 0.05 \text{ (ms)}$$

S_{IN1} : The number of Input Slave input words
 T_B : The baud rate factor
 (500 kbps: $T_B = 2$; 250 kbps: $T_B = 4$; 125 kbps: $T_B = 8$)

Mixed I/O Slaves with 8 or Less Bytes of Both Input and Output

$$T_{RT} = 0.016 \times T_B \times (S_{OUT2} + S_{IN2}) + 0.11 \times T_B + 0.07 \text{ (ms)}$$

- S_{OUT2}: The number of Mixed I/O Slave output words
- S_{IN2}: The number of Mixed I/O Slave input words
- T_B: The baud rate factor
(500 kbps: T_B = 2; 250 kbps: T_B = 4; 125 kbps: T_B = 8)

Slaves with More than 8 Bytes of Input or Output (or Both)

$$T_{RT} = T_{OH} \times T_{\text{BYTE-IN}} \times B_{IN} \times T_{\text{BYTE-OUT}} \times B_{OUT} \text{ (ms)}$$

- T_{OH}: Protocol overhead
- T_{BYTE-IN}: Input byte transmission time
- B_{IN}: Number of input bytes
- T_{BYTE-OUT}: Output byte transmission time
- B_{OUT}: Number of output bytes

Baud rate	T _{OH}	T _{BYTE-IN}	T _{BYTE-OUT}
500 kbps	0.306 ms	0.040 ms	0.036 ms
250 kbps	0.542 ms	0.073 ms	0.069 ms
125 kbps	1.014 ms	0.139 ms	0.135 ms

Note Calculate with B_{OUT} = 0 for Slaves with inputs only and B_{IN} = 0 for Slaves with outputs only.

High-density Unit Processing Time

Add 3.5 ms if there is at least 1 Slave with more than 8 bytes of input or output (or both).

Explicit Message Processing Time

Add the following explicit message processing time when performing explicit message communications (sending or receiving).

$$\text{Explicit message processing time} = 0.11 \times T_B \times n \text{ (ms)}$$

- n: The number of explicit messages that are sent or received within 1 cycle of the CPU Unit
- T_B: The baud rate factor
(500 kbps: T_B = 2; 250 kbps: T_B = 4; 125 kbps: T_B = 8)

COS/Cyclic Connection Communications Time

Add the following COS/cyclic connection communications time.

$$\text{COS/cyclic connection communications time} = (0.05 + 0.008 \times S) \times T_B \times n \text{ (ms)}$$

- S: The total number of input and output bytes for COS/cycle connections
- T_B: The baud rate factor
(500 kbps: T_B = 2; 250 kbps: T_B = 4; 125 kbps: T_B = 8)
- n: The number of nodes for which COS/cyclic connections occur within 1 cycle of the CPU Unit

● **More than One Master in Network**

Calculate the communications cycle time according to the above equation for the Slaves of each Master Unit. The communications cycle time for the entire network is the sum of communications cycle times for each Master Unit.

■ I/O Response Time of Inverter

The following shows processing time between the Inverter and the DeviceNet Communications Unit/Card.

- DP-RAM processing time between the Inverter and DeviceNet Communications Unit/Card: 8 ms in the 3G3MV and 5ms in the 3G3RV/3G3FV.
- Inverter input scanning: 5 ms (read twice)
- Inverter output scanning: 5 ms
- Inverter parameters scanning: 20 ms

● Inverter I/O Response Time

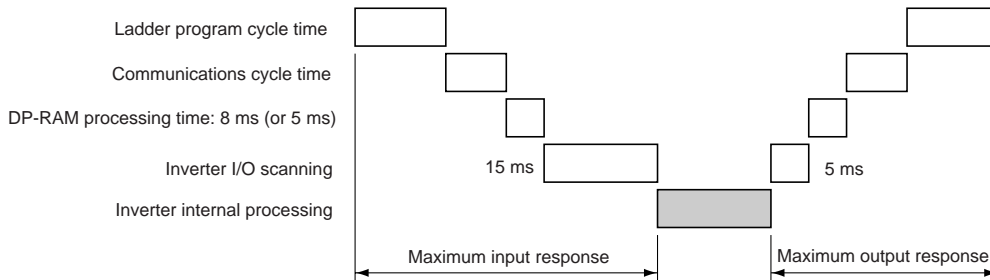

Note 1. The internal processing time varies depending on the controls to be executed.

Note 2. Input scanning for parameter reading or writing requires 20 ms.

10-4 3G3MV Register Numbers, Classes, Instances, and Attributes

10-4-1 Inputting Control/Frequency

The Inverter's various control inputs are allocated to the registers shown in the following table. For example, to set the frequency reference and begin operation, first set the reference value to the frequency reference register "0002," and then write the run command to the Inverter's run command register "0001."

Note 1. Set values are retained until changed by the next writing operation.

Note 2. The following registers are in RAM, so they are all cleared to zero when the Inverter's power supply is turned OFF.

Note 3. When the remote I/O function is being used, the run command and frequency reference are overwritten at regular intervals.

Class 64		Register number (hex)	Function	Content
Instance	Attribute			
---	---	0000	Not used.	---
00	01	0001	Run command	Refer to the following <i>Run Commands</i> table.
00	02	0002	Frequency reference	Frequency reference value setting (units as specified in n035)
00	03	0003	V/f gain	Make settings with 1000 decimal as 100%. (See note 1.) Setting range: 2.0 to 200.0% (20 to 2000 decimal)
---	---	0004 to 0008	Not used.	---
00	09	0009	Inverter output	Refer to following <i>Inverter Outputs</i> table.
---	---	000A to 000F	Not used.	---

Note 1. The V/f gain is the setting for the percentage of the V/f calculation result with respect to the output voltage. A setting of 1000 decimal (03E8 hex) corresponds to a multiplication factor of 1.

Note 2. When these registers are read, the values set in communications will be read. For example, when an operation command (register number 0001) is read, the control input previously set in communications will be returned. It is not a monitor for the actual terminal block input signals.

● Run Commands: Register Number 0001 Hex

Bit	Content
0	Forward/stop (1: forward operation)
1	Reverse/stop (1: reverse operation)
2	Multi-function input 3 (set with n052)
3	Multi-function input 4 (set with n053)
4	Multi-function input 5 (set with n054)
5	Multi-function input 6 (set with n055)
6	Multi-function input 7 (set with n056)

Bit	Content
7	Not used.
8	External fault input (1: EFO)
9	Fault reset (1: reset)
10 to 15	Not used.

● Inverter Outputs: Register Number 0009 Hex

Bit	Content
0	Multi-function contact output (1: ON)
1	Multi-function output 1 (1: ON)
2	Multi-function output 2 (1: ON)
3 to 15	Not used.

Note Valid when “18” (communications output) is set for multiple-function outputs 1 to 3 (n057 to n059). By performing this setting, the relevant output terminal can be turned ON and OFF through communications.

10-4-2 Inverter Monitoring Functions

All Inverter monitoring can be accessed. To read Inverter status, fault monitoring, alarm monitoring, I/O status monitoring, error log, etc., specify the register number from the following table and read the data.

Class 64		Register number (hex)	Function	Content
Instance	Attribute			
00	20	0020	Status signal	Refer to the following <i>Status Signals</i> table.
00	21	0021	Fault status	Refer to the following <i>Fault Status</i> table.
00	22	0022	Data link status	Refer to the following <i>Data Link Status</i> table.
00	23	0023	Frequency reference	Follows setting for n035.
00	24	0024	Output frequency	Follows setting for n035.
00	---	0025 to 0027	Not used.	---
00	28	0028	Output voltage	Read with 1 (V) = 1 decimal
00	29	0029	Fault status 2	Refer to the following <i>Fault Status 2</i> table
00	2A	002A	Warning status	Refer to the following <i>Warning Status</i> table
00	2B	002B	Input terminal status	Refer to the following <i>Input Terminal Status</i> table.
00	2C	002C	Inverter status	Refer to the following <i>Inverter Status</i> table.
00	2D	002D	Output terminal status	Refer to the following <i>Output Terminal Status</i> table.
00	2E	002E	Inverter status 2	Refer to the following <i>Inverter Status 2</i> table
00	---	002F to 0030	Not used.	---
00	31	0031	Main circuit DC voltage	Read with 1 (V) = 1 decimal
00	32	0032	Torque reference	Read with 1 (%) = 1 decimal Rated motor torque = 100%. Read with +/-.
00	---	0033 to 0034	Not used.	---

Class 64		Register number (hex)	Function	Content
Instance	Attribute			
00	35	0035	Accumulated operating time	Read with 1 (h) = 1 decimal
00	36	0036	Not used.	---
00	37	0037	Output power	Read with 1 (kW) = 100 decimal Read with +/-.
00	38	0038	PID feedback	Read with 1 (%) = 10 decimal Maximum frequency corresponds to 100%.
00	39	0039	PID input	Read with 1 (%) = 10 decimal Maximum frequency corresponds to 100%. Read with +/-.
00	3A	003A	PID output	Read with 1 (%) = 10 decimal Maximum frequency corresponds to 100%. Read with +/-.
00	3B	003B	Output current	Read with 1 (A) = 10 decimal Read with +/-
00	3C	003C	Not used.	---
00	3D	003D	Communications error content	Refer to the following <i>Communications Error Content</i> table.
00	---	003E to 00FF	Not used.	---

● **Status Signals: Register Number 0020 Hex**

Bit	Content
0	During Run (1: During Run)
1	Forward/reverse operation (1: reverse operation)
2	Inverter ready (1: ready)
3	Fault (1: fault)
4	Data setting error (1: error)
5	Multi-function output 1 (1: ON)
6	Multi-function output 2 (1: ON)
7	Multi-function output 3 (1: ON)
8 to 15	Not used.

● **Fault Status: Register Number 0021 Hex**

Bit	Content
0	OC
1	OV
2	OL2
3	OH
4	Not used.
5	Not used.
6	FBL
7	EF□, STP
8	F□
9	OL1
10	OL3

Bit	Content
11	UL3
12	UV1
13	UV2
14	CE
15	OPR

Note If an error is generated, the relevant bit will become 1.

● **Data Link Status: Register Number 0022 Hex**

Bit	Content
0	During data write (1: during write)
1 to 2	Not used.
3	Upper/lower limit error (1: error): setting range exceeded
4	Integration error (1: error): same as OPE□
5 to 15	Not used.

● **Fault Status 2: Register Number 0029 Hex**

Bit	Content
0	SC
1	GF
2	PF
3	LF
4 to 15	Not used.

● **Warning Status: Register Number 002A Hex**

Bit	Content
0	STP (Operator stop)
1	SER
2	EF
3	BB
4	OL3
5	OH
6	OV
7	UV
8	FAN
9	CE
10	BUS
11	Not used.
12	OH3
13	FBL
14	STP (Emergency stop)
15	Not used.

● **Input Terminal Status: Register Number 002B Hex**

Bit	Content
0	Multi-function input 1 terminal S1 (1: ON)
1	Multi-function input 2 terminal S2 (1: ON)
2	Multi-function input 3 terminal S3 (1: ON)
3	Multi-function input 4 terminal S4 (1: ON)
4	Multi-function input 5 terminal S5 (1: ON)
5	Multi-function input 6 terminal S6 (1: ON)
6	Multi-function input 7 terminal S7 (1: ON)
7 to 15	Not used.

● **Inverter Status: Register Number 002C Hex**

Bit	Content
0	During Run (1: During Run)
1	Zero speed (1: zero speed)
2	Frequency agree (1: frequency agree)
3	Warning (minor fault) (1: alarm)
4	Frequency detection 1 (1: output frequency \leq n095)
5	Frequency detection 2 (1: output frequency \geq n095)
6	Inverter ready (1: ready)
7	UV (1: UV)
8	Baseblock (1: during baseblock)
9	Frequency reference mode (1: not communications)
10	RUN command mode (1: not communications)
11	Overtorque detection (1: over torque detection)
12	Not used.
13	Fault retry (1: fault retry)
14	Fault (1: fault)
15	Communications timeout: over 2 s without normal communications (1: communications timeout detected)

● **Output Terminal Status: Register Number 002D Hex**

Bit	Content
0	Multi-function contact output terminal MA (1: ON)
1	Multi-function photocoupler output 1 terminal P1 (1: ON)
2	Multi-function photocoupler output 2 terminal P2 (1: ON)
3 to 15	Not used.

● **Inverter Status 2: Register Number 002E Hex**

Bit	Content
0	Frequency reference loss (1: loss)
1 to 15	Not used.

● **Communications Error Content: Register Number 003D Hex**

Bit	Content
0	CRC error (1: error)
1	Incorrect data length (1: error)
2	Not used.
3	Parity error (1: error)
4	Overrun error (1: error)
5	Framing error (1: error)
6	Communications timeout (1: error)
7 to 15	Not used.

10-4-3 Parameter Reading and Writing

The following tables show the SYSDRIVE 3G3MV Inverter parameter classes, instances and attributes, and the corresponding register numbers. Write and read the various parameters with “1” as the minimum setting unit. Negative numbers are expressed as two's complements. When parameters are written, the settings for parameters that can be written during operation become valid after the being set in RAM, whereas the settings for parameters that cannot be written during operation, become valid from the next operation. Send an enter command to save the set data in EEPROM.

Note The 2 register numbers that are different from RS-422/485 communications are indicated by shading (refer to page 10-39).

■ **Function Group 1 (n001 to n049)**

Con-stant	Register number (hex)	Class 64 (hex)		Name	Setting range	Setting unit	Default setting	Write during operation
		In-stance	At-tribute					
n001	0101	01	01	Parameter write-prohibit selection/parameter initialization	0 to 9	1	1	No
n002	0102	01	02	Control mode selection	0: V/f control 2: Vector control (See note 1.)	1	0	No
n003	0103	01	03	Run command selection	0 to 3	1	0	No
n004	0104	01	04	Frequency reference selection	0 to 9	1	0	No
n005	0105	01	05	Stopping method selection	0, 1	1	0	No
n006	0106	01	06	Reverse rotation-prohibit selection	0, 1	1	0	No
n007	0107	01	07	STOP Key function selection	0, 1	1	0	No
n008	0108	01	08	Frequency reference selection in local mode	0, 1	1	0	No
n009	0109	01	09	Operator frequency setting method selection	0, 1	1	0	No
n010	010A	01	0A	Operation selection at Digital Operator interruption	0, 1	1	0	No
n011	010B	01	0B	Maximum frequency (FMAX)	50.0 to 400.0	0.1 Hz	60.0	No
n012	010C	01	0C	Maximum voltage (VMAX)	0.1 to 255.0 [0.1 to 510.0] (See note 2.)	0.1 V	200.0 [400.0] (See note 2.)	No

Note 1. These settings are valid only when changing the parameter via DeviceNet. Refer to manual I527 for settings that can be made via RS-422/485 communications or the front panel.

Note 2. [] values indicate those for 400-V-class Inverters.

Constant	Register number (hex)	Class 64 (hex)		Name	Setting range	Setting unit	Default setting	Write during operation
		Instance	Attribute					
n013	010D	01	0D	Maximum voltage frequency (FA)	0.2 to 400.0	0.1 Hz	60.0	No
n014	010E	01	0E	Middle output frequency (FB)	0.1 to 399.9	0.1 Hz	1.5	No
n015	010F	01	0F	Middle output frequency voltage (VC)	0.1 to 255.0 [0.1 to 510.0]	0.1 V	12.0 [24.0]	No
n016	0110	01	10	Minimum output frequency (FMIN)	0.1 to 10.0	0.1 Hz	1.5	No
n017	0111	01	11	Minimum output frequency voltage (VMIN)	0.1 to 50.0 [0.1 to 100.0]	0.1 V	12.0 [24.0]	No
n018	0112	01	12	Acceleration/Deceleration time setting unit	0, 1	1	0	No
n019	0113	01	13	Acceleration time 1	0.0 to 6000	0.1 s (set with n018)	10.0	Yes
n020	0114	01	14	Deceleration time 1			10.0	Yes
n021	0115	01	15	Acceleration time 2			10.0	Yes
n022	0116	01	16	Deceleration time 2			10.0	Yes
n023	0117	01	17	S-shape acceleration/deceleration characteristic	0 to 3	1	0	No
n024	0118	01	18	Frequency reference 1	0.00 to maximum frequency	0.01 Hz (set with n035)	6.00	Yes
n025	0119	01	19	Frequency reference 2			0.00	Yes
n026	011A	01	1A	Frequency reference 3			0.00	Yes
n027	011B	01	1B	Frequency reference 4			0.00	Yes
n028	011C	01	1C	Frequency reference 5			0.00	Yes
n029	011D	01	1D	Frequency reference 6			0.00	Yes
n030	011E	01	1E	Frequency reference 7			0.00	Yes
n031	011F	01	1F	Frequency reference 8			0.00	Yes
n032	0120	01	20	Inching frequency command			6.00	Yes
n033	0121	01	21	Upper frequency reference limit	0 to 110	1%	100	No
n034	0122	01	22	Lower frequency reference limit	0 to 110	1%	0	No
n035	0123	01	23	Frequency reference setting/display unit selection	0 to 3999	1	0	No
n036	0124	01	24	Rated motor current	0 to 150% of the rated output current	0.1 A	Differs with capacity	No
n037	0125	01	25	Motor protection characteristics	0 to 2	1	0	No
n038	0126	01	26	Motor protective time setting	1 to 60	1 min	8	No
n039	0127	01	27	Cooling fan operation	0, 1	1	0	No
n040	0128	01	28	Motor rotation direction selection	0, 1	1	0	No
n041	0129	01	29	Acceleration time 3	0.0 to 6000	0.1 s (set with n018)	10.0	Yes
n042	012A	01	2A	Deceleration time 3			10.0	Yes
n043	012B	01	2B	Acceleration time 4			10.0	Yes
n044	012C	01	2C	Deceleration time 4			10.0	Yes
n045 to n049	---	---	---	Not used.	---	---	---	---

Note [] values indicate those for 400-V-class Inverters.

■ Function Group 2 (n050 to n079)

Constant	Register number (hex)	Class 64 (hex)		Name	Setting range	Setting unit	Default setting	Write during operation
		Instance	Attribute					
n050	0132	01	32	Multi-function input 1 (terminal S1)	1 to 27	1	1	No
n051	0133	01	33	Multi-function input 2 (terminal S2)	1 to 27	1	2	No
n052	0134	01	34	Multi-function input 3 (terminal S3)	0 to 27	1	3	No
n053	0135	01	35	Multi-function input 4 (terminal S4)	1 to 27	1	5	No
n054	0136	01	36	Multi-function input 5 (terminal S5)	1 to 27	1	6	No
n055	0137	01	37	Multi-function input 6 (terminal S6)	1 to 27	1	7	No
n056	0138	01	38	Multi-function input 7 (terminal S7)	1 to 27, 34, 35	1	10	No
n057	0139	01	39	Multi-function input 1 (MA/MB-MC)	0 to 21	1	0	No
n058	013A	01	3A	Multi-function input 2 (P1-PC)	0 to 21	1	1	No
n059	013B	01	3B	Multi-function input 3 (P2-PC)	0 to 21	1	2	No
n060	013C	01	3C	Frequency reference gain	0 to 255	1%	100	Yes
n061	013D	01	3D	Frequency reference bias	-100 to 100	1%	0	Yes
n062	013E	01	3E	Analog frequency reference filter time constant	0.00 to 2.00	0.01 s	0.10	Yes
n063	---	---	---	Not used.	---	---	---	---
n064	0140	01	40	Frequency reference loss detection selection	0, 1	1	0	No
n065	0141	01	41	Multi-function analog output type selection	0, 1	1	0	No
n066	0142	01	42	Multi-function analog output	0 to 6	1	0	No
n067	0143	01	43	Multi-function analog output gain	0.00 to 2.00	0.01	1.00	Yes
n068	0144	01	44	Multi-function analog voltage input gain	-255 to 255	1%	100	Yes
n069	0145	01	45	Multi-function analog voltage input bias	-100 to 100	1%	0	Yes
n070	0146	01	46	Multi-function analog voltage input filter constant	0.00 to 2.00	0.01 s	0.10	Yes
n071	0147	01	47	Multi-function analog current input gain	-255 to 255	1%	100	Yes
n072	0148	01	48	Multi-function analog current input bias	-100 to 100	1%	0	Yes
n073	0149	01	49	Multi-function analog current input filter constant	0.00 to 2.00	0.01 s	0.10	Yes
n074	014A	01	4A	Pulse train frequency reference gain	-255 to 255	1%	100	Yes
n075	014B	01	4B	Pulse train frequency reference bias	-100 to 100	1%	0	Yes
n076	014C	01	4C	Pulse train frequency reference input filter constant	0.00 to 2.00	0.01 s	0.10	Yes
n077	014D	01	4D	Multi-function analog input terminal function selection	0 to 4	1	0	No
n078	014E	01	4E	Multi-function analog input terminal selection	0, 1	1	0	No
n079	014F	01	4F	Multi-function analog input frequency bias	0 to 50	1%	10	No

■ Function Group 3 (n080 to n119)

Constant	Register number (hex)	Class 64 (hex)		Name	Setting range	Setting unit	Default setting	Write during operation
		Instance	Attribute					
n080	0150	01	50	Carrier frequency selection	1 to 4, 7 to 9	1	Differs with capacity.	No
n081	0151	01	51	Momentary power interruption compensation	0 to 2	1	0	No
n082	0152	01	52	Number of fault retries	0 to 10	1	0	No
n083	0153	01	53	Jump frequency 1	0.00 to 400.0	0.01 Hz	0.00	No
n084	0154	01	54	Jump frequency 2	0.00 to 400.0	0.01 Hz	0.00	No
n085	0155	01	55	Jump frequency 3	0.00 to 400.0	0.01 Hz	0.00	No
n086	0156	01	56	Jump width	0.00 to 25.50	0.01 Hz	0.00	No
n087	0157	01	57	Cumulative operation time selection	0, 1	1	0	No
n088	0158	01	58	Cumulative operation time	0 to 6550	1 (10 h)	0	No
n089	0159	01	59	DC injection braking current	0 to 100	1%	50	No
n090	015A	01	5A	DC injection braking-to-stop time	0.0 to 25.5	0.1 s	0.5	No
n091	015B	01	5B	Startup DC injection braking time	0.0 to 25.5	0.1 s	0.0	No
n092	015C	01	5C	Stall prevention during deceleration	0, 1	1	0	No
n093	015D	01	5D	Stall prevention level during acceleration	30 to 200	1%	170	No
n094	015E	01	5E	Stall prevention level during operation	30 to 200	1%	160	No
n095	015F	01	5F	Frequency detection level	0.00 to 400.0	0.01 Hz	0.00	No
n096	0160	01	60	Overtorque detection function selection 1	0 to 4	1	0	No
n097	0161	01	61	Overtorque detection function selection 2	0, 1	1	0	No
n098	0162	01	62	Overtorque detection level	30 to 200	1%	160	No
n099	0163	01	63	Overtorque detection time	0.1 to 10.0	0.1 s	0.1	No
n100	0164	01	64	UP/DOWN frequency selection	0, 1	1	0	No
n101	0165	01	65	Speed search deceleration time	0.0 to 10.0	0.1 s	2.0	No
n102	0166	01	66	Speed search level	0 to 200	1%	150	No
n103	0167	01	67	Torque compensation gain	0.0 to 2.5	0.1	1.0	Yes
n104	0168	01	68	Torque compensation primary delay time constant	0.0 to 25.5	0.1 s	0.3	No
n105	0169	01	69	Torque compensation core loss	0.0 to 6550	0.1 W	Differs with capacity.	No
n106	016A	01	6A	Rated motor slip	0.0 to 20.0	0.1 Hz	Differs with capacity.	Yes
n107	016B	01	6B	Motor phase-to-neutral resistance	0.000 to 65.50	0.001 Ω	Differs with capacity.	No

Con- stant	Regis- ter num- ber (hex)	Class 64 (hex)		Name	Setting range	Setting unit	Default setting	Write during opera- tion
		In- stance	At- tribute					
n108	016C	01	6C	Motor leakage inductance	0.00 to 655.0	0.01 mH	Differs with capacity.	No
n109	016D	01	6D	Torque compensation limit	0 to 250	1%	150	No
n110	016E	01	6E	Motor no-load current	0 to 99	1%	Differs with capacity.	No
n111	016F	01	6F	Slip compensation gain	0.0 to 2.5	0.1	0.0	Yes
n112	0170	01	70	Slip compensation primary delay time	0.0 to 25.5	0.1 s	2.0	No
n113	0171	01	71	Slip compensation during regeneration	0, 1	1	0	No
n114	---	---	---	Not used.	---	---	---	---
n115	0173	01	73	Stall prevention level automatic sup- pression selection	0, 1	1	0	No
n116	0174	01	74	Stall prevention acceleration/decelera- tion time setting	0, 1	1	0	No
n117	0175	01	75	Low torque detection selection	0 to 4	1	0	No
n118	0176	01	76	Low torque detection level	0 to 200	1%	10	No
n119	0177	01	77	Low torque detection time	0.1 to 10.0	0.1 s	0.1	No

■ Function Group 4 (n120 to n179)

Con- stant	Regis- ter num- ber (hex)	Class 64 (hex)		Name	Setting range	Setting unit	Default setting	Write during opera- tion
		In- stance	At- tribute					
n120	0178	01	78	Frequency reference 9	0.00 to maxi- mum fre- quency	0.01 Hz (set with n035)	0.00	Yes
n121	0179	01	79	Frequency reference 10			0.00	Yes
n122	017A	01	7A	Frequency reference 11			0.00	Yes
n123	017B	01	7B	Frequency reference 12			0.00	Yes
n124	017C	01	7C	Frequency reference 13			0.00	Yes
n125	017D	01	7D	Frequency reference 14			0.00	Yes
n126	017E	01	7E	Frequency reference 15			0.00	Yes
n127	017F	01	7F	Frequency reference 16			0.00	Yes
n128	01D3	01	D3	PID control selection	0 to 8	1	0	No
n129	01D4	01	D4	Feedback value adjustment gain	0.00 to 10.00	0.01	1.00	Yes
n130	0182	01	82	Proportional gain (P)	0.0 to 25.0	0.1	1.0	Yes
n131	0183	01	83	Integral time (I)	0.0 to 360.0	0.1 s	1.0	Yes
n132	0184	01	84	Derivative time (D)	0.00 to 2.50	0.01 s	0.00	Yes
n133	0185	01	85	PID offset adjustment	-100 to 100	1%	0	Yes
n134	0186	01	86	Integral (I) upper limit	0 to 100	1%	100	Yes
n135	0187	01	87	PID primary delay time	0.0 to 10.0	0.1 s	0.0	Yes
n136	0188	01	88	Feedback loss detection selection	0 to 2	1	0	No
n137	0189	01	89	Feedback loss detection level	0 to 100	1%	0	No

Constant	Register number (hex)	Class 64 (hex)		Name	Setting range	Setting unit	Default setting	Write during operation
		Instance	Attribute					
n138	018A	01	8A	Feedback loss detection time	0.0 to 25.5	0.1 s	1.0	No
n139	018B	01	8B	Energy-saving control selection	0, 1	1	0	No
n140	018C	01	8C	Energy-saving control coefficient K2	0.0 to 6550	0.1	Differs with capacity.	No
n141	018D	01	8D	Energy-saving voltage lower limit at 60-Hz output	0 to 120	1%	50	No
n142	018E	01	8E	Energy-saving voltage lower limit at 6-Hz output	0 to 25	1%	12	No
n143	018F	01	8F	Power averaging time	1 to 200	1 (24 ms)	1	No
n144	0190	01	90	Probe operation voltage limit	0 to 100	1%	0	No
n145	0191	01	91	Probe operation control voltage step at 100%	0.1 to 10.0	0.1%	0.5	No
n146	0192	01	92	Probe operation control voltage step at 5%	0.1 to 10.0	0.1%	0.2	No
n147	---	---	---	Not used.	---	---	---	---
n148								
n149	0195	01	95	Pulse train input scale	100 to 3300	1 (10 Hz)	2500	No
n150	0196	01	96	Multi-function analog output, pulse train frequency selection	0, 1, 6, 12, 24, 36, 40 to 45	1	0	No
n151	0197	01	97	RS-422/485 communications time-over detection selection	0 to 4	1	0	No
n152	0198	01	98	RS-422/485 communications frequency reference/monitor unit selection	0 to 3	1	0	No
n153	0199	01	99	RS-422/485 communications slave address (read only)	00 to 32	1	00	No
n154	019A	01	9A	RS-422/485 baud rate selection (read only)	0 to 3	1	2	No
n155	019B	01	9B	RS-422/485 parity selection (read only)	0 to 2	1	0	No
n156	019C	01	9C	RS-422/485 send wait time (read only)	10 to 65	1 ms	10	No
n157	019D	01	9D	RS-422/485 RTS control selection	0, 1	1	0	No
n158	019E	01	9E	Motor code	0 to 70	1	Differs with capacity.	No
n159	019F	01	9F	Energy-saving voltage upper limit at 60-Hz output	0 to 120	1%	120	No
n160	01A0	01	A0	Energy-saving upper limit voltage at 6-Hz output	0 to 25	1%	16	No
n161	01A1	01	A1	Power detection width for probe operation switching	0 to 100	1%	10	No
n162	01A2	01	A2	Power detection filter constant	0 to 255	1 (4 ms)	5	No
n163	01A3	01	A3	PID output gain	0.0 to 25.0	0.1	1.0	No
n164	01A4	01	A4	PID feedback input block selection	0 to 5	1	0	No
n165	---	---	---	Not used.	---	---	---	---
n166	01A6	01	A6	Open input phase detection level	0 to 100	1%	0	No
n167	01A7	01	A7	Open input phase detection time	0 to 255	1 s	0	No
n168	01A8	01	A8	Open output phase detection level	0 to 100	1%	0	No

Con-stant	Regis-ter num-ber (hex)	Class 64 (hex)		Name	Setting range	Setting unit	Default setting	Write during operation
		In-stance	At-tribute					
n169	01A9	01	A9	Open output phase detection time	0.0 to 2.0	0.1 s	0.0	No
n170 to n172	---	---	---	Not used.	---	---	---	---
n173	01AD	01	AD	DC injection braking proportional gain	1 to 999	1 (0.001)	83	No
n174	01AE	01	AE	DC injection braking integration time	1 to 250	1 (4 ms)	25	No
n175	01AF	01	AF	Low carrier frequency at low speed	0, 1	1	0	No
n176	01B0	01	B0	Parameter copy and verify function selection (read only)	0 to 5	1	0	No
n177	01B1	01	B1	Parameter read prohibit selection (read only)	0, 1	1	0	No
n178	01B2	01	B2	Fault log (read only)	---	---	---	---
n179	01B3	01	B3	Software number (read only)	---	---	---	---

10-5 3G3RV Register Numbers, Classes, Instances, and Attributes

10-5-1 Inputting Control/Frequency (Read/Write)

The Inverter's various control inputs are allocated to the registers shown in the following table. For example, to set the frequency reference and begin operation, first set the reference value to the frequency reference register "0002," and then write the run command to the Inverter's run command register "0001."

Note 1. Set values are retained until changed by the next writing operation.

Note 2. The following registers are in RAM, so they are all cleared to zero when the Inverter's power supply is turned OFF.

Note 3. When the remote I/O function is being used, the run command and frequency reference are overwritten at regular intervals.

Class 64		Register number (hex)	Content	
Instance	Attribute			
---	---	0000	Reserved	
00	01	0001	Frequency reference	
			Bit 0	Run/stop command 1: Run 0: Stop
			Bit 1	Reverse/stop command 1: Reverse 0: Stop
			Bit 2	Multi-function input command 3
			Bit 3	Multi-function input command 4
			Bit 4	Multi-function input command 5
			Bit 5	Multi-function input command 6
			Bit 6	Multi-function input command 7
			Bit 7	Not used.
			Bit 8	External error 1: Error (EFO)
			Bit 9	Error reset 1: Reset command
Bit 10 to 15	Not used.			
00	02	0002	Frequency reference (Set units using parameter o1-03.)	
---	---	0003 to 0005	Not used.	
00	06	0006	PID target value	
00	07	0007	Analog output 1 setting (-11 V/-726 decimal to 11 V/726 decimal)	
00	08	0008	Analog output 2 setting (-11 V/-726 decimal to 11 V/726 decimal)	
00	09	0009	Multi-function contact output setting	
			Bit 0	Contact output (terminal M1-M2) 1: ON 0: OFF
			Bit 1	PHC1 (terminals P1-PC) 1: ON 0: OFF
			Bit 2	PHC2 (terminals P2-PC) 1: ON 0: OFF
			Bit 3 to 5	Not used.
			Bit 6	Set error contact (terminal MA-MC) output using bit 7. 1: ON 0: OFF
			Bit 7	Error contact (terminal MA-MC) 1: ON 0: OFF
Bit 8 to 15	Not used.			

Class 64		Register number (hex)	Content	
Instance	Attribute			
---	---	000A to 000E	Not used.	
00	0F	000F	Reference selection settings	
			Bit 0	Not used.
			Bit 1	PID target value (register 0006H) 1: Enabled 0: Disabled
			Bit 2 to 15	Not used.

10-5-2 Inverter Monitoring Functions (Read)

Class 64		Register number (hex)	Content	
Instance	Attribute			
00	20	0020	Inverter status	
			Bit 0	Operation 1: Operating 0: Stopped
			Bit 1	Reverse operation 1: Reverse operation 0: Forward operation or stopped
			Bit 2	Inverter startup complete 1: Completed 0: Not completed
			Bit 3	Error 1: Error
			Bit 4	Data setting error 1: Error
			Bit 5	Multi-function contact output (terminals M1-M2) 1: ON 0: OFF
			Bit 6	Multi-function PHC output 1 (terminals P1-PC) 1: ON 0: OFF
			Bit 7	Multi-function PHC output 2 (terminals P2-PC) 1: ON 0: OFF
Bit 8 to 15	Not used.			
00	21	0021	Error details	
			Bit 0	Overcurrent (OC), ground fault (GF)
			Bit 1	Main circuit overvoltage (OV)
			Bit 2	Inverter overload (OL2)
			Bit 3	Inverter overheat (OH1, OH2)
			Bit 4	Injection brake transistor resistance overheat (rr, rH)
			Bit 5	Fuse blown (PUF)
			Bit 6	PID feedback reference lost (FbL)
			Bit 7	External error (EF, EFO)
			Bit 8	Hardware error (CPF)
			Bit 9	Motor overload (OL1) or overtorque 1 (OL3) detected
			Bit 10	PG broken wire detected (PGO), overspeed (OS), speed deviation (DEV)
			Bit 11	Main circuit undervoltage (UV) detected
			Bit 12	Main circuit undervoltage (UV1), control power supply error (UV2), inrush prevention circuit error (UV3)
			Bit 13	Missing output phase (LF)
Bit 14	RS-422A/485 communications error (CE)			
Bit 15	Operator disconnected (OPR)			

Class 64		Register number (hex)	Content	
Instance	Attribute			
00	22	0022	Data link status	
			Bit 0	Writing data
			Bit 1 to 2	Not used.
			Bit 3	Upper and lower limit errors
			Bit 4	Data integrity error
			Bit 5 to 15	Not used.
00	23	0023	Frequency reference	Monitors U1-01 (Unit set with o1-03.)
00	24	0024	Output frequency	Monitors U1-02 (Unit set with o1-03.)
00	25	0025	Output voltage reference	Monitors U1-06 (0.1-V units)
00	26	0026	Output current	Monitors U1-03 (0.1-A units)
00	27	0027	Output power	Monitors U1-08 (0.1-kW units)
00	28	0028	Torque reference	Monitors U1-09 (0.1 units, 100% = motor's rated torque) Note: Only enabled for vector control.
---	---	0029 to 002A	Not used.	
00	2B	002B	Sequence input status	
			Bit 0	Multi-function input terminal S1 1: ON 0: OFF
			Bit 1	Multi-function input terminal S2 1: ON 0: OFF
			Bit 2	Multi-function input terminal S3 1: ON 0: OFF
			Bit 3	Multi-function input terminal S4 1: ON 0: OFF
			Bit 4	Multi-function input terminal S5 1: ON 0: OFF
			Bit 5	Multi-function input terminal S6 1: ON 0: OFF
			Bit 6	Multi-function input terminal S7 1: ON 0: OFF
	Bit 7 to 15	Not used.		

Class 64		Register number (hex)	Content	
Instance	Attribute			
00	2C	002C	Inverter status	
			Bit 0	Operation 1: Operating
			Bit 1	Zero speed 1: Zero speed
			Bit 2	Frequency agreement 1: Agreement
			Bit 3	User-defined speed agreement 1: Agreement
			Bit 4	Frequency detection 1 1: Output frequency \leq L4-01
			Bit 5	Frequency detection 2 1: Output frequency \geq L4-01
			Bit 6	Inverter startup completed 1: Startup completed
			Bit 7	Low voltage detection 1: Detected
			Bit 8	Baseblock 1: Inverter output baseblock
			Bit 9	Frequency reference mode 1: Not communications 0: Communications
			Bit 10	Run command mode 1: Not communications 0: Communications
			Bit 11	Overtorque detection 1: Detected
			Bit 12	Frequency reference lost 1: Lost
			Bit 13	Retrying error 1: Retrying
Bit 14	Fault. (including RS-422A/485 communications time-out) 1: fault occurred			
Bit 15	Communications time-out 1: Timed out			
00	2D	002D	Multi-function output status	
			Bit 0	Multi-function contact output (terminals M1-M2) 1: ON 0: OFF
			Bit 1	Multi-function PHC output 1 (terminals P1-PC): 1: ON 0: OFF
			Bit 2	Multi-function PHC output 2 (terminals P2-PC): 1: ON 0: OFF
			Bit 3 to 15	Not used.
---	---	002E to 0030	Not used.	
00	31	0031	Main circuit DC voltage	Monitors U1-07 (1-V units)
---	---	0032 to 0037	Not used.	
00	38	0038	PID feedback quantity	1% = 10; 100% = Input corresponding to max. output frequency; without sign
00	39	0039	PID input quantity	1% = 10; 100% = Max. output frequency; without sign
00	3A	003A	PID output quantity	1% = 10; 100% = Max. output frequency; without sign
00	3B	003B	CPU software number	
00	3C	003C	Flash software number	

Class 64		Register number (hex)	Content	
Instance	Attribute			
00	3D	003D	Communications error details	
			Bit 0	CRC error
			Bit 1	Invalid data length
			Bit 2	Not used.
			Bit 3	Parity error
			Bit 4	Overrun error
			Bit 5	Framing error
			Bit 6	Time-out
	Bit 7 to 15	Not used.		
00	3E	003E	kVA setting	
00	3F	003F	Control method	
00	40	0040	Frequency reference	Monitors U1-01; 0.01-Hz units (units set in o1-03; with sign)
00	41	0041	Output frequency	Monitors U1-02; 0.01-Hz units (units set in o1-03; with sign)
00	42	0042	Output current	Monitors U1-03; Percentage units: 8192 at rated output current
00	43	0043	Control method	Monitors U1-04; set in A1-02
00	44	0044	Motor speed	Monitors U1-05; 0.01-Hz units (units set in o1-03; with sign)
00	45	0045	Output voltage	Monitors U1-06; 0.1-V units
00	46	0046	Main circuit DC voltage	Monitors U1-07; 1-V units
00	47	0047	Output power	Monitors U1-08; 0.1-kW units (with sign)
00	48	0048	Torque reference	Monitors U1-09; 0.1%-kW units (100% = motor's rated torque; with sign)
00	49	0049	Input terminal status	Monitors U1-10; 1: ON. Bits 0 to 6 correspond to terminals S1 to S7.
00	4A	004A	Output terminal status	Monitors U1-11
			Bit 0	Terminals M1 and M2; 1: ON
			Bit 1	Terminals P1 and PC; 1: ON
			Bit 2	Terminals P2 and PC; 1: ON
			Bit 3 to 6	Not used.
			Bit 7	Terminals MA and MC; 1: ON
	Bit 8 to 15	Not used.		

Class 64		Register number (hex)	Content		
Instance	Attribute				
00	4B	004B	Operating status	Monitors U1-12	
				Bit 0	Operation 1: Operating
				Bit 1	Zero speed 1: Zero speed
				Bit 2	Reverse operation 1: Reverse operation
				Bit 3	during fault reset input
				Bit 4	Frequency agree
				Bit 5	Operation ready
				Bit 6	Alarm (Minor fault)
				Bit 7	Fault
Bit 8 to 15	Not used.				
00	4C	004C	Cumulative operation time	Monitors U1-13; 1-hr units	
00	4D	004D	FLASH ID software No.	Monitors U1-14	
00	4E	004E	Frequency reference (voltage): Terminal A1 input value	Monitors U1-15; 0.1% units (100% = 10 V; with sign for ± voltage setting)	
00	4F	004F	Multi-function analog input: Terminal A2 input value	Monitors U1-16; 0.1% units (100% = 10 V; with sign for ± voltage setting)	
00	51	0051	Motor secondary current	Monitors U1-18; 0.1% units (motor's rated secondary current = 100%; with sign)	
00	52	0052	Motor excitation current	Monitors U1-19; 0.1% units (motor's rated secondary current = 100%; with sign)	
00	53	0053	Output frequency after a soft start	Monitors U1-20; 0.01-Hz units (with sign)	
00	54	0054	Input to speed control loop	Monitors U1-21; 0.01% (max. frequency = 100%; with sign)	
00	55	0055	Output from speed control loop	Monitors U1-22; 0.01% units (motor's rated secondary current = 100%; with sign)	
00	57	0057	PID feedback	Monitors U1-24; 0.01% units (input corresponding to max. frequency = 100%; with sign)	
00	59	0059	Voltage reference for secondary current	Monitors U1-26; 0.1-V units (200 (400) VAC = 100%; with sign)	
00	5A	005A	Voltage reference for excitation current	Monitors U1-27; 0.1-V units (200 (400) VAC = 100%; with sign)	
00	5B	005B	CPU ID	Monitors U1-28	
00	5F	005F	q-axis ACR output	Monitors U1-32; 0.1% units (motor's rated secondary current = 100%; with sign)	
00	60	0060	d-axis ACR output	Monitors U1-33; 0.1% units (motor's rated secondary current = 100%; with sign)	

Class 64		Register number (hex)	Content						
Instance	Attribute								
00	61	0061	OPE error parameter	Monitors U1-34; outputs parameter					
00	63	0063	PID input quantity	Monitors U1-36; 0.01% units (max. frequency = 100%; with sign)					
00	64	0064	PID output quantity	Monitors U1-37; 0.01% units (max. frequency = 100%; with sign)					
00	65	0065	PID reference	Monitors U1-38; 0.01% units (max. frequency = 100%)					
00	66	0066	RS-422A/485 communications error	Monitors U1-39					
				Bit 0	CRC error				
				Bit 1	Invalid data length				
				Bit 2	Not used.				
				Bit 3	Parity error				
				Bit 4	Overrun error				
				Bit 5	Framing error				
				Bit 6	Time-out				
00	68	0068	Fan operating time	Monitors U1-40; 1-hr units					
00	80	0080	Current fault	Monitors U2-01					
				Code	Error display	Code	Error display	Code	Error display
				01	PUF	0E	OL4	1C	LF
				02	UV1	0F	RR	1D	OH3
				03	UV2	10	RH	1E	OPR
				04	UV3	11	EF3	1F	ERR
				06	GF	12	EF4	20	OH4
				07	OC	13	EF5	22	BUS
				08	OV	14	EF6	25	CF
				09	OH	15	EF7	27	EF0
				0A	OH1	18	OS	28	FBL
				0B	OL1	19	DEV	29	UL3
				0C	OL2	1A	PGO	2A	UL4
0D	OL3	1B	PF	2B	OL7				
00	81	0081	Last fault	Monitors U2-02 (same codes as U2-01)					
00	82	0082	Fault frequency reference	Monitors U2-03; 0.01-Hz units (units set in o1-03; with sign)					
00	83	0083	Fault output reference	Monitors U2-04; 0.01-Hz units (units set in o1-03; with sign)					
00	84	0084	Fault output current	Monitors U2-05; 0.1-A units					
00	85	0085	Fault motor speed	Monitors U2-06; 0.01-Hz units (units set in o1-03; with sign)					

Class 64		Register number (hex)	Content	
Instance	Attribute			
00	86	0086	Fault output voltage reference	Monitors U2-07; 0.1-V units
00	87	0087	Fault main circuit DC voltage	Monitors U2-08; 1-V units
00	88	0088	Fault output power	Monitors U2-09; 0.1-kW units (with sign)
00	89	0089	Fault torque reference	Monitors U2-10; 0.1% units (100% = motor's rated torque; with sign)
00	8A	008A	Fault input terminal status	Monitors U2-11 (same contents as U1-10)
00	8B	008B	Fault output terminal status	Monitors U2-12 (same contents as U1-11)
00	8C	008C	Fault operating status	Monitors U2-13 (same contents as U1-12)
00	8D	008D	Fault cumulative operation time	Monitors U2-14; 1-hr units
00 (08)	90 (00)	0090 (0800)	Content of last fault	Monitors U3-01 (same codes as U2-01)
00 (08)	91 (01)	0091 (0801)	Content of 2nd prior fault	Monitors U3-02 (same codes as U2-01)
00 (08)	92 (02)	0092 (0802)	Content of 3rd prior fault	Monitors U3-03 (same codes as U2-01)
00 (08)	93 (03)	0093 (0803)	Content of 4th prior fault	Monitors U3-04 (same codes as U2-01)
00 (08)	94 (0A)	0094 (080A)	Cumulative operation time since last fault	Monitors U3-05; 1-hr units
00 (08)	95 (0B)	0095 (080B)	Cumulative operation time since 2nd prior fault	Monitors U3-06; 1-hr units
00 (08)	96 (0C)	0096 (080C)	Cumulative operation time since 3rd prior fault	Monitors U3-07; 1-hr units
00 (08)	97 (0D)	0097 (080D)	Cumulative operation time since 4th prior fault	Monitors U3-08; 1-hr units
08	04	0804	Connect of 5th prior fault	Monitors U3-09 (same codes as U2-01) (See note.)
08	05	0805	Connect of 6th prior fault	Monitors U3-10 (same codes as U2-01) (See note.)
08	06	0806	Connect of 7th prior fault	Monitors U3-11 (same codes as U2-01) (See note.)
08	07	0807	Connect of 8th prior fault	Monitors U3-12 (same codes as U2-01) (See note.)

Class 64		Register number (hex)	Content	
Instance	Attribute			
08	08	0808	Connect of 9th prior fault	Monitors U3-13 (same codes as U2-01) (See note.)
08	09	0809	Connect of 10th prior fault	Monitors U3-14 (same codes as U2-01) (See note.)
08	0E	080E	Cumulative operation time since 5th prior fault	Monitors U3-15; 1-hr units (See note.)
08	0F	080F	Cumulative operation time since 6th prior fault	Monitors U3-16; 1-hr units (See note.)
08	10	0810	Cumulative operation time since 7th prior fault	Monitors U3-17; 1-hr units (See note.)
08	11	0811	Cumulative operation time since 8th prior fault	Monitors U3-18; 1-hr units (See note.)
08	12	0812	Cumulative operation time since 9th prior fault	Monitors U3-19; 1-hr units (See note.)
08	13	0813	Cumulative operation time since 10th prior fault	Monitors U3-20; 1-hr units (See note.)

Note U3-09 to U3-20 are not supported for Asian models. Register No. 0800 Hex to 0813 Hex are not supported for Asian models.

10-5-3 Parameter Reading and Writing

The following tables show the SYSDRIVE 3G3RV Inverter parameters and the corresponding register numbers. Write and read the various parameters with "1" as the minimum setting unit. Negative numbers are expressed as two's complement. If the setting unit is in hexadecimal, there is no need to convert it.

When writing data in parameters, be sure to send an enter command to enable the written data. Unless the enter command is transmitted, the data will not be enabled and the Inverter may not start.

■ Parameters for Initialize Mode

Con-stant	Regis-ter num-ber (hex)	Class 64 (hex)		Name	Setting range	Setting unit	Default setting	Write during operation
		In-stance	At-tribute					
A1-00	0100	01	00	Language selection for Digital Operator display	0 to 6	1	1	Yes
A1-01	0101	01	01	Parameter access level	0 to 2	1	2	Yes
A1-02	0102	01	02	Control method selection	0 to 2	1	0	No
A1-03	0103	01	03	Initialize	0 to 3330	1	0	No
A1-04	0104	01	04	Password	0 to 9999	1	0	No
A1-05	0105	01	05	Password setting	0 to 9999	1	0	No
A2-01 to A2-32	0106 to 0125	01	06 to 25	User-parameter settings	0180 to 050C Set the register numbers for b1-01 to o2-11.	1	---	No

■ Application Parameters

Con-stant	Regis-ter num-ber (hex)	Class 64 (hex)		Name	Setting range	Setting unit	Default setting	Write during operation
		In-stance	At-tribute					
b1-01	0180	01	80	Reference selection	0 to 4	1	1	No
b1-02	0181	01	81	Operation method selection	0 to 3	1	1	No
b1-03	0182	01	82	Stopping method selection	0 to 3	1	0	No
b1-04	0183	01	83	Prohibition of reverse operation	0 to 2 (See note 6.)	1	0	No
b1-06	0185	01	85	Read sequence input twice	0, 1	1	1	No
b1-07	0186	01	86	Operation selection after switching to remote mode	0, 1	1	0	No
b1-08	0187	01	87	Run command selection in programming modes	0, 1	1	0	No
b2-01	0189	01	89	Zero speed level (DC injection braking starting frequency)	0.0 to 10.0	0.1 Hz	0.5	No
b2-02	018A	01	8A	DC injection braking current	0 to 100	1%	50	No
b2-03	018B	01	8B	DC injection braking time at start	0.00 to 10.00	0.01 s	0.00	No
b2-04	018C	01	8C	DC Injection braking time at stop	0.00 to 10.00	0.01 s	0.50	No
b3-01	0191	01	91	Speed search selection (current detection or speed calculation)	0 to 3	1	2 (See note 1.)	No
b3-02	0192	01	92	Speed search operating current (current detection)	0 to 200	1%	120 (See note 1.)	No
b3-03	0193	01	93	Speed search deceleration time (current detection)	0.0 to 10.0	0.1 s	2.0	No
b3-05	0195	01	95	Speed search wait time (current detection or speed calculation)	0.0 to 20.0	0.1 s	0.2	No
b4-01	01A3	01	A3	Timer function ON-delay time	0.0 to 3000.0 (See note 5.)	0.1 s	0.0	No

Constant	Register number (hex)	Class 64 (hex)		Name	Setting range	Setting unit	Default setting	Write during operation
		Instance	Attribute					
b4-02	01A4	01	A4	Timer function OFF-delay time	0.0 to 3000.0 (See note 5.)	0.1 s	0.0	No
b5-01	01A5	01	A5	PID control mode selection	0 to 4	1	0	No
b5-02	01A6	01	A6	Proportional gain (P)	0.00 to 25.00	0.01	1.00	Yes
b5-03	01A7	01	A7	Integral (I) time	0.0 to 360.0	0.1 s	1.0	Yes
b5-04	01A8	01	A8	Integral (I) limit	0.0 to 100.0	0.1%	100.0	Yes
b5-05	01A9	01	A9	Derivative (D) time	0.00 to 10.00	0.01 s	0.00	Yes
b5-06	01AA	01	AA	PID limit	0.0 to 100.0	0.1%	100.0	Yes
b5-07	01AB	01	AB	PID offset adjustment	-100.0 to 100.0	0.1%	0.0	Yes
b5-08	01AC	01	AC	PID primary delay time constant	0.00 to 10.00	0.01 s	0.00	Yes
b5-09	01AD	01	AD	PID output characteristics selection	0, 1	1	0	No
b5-10	01AE	01	AE	PID output gain	0.0 to 25.0	0.1	1.0	No
b5-11	01AF	01	AF	PID reverse output selection	0, 1	1	0	No
b5-12	01B0	01	B0	Selection of PID feedback command loss detection	0 to 2	1	0	No
b5-13	01B1	01	B1	PID feedback command loss detection level	0 to 100	1%	0	No
b5-14	01B2	01	B2	PID feedback command loss detection time	0.0 to 25.5	0.1 s	1.0	No
b5-15	01B3	01	B3	PID sleep function operation level	0.0 to 400.0	0.1 Hz	0.0	No
b5-16	01B4	01	B4	PID sleep operation delay time	0.0 to 25.5	0.1 s	0.0	No
b5-17	01B5	01	B5	Accel/decel time for PID reference	0.0 to 25.5	0.1 s	0.0	No
b6-01	01B6	01	B6	Dwell frequency at start	0.0 to 400.0	0.1 Hz	0.0	No
b6-02	01B7	01	B7	Dwell time at start	0.0 to 10.0	0.1 s	0.0	No
b6-03	01B8	01	B8	Dwell frequency at stop	0.0 to 400.0	0.1 Hz	0.0	No
b6-04	01B9	01	B9	Dwell time at stop	0.0 to 10.0	0.1 s	0.0	No
b8-01	01CC	01	CC	Energy-saving mode selection	0, 1	1	0	No
b8-02	01CD	01	CD	Energy-saving gain	0.0 to 10.0	0.1	0.7 (See note 2.)	Yes
b8-03	01CE	01	CE	Energy-saving filter time constant	0.0 to 10.0	0.01 s	0.50 (See note 3.)	Yes
b8-04	01CF	01	CF	Energy-saving coefficient	0.00 to 655.00 (See note 4.)	0.01	Depends on capacity.	No
b8-05	01D0	01	D0	Power detection filter time constant	0 to 2000	1 ms	20	No
b8-06	01D1	01	D1	Search operation voltage limiter	0 to 100	1%	0	No

- Note 1.** When the control mode is changed, the Inverter will revert to default settings. (The V/F control default setting is given above.)
- Note 2.** The default setting is 0.1 for V/f control with PG.
- Note 3.** The default setting is 2.00 s for Inverters with a capacity of 55 kW or more.
- Note 4.** The same capacity as the Inverter can be set by initializing this parameter.
- Note 5.** The setting range for Asian models is 0 to 300.0
- Note 6.** The setting range for Asian models is 0 to 1.

■ Tuning Parameters

Constant	Register number (hex)	Class 64 (hex)		Name	Setting range	Setting unit	Default setting	Write during operation
		Instance	Attribute					
C1-01	0200	02	00	Acceleration time 1	0.0 to 6000.0 (Set with C1-10.)	0.1 s (Set with C1-10.)	10.0	Yes
C1-02	0201	02	01	Deceleration time 1				Yes
C1-03	0202	02	02	Acceleration time 2				Yes
C1-04	0203	02	03	Deceleration time 2				Yes
C1-05	0204	02	04	Acceleration time 3				No
C1-06	0205	02	05	Deceleration time 3				No
C1-07	0206	02	06	Acceleration time 4				No
C1-08	0207	02	07	Deceleration time 4				No
C1-09	0208	02	08	Deceleration Stop Time				No
C1-10	0209	02	09	Accel/decel time setting unit				0, 1
C1-11	020A	02	0A	Accel/decel time switching frequency	0.0 to 400.0	0.1 Hz	0.0	No
C2-01	020B	02	0B	S-curve characteristic time at acceleration start	0.00 to 2.50	0.01 s	0.20	No
C2-02	020C	02	0C	S-curve characteristic time at acceleration end	0.00 to 2.50	0.01 s	0.20	No
C2-03	020D	02	0D	S-curve characteristic time at deceleration start	0.00 to 2.50	0.01 s	0.20	No
C2-04	020E	02	0E	S-curve characteristic time at deceleration end	0.00 to 2.50	0.01 s	0.00	No
C3-01	020F	02	0F	Slip compensation gain	0.0 to 2.5	0.1	0.0 (See note 1.)	Yes
C3-02	0210	02	10	Slip compensation primary delay time	0 to 10000	1 ms	2000 (See note 1.)	No
C3-03	0211	02	11	Slip compensation limit	0 to 250	1%	200	No
C3-04	0212	02	12	Slip compensation selection during regeneration	0, 1	1	0	No
C3-05	0213	02	13	Output voltage limit operation selection	0, 1	1	0	No
C4-01	0215	02	15	Torque compensation gain	0.00 to 2.50	0.01	1.00	Yes
C4-02	0216	02	16	Torque compensation primary delay time constant	0 to 10000	1 ms	200 (See note 1.)	No
C4-03	0217	02	17	Starting torque value (forward) (See note 4.)	0.0 to 200.0	0.1%	0.0	No
C4-04	0218	02	18	Starting torque value (reverse) (See note 4.)	-200.0 to 0.0	0.1%	0.0	No
C4-05	0219	02	19	Starting torque time constant (See note 4.)	0 to 200	1 ms	10	No

Con-stant	Regis-ter num-ber (hex)	Class 64 (hex)		Name	Setting range	Setting unit	Default setting	Write during operation
		In-stance	At-tribute					
C5-01	021B	02	1B	ASR proportional (P) gain 1	0.00 to 300.00	0.01	0.20	Yes
C5-02	021C	02	1C	ASR integral (I) time 1	0.000 to 10.000	0.001 s	0.200	Yes
C5-03	021D	02	1D	ASR proportional (P) gain 2	0.00 to 300.00	0.01	0.02	Yes
C5-04	021E	02	1E	ASR integral (I) time 2	0.000 to 10.000	0.001 s	0.050	Yes
C5-05	021F	02	1F	ASR limit	0.0 to 20.0	0.1%	5.0	No
C6-01	0223	02	23	CT/VT selection	0, 1	1	1	No
C6-02	0224	02	24	Carrier frequency selection	0 to F	1	Depends on capacity.	No
C6-03	0225	02	25	Carrier frequency upper limit	2.0 to 15.0 (See note 2 and 3.)	0.1 kHz	Depends on capacity.	No
C6-04	0226	02	26	Carrier frequency lower limit	0.4 to 15.0 (See note 2 and 3.)	0.1 kHz	Depends on capacity.	No
C6-05	0227	02	27	Carrier frequency proportional gain	00 to 99 (See note 3.)	1	00	No

Note 1. When the control mode is changed, the Inverter will revert to default settings. (The V/f control default setting is given above.)

Note 2. The setting range depends on the capacity of the Inverter.

Note 3. These parameters can be monitored or set only when 1 is set for C6-01 and F is set for C6-02.

■ Reference Parameters

Constant	Register number (hex)	Class 64 (hex)		Name	Setting range	Setting unit	Default setting	Write during operation
		Instance	Attribute					
d1-01	0280	02	80	Frequency reference 1	0 to max. output frequency (See note.)	0.01 Hz (Set with 01-03.)	0.00	Yes
d1-02	0281	02	81	Frequency reference 2			0.00	Yes
d1-03	0282	02	82	Frequency reference 3			0.00	Yes
d1-04	0283	02	83	Frequency reference 4			0.00	Yes
d1-05	0284	02	84	Frequency reference 5			0.00	Yes
d1-06	0285	02	85	Frequency reference 6			0.00	Yes
d1-07	0286	02	86	Frequency reference 7			0.00	Yes
d1-08	0287	02	87	Frequency reference 8			0.00	Yes
d1-09	0288	02	88	Frequency reference 9			0.00	Yes
d1-10	028B	02	8B	Frequency reference 10			0.00	Yes
d1-11	028C	02	8C	Frequency reference 11			0.00	Yes
d1-12	028D	02	8D	Frequency reference 12			0.00	Yes
d1-13	028E	02	8E	Frequency reference 13			0.00	Yes
d1-14	028F	02	8F	Frequency reference 14			0.00	Yes
d1-15	0290	02	90	Frequency reference 15			0.00	Yes
d1-16	0291	02	91	Frequency reference 16			0.00	Yes
d1-17	0292	02	92	Jog frequency reference			6.00	Yes
d2-01	0289	02	89	Frequency reference upper limit	0.0 to 110.0	0.1%	100.0	No
d2-02	028A	02	8A	Frequency reference lower limit	0.0 to 110.0	0.1%	0.0	No
d2-03	0293	02	93	Master speed reference lower limit	0.0 to 110.0	0.1%	0.0	No
d3-01	0294	02	94	Jump frequency 1	0.0 to 400.0	0.1 Hz	0.0	No
d3-02	0295	02	95	Jump frequency 2		0.1 Hz	0.0	No
d3-03	0296	02	96	Jump frequency 3		0.1 Hz	0.0	No
d3-04	0297	02	97	Jump frequency width	0.0 to 20.0	0.1 Hz	1.0	No
d4-01	0298	02	98	Frequency reference hold function selection	0, 1	1	0	No
d4-02	0299	02	99	+ – Speed limits	0 to 100	1%	10	No
d6-01	02A0	02	A0	Field weakening level	0 to 100	1%	80	No
d6-02	02A1	02	A1	Field frequency	0.0 to 400.0	0.1 Hz	0.0	No

Note Values exceeding the max. output frequency (E1-04 and E3-02) cannot be set. Set the motor constant parameters first.

■ Motor Constant Parameters

Constant	Register number (hex)	Class 64 (hex)		Name	Setting range	Setting unit	Default setting	Write during operation
		Instance	Attribute					
E1-01	0300	03	00	Input voltage setting	155 to 255 (155 to 510) (See note 1.)	1 V	200 (400) (See note 1.)	No
E1-03	0302	03	02	V/f pattern selection	0 to F	1	F	No
E1-04	0303	03	03	Max. output frequency	40.0 to 400.0 (See note 5.)	0.1 Hz	50.0 (60.0) (See notes 3 and 8.)	No
E1-05	0304	03	04	Max. voltage	0.0 to 255.0 (0.0 to 510.0) (See note 1.)	0.1 V	200.0 (400.0) (See note 1.)	No
E1-06	0305	03	05	Base frequency	0.0 to 400.0	0.1 Hz	50.0 (60.0) (See notes 3 and 8.)	No
E1-07	0306	03	06	Mid. output frequency	0.0 to 400.0	0.1 Hz	3.0 (See note 3.)	No
E1-08	0307	03	07	Mid. output frequency voltage	0.0 to 255.0 (0.0 to 510.0) (See note 1.)	0.1 V	15.0 (30.0) (See notes 1 and 3.)	No
E1-09	0308	03	08	Min. output frequency	0.0 to 400.0	0.1 Hz	1.5 (See note 3.)	No
E1-10	0309	03	09	Min. output frequency voltage	0.0 to 255.0 (0.0 to 510.0) (See note 1.)	0.1 V	9.0 (18.0) (See notes 1 and 3.)	No
E1-11	030A	03	0A	Mid. output frequency 2	0.0 to 400.0	0.1 Hz	0.0 (See note 6.)	No
E1-12	030B	03	0B	Mid. output frequency voltage 2	0.0 to 255.0 (0.0 to 510.0) (See note 1.)	0.1 V	0.0 (See note 6.)	No
E1-13	030C	03	0C	Base voltage	0.0 to 255.0 (0.0 to 510.0) (See note 1.)	0.1 V	0.0 (See note 4.)	No
E2-01	030E	03	0E	Motor rated current	0.32 to 6.40 (See note 2.)	0.01 A	Depends on capacity.	No
E2-02	030F	03	0F	Motor rated slip	0.00 to 20.00	0.01 Hz	Depends on capacity.	No

Con-stant	Regis-ter num-ber (hex)	Class 64 (hex)		Name	Setting range	Setting unit	Default setting	Write during operation
		In-stance	At-tribute					
E2-03	0310	03	10	Motor no-load current	Depends on capacity.	0.01 A	Depends on capacity.	No
E2-04	0311	03	11	Number of motor poles	2 to 48	1 pole	4	No
E2-05	0312	03	12	Motor line-to-line resistance	0.000 to 65.000	0.001 Ω	Depends on capacity.	No
E2-06	0313	03	13	Motor leak inductance	0.0 to 40.0	0.1%	Depends on capacity.	No
E2-07	0314	03	14	Motor iron saturation coefficient 1	0.00 to 0.50	0.01	0.50	No
E2-08	0315	03	15	Motor iron saturation coefficient 2	0.00 to 0.75	0.01	0.75	No
E2-10	0317	03	17	Motor iron loss for torque compensation	0 to 65535	1 W	Depends on capacity.	No
E2-11	0318	03	18	Motor rated output	0.00 to 650.00	0.01 kW	Depends on capacity.	No
E3-01	0319	03	19	Motor 2 control method selection	0 to 2	1	0	No
E3-02	031A	03	1A	Motor 2 max. output frequency (FMAX)	40.0 to 400.0 (See note 5.)	0.1 Hz	60.0	No
E3-03	031B	03	1B	Motor 2 max. voltage (VMAX)	0.0 to 255.0 (0.0 to 510.0)	0.1 V	200.0 (400.0) (See notes 1 and 3.)	No
E3-04	031C	03	1C	Motor 2 max. voltage frequency (FA)	0.0 to 400.0	0.1 Hz	60.0	No
E3-05	031D	03	1D	Motor 2 mid. output frequency (FB)	0.0 to 400.0	0.1 Hz	3.0 (See notes 1 and 3.)	No
E3-06	031E	03	1E	Motor 2 mid. output frequency voltage 1 (VC)	0.0 to 255.0 (0.0 to 510.0)	0.1 V	11.0 (22.0)	No
E3-07	031F	03	1F	Motor 2 min. output frequency (FMIN)	0.0 to 400.0	0.1 Hz	1.5 (See note 3.)	No
E3-08	0320	03	20	Motor 2 min. output frequency voltage (VMIN)	0.0 to 255.0 (0.0 to 510.0)	0.1 V	9.0 (18.0) (See notes 1 and 3.)	No
E4-01	0321	03	21	Motor 2 rated current	0.32 to 6.40 (See note 2.)	0.01 A	Depends on capacity.	No
E4-02	0322	03	22	Motor 2 rated slip	0.00 to 20.00	0.01 Hz	Depends on capacity.	No

Constant	Register number (hex)	Class 64 (hex)		Name	Setting range	Setting unit	Default setting	Write during operation
		Instance	Attribute					
E4-03	0323	03	23	Motor 2 no-load current	0.00 to 1.89 (See note 7.)	0.01 A	Depends on capacity.	No
E4-04	0324	03	24	Motor 2 number of poles (number of poles)	2 to 48	1 pole	4	No
E4-05	0325	03	25	Motor 2 line-to-line resistance	0.000 to 65.000	0.01 Ω	Depends on capacity.	No
E4-06	0326	03	26	Motor 2 leak inductance	0.0 to 40.0	0.1%	Depends on capacity.	No
E4-07	0327	03	27	Motor 2 rated capacity	0.40 to 650.00	0.01 kW	Depends on capacity.	No

- Note 1.** Values in parentheses are for 400-V-class Inverters.
- Note 2.** The setting range is 10% to 200% of the Inverter's rated output current. The values for a 200-V-class 0.4-kW Inverter are given above.
- Note 3.** When the control mode is changed, the Inverter will revert to default settings. (The V/f control default settings are given above.)
- Note 4.** E1-13 will be the same value as E1-05 after autotuning.
- Note 5.** The upper setting limit will be 150.0 Hz when C6-01 is set to 0.
- Note 6.** The settings of E1-11 and E1-12 are ignored if set to 0.0.
- Note 7.** If multi-function input H1-□□ is set to 16 (motor 2), the default setting will depend upon the Inverter capacity. The value for a 200-V-class 0.4-kW Inverter is given.
- Note 8.** Values in parentheses are for Asian model Inverters.

■ Option Parameters

Constant	Register number (hex)	Class 64 (hex)		Name	Setting range	Setting unit	Default setting	Write during operation
		Instance	Attribute					
F1-01	0380	03	80	PG constant	0 to 60000	1	1024 (600) (See note.)	No
F1-02	0381	03	81	Operation selection at PG open circuit (PGO)	0 to 3	1	1	No
F1-03	0382	03	82	Operation selection at overspeed (OS)	0 to 3	1	1	No
F1-04	0383	03	83	Operation selection at deviation	0 to 3	1	3	No
F1-05	0384	03	84	PG rotation	0, 1	1	0	No
F1-06	0385	03	85	PG division rate (PG pulse monitor)	0 to 132	1	1	No
F1-07	0386	03	86	Integral value during accel/decel enable/disable	0, 1	1	0	No
F1-08	0387	03	87	Overspeed detection level	0 to 120	1%	115	No
F1-09	0388	03	88	Overspeed detection delay time	0.0 to 2.0	0.1 s	1.0	No
F1-10	0389	03	89	Excessive speed deviation detection level	0 to 50	1%	10	No
F1-11	038A	03	8A	Excessive speed deviation detection delay time	0.0 to 10.0	0.1 s	0.5	No

Constant	Register number (hex)	Class 64 (hex)		Name	Setting range	Setting unit	Default setting	Write during operation
		Instance	Attribute					
F1-12	038B	03	8B	Number of PG gear teeth 1	0 to 1000	1	0	No
F1-13	038C	03	8C	Number of PG gear teeth 2	0 to 1000	1	0	No
F1-14	038D	03	8D	PG open-circuit detection time	0.0 to 10.0	0.1 s	2.0	No
F4-01	0391	03	91	Channel 1 monitor selection	1 to 40	1	2	No
F4-02	0392	03	92	Channel 1 gain	0.00 to 2.50	0.01	1.00	Yes
F4-03	0393	03	93	Channel 2 monitor selection	1 to 40	1	3	No
F4-04	0394	03	94	Channel 2 gain	0.00 to 2.50	0.01	0.50	Yes
F4-05	0395	03	95	Channel 1 output monitor bias	-10.0 to 10.0	0.1	0.0	Yes
F4-06	0396	03	96	Channel 2 output monitor bias	-10.0 to 10.0	0.1	0.0	Yes
F4-07	0397	03	97	Analog output signal level for channel 1	0, 1	1	0	No
F4-08	0398	03	98	Analog output signal level for channel 2	0, 1	1	0	No
F5-01	0399	03	99	Not used.	---	---	0	No
F5-02	039A	03	9A	Not used.	---	---	1	No
F5-03	039B	03	9B	Not used.	---	---	2	No
F5-04	039C	03	9C	Not used.	---	---	4	No
F5-05	039D	03	9D	Not used.	---	---	6	No
F5-06	039E	03	9E	Not used.	---	---	37	No
F5-07	039F	03	9F	Not used.	---	---	0F	No
F5-08	03A0	03	A0	Not used.	---	---	0F	No
F5-09	03A1	03	A1	Not used.	---	---	0	No
F6-01	03A2	03	A2	DeviceNet fault operation selection	0 to 3	1	1	No
F6-02	03A3	03	A3	Communications external fault input detection method selection	0, 1	1	0	No
F6-03	03A4	03	A4	Communications external fault input operation selection	0 to 3	1	1	No
F6-04	03A5	03	A5	Not used.	---	---	0	No

Note Values in parentheses are Asian model Inverters

External Terminal Function Parameters

Constant	Register number (hex)	Class 64 (hex)		Name	Setting range	Setting unit	Default setting	Write during operation
		Instance	Attribute					
H1-01	0400	04	00	Terminal S3 function selection	0 to 68	1	24	No
H1-02	0401	04	01	Terminal S4 function selection	0 to 68	1	14	No
H1-03	0402	04	02	Terminal S5 function selection	0 to 68	1	3 (0) (See note 1.)	No
H1-04	0403	04	03	Terminal S6 function selection	0 to 68	1	4 (3) (See note 1.)	No
H1-05	0404	04	04	Terminal S7 function selection	0 to 68	1	6 (4) (See note 1.)	No
H2-01	040B	04	0B	Terminal M1-M2 Select	0 to 37	1	0	No

Constant	Register number (hex)	Class 64 (hex)		Name	Setting range	Setting unit	Default setting	Write during operation
		Instance	Attribute					
H2-02	040C	04	0C	Terminal P1 function select (open collector)	0 to 37	1	1	No
H2-03	040D	04	0D	Terminal P2 function select (open collector)	0 to 37	1	2	No
H3-01	0410	04	10	Signal select terminal A1 (voltage) (See note 4.)	0 or 1	1	0	No
H3-02	0411	04	11	Frequency reference (voltage) gain (terminal A1)	0.0 to 1000.0	0.1%	100.0	Yes
H3-03	0412	04	12	Frequency reference (voltage) bias (terminal A1)	-100.0 to 100.0	0.1%	0.0	Yes
H3-08	0417	04	17	Multi-function analog input terminal A2 signal level selection	0 to 2	1	2	No
H3-09	0418	04	18	Multi-function analog input terminal A2 function selection	0 to 1F	1	0	No
H3-10	0419	04	19	Frequency reference (current) gain (terminal A2)	0.0 to 1000.0	0.1%	100.0	Yes
H3-11	041A	04	1A	Frequency reference (current) bias (terminal A2)	-100.0 to 100.0	0.1%	0.0	Yes
H3-12	041B	04	1B	Analog input filter time constant	0.00 to 2.00	0.01 s	0.00	No
H3-13	041C	04	1C	Terminal A1/A2 switching	0, 1	1	0	No
H4-01	041D	04	1D	Multi-function analog output 1 monitor selection (terminal FM)	1 to 40	1	2	No
H4-02	041E	04	1E	Multi-function analog output 1 gain (terminal FM)	0.0 to 1000.0 (0.00 to 2.50) (see note 3.)	0.1% (0.01) (See note 3.)	100.0 (1.00) (See note 3.)	Yes
H4-03	041F	04	1F	Multi-function analog output 1 bias (terminal FM)	-110.0 to 110.0 (-10.0 to 10.0) (See note 3.)	0.1%	0.0	Yes
H4-04	0420	04	20	Multi-function analog output 2 monitor selection (terminal AM)	1 to 40	1	3	No
H4-05	0421	04	21	Multi-function analog output 2 gain (terminal AM)	0.0 to 1000.0 (0.00 to 2.50)	0.1% (0.01) (See note 3.)	50 (0.50) (See note 3.)	Yes
H4-06	0422	04	22	Multi-function analog output 2 bias (terminal AM)	-110.0 to 110.0 (-10.0 to 10.0) (See note 3)	0.1%	0.0	Yes
H4-07	0423	04	23	Multi-function analog output 1 signal level selection	0, 1, 2 (0, 1) (See note 3.)	1	0	No
H4-08	0424	04	24	Multi-function analog output 2 signal level selection	0, 1	1	0	No
H5-01	0425	04	25	Slave address	0 to 20 (See note 2.)	1	1F	No
H5-02	0426	04	26	Communication speed selection	0 to 4	1	3	No
H5-03	0427	04	27	Communication parity selection	0 to 2	1	0	No

Con-stant	Regis-ter num-ber (hex)	Class 64 (hex)		Name	Setting range	Setting unit	Default setting	Write during operation
		In-stance	At-tribute					
H5-04	0428	04	28	Stopping method after communication error	0 to 3	1	3	No
H5-05	0429	04	29	Communication error detection selection	0, 1	1	1	No
H5-06	042A	04	2A	Send wait time	5 to 65	1 ms	5	No
H5-07	042B	04	2B	RTS control ON/OFF	0, 1	1	1	No
H6-01	042C	04	2C	Pulse train input function selection	0 to 2	1	0	No
H6-02	042D	04	2D	Pulse train input scaling	1000 to 32000	1 Hz	1440	Yes
H6-03	042E	04	2E	Pulse train input gain	0.0 to 1000.0	0.1%	100.0	Yes
H6-04	042F	04	2F	Pulse train input bias	-100.0 to 100.0	0.1%	0.0	Yes
H6-05	0430	04	30	Pulse train input filter time	0.00 to 2.00	0.01 s	0.10	Yes
H6-06	0431	04	31	Pulse train monitor selection	1, 2, 5, 20, 24, 36	1	2	Yes
H6-07	0432	04	32	Pulse train monitor scaling	0 to 32000	1 Hz	1440	Yes

Note 1. The values in parentheses indicate initial values when initialized in 3-wire sequence.

Note 2. Set H5-01 to 0 to disable Inverter responses to RS-422A/485 communications.

Note 3. Values in parentheses are for Asian model Inverters.

Note 4. This parameter is not supported by the Asian model Inverters.

■ Protective Function Parameters

Con-stant	Regis-ter num-ber (hex)	Class 64 (hex)		Name	Setting range	Setting unit	Default setting	Write during operation
		In-stance	At-tribute					
L1-01	0480	04	80	Motor protection selection	0 to 3	1	1	No
L1-02	0481	04	81	Motor protection time constant	0.1 to 5.0	0.1 min	1.0	No
L1-03	0482	04	82	Alarm operation selection during motor overheating	0 to 3	1	3	No
L1-04	0483	04	83	Motor overheating operation selection	0 to 2	1	1	No
L1-05	0484	04	84	Motor temperature input filter time constant	0.00 to 10.00	0.01 s	0.20	No
L2-01	0485	04	85	Momentary power loss detection	0 to 2	1	0	No
L2-02	0486	04	86	Momentary power loss ridethru time	0.0 to 2.0	0.1 s	Depends on capacity.	No
L2-03	0487	04	87	Min. baseblock time	0.1 to 5.0	0.1 s	Depends on capacity.	No
L2-04	0488	04	88	Voltage recovery time	0.0 to 5.0	0.1 s	Depends on capacity.	No
L2-05	0489	04	89	Undervoltage detection level	150 to 210 (150 to 420) (See note 1.)	1 V	190 (380) (See note 1.)	No

Constant	Register number (hex)	Class 64 (hex)		Name	Setting range	Setting unit	Default setting	Write during operation
		Instance	Attribute					
L2-06	048A	04	8A	KEB deceleration time	0.0 to 200.0	0.1 s	0.0	No
L2-07	048B	04	8B	Momentary recovery time	0.0 to 25.5	0.1 s	0.0 (See note 2.)	No
L2-08	048C	04	8C	Frequency reduction gain at KEB start	0 to 300	1	100	No
L3-01	048F	04	8F	Stall prevention selection during accel	0 to 2	1	1	No
L3-02	0490	04	90	Stall prevention level during accel	0 to 200	1%	120 (See note 3.)	No
L3-03	0491	04	91	Stall prevention limit during accel	0 to 100	1%	50	No
L3-04	0492	04	92	Stall prevention selection during decel	0 to 3	1	1	No
L3-05	0493	04	93	Stall prevention selection during running	0 to 2	1	1	No
L3-06	0494	04	94	Stall prevention level during running	30 to 200	1%	120 (See note 3.)	No
L4-01	0499	04	99	Speed agreement detection level	0.0 to 400.0	0.1 Hz	0.0	No
L4-02	049A	04	9A	Speed agreement detection width	0.0 to 20.0	0.1 Hz	2.0	No
L4-03	049B	04	9B	Speed agreement detection level (+/-)	-400.0 to 400.0	0.1 Hz	0.0	No
L4-04	049C	04	9C	Speed agreement detection width (+/-)	0.0 to 20.0	0.1 Hz	2.0	No
L4-05	049D	04	9D	Operation when frequency reference is lost	0, 1	1	0	No
L4-06	04C2	04	C2	Frequency reference for loss of frequency reference	0.0 to 100.0	0.1%	80.0	No
L5-01	049E	04	9E	Number of auto restart attempts	0 to 10	1	0	No
L5-02	049F	04	9F	Auto restart operation selection	0, 1	1	0	No
L6-01	04A1	04	A1	Torque detection selection 1	0 to 8	1	0	No
L6-02	04A2	04	A2	Torque detection level 1	0 to 300	1%	150	No
L6-03	04A3	04	A3	Torque detection time 1	0.0 to 10.0	0.1 s	0.1	No
L6-04	04A4	04	A4	Torque detection selection 2	0 to 8	1	0	No
L6-05	04A5	04	A5	Torque detection level 2	0 to 300	1%	150	No
L6-06	04A6	04	A6	Torque detection time 2	0.0 to 10.0	0.1 s	0.1	No
L7-01	04A7	04	A7	Forward drive torque limit	0 to 300	1%	200	No
L7-02	04A8	04	A8	Reverse drive torque limit	0 to 300	1%	200	No
L7-03	04A9	04	A9	Forward regenerative torque limit	0 to 300	1%	200	No
L7-04	04AA	04	AA	Reverse regenerative torque limit	0 to 300	1%	200	No
L8-01	04AD	04	AD	Protect selection for internal DB resistor	0, 1	1	0	No
L8-02	04AE	04	AE	Overheat pre-alarm level	50 to 130	1°C	Depends on capacity.	No
L8-03	04AF	04	AF	Operation selection after overheat pre-alarm	0 to 3	1	3	No
L8-05	04B1	04	B1	Input open-phase protection selection	0, 1	1	1 (0) (See note 4.)	No
L8-07	04B3	04	B3	Output open-phase protection selection	0, 1	1	0	No
L8-09	04B5	04	B5	Ground protection selection	0, 1	1	1	No

Con- stant	Regis- ter num- ber (hex)	Class 64 (hex)		Name	Setting range	Setting unit	Default setting	Write during opera- tion
		In- stance	At- tribute					
L8-10	04B6	04	B6	Cooling fan control selection	0, 1	1	0	No
L8-11	04B7	04	B7	Cooling fan control delay time	0 to 300	1 s	60	No
L8-12	04B8	04	B8	Ambient temperature	45 to 60	1°C	45	No
L8-15	04BB	04	BB	OL2 characteristics selection at low speeds	0, 1	1	1	No
L8-18	04BE	04	BE	Soft CLA selection	0, 1	1	1	No

Note 1. Values in parentheses are for 400-V-class Inverters.

Note 2. If the setting is 0, the axis will accelerate to the specified speed over the specified acceleration time (C1-01 to C1-08).

Note 3. The initial value when C6-01 is set to 1 is given. If C6-01 is set to 0, the initial value will be 150%.

Note 4. Values in parentheses are for Asian model Inverters.

■ Special Adjustment Parameters

Con- stant	Regis- ter num- ber (hex)	Class 64 (hex)		Name	Setting range	Setting unit	Default setting	Write during opera- tion
		In- stance	At- tribute					
N1-01	0580	05	80	Hunting-prevention function selection	0, 1	1	1	No
N1-02	0581	05	81	Hunting-prevention gain	0.00 to 2.50	0.01	1.00	No
N2-01	0584	05	84	Speed feedback detection control (AFR) gain	0.00 to 10.00	0.01	1.00	No
N2-02	0585	05	85	Speed feedback detection control (AFR) time constant	0 to 2000	1 ms	50	No
N2-03	0586	05	86	Speed feedback detection control (AFR) time constant 2	0 to 2000	1 ms	750	No
N3-01	0588	05	88	High-slip braking deceleration frequency width	1 to 20	1%	5	No
N3-02	0589	05	89	High-slip braking current limit	100 to 200	1%	150	No
N3-03	058A	05	8A	High-slip braking stop dwell time	0.1 to 10.0	0.1 s	1.0	No
N3-04	058B	05	8B	High-slip braking OL time	30 to 1200	1 s	40	No

■ Operator Parameters

Con- stant	Regis- ter num- ber (hex)	Class 64 (hex)		Name	Setting range	Setting unit	Default setting	Write during opera- tion
		In- stance	At- tribute					
o1-01	0500	05	00	Monitor selection	4 to 33	1	6	Yes
o1-02	0501	05	01	Monitor selection after power up	1 to 4	1	1	Yes
o1-03	0502	05	02	Frequency units of reference setting and monitor	0 to 39999	1	0	No
o1-05	0504	05	04	LCD brightness	0 to 5	1	3	Yes
o2-01	0505	05	05	LOCAL/REMOTE key enable/disable	0, 1	1	1	No
o2-02	0506	05	06	STOP key during control circuit terminal operation	0, 1	1	1	No

Constant	Register number (hex)	Class 64 (hex)		Name	Setting range	Setting unit	Default setting	Write during operation
		Instance	Attribute					
o2-03	0507	05	07	Parameter initial value	0 to 2	1	0	No
o2-04	0508	05	08	kVA selection	0 to FF	1	Depends on capacity.	No
o2-05	0509	05	09	Frequency reference setting method selection	0, 1	1	0	No
o2-06	050A	05	0A	Operation selection when digital operator is disconnected	0, 1	1	0	No
o2-07	050B	05	0B	Cumulative operation time setting	0 to 65535	1 hr	0	No
o2-08	050C	05	0C	Cumulative operation time selection	0, 1	1	1 (0) (See note 1.)	No
o2-09	050D	05	0D	Initialize mode Do not change.	---	---	---	No
o2-10	050E	05	0E	Fan operation time setting	0 to 65535	1 hr	0	No
o2-11	0510	05	10	Fault trace/fault history initialization (See note 2.)	0, 1	1	0	No

Note 1. Values in parentheses are for Asian model Inverters.

Note 2. Set T1-02 and T1-04 when T1-01 is set to 2. This setting (2) is only possible for V/f control or V/f control with PG.

■ Motor Autotuning Parameters

Constant	Register number (hex)	Class 64 (hex)		Name	Setting range	Setting unit	Default setting	Write during operation
		Instance	Attribute					
T1-00	0700	07	00	Motor 1/2 selection	1, 2	1	1	No
T1-01	0701	07	01	Autotuning mode selection	0 to 2 (See note 2.)	1	0	No
T1-02	0702	07	02	Motor output power	0.00 to 650.00	0.01 kW	0.40	No
T1-03	0703	07	03	Motor rated voltage	0.0 to 255.0 (0.0 to 510.0) (See note 1.)	0.1 V	200.0 (400.0) (See note 1.)	No
T1-04	0704	07	04	Motor rated current	0.32 to 6.40 (See note 3.)	0.01 A	Depends on capacity.	No
T1-05	0705	07	05	Motor base frequency	0.00 to 400.00 (See note 4.)	0.01 Hz	60.00	No
T1-06	0706	07	06	Number of motor poles	2 to 48	1	4	No
T1-07	0707	07	07	Motor base speed	0 to 24000	1 r/min	1750	No

Note 1. Values in parentheses are for 400-V-class Inverters.

Note 2. Set T1-02 and T1-04 when T1-01 is set to 2. This setting (2) is only possible for V/f control or V/f control with PG.

Note 3. The setting range is from 10% to 200% of the Inverter rated output current. (The value for a 200-V-class 0.4-kW Inverter is given.)

Note 4. The upper setting limit will be 150.0 Hz when C6-01 is set to 0.

10-6 3G3PV Register Numbers, Classes, Instances, and Attributes

10-6-1 Inputting Control/Frequency (Read/Write)

Class 64		Register No. (Hex)	Contents			
In-stance	At-tribute					
---	---	0000	Reserved			
00	01	0001	Frequency reference			
			Bit 0	Run/stop command 1: Run 0: Stop		
			Bit 1	Reverse/stop command 1: Reverse 0: Stop		
			Bit 2	Multi-function input command 3		
			Bit 3	Multi-function input command 4		
			Bit 4	Multi-function input command 5		
			Bit 5	Multi-function input command 6		
			Bit 6	Multi-function input command 7		
			Bit 7	Not used.		
			Bit 8	External error 1: Error (EFO)		
			Bit 9	Error reset 1: Reset command		
Bits 10 to 15		Not used.				
00	02	0002	Frequency reference (Set units using parameter o1-03.)			
---	---	0003 to 0005	Not used.			
00	06	0006	PID target value			
00	07	0007	Analog output 1 setting (-11 V/-726 Dec. to 11 V/726 Dec.)			
00	08	0008	Not used.			
00	09	0009	Multi-function contact output setting			
			Bit 0	Contact output (terminal M1-M2) 1: ON 0: OFF		
			Bit 1	Contact output (terminal M3-M4) 1: ON 0: OFF		
			Bits 2 to 5		Not used.	
			Bit 6	Set error contact (terminal MA-MC) output using bit 7. 1: ON 0: OFF		
			Bit 7	Error contact (terminal MA-MC) 1: ON 0: OFF		
Bits 8 to 15		Not used.				
---	---	000A to 000E	Not used.			
00	0F	000F	Reference selection settings			
			Bit 0	Not used.		
			Bit 1	PID target value (register 0006H) 1: Enabled 0: Disabled		
			Bits 2 to 15		Not used.	

Note Set all unused bits to 0.

10-6-2 Inverter Monitoring Functions (Read)

Class 64		Register No. (Hex)	Contents	
In-stance	At-tribute			
00	20	0020	Inverter status	
			Bit 0	Operation 1: Operating 0: Stopped
			Bit 1	Reverse operation 1: Reverse operation 0: Forward operation or stopped
			Bit 2	Inverter startup complete 1: Completed 2: Not completed
			Bit 3	Error 1: Error
			Bit 4	Data setting error 1: Error
			Bit 5	Multi-function contact output (terminal M1-M2) 1: ON 0: OFF
			Bit 6	Multi-function contact output (terminal M3-M4) 1: ON 0: OFF
		Bits 7 to 15	Not used.	
00	21	0021	Error details	
			Bit 0	Overcurrent (OC), ground fault (GF)
			Bit 1	Main circuit overvoltage (OV)
			Bit 2	Inverter overload (OL2)
			Bit 3	Inverter overheat (OH1)
			Bit 4	Not used.
			Bit 5	Fuse blown (PUF)
			Bit 6	PID feedback reference lost (FbL)
			Bit 7	External error (EF, EFO)
			Bit 8	Hardware error (CPF)
			Bit 9	Motor overload (OL1) or overtorque 1 (OL3) detected
			Bit 10	Not used.
			Bit 11	Main circuit undervoltage (UV) detected
			Bit 12	Main circuit undervoltage (UV1), control power supply error (UV2), inrush prevention circuit error (UV3)
			Bit 13	Not used.
Bit 14	RS-422A/485 communications error (CE)			
Bit 15	Operator disconnected (OPR)			
00	22	0022	Data link status	
			Bit 0	Writing data
			Bits 1 and 2	Not used.
			Bit 3	Upper and lower limit errors
			Bit 4	Data integrity error
		Bits 5 to 15	Not used.	
00	23	0023	Frequency reference	Monitors U1-01 (Unit set with o1-03.)
00	24	0024	Output frequency	Monitors U1-02 (Unit set with o1-03.)
00	25	0025	Output voltage reference	Monitors U1-06 (0.1-V units)

Class 64		Register No. (Hex)	Contents	
In-stance	At-tribute			
00	26	0026	Output current	Monitors U1-03 (Inverters of 7.5 kW or less: 0.01-A units, Inverters of 11 kW or more: 0.1-A units)
00	27	0027	Output power	Monitors U1-08 (0.1-kW units)
---	---	0028 to 002A	Not used.	
00	2B	002B	Sequence input status	
			Bit 0	Multi-function input terminal S1 1: ON 0: OFF
			Bit 1	Multi-function input terminal S2 1: ON 0: OFF
			Bit 2	Multi-function input terminal S3 1: ON 0: OFF
			Bit 3	Multi-function input terminal S4 1: ON 0: OFF
			Bit 4	Multi-function input terminal S5 1: ON 0: OFF
			Bit 5	Multi-function input terminal S6 1: ON 0: OFF
			Bit 6	Multi-function input terminal S7 1: ON 0: OFF
		Bits 7 to F	Not used.	
00	2C	002C	Inverter status	
			Bit 0	Operation 1: Operating
			Bit 1	Zero speed 1: Zero speed
			Bit 2	Frequency matching 1: Matched
			Bit 3	User-defined speed matching 1: Matched
			Bit 4	Frequency detection 1 1: Output frequency \leq L4-01
			Bit 5	Frequency detection 2 1: Output frequency \geq L4-01
			Bit 6	Inverter startup completed 1: Startup completed
			Bit 7	Low voltage detection 1: Detected
			Bit 8	Baseblock 1: Inverter output baseblock
			Bit 9	Frequency reference mode 1: Not communications 0: Communications
			Bit A	Run command mode 1: Not communications 0: Communications
			Bit B	Overtorque detection 1: Detected
			Bit C	Frequency reference lost 1: Lost
Bit D	Retrying error 1: Retrying			
Bit E	fault (including RS-422A/485 communications time-out) 1: fault occurred			
Bit F	Communications time-out 1: Timed out			
00	2D	002D	Multi-function output status	
			Bit 0	Multi-function output (terminal M1-M2) 1: ON 0: OFF
			Bit 1	Multi-function output (terminal M3-M4): 1: ON 0: OFF
			Bits 2 to F	Not used.
---	---	002E to 0030	Not used.	
00	31	0031	Main circuit DC voltage	Monitors U1-07 (1-V units)
---	---	0032 to 0037	Not used.	
00	38	0038	PID feedback quantity	1% = 10; 100% = Input corresponding to max. output frequency; without sign

Class 64		Register No. (Hex)	Contents	
In-stance	At-tribute			
00	39	0039	PID input quantity	1% = 10; 100% = Max. output frequency; without sign
00	3A	003A	PID output quantity	1% = 10; 100% = Max. output frequency; without sign
00	3B	003B	CPU software number	
00	3C	003C	Flash software number	
00	3D	003D	Communications error details	
			Bit 0	CRC error
			Bit 1	Invalid data length
			Bit 2	Not used.
			Bit 3	Parity error
			Bit 4	Overrun error
			Bit 5	Framing error
			Bit 6	Time-out
00	3E	003E	kVA setting	
00	3F	003F	Control method	
00	40	0040	Frequency reference	Monitors U1-01; 0.01-Hz units (units set in o1-03; with sign)
00	41	0041	Output frequency	Monitors U1-02; 0.01-Hz units (units set in o1-03; with sign)
00	42	0042	Output current	Monitors U1-03; % units: 8192 at rated current
---	---	0043 and 0044	Not used.	
00	45	0045	Output voltage	Monitors U1-06; 0.1-V units
00	46	0046	Main circuit DC voltage	Monitors U1-07; 1-V units
00	47	0047	Output power	Monitors U1-08; 0.1-kW units (with sign)
---	---	0048	Not used.	
00	49	0049	Input terminal status	Monitors U1-10; 1: ON. Bits 0 to 6 correspond to terminals S1 to S7.
00	4A	004A	Output terminal status	
			Monitors U1-11	
			Bit 0	Terminals M1 and M2; 1: ON
			Bit 1	Terminals M3 and M4; 1: ON
			Bits 2 to 6	Not used.
Bit 7	Terminals MA and MC; 1: ON			
Bits 8 to F	Not used.			

Class 64		Register No. (Hex)	Contents		
In-stance	At-tribute				
00	4B	004B	Operating status	Monitors U1-12	
				Bit 0	During RUN
				Bit 1	Zero speed
				Bit 2	Forward/reverse (1: Reverse operation)
				Bit 3	During fault reset input
				Bit 4	Frequency agree
				Bit 5	Operation ready
				Bit 6	Alarm (minor fault)
				Bit 7	Fault
Bits 8 to F	Not used.				
00	4C	004C	Cumulative operation time	Monitors U1-13; 1-hr units	
00	4D	004D	FLASH ID software No.	Monitors U1-14	
00	4E	004E	Frequency reference (voltage): Terminal A1 input value	Monitors U1-15; 0.1% units (100% = 10 V; with sign for + voltage setting)	
00	4F	004F	Multi-function analog input: Terminal A2 input value	Monitors U1-16; 0.1% units (100%=20 mA or 100% = 10 V; with sign for ± voltage setting)	
---	---	0051 and 0052	Not used.		
00	53	0053	Output frequency after a soft start	Monitors U1-20; 0.01-Hz units (with sign)	
---	---	0054 and 0055	Not used.		
00	57	0057	PID feedback	Monitors U1-24; 0.01% units (input corresponding to max. frequency = 100%; with sign)	
---	---	0059 and 005A	Not used.		
00	5B	005B	CPU ID	Monitors U1-28	
---	---	005F and 0060	Not used.		
00	61	0061	OPE error parameter	Monitors U1-34; outputs parameter	
00	63	0063	PID input quantity	Monitors U1-36; 0.01% units (max. frequency = 100%; with sign)	
00	64	0064	PID output quantity	Monitors U1-37; 0.01% units (max. frequency = 100%; with sign)	
00	65	0065	PID reference	Monitors U1-38; 0.01% units (max. frequency = 100%)	

Class 64		Register No. (Hex)	Contents						
In-stance	At-tribute								
00	66	0066	RS-422A/ 485 commu- nications error	Monitors U1-39					
				Bit 0	CRC error				
				Bit 1	Invalid data length				
				Bit 2	Not used.				
				Bit 3	Parity error				
				Bit 4	Overrun error				
				Bit 5	Framing error				
				Bit 6	Time-out				
Bits 7 to F	Not used.								
00	68	0068	Fan operat- ing time	Monitors U1-40; 1-hr units					
00	80	0080	Current fault	Monitors U2-01					
				Code	Error display	Code	Error display	Code	Error display
				01	PUF	0E	---	1C	---
				02	UV1	0F	---	1D	OH3
				03	UV2	10	---	1E	OPR
				04	UV3	11	EF3	1F	ERR
				06	GF	12	EF4	20	OH4
				07	OC	13	EF5	22	BUS
				08	OV	14	EF6	25	CF
				09	OH	15	EF7	27	EF0
				0A	OH1	18	---	28	FBL
				0B	OL1	19	---	29	IL3
				0C	OL2	1A	---	2A	---
0D	OL3	1B	---	2B	OL7				
00	81	0081	Last fault	Monitors U2-02 (same codes as U2-01)					
00	82	0082	Fault fre- quency refer- ence	Monitors U2-03; 0.01-Hz units (units set in o1-03; with sign)					
00	83	0083	Fault output reference	Monitors U2-04; 0.01-Hz units (units set in o1-03; with sign)					
00	84	0084	Fault output current	Monitors U2-05; Inverters of 7.5 kW or less: 0.01-A units, Inverters of 11 kW or more: 0.1-A units					
---	---	0085	Not used.						
00	86	0086	Fault output voltage refer- ence	Monitors U2-07; 0.1-V units					
00	87	0087	Fault main circuit DC voltage	Monitors U2-08; 1-V units					
00	88	0088	Fault output power	Monitors U2-09; 0.1-kW units (with sign)					
---	---	0089	Not used.						

Class 64		Register No. (Hex)	Contents	
In-stance	At-tribute			
00	8A	008A	Fault input terminal status	Monitors U2-11 (same contents as U1-10)
00	8B	008B	Fault output terminal status	Monitors U2-12 (same contents as U1-11)
00	8C	008C	Fault operating status	Monitors U2-13 (same contents as U1-12)
00	8D	008D	Fault cumulative operation time	Monitors U2-14; 1-hr units
00	8D	008D	Fault cumulative operation time	Monitors U2-14; 1-hr units
08	00	0090 (0800)	Content of last fault	Monitors U3-01 (same codes as U2-01)
08	01	0091 (0801)	Content of 2nd prior fault	Monitors U3-02 (same codes as U2-01)
08	02	0092 (0802)	Content of 3rd prior fault	Monitors U3-03 (same codes as U2-01)
08	03	0093 (0803)	Content of 4th prior fault	Monitors U3-04 (same codes as U2-01)
08	0A	0094 (080A)	Cumulative operation time since last fault	Monitors U3-05; 1-hr units
08	0B	0095 (080B)	Cumulative operation time since 2nd prior fault	Monitors U3-06; 1-hr units
08	0C	0096 (080C)	Cumulative operation time since 3rd prior fault	Monitors U3-07; 1-hr units
08	0D	0097 (080D)	Cumulative operation time since 4th prior fault	Monitors U3-08; 1-hr units
08	04	0804	Content of 5th prior fault	Monitors U3-09 (same codes as U2-01) (See note.)
08	05	0805	Content of 6th prior fault	Monitors U3-10 (same codes as U2-01) (See note.)
08	06	0806	Content of 7th prior fault	Monitors U3-11 (same codes as U2-01) (See note.)
08	07	0807	Content of 8th prior fault	Monitors U3-12 (same codes as U2-01) (See note.)
08	08	0808	Content of 9th prior fault	Monitors U3-13 (same codes as U2-01) (See note.)

Class 64		Register No. (Hex)	Contents	
In-stance	At-tribute			
08	09	0809	Content of 10th prior fault	Monitors U3-14 (same codes as U2-01) (See note.)
08	0E	080E	Cumulative operation time since 5th prior fault	Monitors U3-15; 1-hr units (See note.)
08	0F	080F	Cumulative operation time since 6th prior fault	Monitors U3-16; 1-hr units (See note.)
08	10	0810	Cumulative operation time since 7th prior fault	Monitors U3-17; 1-hr units (See note.)
08	11	0811	Cumulative operation time since 8th prior fault	Monitors U3-18; 1-hr units (See note.)
08	12	0812	Cumulative operation time since 9th prior fault	Monitors U3-19; 1-hr units (See note.)
08	13	0813	Cumulative operation time since 10th prior fault	Monitors U3-20; 1-hr units (See note.)

10-6-3 Parameter Reading and Writing

The following tables show the SYSDRIVE 3G3PV Inverter parameter and the corresponding register numbers. Write and read the various parameters with "1" as the minimum setting unit. Negative numbers are expressed as two's complement. If the setting unit is in hexadecimal, there is no need to convert it.

When writing data in parameters, be sure to send an enter command to enable the written data. Unless the enter command is transmitted, the data will not be enabled and the Inverter may not start.

■ Parameters for Initialize Mode

Parameter	Register No. (Hex)	Class 64 (Hex)		Name	Setting range	Setting unit	Default setting	Changes during operation
		Instance	Attribute					
A1-01	0101	01	01	Parameter access level	0 to 2	1	2	Yes
A1-03	0103	01	03	Initialize	0 to 3,330	1	0	No
A1-04	0104	01	04	Password	0 to 9,999	1	0	No
A1-05	0105	01	05	Password setting	0 to 9,999	1	0	No

■ Application Parameters

Parameter	Register No. (Hex)	Class 64 (Hex)		Name	Setting range	Setting unit	Default setting	Changes during operation
		Instance	Attribute					
b1-01	0180	01	80	Reference selection	0 to 3	1	1	No
b1-02	0181	01	81	Operation method selection	0 to 3	1	1	No
b1-03	0182	01	82	Stopping method selection	0 to 3	1	0	No
b1-07	0183	01	86	Operation selection after switching to remote mode	0 or 1	1	0	No
b1-08	0187	01	87	Run command selection in programming modes	0 or 1	1	0	No
b2-01	0189	01	89	Zero speed level (DC injection braking starting frequency)	0.0 to 10.0	0.1 Hz	0.5	No
b2-02	018A	01	8A	DC injection braking current	0 to 100	1%	50	No
b2-03	018B	01	93	DC injection braking time at start	0.00 to 10.00	0.01 s	0.00	No
b2-04	018C	01	8C	DC Injection braking time at stop	0.00 to 10.00	0.01 s	0.50	No
b3-01	0191	01	91	Speed search selection (current detection or speed calculation)	2 or 3	1	2	No
b3-02	0192	01	92	Speed search operating current (current detection)	0 to 200	1%	120	No
b3-03	0193	01	93	Speed search deceleration time (current detection)	0.1 to 10.0	0.1 s	2.0	No
b3-05	0195	01	95	Speed search wait time (current detection or speed calculation)	0.0 to 20.0	0.1 s	0.2	No
b5-01	01A5	01	A5	PID control mode selection	0 or 1	1	0	No
b5-02	01A6	01	A6	Proportional gain (P)	0.00 to 25.00	0.01	1.00	Yes
b5-03	01A7	01	A7	Integral (I) time	0.0 to 360.0	0.1 s	1.0	Yes
b5-04	01A8	01	A8	Integral (I) limit	0.0 to 100.0	0.1%	100.0	Yes

Parameter	Register No. (Hex)	Class 64 (Hex)		Name	Setting range	Setting unit	Default setting	Changes during operation
		Instance	Attribute					
b5-06	01AA	01	AA	PID limit	0.0 to 100.0	0.1%	100.0	Yes
b5-07	01AB	01	AB	PID offset adjustment	-100.0 to 100.0	0.1%	0.0	Yes
b5-08	01AC	01	AC	PID primary delay time constant	0.00 to 10.00	0.01 s	0.00	Yes
b5-12	01B0	01	B0	Selection of PID feedback command loss detection	0 to 2	1	0	No
b5-13	01B1	01	B1	PID feedback command loss detection level	0 to 100	1%	0	No
b5-14	01B2	01	B2	PID feedback command loss detection time	0.0 to 25.5	0.1 s	1.0	No
b5-15	01B3	01	B3	PID sleep function operation level	0.0 to 400.0	0.1 Hz	0.0	No
b5-16	01B4	01	B4	PID sleep operation delay time	0.0 to 25.5	0.1 s	0.0	No
b5-17	01B5	01	B5	Accel/decel time for PID reference	0.0 to 25.5	0.1 s	0.0	No
b8-01	01CC	01	CC	Energy-saving mode selection	0 or 1	1	0	No
b8-04	01CF	01	CF	Energy-saving coefficient	0.00 to 655.00 (See note.)	0.01	Depends on capacity.	No
b8-05	01D0	01	D0	Power detection filter time constant	0 to 2,000	1 ms	20	No
b8-06	01D1	01	D1	Search operation voltage limiter	0 to 100	1%	0	No

Note The same capacity as the Inverter can be set by initializing this parameter.

■ Tuning Parameters

Parameter	Register No. (Hex)	Class 64 (Hex)		Name	Setting range	Setting unit	Default setting	Changes during operation
		Instance	Attribute					
C1-01	0200	02	00	Acceleration time 1	0.0 to 600.0	0.1 s	10.0	Yes
C1-02	0201	02	01	Deceleration time 1				Yes
C1-03	0202	02	02	Acceleration time 2				Yes
C1-04	0203	02	03	Deceleration time 2				Yes
C1-09	0208	02	08	Deceleration Stop Time				No
C1-11	020A	02	0A	Accel/decel time switching frequency	0.0 to 400.0	0.1 Hz	0.0	No
C2-01	020B	02	0B	S-curve characteristic time at acceleration start	0.00 to 2.50	0.01 s	0.20	No
C2-02	020C	02	0C	S-curve characteristic time at acceleration end	0.00 to 2.50	0.01 s	0.20	No

Parameter	Register No. (Hex)	Class 64 (Hex)		Name	Setting range	Setting unit	Default setting	Changes during operation
		Instance	Attribute					
C4-01	0215	02	15	Torque compensation gain	0.00 to 2.50	0.01	1.00	Yes
C4-02	0216	02	16	Torque compensation primary delay time constant	0 to 10,000	1 ms	200 (See note 1.)	No
C6-02	0224	02	24	Carrier frequency selection	1 to F	1	Depends on capacity.	No
C6-03	0225	02	25	Carrier frequency upper limit	2.0 to 15.0 (See notes 2 and 3.)	0.1 kHz	Depends on capacity.	No
C6-04	0226	02	26	Carrier frequency lower limit	0.4 to 15.0 (See notes 2 and 3.)	0.1 kHz	Depends on capacity.	No
C6-05	0227	02	27	Carrier frequency proportional gain	00 to 99 (See note 3.)	1	00	No

Note 1. When the control mode is changed, the Inverter will revert to default settings. (The V/f control default setting is given above.)

Note 2. The setting range depends on the capacity of the Inverter.

Note 3. These parameters can be monitored or set only when F is set for C6-02.

■ Reference Parameters

Parameter	Register No. (Hex)	Class 64 (Hex)		Name	Setting range	Setting unit	Default setting	Changes during operation
		Instance	Attribute					
d1-01	0280	02	80	Frequency reference 1	0 to max. output frequency	0.01 Hz (Set with o1-03.)	0.00	Yes
d1-02	0281	02	81	Frequency reference 2			0.00	Yes
d1-03	0282	02	82	Frequency reference 3			0.00	Yes
d1-04	0283	02	83	Frequency reference 4			0.00	Yes
d1-17	0292	02	92	Jog frequency reference			6.00	Yes
d2-01	0289	02	89	Frequency reference upper limit	0.0 to 110.0	0.1%	100.0	No
d2-02	028A	02	8A	Frequency reference lower limit	0.0 to 110.0	0.1%	0.0	No
d2-03	0293	02	93	Master speed reference lower limit	0.0 to 110.0	0.1%	0.0	No

Parameter	Register No. (Hex)	Class 64 (Hex)		Name	Setting range	Setting unit	Default setting	Changes during operation
		Instance	Attribute					
d3-01	0294	02	94	Jump frequency 1	0.0 to 400.0	0.1 Hz	0.0	No
d3-02	0295	02	95	Jump frequency 2		0.1 Hz	0.0	No
d3-03	0296	02	96	Jump frequency 3		0.1 Hz	0.0	No
d3-04	0297	02	97	Jump frequency width	0.0 to 20.0	0.1 Hz	1.0	No
d6-01	02A0	02	A0	Field weakening level	0 to 100	1%	80	No
d6-02	02A1	02	A1	Field frequency	0.0 to 400.0	0.1 Hz	0.0	No

■ Motor Constant Parameters

Parameter	Register No. (Hex)	Class 64 (Hex)		Name	Setting range	Setting unit	Default setting	Changes during operation
		Instance	Attribute					
E1-01	0300	03	00	Input voltage setting	155 to 255 (155 to 510) (See note 1.)	1 V	200 (400) (See note 1.)	No
E1-03	0302	03	02	V/f pattern selection	0 to F E cannot be set.	1	F	No
E1-04	0303	03	03	Max. output frequency	0.0 to 120.0	0.1 Hz	50.0	No
E1-05	0304	03	04	Max. voltage	0.0 to 255.0 (0.0 to 510.0) (See note 1.)	0.1 V	200.0 (400.0) (See note 1.)	No
E1-06	0305	03	05	Base frequency	0.0 to 120.0	0.1 Hz	50.0	No
E1-07	0306	03	06	Mid. output frequency	0.0 to 120.0	0.1 Hz	3.0	No
E1-08	0307	03	07	Mid. output frequency voltage	0.0 to 255 (0.0 to 510.0) (See note 1.)	0.1 V	15.0 (30.0) (See note 1.)	No
E1-09	0308	03	08	Min. output frequency	0.0 to 120.0	0.1 Hz	1.5	No

Parameter	Register No. (Hex)	Class 64 (Hex)		Name	Setting range	Setting unit	Default setting	Changes during operation
		Instance	Attribute					
E1-10	0309	03	09	Min. output frequency voltage	0.0 to 255.0 (0.0 to 510.0) (See note 1.)	0.1 V	9.0 (18.0) (See note 1.)	No
E1-11	030A	03	0A	Mid. output frequency 2	0.0 to 120.0	0.1 Hz	0.0 (See note 2.)	No
E1-12	030B	03	0B	Mid. output frequency voltage 2	0.0 to 255.0 (0.0 to 510.0) (See note 1.)	0.1 V	0.0 (See note 2.)	No
E1-13	030C	03	0C	Base voltage	0.0 to 255.0 (0.0 to 510.0) (See note 1.)	0.1 V	0.0 (See note 3.)	No
E2-01	030E	03	0E	Motor rated current	0.32 to 6.40 (See note 4.)	0.01 A	Depends on capacity.	No
E2-05	0312	03	12	Motor line-to-line resistance	0.000 to 65.000	0.001 Ω	Depends on capacity.	No

Note 1. Values in parentheses are for 400-V-class Inverters.

Note 2. The settings of E1-11 and E1-12 are ignored if set to 0.0.

Note 3. E1-13 will be the same value as E1-05 after autotuning.

Note 4. The setting range is 10% to 200% of the Inverter's rated output current. The values for a 200-V-class 0.4-kW Inverter are given above.

■ Option Parameters

Parameter	Register No. (Hex)	Class 64 (Hex)		Name	Setting range	Setting unit	Default setting	Changes during operation
		In-stance	At-tribute					
F6-01	03A2	03	A2	DeviceNet fault operation selection	0 to 3	1	1	No
F6-02	03A3	03	A3	Communications external fault input detection method selection	0 or 1	1	0	No
F6-03	03A4	03	A4	Communications external fault input operation selection	0 to 3	1	1	No
F6-05	03A6	03	A6	Display unit selection for current monitor	0 or 1	1	0	No

■ External Terminal Function Parameters

Parameter	Register No. (Hex)	Class 64 (Hex)		Name	Setting range	Setting unit	Default setting	Changes during operation
		In-stance	At-tribute					
H1-01	0400	04	00	Terminal S3 function selection	0 to 6A	1	24	No
H1-02	0401	04	01	Terminal S4 function selection	0 to 6A	1	14	No
H1-03	0402	04	02	Terminal S5 function selection	0 to 6A	1	3 (0) (See note1.)	No
H1-04	0403	04	03	Terminal S6 function selection	0 to 6A	1	4 (3) (See note1.)	No
H1-05	0404	04	04	Terminal S7 function selection	0 to 6A	1	6 (4) (See note1.)	No
H2-01	040B	04	0B	Terminal M1-M2 Select	0 to 38	1	0	No
H2-02	040C	04	0C	Terminal M3-M4 select	0 to 38	1	1	No
H3-02	0411	04	11	Gain (terminal A1)	0.0 to 1,000.0	0.1%	100.0	Yes
H3-03	0412	04	12	Bias (terminal A1)	-100.0 to 100.0	0.1%	0.0	Yes
H3-08	0417	04	17	Multi-function analog input terminal A2 signal level selection	0 or 2	1	2	No
H3-09	0418	04	18	Multi-function analog input terminal A2 function selection	0 to 1F	1	0	No
H3-10	0419	04	19	Gain (terminal A2)	0.0 to 1,000.0	0.1%	100.0	Yes
H3-11	041A	04	1A	Bias (terminal A2)	-100.0 to 100.0	0.1%	0.0	Yes
H3-13	041C	04	1C	Terminal A1/A2 switching	0 or 1	1	0	No

Parameter	Register No. (Hex)	Class 64 (Hex)		Name	Setting range	Setting unit	Default setting	Changes during operation
		Instance	Attribute					
H4-01	041D	04	1D	Monitor selection (terminal FM)	1 to 40	1	2	No
H4-02	041E	04	1E	Gain (terminal FM)	0.0 to 1,000.0	0.1%	100.0	Yes
H4-03	041F	04	1F	Bias (terminal FM)	-110.0 to 110.0	0.1%	0.0	Yes
H4-04	0420	04	20	Monitor selection (terminal AM)	1 to 40	1	3	No
H4-05	0421	04	21	Gain (terminal AM)	0.0 to 1,000.0	0.1%	50.0	Yes
H4-06	0422	04	22	Bias (terminal AM)	-110.0 to 110.0	0.1%	0.0	Yes
H4-07	0423	04	23	Analog output 1 signal level selection	0 or 2	1	0	No
H4-08	0424	04	24	Analog output 2 signal level selection	0 or 2	1	0	No
H5-01	0425	04	25	Slave address	0 to 20 (See note 2.)	1	1F	No
H5-02	0426	04	26	Communication speed selection	0 to 4	1	3	No
H5-03	0427	04	27	Communication parity selection	0 to 2	1	0	No
H5-04	0428	04	28	Stopping method after communication error	0 to 3	1	3	No
H5-05	0429	04	29	Communication error detection selection	0 or 1	1	1	No
H5-06	042A	04	2A	Send wait time	5 to 65	1 ms	5	No
H5-07	042B	04	2B	RTS control ON/OFF	0 or 1	1	1	No

Note 1. The values in parentheses indicate initial values when initialized in 3-wire sequence.

Note 2. Set H5-01 to 0 to disable Inverter responses to RS-422A/485 communications.

■ Protective Function Parameters

Parameter	Register No. (Hex)	Class 64 (Hex)		Name	Setting range	Setting unit	Default setting	Changes during operation
		Instance	Attribute					
L1-01	0480	04	80	Motor protection selection	0 or 1	1	1	No
L1-02	0481	04	81	Motor protection time constant	0.1 to 5.0	0.1 min	1.0	No
L1-03	0482	04	82	Alarm operation selection during motor overheating	0 to 3	1	3	No
L1-04	0483	04	83	Motor overheating operation selection	0 to 2	1	1	No
L1-05	0484	04	84	Motor temperature input filter time constant	0.00 to 10.00	0.01 s	0.20	No

Parameter	Register No. (Hex)	Class 64 (Hex)		Name	Setting range	Setting unit	Default setting	Changes during operation
		In-stance	At-tribute					
L2-01	0485	04	85	Momentary power loss detection	0 to 2	1	0	No
L2-02	0486	04	86	Momentary power loss ride-thru time	0 to 2.0	0.1 s	Depends on capacity.	No
L2-03	0487	04	87	Min. baseblock time	0.1 to 5.0	0.1 s	Depends on capacity.	No
L2-04	0488	04	88	Voltage recovery time	0.0 to 5.0	0.1 s	Depends on capacity.	No
L2-05	0489	04	89	Undervoltage detection level	150 to 210 (150 to 420) (See note.)	1 V	190 (380) (See note.)	No
L3-01	048F	04	8F	Stall prevention selection during accel	0 to 2	1	1	No
L3-02	0490	04	90	Stall prevention level during accel	0 to 200	1%	120	No
L3-04	0492	04	92	Stall prevention selection during decel	0 to 2	1	1	No
L3-05	0493	04	93	Stall prevention selection during running	0 to 2	1	1	No
L3-06	0494	04	94	Stall prevention level during running	30 to 200	1%	120	No
L4-01	0499	04	99	Speed agreement detection level	0.0 to 400.0	0.1 Hz	0.0	No
L4-02	049A	04	9A	Speed agreement detection width	0.0 to 20.0	0.1 Hz	2.0	No
L4-05	049D	04	9D	Operation when frequency reference is lost	0 or 1	1	0	No
L4-06	04C2	04	C2	Frequency reference for loss of frequency reference	0.0 to 100.0	0.1%	80.0	No
L5-01	049E	04	9E	Number of auto restart attempts	0 to 10	1	0	No
L5-02	049F	04	9F	Auto restart operation selection	0 or 1	1	0	No
L6-01	04A1	04	A1	Torque detection selection 1	0 to 8	1	0	No
L6-02	04A2	04	A2	Torque detection level 1	0 to 300	1%	150	No
L6-03	04A3	04	A3	Torque detection time 1	0.0 to 10.0	0.1 s	0.1	No

Parameter	Register No. (Hex)	Class 64 (Hex)		Name	Setting range	Setting unit	Default setting	Changes during operation
		Instance	Attribute					
L8-02	04AE	04	AE	Overheat pre-alarm level	50 to 130	1°C	Depends on capacity.	No
L8-03	04AF	04	AF	Operation selection after overheat pre-alarm	0 to 3	1	3	No
L8-09	04B5	04	B5	Ground protection selection	0 or 1	1	1	No
L8-11	04B7	04	B7	Cooling fan control delay time	0 to 300	1 s	60	No
L8-12	04B8	04	B8	Ambient temperature	45 to 60	1°C	45	No
L8-15	04BB	04	BB	OL2 characteristics selection at low speeds	0 or 1	1	1	No

Note Values in parentheses are for 400-V-class Inverters.

■ Special Adjustment Parameters

Parameter	Register No. (Hex)	Class 64 (Hex)		Name	Setting range	Setting unit	Default setting	Changes during operation
		Instance	Attribute					
N1-01	0580	05	80	Hunting-prevention function selection	0 or 1	1	1	No
N1-02	0581	05	81	Hunting-prevention gain	0.00 to 2.50	0.01	1.00	No
N3-01	0588	05	88	High-slip braking deceleration frequency width	1 to 20	1%	5	No
N3-02	0589	05	89	High-slip braking current limit	100 to 200	1%	150	No
N3-03	058A	05	8A	High-slip braking stop dwell time	0.1 to 10.0	0.1 s	1.0	No
N3-04	058B	05	8B	High-slip braking OL time	30 to 1200	1 s	40	No

■ Operator Parameters

Parameter	Register No. (Hex)	Class 64 (Hex)		Name	Setting range	Setting unit	Default setting	Changes during operation
		Instance	Attribute					
o1-01	0500	05	00	Monitor selection	4 to 40	1	6	Yes
o1-02	0501	05	01	Monitor selection after power up	1 to 4	1	1	Yes
o1-03	0502	05	02	Frequency units of reference setting and monitor	0 to 39,999	1	0	No
o1-05	0504	05	04	LCD brightness	0 to 5	1	3	Yes
o2-01	0505	05	05	LOCAL/REMOTE key enable/disable	0 or 1	1	1	No

Parameter	Register No. (Hex)	Class 64 (Hex)		Name	Setting range	Setting unit	Default setting	Changes during operation
		Instance	Attribute					
o2-02	0506	05	06	STOP key during control circuit terminal operation	0 or 1	1	1	No
o2-03	0507	05	07	Parameter initial value	0 to 2	1	0	No
o2-04	0508	05	08	kVA selection	0 to FF	1	Depends on capacity.	No
o2-05	0509	05	09	Frequency reference setting method selection	0 or 1	1	0	No
o2-06	050A	05	0A	Operation selection when digital operator is disconnected	0 or 1	1	0	No
o2-07	050B	05	0B	Cumulative operation time setting	0 to 65,535	1 hr	0	No
o2-08	050C	05	0C	Cumulative operation time selection	0 or 1	1	1	No
o2-09	050D	05	0D	Initialize mode	---	---	---	No
o2-10	050E	05	0E	Fan operation time setting	0 to 65,535	1 hr	0	No
o2-12	0510	05	10	Fault history initialization	0 or 1	1	0	No

10-7 3G3FV Register Numbers, Classes, Instances, and Attributes

10-7-1 Inputting Control/Frequency

The Inverter's various control inputs are allocated to the registers shown in the following table. For example, to set the frequency reference and begin operation, first set the reference value to the frequency reference register "0001," and then write the run command to the Inverter's run command register "0000."

Note 1. Set values are retained until changed by the next writing operation.

Note 2. The following registers are in RAM, so they are all cleared to zero when the Inverter's power supply is turned OFF.

Class 64		Register number (hex)	Function	Content
Instance	Attribute			
00	00	0000	Inverter run command	(Refer to table below.)
00	01	0001	Frequency reference	Sets frequency reference value. (See note 1.)
---	---	0002 to 0006	Not used.	---
00	07	0007	Multi-function analog output 1 (See note 2.)	+11 V = 02D6 hex
00	08	0008	Multi-function analog output 2 (See note 2.)	+11 V = 02D6 hex
00	09	0009	Inverter output (See note 3.)	(Refer to table below.)
---	---	000A to 000F	Not used.	---

● Inverter Run Commands: Register Number 0000 Hex

Bit	Content
0	Forward/stop (1: Forward operation)
1	Reverse/stop (1: Reverse operation)
2	Multi-function input 1
3	Multi-function input 2
4	Multi-function input 3
5	Multi-function input 4
6	Multi-function input 5
7	Multi-function input 6
8 to 15	Not used.

● Inverter Outputs: Register Number 0009 Hex

Bit	Content
0	Multi-function contact output (1: ON)
1	Multi-function output 1 (1: ON)
2	Multi-function output 2 (1: ON)
3 to 15	Not used.

- Note 1.** The setting unit of the frequency reference can be changed in o1-03 (frequency reference setting and display units). The default setting is 0.01 Hz.
- Note 2.** The multi-function analog output 1 and 2 registers can be used to set the Inverter's analog outputs by means of communications. To do that, set “31 (1F hex)” for H4-01 (multi-function analog output terminal 21 monitor selection) and H4-04 (multi-function analog output terminal 23 monitor selection).
- Note 3.** The Inverter's multi-function outputs can be turned from ON to OFF by means of communications. To do that, set “F” for multi-function output parameters H2-01 (multi-function contact output: terminals 9-10 function selection), H2-02 (multi-function output 1: terminal 25 function selection), and H2-03 (multi-function output 2: terminal 26 function selection).

10-7-2 Inverter Monitoring Functions

All Inverter monitoring can be accessed. To read Inverter status, fault monitoring, alarm monitoring, I/O status monitoring, error log, etc., specify the register number from the following table and read the data.

Class 64		Register number (hex)	Function	Content
Instance	Attribute			
00	10	0010	Inverter status	(Refer to table below.)
00	11	0011	Operator status	(Refer to table below.)
00	12	0012	Operator setting error number	OPE error number
---	---	0013	Not used.	---
00	14	0014	Fault 1	(Refer to table below.)
00	15	0015	Fault 2	(Refer to table below.)
00	16	0016	Fault 3	(Refer to table below.)
00	17	0017	CPF error 1	(Refer to table below.)
00	18	0018	CPF error 2	(Refer to table below.)
00	19	0019	Alarm 1	(Refer to table below.)
00	1A	001A	Alarm 2	(Refer to table below.)
---	---	001B to 001F	Not used.	---

● Inverter Status: Register Number 0010 Hex

Bit	Content
0	During Run
1	Zero speed
2	Forward/reverse (1: Reverse operation)
3	during Fault Reset input
4	Frequency agree 1
5	Inverter operation ready
6	Alarm
7	Fault
8 to 15	Not used.

● **Operator Status: Register Number 0011 Hex**

Bit	Content
0	1: Operation fault
1	1: EEPROM error
2	1: Program mode
3	00: Operator connecting
4	11: Operator disconnecting
5 to 15	Not used.

● **Fault 1: Register Number 0014 Hex**

Bit	Display	Content
0	PUF	Fuse open
1	UV1	Undervoltage (main)
2	UV2	Undervoltage (CTL)
3	UV3	Undervoltage (MC)
4	SC	Short-circuit
5	GF	Ground fault
6	OC	Overcurrent
7	OV	Overvoltage
8	OH	Overheat (See note 1.)
9	OH1	Overheat (See note 2.)
10	OL1	Motor overload
11	OL2	Inverter overload
12	OL3	Overtorque detection 1
13	OL4	Overtorque detection 2
14	RR	Braking transistor
15	RH	Braking resistor

Note 1. Maximum (upper limit) temperature was exceeded.

Note 2. Set temperature was exceeded.

● **Fault 2: Register Number 0015 Hex**

Bit	Display	Content
0	EF3	External fault (terminal 3)
1	EF4	External fault (terminal 4)
2	EF5	External fault (terminal 5)
3	EF6	External fault (terminal 6)
4	EF7	External fault (terminal 7)
5	EF8	External fault (terminal 8)
6	---	Not used.
7	OS	Overspeed
8	DEV	Speed deviation
9	PGO	PG is disconnected
10	PF	Input phase loss
11	LF	Output phase loss

Bit	Display	Content
12	---	Not used.
13	OPR	OPR disconnected
14	ERR	EEPROM error
15	---	Not used.

● **Fault 3: Register Number 0016 Hex**

Bit	Display	Content
0	---	Not used.
1	BUS	Communications error

● **CPF Error 1: Register Number 0017 Hex**

Bit	Display	Content
0	---	Not used.
1	---	Not used.
2	CPF02	Baseblock circuit error
3	CPF03	EEPROM error
4	CPF04	Internal A/D error (See note 1.)
5	CPF05	External A/D error (See note 2.)
6	CPF06	Option connect error
7 to 15	---	Not used.

Note 1. CPU internal A/D converter error

Note 2. CPU external A/D converter error

● **CPF Error 2: Register Number 0018 Hex**

Bit	Display	Content
0	CPF20	Optional Card A/D error
1 to 15	---	Not used.

● **Alarm 1: Register Number 0019 Hex**

Bit	Display	Content
0	UV	Undervoltage (main)
1	OV	Overvoltage
2	OH	Overheat
3	OH2	External overheat
4	OL3	Overtorque detection 1
5	OL4	Overtorque detection 2
6	EF	Forward/reverse simultaneous input
7	BB	Baseblock
8	EF3	External fault (terminal 3)
9	EF4	External fault (terminal 4)
10	EF5	External fault (terminal 5)
11	EF6	External fault (terminal 6)

Bit	Display	Content
12	EF7	External fault (terminal 7)
13	EF8	External fault (terminal 8)
14	---	Not used.
15	OS	Overspeed

● Alarm 2: Register Number 001A Hex

Bit	Display	Content
0	DEV	Speed deviation
1	PGO	PG is disconnected
2 to 15	---	Not used.

■ Inverter Monitoring: U1-□□

Class 64		Register number	Monitor number	Monitored item	Output unit
Instance	Attribute				
00	20	0020	U1-01	Frequency reference	Set in o1-03
00	21	0021	U1-02	Output frequency	Set in o1-03
00	22	0022	U1-03	Output current	8192 decimal = Inverter rated current
00	23	0023	U1-04	Control method	Set in A1-02
00	24	0024	U1-05	Motor speed	Set in o1-03
00	25	0025	U1-06	Output voltage	0.1 V
00	26	0026	U1-07	Main circuit DC voltage	1 V
00	27	0027	U1-08	Output power	0.1 kW
00	28	0028	U1-09	Torque reference	0.1%
00	29	0029	U1-10	Input terminal status	Bits 0 to 7 = terminals 1 to 8
00	2A	002A	U1-11	Output terminal status	(Refer to table below.)
00	2B	002B	U1-12	Operating status	(Refer to table below.)
00	2C	002C	U1-13	Elapsed time	1 hour
00	2D	002D	U1-14	FLASH ID software No.	---
00	2E	002E	U1-15	Terminal 13 level	0.1% (100% = 10 V)
00	2F	002F	U1-16	Terminal 14 level	0.1% (100% = 20 mA)
00	30	0030	U1-17	Terminal 16 level	0.1% (100% = 10 V)
00	31	0031	U1-18	Motor secondary current	0.1% (100%: Motor rated current)
00	32	0032	U1-19	Motor excitation current	0.1% (100%: Motor rated current)
00	33	0033	U1-20	Output frequency after a soft start	Set in o1-03
00	34	0034	U1-21	Input to speed control loop	0.01% (100%: Maximum frequency)
00	35	0035	U1-22	Output from speed control loop	0.1% (100%: Motor rated current)

Class 64		Register number	Monitor number	Monitored item	Output unit
Instance	Attribute				
00	36	0036	U1-23	Speed deviation	0.01% (100%: Maximum frequency)
00	37	0037	U1-24	PID feedback	0.01% (100%: Maximum frequency)
00	39	0039	U1-26	Voltage reference for secondary current	0.1 V
00	3A	003A	U1-27	Voltage reference for excitation current	0.1 V
00	3B	003B	U1-28	CPU ID	---

● Output Terminal Status: Register Number 002A Hex

Bit	Content
0	1: Terminal 9 and 10 short
1	1: Terminal 25 and 27 short
2	1: Terminal 26 and 27 short
3	Not used.
4	
5	
6	
7	1: Terminal 18 and 20 short
8 to 15	Not used.

● Operating Status: Register Number 002B Hex

Bit	Content
0	During Run
1	Zero speed
2	Forward/reverse (1: Reverse operation)
3	during Fault Reset input
4	Frequency agree 1
5	Operation ready
6	Alarm
7	Fault
8 to 15	Not used.

■ Inverter Monitoring: U2-□□, U3-□□

Class 64		Register number	Monitor number	Monitored item	Output unit
Instance	Attribute				
00	80	0080	U2-01	Current fault	(Refer to table below.)
00	81	0081	U2-02	Last fault	(Refer to table below.)
00	82	0082	U2-03	Fault frequency reference	Set in o1-03.
00	83	0083	U2-04	Fault output reference	Set in o1-03.
00	84	0084	U2-05	Fault output current	8192 decimal = Inverter rated current

Class 64		Register number	Monitor number	Monitored item	Output unit
Instance	Attribute				
00	85	0085	U2-06	Fault motor speed	Set in o1-03.
00	86	0086	U2-07	Fault output voltage reference	0.1 V
00	87	0087	U2-08	Fault main circuit DC voltage	1 V
00	88	0088	U2-09	Fault output power	0.1 kW
00	89	0089	U2-10	Fault torque reference	0.1%
00	8A	008A	U2-11	Fault input terminal status	Bits 0 to 7 = terminals 1 to 8
00	8B	008B	U2-12	Fault output terminal status	(Same as for U1-11 on previous page.)
00	8C	008C	U2-13	Fault operating status	(Same as for U1-12 on previous page.)
00	8D	008D	U2-14	Fault elapsed time	1 hour
00	90	0090	U3-01	Content of last fault	(Refer to table below.)
00	91	0091	U3-02	Content of 2nd prior fault	(Refer to table below.)
00	92	0092	U3-03	Content of 3rd prior fault	(Refer to table below.)
00	93	0093	U3-04	Content of 4th prior fault	(Refer to table below.)
00	94	0094	U3-05	Elapsed time since last fault	1 hour
00	95	0095	U3-06	Elapsed time since 2nd prior fault	1 hour
00	96	0096	U3-07	Elapsed time since 3rd prior fault	1 hour
00	97	0097	U3-08	Elapsed time since 4th prior fault	1 hour

● Error Codes

Code	Display	Content
01	PUF	Fuse open
02	UV1	Undervoltage (main)
03	UV2	Undervoltage (CTL)
04	UV3	Undervoltage (MC)
05	SC	Short-circuit
06	GF	Ground fault
07	OC	Overcurrent
08	OV	Overvoltage
09	OH	Overheat (See note 1.)
0A	OH1	Overheat (See note 2.)
0B	OL1	Motor overload
0C	OL2	Inverter overload
0D	OL3	Overtorque detection 1
0E	OL4	Overtorque detection 2
0F	RR	Braking transistor
10	RH	Braking resistor
11	EF3	External fault (Terminal 3)
12	EF4	External fault (Terminal 4)
13	EF5	External fault (Terminal 5)

Code	Display	Content
14	EF6	External fault (Terminal 6)
15	EF7	External fault (Terminal 7)
16	EF8	External fault (Terminal 8)
17	---	Not used.
18	OS	Overspeed
19	DEV	Speed deviation
1A	PGO	PG is disconnected
1B	PF	Input phase loss
1C	LF	Output phase loss
1D	---	Not used.
1E	OPR	OPR disconnected
1F	ERR	EEPROM error
21 to FF	---	Not used.

Note 1. Maximum (upper limit) temperature was exceeded.

Note 2. Set temperature was exceeded.

10-7-3 Parameter Reading and Writing

The following tables show the SYSDRIVE 3G3FV Inverter parameters and the corresponding register numbers. Write and read the various parameters with "1" as the minimum setting unit. Negative numbers are expressed as two's complement. If the setting unit is in hexadecimal, there is no need to convert it.

When writing data in parameters, be sure to send an enter command to enable the written data. Unless the enter command is transmitted, the data will not be enabled and the Inverter may not start.

■ Parameters for Initialize Mode

Constant	Register number (hex)	Class 64 (hex)		Name	Setting range	Setting unit	Default setting	Write during operation
		Instance	Attribute					
A1-00	0100	---	---	Display Language	0 to 6	1	1	Yes
A1-01	0101	01	01	Access Level	0 to 4	1	2	Yes
A1-02	0102	01	02	Select Control Method	0 to 3	1	2	No
A1-03	0103	---	---	Initialize	0 to 3330	1	0	No
A1-04	0104	---	---	Password	0 to 9999	1	0	No
A1-05	0105	---	---	Setting the Password	0 to 9999	1	0	No
A2-01 to A2-32	0106 to 0125	---	---	User-parameter settings	0180 to 050C Set the register numbers for b1-01 to o2-08.	---	---	No

■ Application Parameters

Constant	Register number (hex)	Class 64 (hex)		Name	Setting range	Setting unit	Default setting	Write during operation
		Instance	Attribute					
b1-01	0180	01	03	Frequency reference selection	0 to 3	1	1	No
b1-02	0181	01	04	Run source selection	0 to 3	1	1	No
b1-03	0182	01	05	Stopping method selection	0 to 3	1	0	No
b1-04	0183	01	06	Disabling reverse operation	0, 1	1	0	No
b1-05	0184	01	07	Operation selection for minimum frequency (E1-09 or less)	0 to 3	1	0	No
b1-06	0185	---	---	Setting control input responsiveness	0, 1	1	1	No
b1-07	0186	---	---	Operation selection after switching to remote mode	0, 1	1	0	No
b1-08	01A6	---	---	Run source selection when not in drive mode	0, 1	1	0	No
b2-01	0187	01	08	Excitation level (DC injection starting frequency)	0.0 to 10.0	0.1 Hz	0.5	No
b2-02	0188	01	09	DC injection braking current	0 to 100	1%	50	No
b2-03	0189	01	0A	DC injection braking time at start	0.00 to 10.00	0.01 s	0.00	No
b2-04	018A	01	0B	DC injection braking time at stop	0.00 to 10.00	0.01 s	0.50	No
b2-08	01AB	---	---	Magnetic flux compensation amount	0 to 500	1%	0	No
b3-01	018E	01	0C	Speed search selection at start	0, 1	1	0 (See note.)	No
b3-02	018F	01	0D	Speed search operation current	0 to 200	1%	100	No
b3-03	0190	01	0E	Speed search deceleration time	0.1 to 10.0	0.1 s	2.0	No
b4-01	0192	---	---	Timer function ON-delay time	0.0 to 300.0	0.1 s	0.0	No
b4-02	0193	---	---	Timer function OFF-delay time	0.0 to 300.0	0.1 s	0.0	No
b5-01	0194	01	0F	PID control selection	0 to 4	1	0	No
b5-02	0195	01	10	Proportional gain (P)	0.00 to 25.00	0.01	1.00	Yes
b5-03	0196	01	11	Integral time (I)	0.0 to 360.0	0.1 s	1.0	Yes
b5-04	0197	01	12	Integral limit (I)	0.0 to 100.0	0.1%	100.0	Yes
b5-05	0198	01	13	Differential time (D)	0.00 to 10.00	0.01 s	0.00	Yes
b5-06	0199	01	14	PID limit	0.0 to 100.0	0.1%	100.0	Yes
b5-07	019A	01	15	PID offset adjustment	-100.0 to 100.0	0.1%	0.0	Yes
b5-08	019B	01	16	PID primary delay time constant	0.00 to 10.00	0.01 s	0.00	Yes
b5-09	01A7	---	---	PID output characteristic selection	0, 1	1	0	No
b5-10	01A8	---	---	PID output gain	0.0 to 25.0	0.1	1.0	No
b5-11	01A9	---	---	PID output reverse selection	0, 1	1	0	No
b5-12	01AF	---	---	Feedback loss detection selection	0 to 2	1	0	No
b5-13	01B0	---	---	Feedback loss detection level	0 to 100	1%	0	No
b5-14	01B1	---	---	Feedback loss detection time	0.0 to 25.0	0.1 s	1.00	No

Con-stant	Regis-ter num-ber (hex)	Class 64 (hex)		Name	Setting range	Setting unit	Default setting	Write during operation
		In-stance	At-tribute					
b6-01	019C	01	17	Dwell frequency at start	0.0 to 400.0	0.1 Hz	0.0	No
b6-02	019D	01	18	Dwell time at start	0.0 to 10.0	0.1 s	0.0	No
b6-03	019E	01	19	Dwell frequency at stop	0.0 to 400.0	0.1 Hz	0.0	No
b6-04	019F	01	1A	Dwell time at stop	0.0 to 10.0	0.1 s	0.0	No
b7-01	01A0	01	1B	Droop control gain	0.0 to 100.0	0.1%	0.0	Yes
b7-02	01A1	01	1C	Droop control delay time	0.03 to 2.00	0.01 s	0.05	Yes
b8-01	01A2	01	1D	Energy-saving gain	0 to 100	1%	80	No
b8-02	01A3	01	1E	Energy-saving frequency	0.0 to 400.0	0.1 Hz	0.0	No
b9-01	01A4	01	1F	Zero-servo gain	0 to 100	1	5	No
b9-02	01A5	01	20	Zero-servo completion width	0 to 16383	1 pulse	10	No

Note When the control mode is changed, the Inverter will revert to default settings. (The open loop vector control default setting is given above.)

■ Tuning Parameters

Con-stant	Regis-ter num-ber (hex)	Class 64 (hex)		Name	Setting range	Setting unit	Default setting	Write during operation
		In-stance	At-tribute					
C1-01	0200	01	21	Acceleration time 1	0.0 to 6000.0 (See note 1.)	0.1 s	10	Yes
C1-02	0201	01	22	Deceleration time 1				Yes
C1-03	0202	01	23	Acceleration time 2				Yes
C1-04	0203	01	24	Deceleration time 2				Yes
C1-05	0204	01	25	Acceleration time 3				No
C1-06	0205	01	26	Deceleration time 3				No
C1-07	0206	01	27	Acceleration time 4				No
C1-08	0207	01	28	Deceleration time 4				No
C1-09	0208	01	29	Emergency stop time				No
C1-10	0209	---	---	Acceleration/deceleration time units				0, 1
C1-11	020A	---	---	Acceleration/deceleration switching frequency	0.0 to 400.0	0.1 Hz	0.0	No
C2-01	020B	01	2A	S-curve characteristic time at acceleration start.	0.0 to 2.50	0.01 s	0.20	No
C2-02	020C	01	2B	S-curve characteristic time at acceleration end.	0.0 to 2.50	0.01 s	0.20	No
C2-03	020D	01	2C	S-curve characteristic time at deceleration start.	0.0 to 2.50	0.01 s	0.20	No
C2-04	020E	01	2D	S-curve characteristic time at deceleration end.	0.0 to 2.50	0.01 s	0.00	No
C3-01	020F	01	2E	Slip compensation gain.	0.0 to 2.5	0.1	1.0 (See note 2.)	Yes
C3-02	0210	01	2F	Slip compensation primary delay time.	0 to 10000	1 ms	200 (See note 2.)	No

Constant	Register number (hex)	Class 64 (hex)		Name	Setting range	Setting unit	Default setting	Write during operation
		Instance	Attribute					
C3-03	0211	01	30	Slip compensation limit.	0 to 250	1%	200	No
C3-04	0212	01	31	Slip compensation during regeneration.	0, 1	1	0	No
C3-05	0242	01	32	Flux Calculation Method	0, 1	1	0	No
C3-06	0243	---	---	Output voltage limiting action selection	0, 1	1	0	No
C4-01	0213	01	33	Torque compensation gain.	0.00 to 2.50	0.01	1.00	Yes
C4-02	0214	01	34	Torque compensation delay time.	0 to 10000	1 ms	20 (See note 2.)	No
C4-03	0244	---	---	Startup torque (forward operation)	0.0 to 200.0	0.1%	0.0	No
C4-04	0245	---	---	Startup torque (reverse operation)	-200.0 to 0.0	0.1%	0.0	No
C4-05	0246	---	---	Startup torque compensation time	0 to 200	1 ms	10	No
C5-01	0215	01	35	ASR Proportional (P) gain 1	0.00 to 300.00	0.01	20.00 (See note 2.)	Yes
C5-02	0216	01	36	ASR Integral (I) time 1	0.000 to 10.000	0.001 s	0.500 (See note 2.)	Yes
C5-03	0217	01	37	ASR Proportional Gain (P) 2	0.00 to 300.00	0.01	20.00 (See note 2.)	Yes
C5-04	0218	01	38	ASR Integral (I) time 2	0.000 to 10.000	0.001 s	0.500 (See note 2.)	Yes
C5-05	0219	01	39	ASR Limit	0.0 to 20.0	0.1%	5.0	No
C5-06	021A	01	3A	ASR Primary delay time	0.000 to 0.500	0.001 s	0.004	No
C5-07	021B	01	3B	ASR Switching frequency	0.0 to 400.0	0.1 Hz	0.0	No
C5-08	0241	01	3C	ASR Integral (I) Limit	0 to 400	1%	400	No
C6-01	021C	01	3D	Carrier frequency upper limit.	2.0 to 15.0 (See note 4.)	0.1 kHz	15.0 (See note 3.)	No
C6-02	021D	01	3E	Carrier frequency lower limit.	0.4 to 15.0	0.1 kHz	15.0 (See note 3.)	No
C6-03	021E	01	3F	Carrier frequency proportional gain.	0 to 99	1	0	No
C7-01	021F	01	40	Hunting prevention selection	0, 1	1	1	No
C7-02	0220	01	41	Hunting prevention gain	0.00 to 2.50	0.01	1.00	No
C8-08	022A	01	42	AFR Gain	0.00 to 10.00	0.01	1.00	No
C8-09	022B	---	---	AFR primary delay time	0 to 2000	1 ms	50	No
C8-30	0240	---	---	Carrier Frequency Selection during Auto-tuning	1 to 2	1	2	No

Note 1. The setting range and setting unit for acceleration/deceleration times will differ according to the setting for C1-10 (the unit for acceleration/deceleration time). If C1-10 is set to 0, the setting range for acceleration/deceleration times is 0.00 to 600.00 (s).

Note 2. When the control mode is changed, the Inverter will revert to default settings. (The open loop vector control default settings are given above.)

Note 3. The default setting of the Inverter will differ depending on its capacity. (The value for the 200-V-class 0.4-kW Inverter is given above.)

Note 4. When the control mode is changed, the Inverter will revert to the setting range. (The open loop vector control setting range is given above.)

■ Reference Parameters

Con-stant	Regis-ter num-ber (hex)	Class 64 (hex)		Name	Setting range	Setting unit	Default setting	Write during operation
		In-stance	At-tribute					
d1-01	0280	01	43	Frequency reference 1	0.00 to max. fre- quency	0.01 Hz (Set using o1- 03.)	6.00	Yes
d1-02	0281	01	44	Frequency reference 2			0.00	Yes
d1-03	0282	01	45	Frequency reference 3			0.00	Yes
d1-04	0283	01	46	Frequency reference 4			0.00	Yes
d1-05	0284	01	47	Frequency reference 5			0.00	Yes
d1-06	0285	01	48	Frequency reference 6			0.00	Yes
d1-07	0286	01	49	Frequency reference 7			0.00	Yes
d1-08	0287	01	4A	Frequency reference 8			0.00	Yes
d1-09	0288	01	4B	Jog frequency reference			6.00	Yes
d2-01	0289	01	4C	Reference frequency upper limit	0.0 to 110.0	0.1%	100.0	No
d2-02	028A	01	4D	Reference frequency lower limit	0.0 to 109.0	0.1%	0.0	No
d3-01	028B	01	4E	Jump frequency 1	0.0 to 400.0	0.1 Hz	0.0	No
d3-02	028C	01	4F	Jump frequency 2			0.0	No
d3-03	028D	01	50	Jump frequency 3			0.0	No
d3-04	028E	01	51	Jump frequency width	0.0 to 20.0	0.1 Hz	1.0	No
d4-01	028F	01	52	Reference frequency hold function selection	0, 1	1	0	No
d4-02	0290	01	53	Trim control level	0 to 100	1%	25	No
d5-01	0291	01	54	Torque control selection	0, 1	1	0	No
d5-02	0292	01	55	Torque reference delay time	0 to 1000	1 ms	0	No
d5-03	0293	01	56	Speed limit selection	1, 2	1	1	No
d5-04	0294	01	57	Speed limit	-120 to 120	1%	0	No
d5-05	0295	01	58	Speed limit bias	0 to 120	1%	10	No
d5-06	0296	01	59	Speed/torque control switching timer.	0 to 1000	1 ms	0	No

■ Motor Constant Parameters

Constant	Register number (hex)	Class 64 (hex)		Name	Setting range	Setting unit	Default setting	Write during operation
		Instance	Attribute					
E1-01	0300	01	5A	Input voltage setting	155 to 255 (155 to 510) (See note 1.)	1 V	200 (400) (See note 1.)	No
E1-02	0300	01	5B	Motor selection	0 to 2	1	0	No
E1-03	0302	01	5C	V/f pattern selection	0 to F	1	F	No
E1-04	0303	01	5D	Maximum frequency (FMAX)	40.0 to 400.0	0.1 Hz	60.0	No
E1-05	0304	01	5E	Maximum voltage (VMAX)	0.0 to 255.0 (0.0 to 510.0) (See note 1.)	0.1 V	200.0 (400.0) (See note 1.)	No
E1-06	0305	01	5F	Maximum voltage frequency (FA)	0.0 to 400.0	0.1 Hz	60.0	No
E1-07	0306	01	60	Intermediate frequency (FB)	0.0 to 400.0	0.1 Hz	3.0 (See note 2.)	No
E1-08	0307	01	61	Intermediate voltage (VC)	0.0 to 255.0 (0.0 to 510.0) (See note 1.)	0.1 V	11.0 (22.0) (See notes 1 and 2.)	No
E1-09	0308	01	62	Minimum frequency (FMIN)	0.0 to 400.0	0.1 Hz	0.5 (See note 2.)	No
E1-10	0309	01	63	Minimum voltage (VMIN)	0.0 to 255.0 (0.0 to 510.0) (See note 1.)	0.1 V	2.0 (4.0) (See notes 1 and 2.)	No
E1-11	030A	01	64	Mid. output frequency B	0.0 to 400.0	0.1 Hz	0.0	No
E1-12	030B	01	65	Mid. output frequency voltage B	0.0 to 255.0 (0.0 to 510.0) (See note 1.)	0.1 V	0.0	No
E1-13	030C	01	66	Base voltage	0.0 to 255.0 (0.0 to 510.0) (See note 1.)	0.1 V	0.0	No
E2-01	030E	01	67	Motor rated current	0.32 to 6.40 (See note 4.)	0.01 A	1.90 (See note 3.)	No
E2-02	030F	01	68	Motor rated slip	0.00 to 20.00	0.01 Hz	2.90 (See note 3.)	No
E2-03	0310	01	69	Motor no-load current	0.00 to 2.90 (See note 5.)	0.01 A	1.20 (See note 3.)	No
E2-04	0311	01	6A	Number of motor poles	2 to 48	1	4	No

Con-stant	Regis-ter num-ber (hex)	Class 64 (hex)		Name	Setting range	Setting unit	Default setting	Write during operation
		In-stance	At-tribute					
E2-05	0312	01	6B	Motor phase-to-phase resistance	0.000 to 65.000	0.001 Ω	9.842 (See note 3.)	No
E2-06	0313	01	6C	Motor leakage inductance	0.0 to 40.0	0.1%	18.2 (See note 3.)	No
E2-07	0314	01	6D	Motor iron-core saturation coefficient 1	0.00 to 0.50	0.01	0.50	No
E2-08	0315	01	6E	Motor iron-core saturation coefficient 2	0.00 to 0.75	0.01	0.75	No
E2-09	0316	01	6F	Mechanical loss	0.0 to 10.0	0.1%	0.0	No
E2-10	0325	---	----	Torque compensation motor iron loss	0 to 65535	1 W	14 (See note 3.)	No
E3-01	0317	---	----	Select control method of motor 2	0 to 3	1	2	No
E4-01	0318	---	----	Motor 2 maximum frequency	40.0 to 400.0	0.1 Hz	60.0	No
E4-02	0319	---	----	Motor 2 maximum voltage	0.0 to 255.0 (0.0 to 510.0) (See note 1.)	0.1 V	200.0 (400.0) (See note 1.)	No
E4-03	031A	---	----	Motor 2 maximum voltage frequency	0.0 to 400.0	0.1 Hz	60.0	No
E4-04	031B	---	----	Motor 2 intermediate frequency	0.0 to 400.0	0.1 Hz	3.0 (See note 2.)	No
E4-05	031C	---	----	Motor 2 intermediate voltage	0.0 to 255.0 (0.0 to 510.0) (See note 1.)	0.1 V	11.0 (22.0) (See notes 1 and 2.)	No
E4-06	031D	---	----	Motor 2 minimum frequency	0.0 to 400.0	0.1 Hz	0.5 (See note 2.)	No
E4-07	031E	---	----	Motor 2 minimum voltage	0.0 to 255.0 (0.0 to 510.0) (See note 1.)	0.1 V	2.0 (4.0) (See notes 1 and 2.)	No
E5-01	031F	---	----	Motor 2 rated current	0.32 to 6.40 (See note 4.)	0.01 A	1.90 (See note 3.)	No
E5-02	0320	---	----	Motor 2 rated slip	0.00 to 20.00	0.01 Hz	2.90 (See note 3.)	No
E5-03	0321	---	----	Motor 2 no-load current	0.00 to 2.90 (See note 5.)	0.01 A	1.20 (See note 3.)	No
E5-04	0322	---	----	Motor 2 number of motor poles	2 to 48	1 pole	4	No
E5-05	0323	---	----	Motor 2 phase-to-phase resistance	0.000 to 65.000	0.001 Ω	9.842 (See note 3.)	No
E5-06	0324	---	----	Motor 2 leakage inductance	0.0 to 40.0	0.1%	18.2 (See note 3.)	No

- Note 1.** Values in parentheses are for 400-V-class Inverters.
- Note 2.** When the control mode is changed, the Inverter will revert to default settings. (The open loop vector control default settings are given above.)
- Note 3.** The default setting depends upon the type of Inverter. The value for a 200-V-class 0.4-kW Inverter is given above.
- Note 4.** The setting range is 10% to 200% of the Inverter's rated output current. The values for a 200-V-class 0.4-kW Inverter are given above.
- Note 5.** The setting range is 0.00 to (motor's rated current -0.1 A). The value for a 200-V-class 0.4-kW Inverter is given above.

■ Option Parameters

Constant	Register number (hex)	Class 64 (hex)		Name	Setting range	Setting unit	Default setting	Write during operation
		In-stance	At-tribute					
F1-01	0380	01	70	Number of PG pulses	0 to 60000	1 p/r	1000	No
F1-02	0381	01	71	PG disconnection stopping method (PGO)	0 to 3	1	1	No
F1-03	0382	01	72	PG overspeed stopping method	0 to 3	1	1	No
F1-04	0383	01	73	PG speed deviation stopping method	0 to 3	1	3	No
F1-05	0384	01	74	PG rotation setting	0, 1	1	0	No
F1-06	0385	01	75	PG output ratio	0 to 132	1	1	No
F1-07	0386	01	76	Selecting integral control during accel/ decel.	0, 1	1	0	No
F1-08	0387	01	77	Overspeed (OS) detection level.	0 to 120	1%	115	No
F1-09	0388	01	78	Overspeed (OS) detection time	0.0 to 2.0	0.1 s	0.0 (See note 1.)	No
F1-10	0389	01	79	PG speed deviation detection level (DEV)	0 to 50	1%	10	No
F1-11	038A	01	7A	PG speed deviation detection time (DEV)	0.0 to 10.0	0.1 s	0.5	No
F1-12	038B	01	7B	Number of PG gear teeth 1	0 to 1000	1	0	No
F1-13	038C	01	7C	Number of PG gear teeth 2	0 to 1000	1	0	No
F1-14	0397	01	7D	PG disconnection detection time	0.0 to 10.0	0.1 s	2.0	No
F2-01	038D	---	---	Analog Reference Card selection	0, 1	1	0	No
F3-01	038E	---	---	Digital Reference Card input selection	0 to 7	1	0	No
F4-01	038F	---	---	Channel 1 output monitor selection	1 to 38 (See note 2.)	1	2	No
F4-02	0390	---	---	Channel 1 gain	0.00 to 2.50	0.01	1.00	Yes
F4-03	0391	---	---	Channel 2 output monitor selection	1 to 38 (See note 2.)	1	3	No
F4-04	0392	---	---	Channel 2 gain	0.00 to 2.50	0.01	0.50	Yes
F4-05	03A0	---	---	Channel 1 bias	-10.0 to 10.0	0.1%	0.0	Yes
F4-06	03A1	---	---	Channel 2 bias	-10.0 to 10.0	0.1%	0.0	Yes
F5-01	0393	---	---	Not used.	---	---	0	---
F5-02	0394	---	---	Not used.	---	---	1	---

Con-stant	Regis-ter num-ber (hex)	Class 64 (hex)		Name	Setting range	Setting unit	Default setting	Write during operation
		In-stance	At-tribute					
F6-01	0395	---	---	Not used.	---	---	0	---
F7-01	0396	---	---	Output pulse multiple selection	0 to 4	1	1	No
F8-01	0398	---	---	Operation selection (E-15)	0 to 3	1	1	No
F9-01	0399	---	---	Communications external fault input selection	0, 1	1	0	No
F9-02	039A	---	---	Communications external fault input detection selection	0, 1	1	0	No
F9-03	039B	---	---	Communications external fault input operation selection	0 to 3	1	1	No
F9-04	039C	---	---	Not used.	---	---	0	---
F9-05	039E	---	---	Torque reference/Torque limit selection from communications	0, 1	1	1	No
F9-06	039F	---	---	DeviceNet operation selection	0 to 3	1	1	No

Note 1. When the control mode is changed, the Inverter will revert to default settings. (The open loop vector control default settings are given above.)

Note 2. Within the setting range (1 to 38), 4, 10, 11, 12, 13, 14, 25, 28, 34, and 35 cannot be set, and 29 to 31 are not used.

■ External Terminal Function Parameters

Con-stant	Regis-ter num-ber (hex)	Class 64 (hex)		Name	Setting range	Setting unit	Default setting	Write during operation
		In-stance	At-tribute					
H1-01	0400	01	7E	Multi-function input 1: terminal 3 selection	0 to 77	1	24	No
H1-02	0401	01	7F	Multi-function input 2: terminal 4 selection			14	No
H1-03	0402	01	80	Multi-function input 3: terminal 5 selection			3 (0) (See note 1.)	No
H1-04	0403	01	81	Multi-function input 4: terminal 6 selection			4 (3) (See note 1.)	No
H1-05	0404	01	82	Multi-function input 5: terminal 7 selection			6 (4) (See note 1.)	No
H1-06	0405	01	83	Multi-function input 6: terminal 8 selection			8 (6) (See note 1.)	No
H2-01	0406	01	84	Multi-function contact output: terminal 9 to 10.	0 to 37	1	0	No
H2-02	0407	01	85	Multi-function output 1: terminal 25.			1	No
H2-03	0408	01	86	Multi-function output 2: terminal 26.			2	No
H3-01	0409	01	87	Signal selection: terminal 13 (Voltage)	0, 1	1	0	No
H3-02	040A	01	88	Frequency reference (voltage) gain: terminal 13	0.0 to 1000.0	0.1%	100.0	Yes
H3-03	040B	01	89	Frequency reference (voltage) bias: terminal 13	-100.0 to 100.0	0.1%	0.0	Yes
H3-04	040C	01	8A	Multi-function analog input signal selection: terminal 16	0, 1	1	0	No
H3-05	040D	01	8B	Multi-function analog input signal selection: terminal 16	0 to 1F	1	1F	No

Constant	Register number (hex)	Class 64 (hex)		Name	Setting range	Setting unit	Default setting	Write during operation
		Instance	Attribute					
H3-06	040E	01	8C	Multi-function analog input signal gain: terminal 16	0.0 to 1000.0	0.1%	100.0	Yes
H3-07	040F	01	8D	Multi-function analog input signal bias: terminal 16	-100.0 to 100.0	0.1%	0.0	Yes
H3-08	0410	01	8E	Frequency reference (current) signal selection: terminal 14	0 to 2	1	2	No
H3-09	0411	01	8F	Frequency reference (current) selection: terminal 14	0 to 1F	1	1F	No
H3-10	0412	01	90	Frequency reference (current) gain: terminal 14	0.0 to 1000.0	0.1%	100.0	Yes
H3-11	0413	01	91	Frequency reference (current) bias: terminal 14	-100.0 to 100.0	0.1%	0.0	Yes
H3-12	0414	01	92	Analog input filter time constant	0.00 to 2.00	0.01 s	0.00	No
H4-01	0415	01	93	Multi-function analog output 1 selection: terminal 21	1 to 38 (See note 2.)	1	2	No
H4-02	0416	01	94	Multi-function analog output 1 gain terminal 21	0.00 to 2.50	0.01	1.00	Yes
H4-03	0417	01	95	Multi-function analog output 1 bias terminal 21	-10.0 to 10.0	0.1%	0.0	Yes
H4-04	0418	01	96	Multi-function analog output 2 selection: terminal 23	1 to 38 (See note 2.)	1	3	No
H4-05	0419	01	97	Multi-function analog output 2 gain terminal 23	0.00 to 2.50	0.01	0.50	Yes
H4-06	041A	01	98	Multi-function analog output 2 bias terminal 23	-10.0 to 10.0	0.1%	0.0	Yes
H4-07	041B	01	99	Multi-function analog output signal level selection	0, 1	1	0	No
H5-01	041C	---	---	Not used.	---	---	1F	---
H5-02	041D	---	---	Not used.	---	---	3	---
H5-03	041E	---	---	Not used.	---	---	0	---
H5-04	041F	---	---	Not used.	---	---	3	---
H5-05	0420	---	---	Not used.	---	---	1	---

Note 1. The values in parentheses indicate initial values when initialized in 3-wire sequence.

Note 2. Within the setting range (1 to 38), 4, 10, 11, 12, 13, 14, 25, 28, 34, and 35 cannot be set, and 29 to 31 are not used.

■ Protective Function Parameters

Constant	Register number (hex)	Class 64 (hex)		Name	Setting range	Setting unit	Default setting	Write during operation
		Instance	Attribute					
L1-01	0480	01	9A	Motor protection selection	0, 1	1	1	No
L1-02	0481	01	9B	Motor protection time constant	0.1 to 5.0	0.1 min	1.0	No
L2-01	0482	04	9C	Momentary power loss selection	0 to 2	1	0	No
L2-02	0483	01	9D	Momentary power loss ridethru	0.0 to 2.0	0.1 s	0.7 (See note 2.)	No
L2-03	0484	01	9E	Minimum baseblock time (BB)	0.1 to 5.0	0.1 s	0.5 (See note 2.)	No

Con-stant	Regis-ter num-ber (hex)	Class 64 (hex)		Name	Setting range	Setting unit	Default setting	Write during operation
		In-stance	At-tribute					
L2-04	0485	01	9F	Voltage restart time	0.0 to 5.0	0.1 s	0.3	No
L2-05	0486	01	A0	Under voltage detection level (UV)	150 to 210 (150 to 420) (See note 1.)	1 V	190 (380) (See note 1.)	No
L2-06	0487	01	A1	Not used.	---	---	0.0	---
L3-01	0488	01	A2	Stall prevention during acceleration	0 to 2	1	1	No
L3-02	0489	01	A3	Stall prevention level during acceleration	0 to 200	1%	150	No
L3-03	048A	01	A4	Stall prevention limit during acceleration	0 to 100	1%	50	No
L3-04	048B	01	A5	Stall prevention during deceleration	0 to 3	1	1	No
L3-05	048C	01	A6	Stall prevention during run	0 to 2	1	1	No
L3-06	048D	01	A7	Stall prevention level during run	30 to 200	1%	160	No
L4-01	0490	01	A8	Frequency detection level	0.0 to 400.0	0.1 Hz	0.0	No
L4-02	0491	01	A9	Frequency detection width	0.0 to 20.0	0.1 Hz	2.0	No
L4-03	0492	01	AA	Frequency detection level (+/-)	-400.0 to 400.0	0.1 Hz	0.0	No
L4-04	0493	01	AB	Frequency detection width (+/-)	0.0 to 20.0	0.1 Hz	2.0	No
L4-05	0494	01	AC	Operation when frequency reference is lost	0, 1	1	0	No
L5-01	0495	01	AD	Number of auto restart attempts	0 to 10	1	0	No
L5-02	0496	01	AE	Auto restart operation selection	0, 1	1	0	No
L6-01	0498	01	AF	Torque detection selection 1	0 to 4	1	0	No
L6-02	0499	01	B0	Torque detection level 1	0 to 300	1%	150	No
L6-03	049A	01	B1	Torque detection time 1	0.0 to 10.0	0.1 s	0.1	No
L6-04	049B	01	B2	Torque detection selection 2	0 to 4	1	0	No
L6-05	049C	01	B3	Torque detection level 2	0 to 300	1%	150	No
L6-06	049D	01	B4	Torque detection time 2	0.0 to 10.0	0.1 s	0.1	No
L7-01	049E	01	B5	Forward torque limit	0 to 300	1%	200	No
L7-02	049F	01	B6	Reverse torque limit				No
L7-03	04A0	01	B7	Forward regenerative torque limit				No
L7-04	04A1	01	B8	Reverse regenerative torque limit				No
L8-01	04A4	01	B9	DB resistor protection	0, 1	1	0	No
L8-02	04A5	01	BA	Inverter overheat detection pre-alarm level	50 to 130	1°C	95	No
L8-03	04A6	01	BB	Operation after Inverter overheat pre-alarm	0 to 3	1	3	No

Constant	Register number (hex)	Class 64 (hex)		Name	Setting range	Setting unit	Default setting	Write during operation
		Instance	Attribute					
L8-05	04A8	01	BC	Input open-phase protection selection	0, 1	1	0	No
L8-07	04AA	01	BD	Output open-phase protection selection	0, 1	1	0	No
L8-10	04AD	01	BE	Ground fault protection operation selection	0, 1	1	1	No
L8-17	04B4	---	---	Low-speed carrier frequency reduction selection (2)	0 to 3	1	1	No
L8-19	04B6	---	---	Low-speed Inverter overload (OL2) characteristic selection	0, 1	1	0	No

Note 1. Values in parentheses are for 400-V-class Inverters.

Note 2. The default setting depends upon the type of Inverter. The value for a 200-V-class 0.4-kW Inverter is given above.

■ Operator Parameters

Constant	Register number (hex)	Class 64 (hex)		Name	Setting range	Setting unit	Default setting	Write during operation
		Instance	Attribute					
o1-01	0500	01	BF	Monitor selection	4 to 38	1	6	Yes
o1-02	0501	01	C0	Monitor selection after power-on	1 to 4	1	1	Yes
o1-03	0502	01	C1	Frequency reference setting and display units	0 to 39999	1	0	No
o1-04	0503	01	C2	V/f pattern setting units	0, 1	1	0	No
o1-05	0504	01	C3	Not used.	---	---	0	---
o2-01	0505	01	C4	Local/Remote Key	0, 1	1	1	No
o2-02	0506	01	C5	Stop Key	0, 1	1	1	No
o2-03	0507	---	---	User constant initial values	0 to 2	1	0	No
o2-04	0508	01	C6	Inverter capacity selection	0 to FF (See note.)	1	0 (See note.)	No
o2-05	0509	01	C7	Frequency reference setting method	0, 1	1	0	No
o2-06	050A	01	C8	Operation selection when Digital Operator is disconnected	0, 1	1	0	No
o2-07	050B	---	---	Cumulative operation time setting	0 to 65535	1 hr	0	No
o2-08	050C	---	---	Cumulative operation time selection	0, 1	1	0	No
o2-09	050D	01	C9	Factory use	---	---	1	---

Note The default setting depends upon the type of Inverter. The value for a 200-V-class 0.4-kW Inverter is given above.

Revision History

A manual revision code appears as a suffix to the catalog number on the front cover of the manual.

Cat. No. I539-E1-03

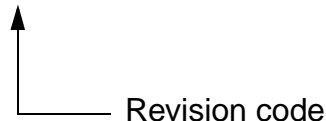

The following table outlines the changes made to the manual during each revision. Page numbers refer to the previous version.

Revision code	Date	Revised content
01	May 2003	Original production
02	March 2005	<p>Changes were made throughout the manual to add information, and make minor corrections. These changes included adding information for new models (e.g., -V1 suffix), changing CS1/CJ1 to CS/CJ and PC to PLC. Precautionary and warranty and liability information was also added to the beginning of the manual. The following changes were also made.</p> <p>Pages 1-10 and 8-3: Changed reference.</p> <p>Pages 2-5 and 10-35: Changed note.</p> <p>Page 2-11: Changed catalog number form W328 to W382.</p> <p>Page 3-6: Added precaution.</p> <p>Page 3-17: Added information on multi-drop connections with Thick Cables.</p> <p>Page 5-28: Added note and diagrams.</p> <p>Page 6-4: Added setting range for word S+2.</p> <p>Page 6-6: Changed bit numbers for Network Communication Error Flag.</p> <p>Page 6-16: Added information to Attribute 65.</p> <p>Pages 6-17, 7-11, 7-59, 10-20, 10-35, and 10-64: Added note.</p> <p>Pages 6-19 and 10-20: Added information to table.</p> <p>Page 7-14: Corrected values in note 3.</p> <p>Page 7-15: Changed information in table.</p> <p>Page 8-6: Added 3G3PV to information on ENTER command.</p> <p>Page 8-8: Changed information on special remote I/O in tables.</p> <p>Pages 10-2 and 10-3: Added baud rate information.</p> <p>Page 10-4: Added information on restarting communications.</p> <p>Pages 10-8, 10-9, 10-18, 10-19, 10-25, 10-59, 10-61, 10-64, 10-95, 10-96, 10-98, and 10-99: Added note references to table.</p> <p>Pages 10-12 and 10-13: Added Yes to Write column for Attribute 66.</p>
03	May 2008	<p>Page 3-13: Corrected torque values.</p> <p>Page 3-25: Corrected standard numbers.</p> <p>Page 10-32: Corrected "W" to "kW" for attribute 37.</p> <p>Page 10-33: Corrected bit 11 to "UL3."</p> <p>Page 10-35: Changed setting range or constant n002 and added note under table.</p>

Revision History

OMRON Corporation

Industrial Automation Company

Control Devices Division H.Q.**Motion Control Department**

Shiokoji Horikawa, Shimogyo-ku,

Kyoto, 600-8530 Japan

Tel: (81) 75-344-7173/Fax: (81) 75-344-7149

2-2-1 Nishikusatsu, Kusatsu-shi,

Shiga, 525-0035 Japan

Tel: (81) 77-565-5223/Fax: (81) 77-565-5568

Regional Headquarters**OMRON EUROPE B.V.**

Wegalaan 67-69-2132 JD Hoofddorp

The Netherlands

Tel: (31)2356-81-300/Fax: (31)2356-81-388

OMRON Industrial Automation Global: www.ia.omron.com**OMRON ELECTRONICS LLC**

One Commerce Drive Schaumburg,

IL 60173-5302 U.S.A.

Tel: (1) 847-843-7900/Fax: (1) 847-843-7787

OMRON ASIA PACIFIC PTE. LTD.

No. 438A Alexandra Road # 05-05/08 (Lobby 2),

Alexandra Technopark, Singapore 119967

Tel: (65) 6835-3011/Fax: (65) 6835-2711

OMRON (CHINA) CO., LTD.

Room 2211, Bank of China Tower,

200 Yin Cheng Zhong Road,

PuDong New Area, Shanghai, 200120, China

Tel: (86) 21-5037-2222/Fax: (86) 21-5037-2200

Authorized Distributor:

© OMRON Corporation 2003 All Rights Reserved.
In the interest of product improvement,
specifications are subject to change without notice.

Cat. No. I539-E1-03

Printed in Japan

0508