

SETUP MANUAL

3G3IV-PLKEB2□□□/4□□□

Braking Resistor Units

3G3IV-PCDBR2□□□B/4□□□B

Braking Units

Thank you for choosing an OMRON Braking Resistor Unit and Braking Unit. Proper use and handling of the product will ensure proper product performance, will lengthen product life, and may prevent possible accidents. Please read this manual thoroughly and handle and operate the product with care. Please keep this manual in a safe place.

The 3G3IV-PLKEB2□□□/4□□□ Braking Resistor Units and the 3G3IV-PCDBR2□□□B/4□□□B Braking Units are designed to increase the braking capabilities of a SYSDRIVE system when using a general-purpose SYSDRIVE Inverter to drive a 3-phase motor. The Braking Resistor Unit works by consuming regenerative energy from the motor when decelerating.

1. To ensure safe and proper use of the OMRON Inverters, please read this SETUP MANUAL (Cat. No. I526-E1) to gain sufficient knowledge of the devices, safety information, and precautions before actual use.
2. The products are illustrated without covers and shieldings for closer look in this SETUP MANUAL. For actual use of the products, make sure to use the covers and shieldings as specified.
3. This SETUP MANUAL and other related manuals are to be delivered to the actual end users of the products.
4. Please keep this manual close at hand for future reference.
5. If the product has been left unused for a long time, please inquire at our sales representative.

NOTICE

1. This manual describes the functions of the product and relations with other products. You should assume that anything not described in this manual is not possible. If you intend on using the product in devices or systems relating to atomic power control, transportation, combustion devices, medical equipment, amusement rides, safety devices, or in other applications directly related to human life, allow sufficient leeway in rating and performance, install fail-safe systems and other safety measures, confirm specifications, and consult with your OMRON representative in advance.
2. Although care has been given in documenting the product, please contact your OMRON representative if you have any suggestions on improving this manual.
3. The product contains potentially dangerous parts under the covers. Do not use the product with the covers open. Doing so may result in injury or death and may damage the product. Never attempt to repair or disassemble the product.
4. We recommend that you add the following precautions to any instruction manuals you prepare for the system into which the product is being installed.
 - Precautions on the dangers of high-voltage equipment.
 - Precautions on touching the terminals of the product.
5. Specifications and functions may be changed without notice in order to improve product performance.

Items to Check Before Unpacking

Check the following items before removing the product from the package:

- Has the correct product been delivered (i.e., the correct model number and specifications)?
- Has the product been damaged in shipping?
- Are any screws or bolts loose?

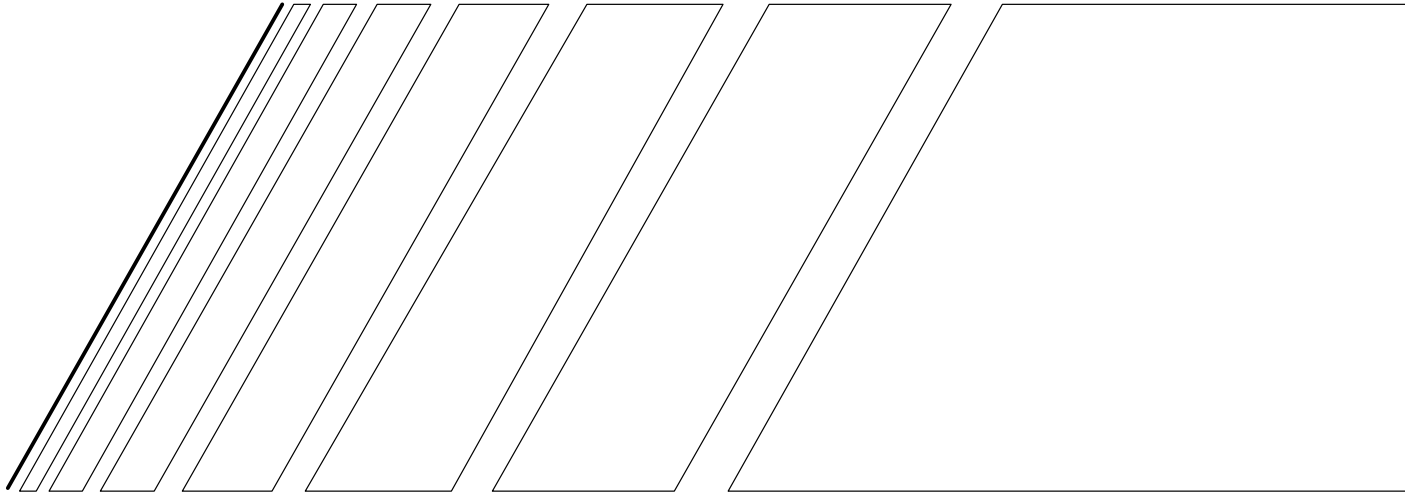

SETUP MANUAL

3G3IV-PLKEB2□□□/4□□□

Braking Resistor Units

3G3IV-PCDBR2□□□B/4□□□B

Braking Units

Notice:

OMRON products are manufactured for use according to proper procedures by a qualified operator and only for the purposes described in this manual.

The following conventions are used to indicate and classify precautions in this manual. Always heed the information provided with them. Failure to heed precautions can result in injury to people or damage to the product.

 **WARNING** Indicates information that, if not heeded, could possibly result in loss of life or serious injury. Additionally, there may be severe property damage.

 **Caution** Indicates information that, if not heeded, could result in relatively serious or minor injury, damage to the product, or faulty operation.

OMRON Product References

OMRON products are capitalized in this manual. The word “Unit” is also capitalized when it refers to an OMRON product, regardless of whether or not it appears in the proper name of the product.

Visual Aids

The following headings appear in the left column of the manual to help you locate different types of information.

Note Indicates information of particular interest for efficient and convenient operation of the product.

© OMRON, 1998

All rights reserved. No part of this publication may be reproduced, stored in a retrieval system, or transmitted, in any form, or by any means, mechanical, electronic, photocopying, recording, or otherwise, without the prior written permission of OMRON.

No patent liability is assumed with respect to the use of the information contained herein. Moreover, because OMRON is constantly striving to improve its high-quality products, the information contained in this manual is subject to change without notice. Every precaution has been taken in the preparation of this manual. Nevertheless, OMRON assumes no responsibility for errors or omissions. Neither is any liability assumed for damages resulting from the use of the information contained in this publication.

Product Confirmation

-  **Caution** Do not install or operate a Braking Unit or Braking Resistor Unit that is damaged or is missing parts. Doing so may result in injury.

Transportation and Installation

-  **Caution** Do not hold the Unit by the front cover when carrying it. Always hold the bottom of the case. If the Unit is held by the cover, the main body of the Unit may fall, possibly resulting in injury.

-  **Caution** Do not install a Unit near flammable objects. The Unit generates heat and may cause fire if installed near flammable objects.

-  **Caution** Install cooling fans or other means of cooling when installing more than one Unit in the same enclosure to ensure that the temperature of the air entering a Braking Resistor Unit or Braking Unit is 40 °C maximum. Fire or other accidents may be caused by overheating.

-  **Caution** Do not conduct withstand voltage test on a Braking Resistor Unit or Braking Unit. Doing so may damage semiconductor elements inside the Units.

Wiring

-  **WARNING** Always confirm that the input power supply is OFF before wiring a Braking Resistor Unit or Braking Unit. Wiring a Unit while the power is being supplied may result in electric shock or fire.

-  **WARNING** The Braking Resistor Unit and Braking Unit have high-voltage terminals, which can be extremely dangerous if touched. Do not touch the terminals. Touching these terminals may result in electric shock.

-  **WARNING** Allow wiring work to be performed only by a qualified electrician. Improper wiring may result in electric shock or fire.

-  **WARNING** Always ground the ground terminal properly to a ground resistance of 100 Ω maximum for 200 V-class systems and to a ground resistance of 10 Ω maximum for 400 V-class systems.

-  **Caution** The thermal relays on the Braking Resistor Units and Braking Units must be wired to circuits that will stop Inverter operation. Always check the wiring and check operation after completing wiring work. (The user is responsible for wiring.) Fire may result if these relays are not connected properly.

-  **Caution** Do not allow physical stress to be applied to the wiring. Physical stress on the wiring can cause broken wires or contact faults, possibly resulting in fire.

 **Caution** Confirm that the power supply voltage is the same as the rated voltage of the Braking Resistor Units and Braking Units. (Check the setting of the power supply selection connector on the Braking Units.) Incorrect power supply voltages may result in injury or fire.

 **Caution** Tighten all terminals to the specified tightening torque. Improperly tightened terminals may result in fire.

Operation

 **WARNING** Always attach the front cover before turning ON the power supply and do not remove the front cover while power is being supplied. Operating without the front cover in place may result in electric shock.

 **Caution** Do not touch the cooling fins and discharge resistors, which become very hot. Touching the cooling fins or discharge resistors may result in burns.

 **Caution** Although the Braking Resistor Unit and Braking Unit are set to the normal settings at the factory, you must check the settings according to the contents of the manual and change any settings as required by the system before starting operation. Operating with incorrect settings may result in burns or fire.

Inspection and Maintenance

 **WARNING** The Braking Resistor Unit and Braking Unit have high-voltage terminals, which can be extremely dangerous if touched. Do not touch the terminals. Touching these terminals may result in electric shock.

 **WARNING** Always keep the protective covers attached while power is being supplied and use a MCCB to interrupt the power supply before removing a protective cover. Having the protective cover removed while power is supplied may result in electric shock.

 **WARNING** After turning OFF the main power supply, always confirm that the charge indicator turns OFF before performing any inspection or maintenance work. The capacitors will retain a charge and can cause electric shock if not completely discharged.

 **WARNING** Allow maintenance, inspections, and part replacements to be performed only by specified personnel. Remove all metal objects (watches, wrist bands, etc.) before starting work and use insulated tools. Improper or unqualified work may result in electric shock.

 **WARNING** Do not change wiring, attach a connector, or remove a connector while power is being supplied. Doing so may result in electric shock.

 **Caution** Internal boards contain CMOS ICs, which must be handled with care. Do not touch these boards or ICs directly with your bare hands. Static electricity from your hands may destroy the ICs.

 **Caution**

Periodically check the operation of the circuits that stop Inverter operation with the thermal relays on the Braking Resistor Units and Braking Units. Functional failure (e.g., malfunction of the thermal relays, broken wiring, contact faults, etc.) may result in fire.

Other

 **WARNING**

Never attempt to modify a Unit in any way. Doing so may result in electric shock or injury.

Read and Understand this Manual

Please read and understand this manual before using the product. Please consult your OMRON representative if you have any questions or comments.

Warranty and Limitations of Liability

WARRANTY

OMRON's exclusive warranty is that the products are free from defects in materials and workmanship for a period of one year (or other period if specified) from date of sale by OMRON.

OMRON MAKES NO WARRANTY OR REPRESENTATION, EXPRESS OR IMPLIED, REGARDING NON-INFRINGEMENT, MERCHANTABILITY, OR FITNESS FOR PARTICULAR PURPOSE OF THE PRODUCTS. ANY BUYER OR USER ACKNOWLEDGES THAT THE BUYER OR USER ALONE HAS DETERMINED THAT THE PRODUCTS WILL SUITABLY MEET THE REQUIREMENTS OF THEIR INTENDED USE. OMRON DISCLAIMS ALL OTHER WARRANTIES, EXPRESS OR IMPLIED.

LIMITATIONS OF LIABILITY

OMRON SHALL NOT BE RESPONSIBLE FOR SPECIAL, INDIRECT, OR CONSEQUENTIAL DAMAGES, LOSS OF PROFITS OR COMMERCIAL LOSS IN ANY WAY CONNECTED WITH THE PRODUCTS, WHETHER SUCH CLAIM IS BASED ON CONTRACT, WARRANTY, NEGLIGENCE, OR STRICT LIABILITY.

In no event shall the responsibility of OMRON for any act exceed the individual price of the product on which liability is asserted.

IN NO EVENT SHALL OMRON BE RESPONSIBLE FOR WARRANTY, REPAIR, OR OTHER CLAIMS REGARDING THE PRODUCTS UNLESS OMRON'S ANALYSIS CONFIRMS THAT THE PRODUCTS WERE PROPERLY HANDLED, STORED, INSTALLED, AND MAINTAINED AND NOT SUBJECT TO CONTAMINATION, ABUSE, MISUSE, OR INAPPROPRIATE MODIFICATION OR REPAIR.

Application Considerations

SUITABILITY FOR USE

OMRON shall not be responsible for conformity with any standards, codes, or regulations that apply to the combination of products in the customer's application or use of the products.

At the customer's request, OMRON will provide applicable third party certification documents identifying ratings and limitations of use that apply to the products. This information by itself is not sufficient for a complete determination of the suitability of the products in combination with the end product, machine, system, or other application or use.

The following are some examples of applications for which particular attention must be given. This is not intended to be an exhaustive list of all possible uses of the products, nor is it intended to imply that the uses listed may be suitable for the products:

- Outdoor use, uses involving potential chemical contamination or electrical interference, or conditions or uses not described in this manual.
- Nuclear energy control systems, combustion systems, railroad systems, aviation systems, medical equipment, amusement machines, vehicles, safety equipment, and installations subject to separate industry or government regulations.
- Systems, machines, and equipment that could present a risk to life or property.

Please know and observe all prohibitions of use applicable to the products.

NEVER USE THE PRODUCTS FOR AN APPLICATION INVOLVING SERIOUS RISK TO LIFE OR PROPERTY WITHOUT ENSURING THAT THE SYSTEM AS A WHOLE HAS BEEN DESIGNED TO ADDRESS THE RISKS, AND THAT THE OMRON PRODUCTS ARE PROPERLY RATED AND INSTALLED FOR THE INTENDED USE WITHIN THE OVERALL EQUIPMENT OR SYSTEM.

PROGRAMMABLE PRODUCTS

OMRON shall not be responsible for the user's programming of a programmable product, or any consequence thereof.

Disclaimers

CHANGE IN SPECIFICATIONS

Product specifications and accessories may be changed at any time based on improvements and other reasons.

It is our practice to change model numbers when published ratings or features are changed, or when significant construction changes are made. However, some specifications of the products may be changed without any notice. When in doubt, special model numbers may be assigned to fix or establish key specifications for your application on your request. Please consult with your OMRON representative at any time to confirm actual specifications of purchased products.

DIMENSIONS AND WEIGHTS

Dimensions and weights are nominal and are not to be used for manufacturing purposes, even when tolerances are shown.

PERFORMANCE DATA

Performance data given in this manual is provided as a guide for the user in determining suitability and does not constitute a warranty. It may represent the result of OMRON's test conditions, and the users must correlate it to actual application requirements. Actual performance is subject to the OMRON Warranty and Limitations of Liability.

ERRORS AND OMISSIONS

The information in this manual has been carefully checked and is believed to be accurate; however, no responsibility is assumed for clerical, typographical, or proofreading errors, or omissions.

Table of Contents

Chapter 1. Models	1-1
1-1 Standard Models	1-2
Chapter 2. Installation	2-1
2-1 Installation Site Precautions	2-2
2-2 Braking Unit Mounting Dimensions	2-2
2-3 Braking Resistor Unit Mounting Dimensions	2-4
Chapter 3. Braking Unit Covers	3-1
3-1 Removing and Replacing the Terminal Cover	3-2
3-2 Removing and Replacing the Inner Cover	3-2
Chapter 4. Nomenclature	4-1
4-1 Braking Unit	4-2
4-2 Braking Resistor Unit	4-5
Chapter 5. Wiring	5-1
5-1 Wiring Lead-in Method	5-2
5-2 Separation from Signal Lines	5-2
5-3 Wiring Distance	5-2
5-4 Grounding	5-2
5-5 Wiring between Units	5-2
Chapter 6. Settings	6-1
6-1 Power Supply Selection Connector	6-2
6-2 Master/Slave Selection Connector	6-3
Chapter 7. Connecting Braking Units in Parallel	7-1
Chapter 8. Operation	8-1
Chapter 9. Troubleshooting	9-1
Chapter 10. Specifications	10-1
10-1 Braking Unit–Braking Resistor Unit Application Tables	10-2
10-2 Braking Unit Specifications	10-4
10-3 Braking Resistor Unit Specifications	10-6

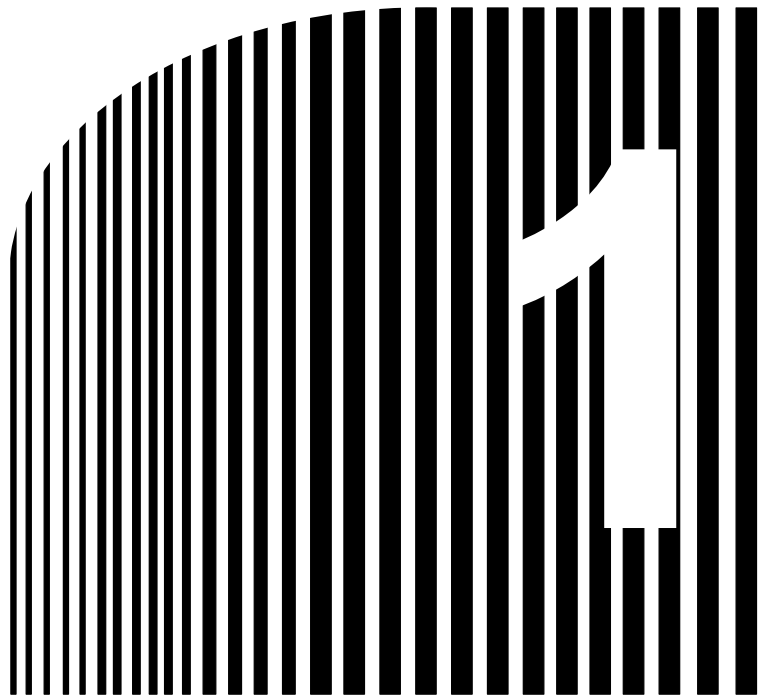

Chapter 1

• Models •

1-1 Standard Models

1-1 Standard Models

■ Braking Units

Specification	Model	Specification	Model
200 VAC	3G3IV-PCDBR2015B	400 VAC	3G3IV-PCDBR4030B
	3G3IV-PCDBR2022B		3G3IV-PCDBR4045B
	3G3IV-PCDBR2110B		3G3IV-PCDBR4220B

■ Breaking Resistor Units

Specification	Model	Specification	Model
200 VAC	3G3IV-PLKEB20P7	400 VAC	3G3IV-PLKEB40P7
	3G3IV-PLKEB21P5		3G3IV-PLKEB41P5
	3G3IV-PLKEB22P2		3G3IV-PLKEB42P2
	3G3IV-PLKEB23P7		3G3IV-PLKEB43P7
	3G3IV-PLKEB25P5		3G3IV-PLKEB45P5
	3G3IV-PLKEB27P5		3G3IV-PLKEB47P5
	3G3IV-PLKEB2011		3G3IV-PLKEB4011
	3G3IV-PLKEB2015		3G3IV-PLKEB4015
	3G3IV-PLKEB2018		3G3IV-PLKEB4018
	3G3IV-PLKEB2022		3G3IV-PLKEB4022
	---		3G3IV-PLKEB4030
	3G3IV-PLKEB4037		
	3G3IV-PLKEB4045		

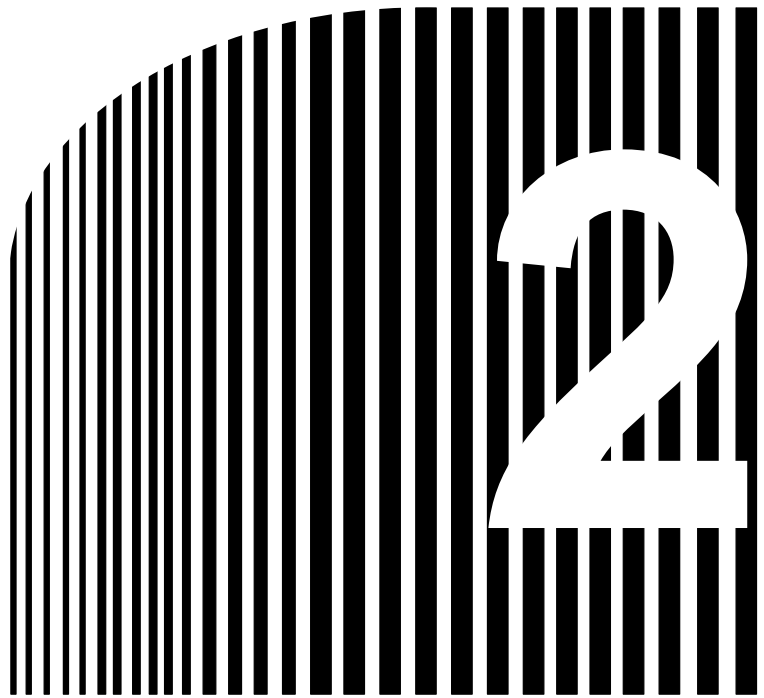

Chapter 2

• Installation •

2-1 Installation Site Precautions

2-2 Braking Unit Mounting Dimensions

2-3 Braking Resistor Unit Mounting Dimensions

2-1 Installation Site Precautions

Do not install the Braking Unit or Braking Resistor Unit in locations subject to the following conditions:

- Rain, water drops, or oil drops
- Direct sunlight
- Harmful gases or liquids
- Excessive dust, salt, or iron particles
- Excessive vibration
- Temperatures or humidities outside of the specified ranges
- Excessive electromagnetic noise, such as occurs near welding machines
- Radioactive materials
- Flammable materials

To take full advantage of the functions of the Braking Unit and Braking Resistor Unit, install the Units in a location satisfying the following conditions:

- Ensure that there is sufficient space between the Units and surrounding objects, as shown in the installation diagram.
- The Braking Resistor Unit generates heat. Provide sufficient space between the Units and devices that are sensitive to heat.
- Install the Units in the orientation shown in the installation diagrams.

2-2 Braking Unit Mounting Dimensions

• 3G3IV-PCDBR2015B/2022B/4030B/4045B

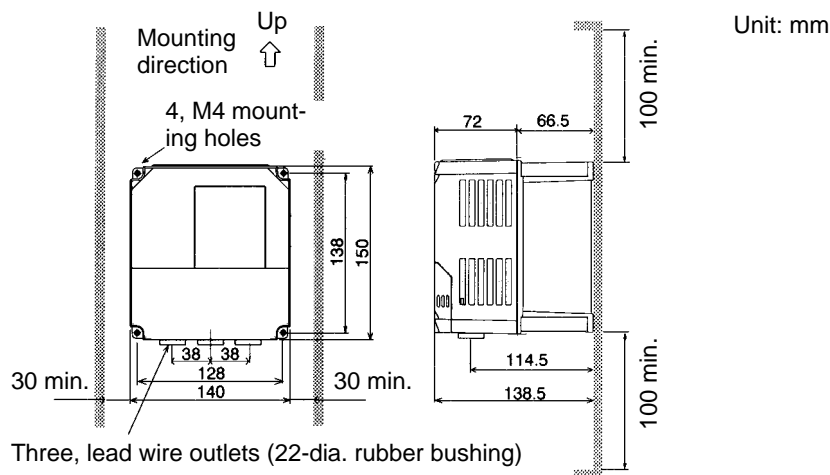

Installation Diagram

Weight: 1.8 kg

● 3G3IV-PCDBR2110B

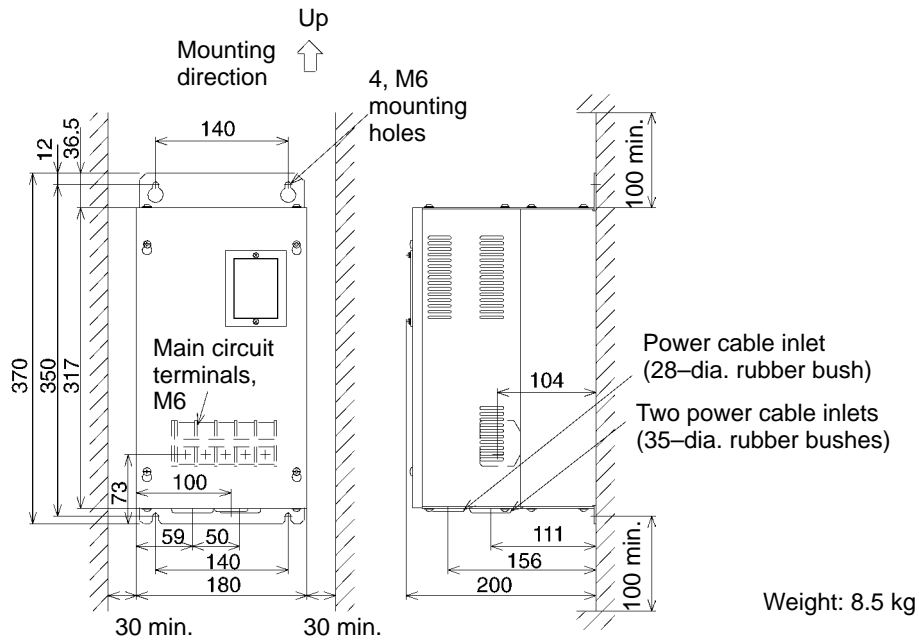

● 3G3IV-PCDBR4220B

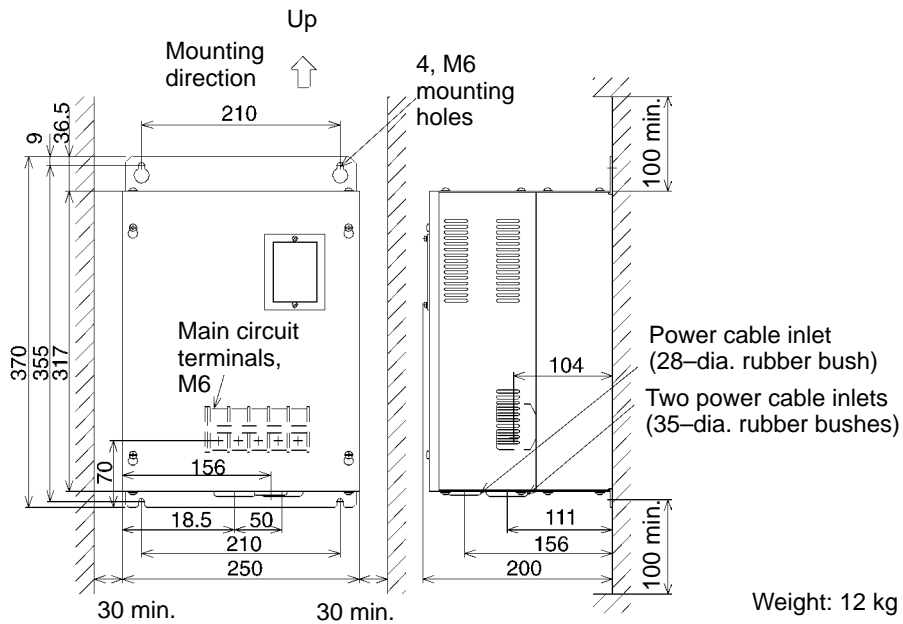

2-3 Braking Resistor Unit Mounting Dimensions

● Braking Resistor Units for 0.4 to 7.5-kW Inverters

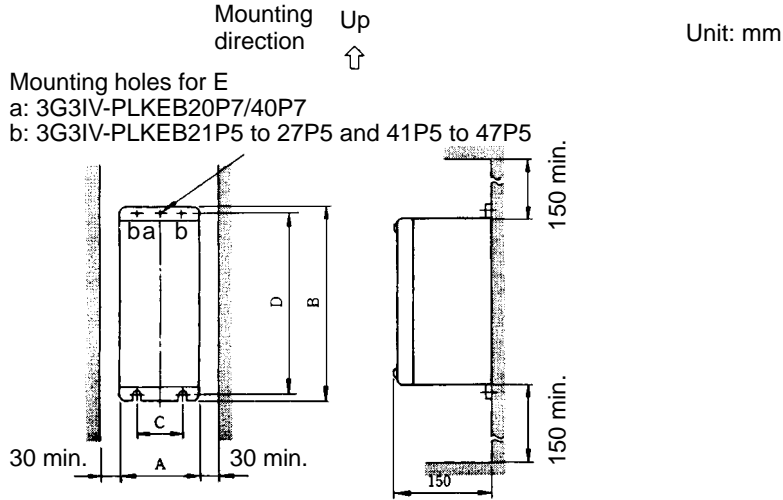

Braking Resistor Unit Model 3G3IV-PLKEB□		Dimensions in mm					Weight in kg
		A	B	C	D	E	
200 V class	20P7	105	275	50	260	M5	3.0
	21P5	130	350	75	335	M5	4.5
	22P2	130	350	75	335	M5	4.5
	23P7	130	350	75	335	M5	5.0
	25P5	250	350	200	335	M6	7.5
	27P5	250	350	200	335	M6	8.5
400 V class	40P7	105	275	50	260	M5	3.0
	41P5	130	350	75	335	M5	4.5
	42P2	130	350	75	335	M5	4.5
	43P7	130	350	75	335	M5	5.0
	45P5	250	350	200	335	M6	7.5
	47P5	250	350	200	335	M6	8.5

● Braking Resistor Units for 11 to 45-kW Inverters

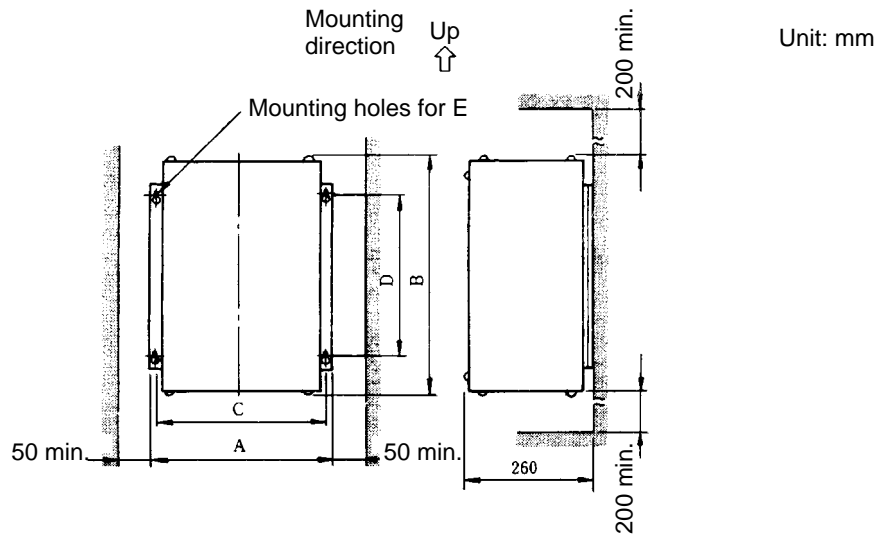

Braking Resistor Unit model 3G3IV-PLKEB□		Dimensions in mm					Weight in kg
		A	B	C	D	E	
200 V class	2011	266	543	246	340	M8	10
	2015	356	543	336	340	M8	15
	2018	446	543	426	340	M8	19
	2022	446	543	426	340	M8	19
400 V class	4011	350	412	330	325	M6	16
	4015	350	412	330	325	M6	18
	4018	446	543	426	340	M8	19
	4022	446	543	426	340	M8	19
	4030	356	956	336	740	M8	25
	4037	446	956	426	740	M8	33
	4045	446	956	426	740	M8	33

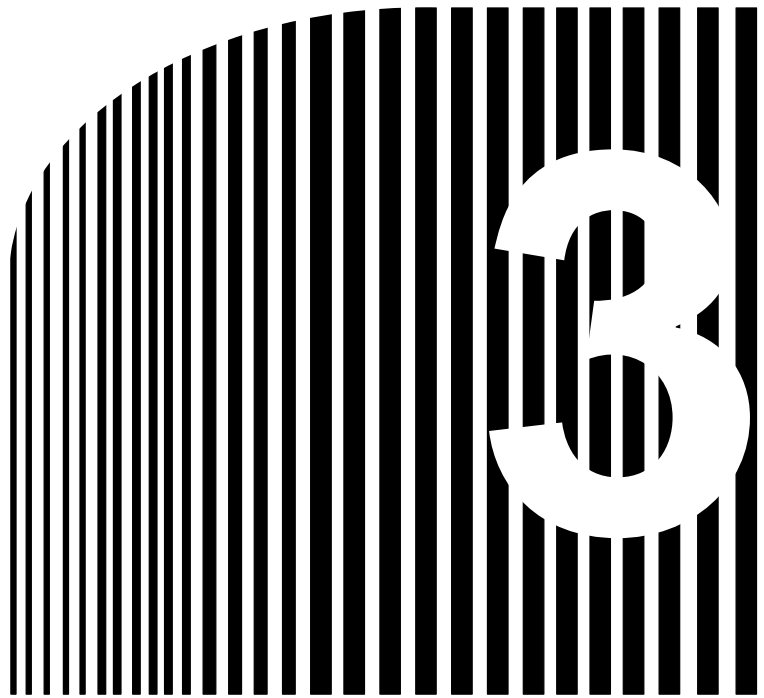

Chapter 3

• Braking Unit Covers •

3-1 Removing and Replacing the Terminal Cover

3-2 Removing and Replacing the Inner Cover

3-1 Removing and Replacing the Terminal Cover

To remove the terminal cover, grasp the cover at (1) on both sides and then lift in the direction of (2). To replace the cover, reverse the procedure.

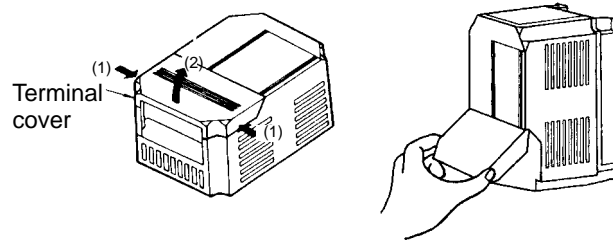

3-2 Removing and Replacing the Inner Cover

To remove the inner cover, remove the terminal cover first, then press down on the lever in the direction of (1) and lift the cover in the direction of (2). To replace the cover, reverse the procedure.

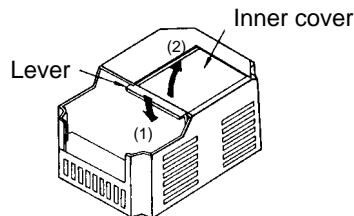

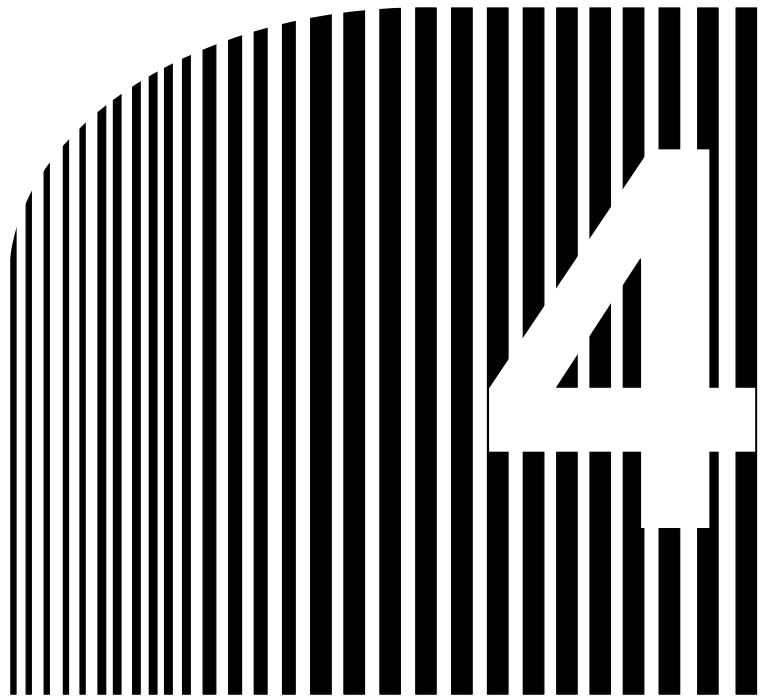

Chapter 4

• Nomenclature •

4-1 Braking Unit

4-2 Braking Resistor Unit

4-1 Braking Unit

● 3G3IV-PCDBR2015B/2022B/4030B/4045B Braking Unit

Note The diagram shows the Unit with the terminal cover and inner cover removed.

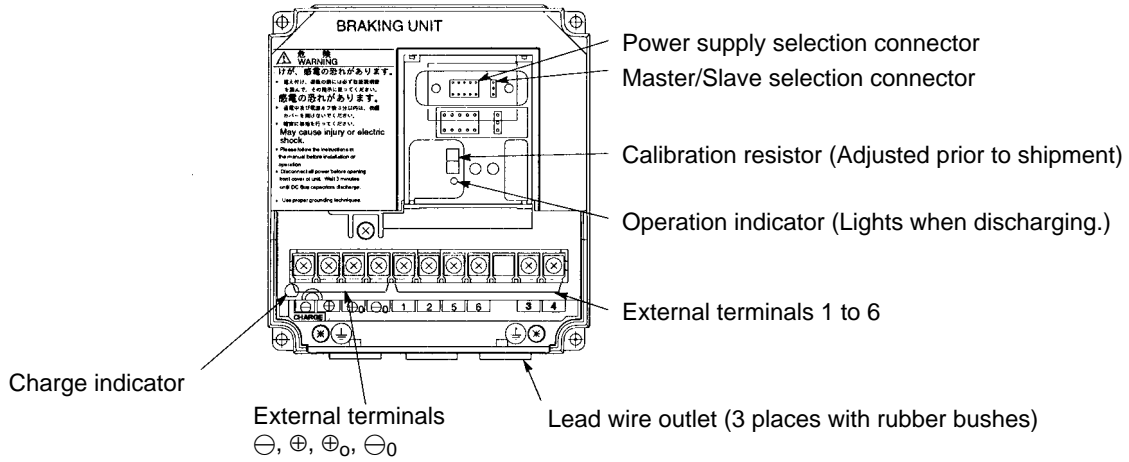

● Circuits and Wiring Specifications

Circuits	Terminal labels	Wire size in mm ² (AWG)	Wire type	Terminal screws	Tightening torque in N·m
Main circuits	\ominus , \oplus , \oplus_0 , \ominus_0	3.5 to 5.5 (12 to 10)	600-V vinyl sheathed wire	M4	1.2
Control circuits	1, 2, 3, 4, 5, 6	0.75 to 2 (18 to 14)			

● 3G3IV-PCDBR2110B Braking Unit

Note The diagram shows the Unit with the terminal cover and blind cover removed.

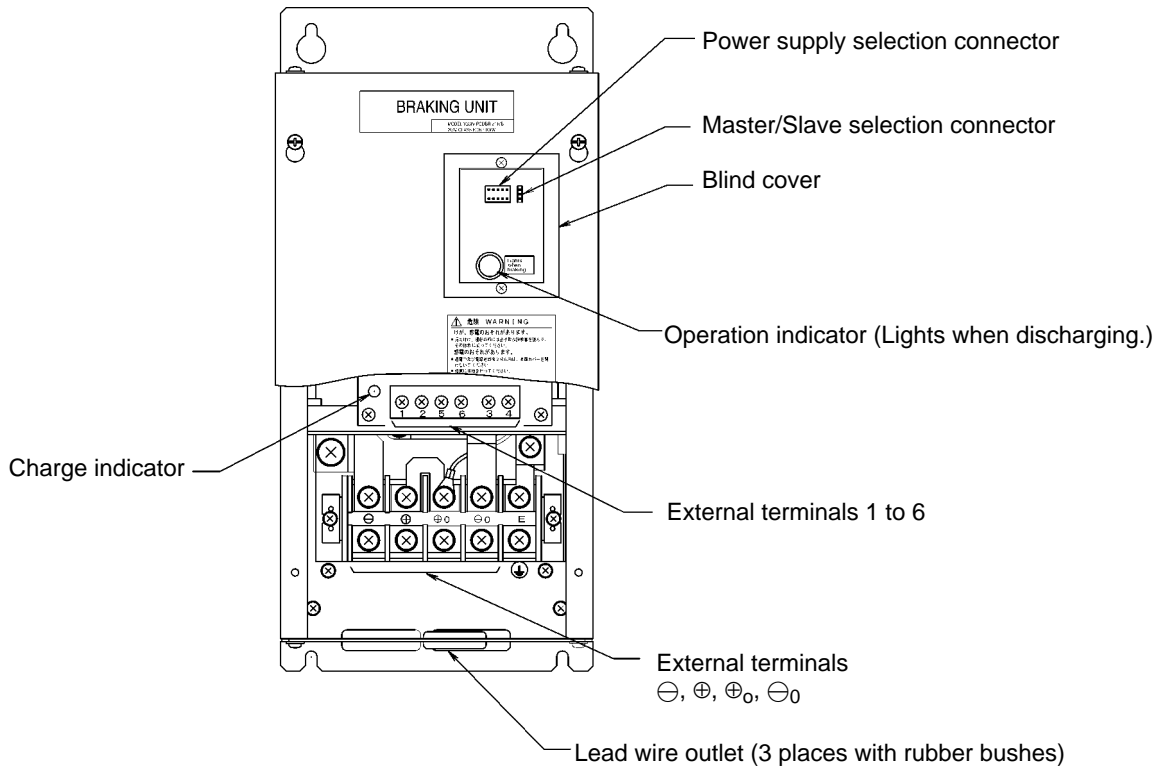

● Circuits and Wiring Specifications

Circuits	Terminal labels	Wire size in mm ² (AWG)	Wire type	Terminal screws	Tightening torque in N·m
Main circuits	⊕, ⊕ ₀	22 (4)	600-V vinyl sheathed wire	M4	1.2
	⊖, ⊖ ₀	8 to 14 (8 to 6) (See note.)			
Control circuits	1, 2, 3, 4, 5, 6	0.75 to 2 (18 to 14)			

Note For the 8 to 14-mm (AWG8 to AWG6) wires, use a 600-V cross-linked polyethylene-insulated vinyl-sheathed cable, UL 1283 heat-resistant vinyl-sheathed cable, or the equivalent.

● 3G3IV-PCDBR4220B Braking Unit

Note The diagram shows the Unit with the terminal cover and blind cover removed.

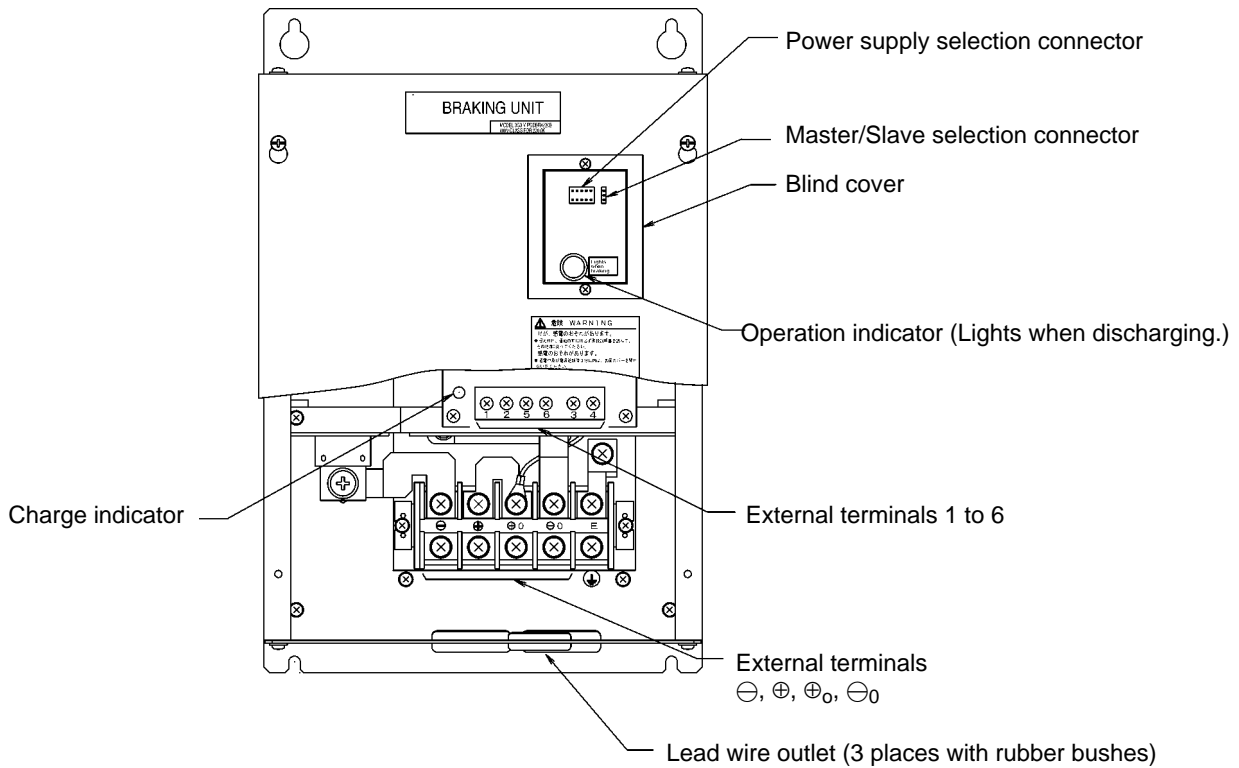

● Circuits and Wiring Specifications

Circuits	Terminal labels	Wire size in mm ² (AWG)	Wire type	Terminal screws	Tightening torque in N·m
Main circuits	⊕, ⊕ ₀	22 (4)	600-V vinyl sheathed wire	M4	1.2
	⊖, ⊖ ₀	8 to 14 (8 to 6) (See note.)			
Control circuits	1, 2, 3, 4, 5, 6	0.75 to 2 (18 to 14)			

Note For the 8 to 14-mm (AWG8 to AWG6) wires, use a 600-V cross-linked polyethylene-insulated vinyl-sheathed cable, UL 1283 heat-resistant vinyl-sheathed cable, or the equivalent.

4-2 Braking Resistor Unit

● 3G3IV-PLKEB20P7 to 27P5 and 3G3IV-PLKEB40P7 to 4015
Braking Resistor Units

Note The diagram shows the Unit with the front cover removed.

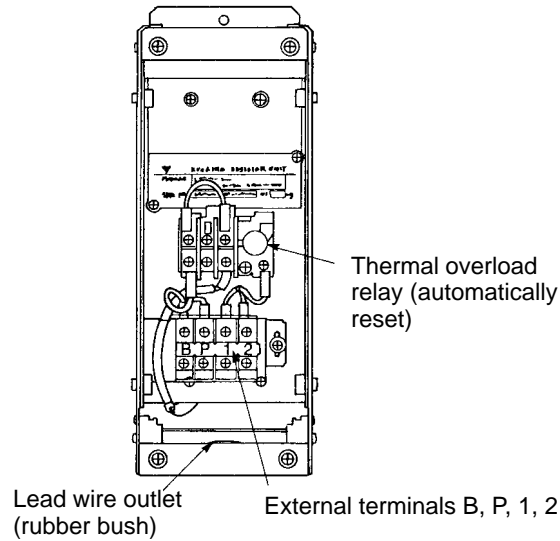

● Circuits and Wiring Specifications

Circuits	Terminal labels	Wire size in mm ² (AWG)	Wire type	Terminal screws	Tightening torque in N·m
Main circuits	B, P	3.5 to 5.5 (12 to 10)	600-V vinyl sheathed wire	M4	1.2
Control circuits	1, 2	0.75 to 2 (18 to 14)		M4	

● 3G3IV-PLKEB2011 to 2022 and 3G3IV-PLKEB4018 to 4045
Braking Resistor Units

Note The diagram shows the Unit with the front cover removed.

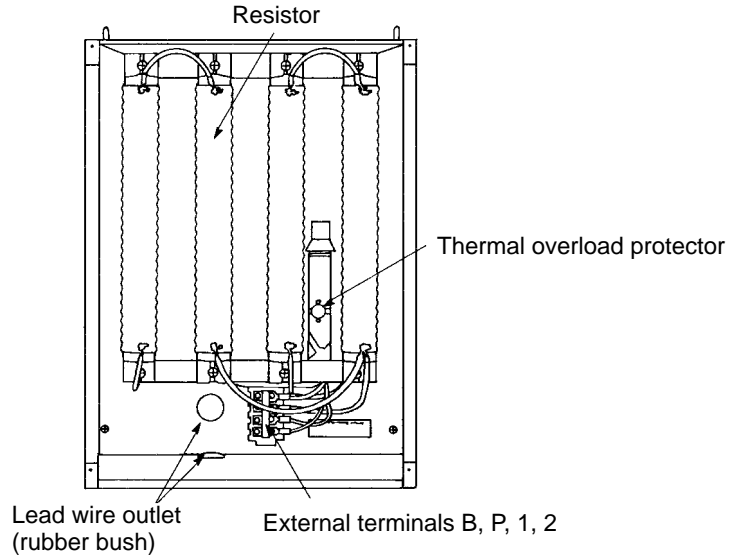

● Circuits and Wiring Specifications

Circuits	Terminal labels	Wire size in mm ² (AWG)	Wire type	Terminal screws	Tightening torque in N·m
Main circuits	B, P	3.5 to 5.5 (12 to 10)	600-V vinyl sheathed wire	M5	2.0
Control circuits	1, 2	0.75 to 2 (18 to 14)		M4	1.2

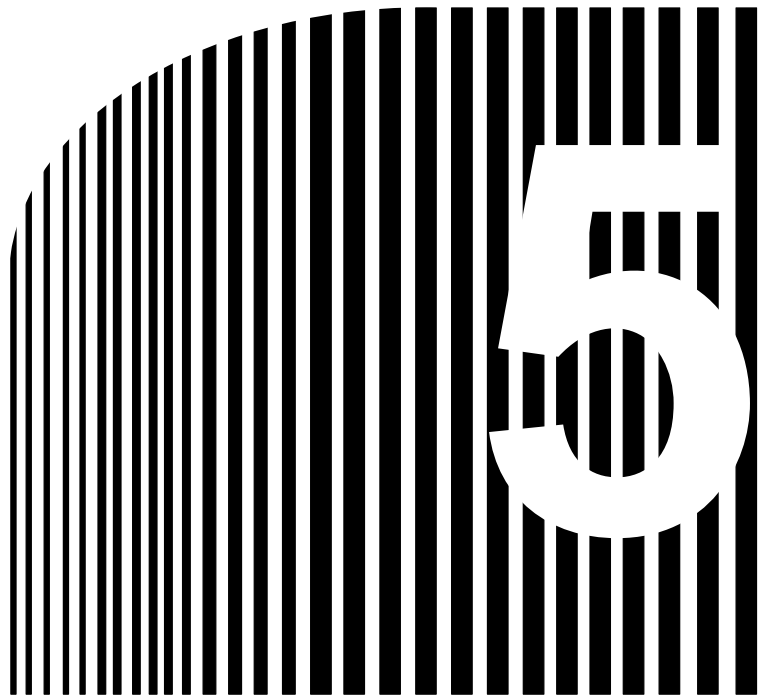

Chapter 5

• Wiring •

- 5-1 Wiring Lead-in Method
- 5-2 Separation from Signal Lines
- 5-3 Wiring Distance
- 5-4 Grounding
- 5-5 Wiring between Units

5-1 Wiring Lead-in Method

Lead in the wires through the knockout holes at the Unit bottom. The knockout holes are provided with rubber bushes; cut the rubber bush crosswise in the middle with a blade and lead the wires through.

5-2 Separation from Signal Lines

A strong noise component is superimposed on the Braking Resistor Unit and Braking Unit wiring. Separate the Units from signal lines that are sensitive to noise.

5-3 Wiring Distance

The wiring distance between the Braking Resistor Unit and Braking Unit or Braking Unit and Inverter must as shown in the following diagram. Make sure to bundle the wires between the Units.

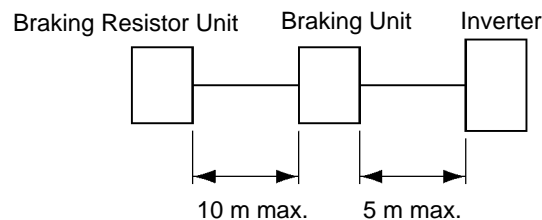

5-4 Grounding

- Mount the Braking Resistor Unit to a grounded metallic plate. When the Unit cannot be mounted to a grounded metallic plate, pull out the lead wire from the mounting screw section to ground.
- Always ground the ground terminal properly to a ground resistance of 100 Ω maximum for 200 V-class systems and to a ground resistance of 10 Ω maximum for 400 V-class systems.
- Use the size of ground cable specified in local regulations.

5-5 Wiring between Units

The following diagrams show examples of wiring between the Braking Unit, Braking Resistor Unit, and Inverter. Thoroughly read the information on the previous page and confirm that all wiring is designed and executed correctly.

Note Even if a non-OMRON braking resistor unit is used, it must be provided with thermal overload relay protection.

● **Connecting the Braking Resistor Unit**

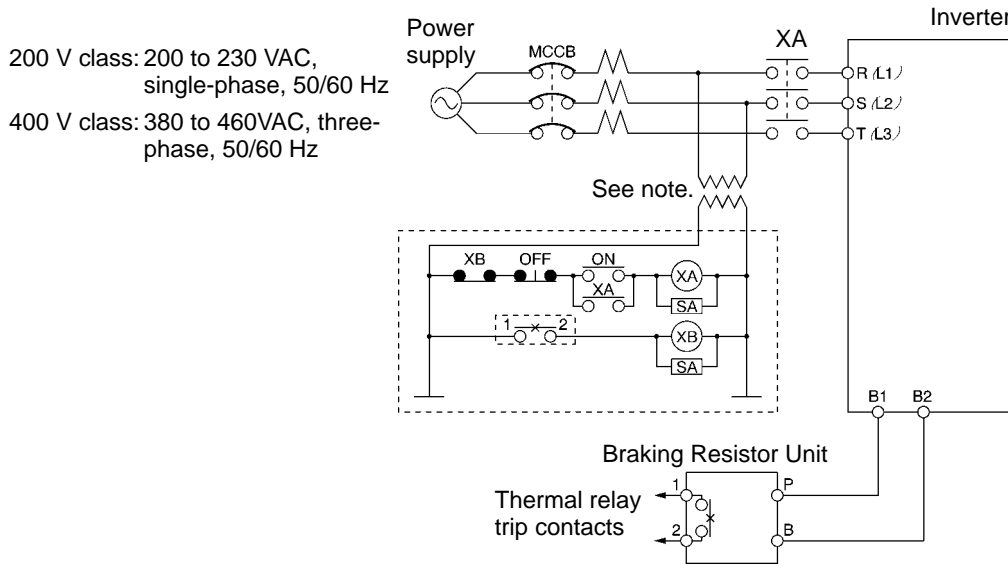

Note Connect a 400/200 transformer for 400 V-class Inverters.

● **Connecting the Braking Unit and Braking Resistor Unit**

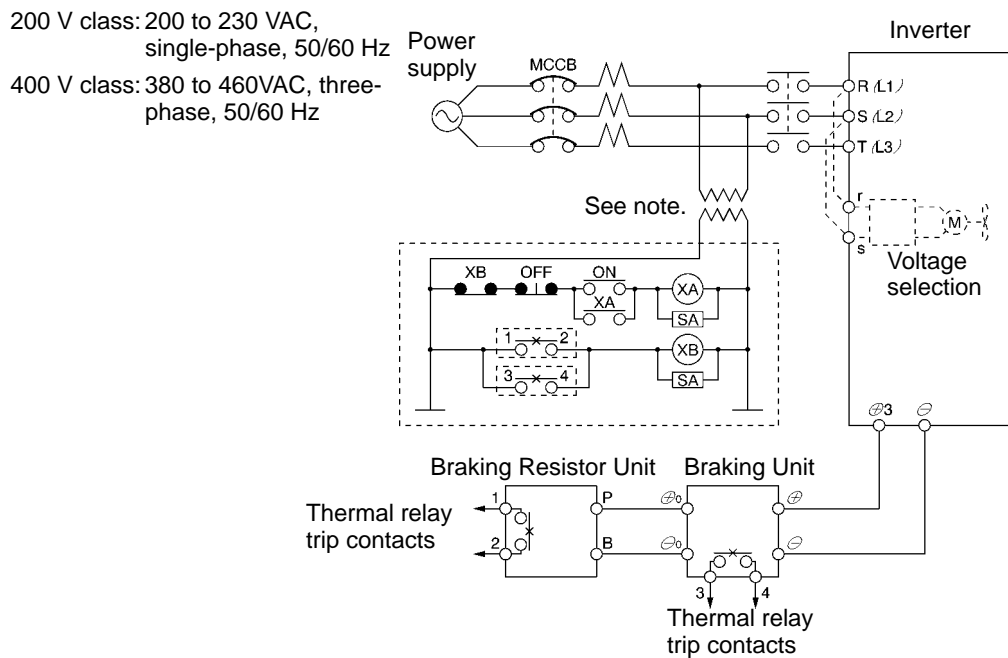

Note Connect a 400/200 transformer for 400 V-class Inverters.

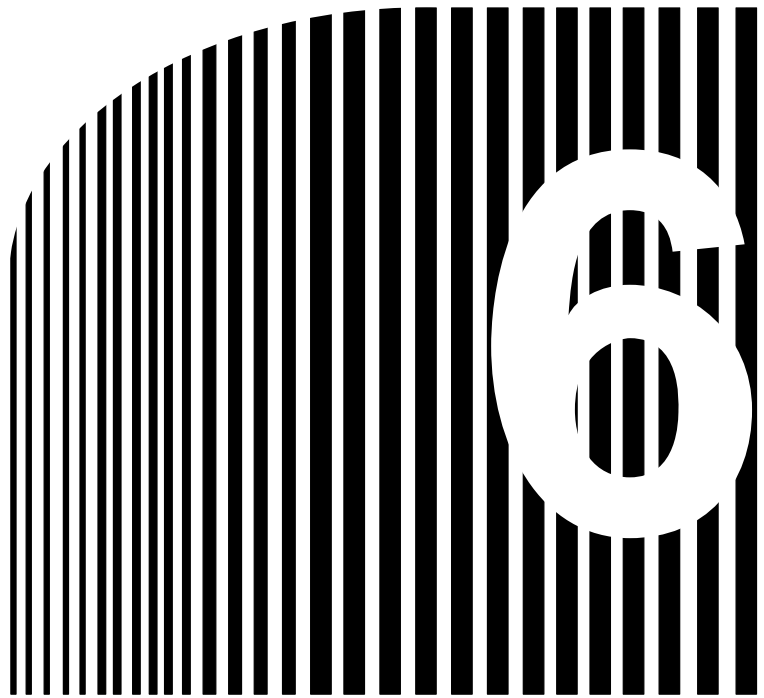

Chapter 6

• Settings •

6-1 Power Supply Selection Connector

6-2 Master/Slave Selection Connector

There is no need to adjust the Braking Unit or Braking Resistor Unit. Do not perform any adjustments to the Units except to set the power supply selection connector on the Braking Unit.

6-1 Power Supply Selection Connector

The power supply selection connector may need to be changed depending on the power supply voltage of the main circuits. The relationship between the power supply voltage and the settings of the selection connector is shown in the following tables. Set the connector in the correct position for the power supply voltage being used.

The factory setting is as follows:

- 200 V class: 220 V
- 400 V class: 440 V

Refer to *Chapter 3 Braking Unit Covers* for information on removing the terminal cover and inner cover.

200 V class power supply voltage	Braking start voltage (PN bus bar voltage)
230 V	380 V (typical)
220 V	365 V (typical)
208 V	345 V (typical)
200 V	330 V (typical)

400 V class power supply voltage	Braking start voltage (PN bus bar voltage)
460 V	760 V (typical)
440 V	730 V (typical)
415 V	690 V (typical)
400 V	660 V (typical)
380 V	630 V (typical)

Note The allowable voltage fluctuation is $\pm 10\%$.

● Power Supply Setting on 3G3IV-PCDBR2015B/2022B/4030B/4045B Braking Unit

Note The diagram shows the Unit with the terminal cover and inner covers removed.

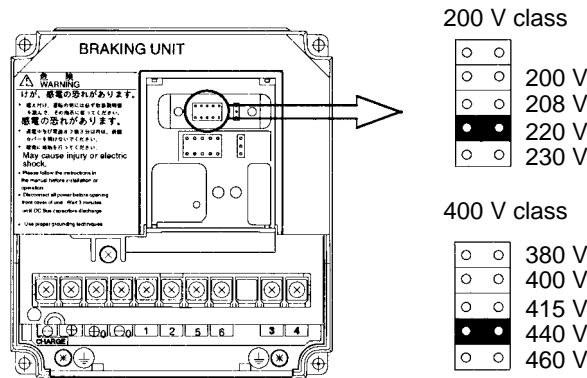

● Power Supply Setting on 3G3IV-PCDBR2110B/4220B Braking Unit

Note The diagram shows the Unit with the terminal cover and blind cover removed.

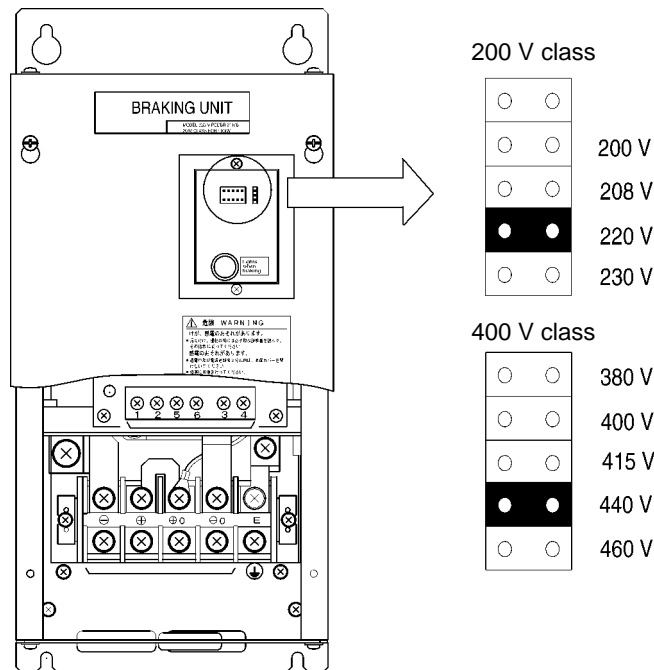

6-2 Master/Slave Selection Connector

The Unit is factory-set as a master. The Unit can normally be used without changing the setting of this connector.

The slave setting is used when connecting Braking Units in parallel so that the braking start voltages are the same. Refer to *Chapter 7 Connecting Braking Units in Parallel* for details.

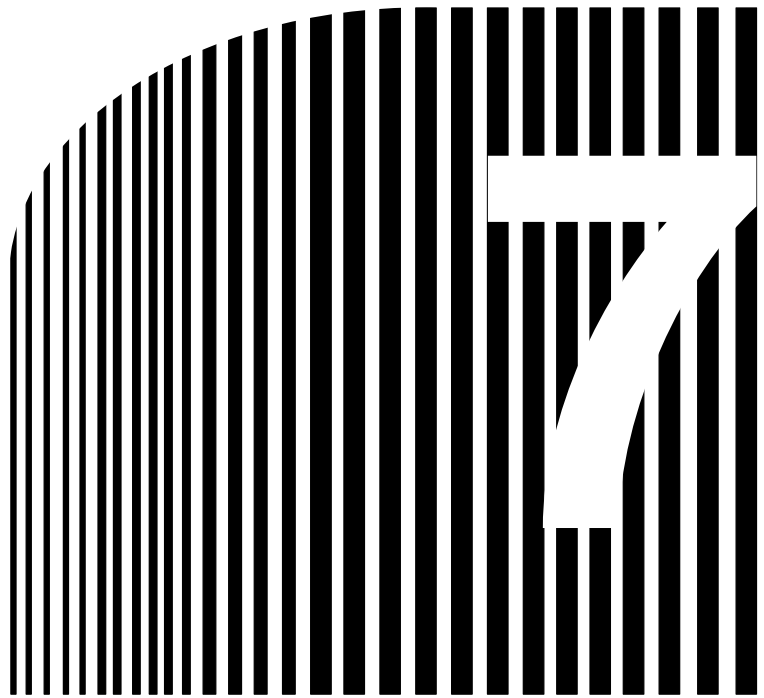

Chapter 7

- **Connecting Braking Units in Parallel** •

When connecting two or more Braking Units in parallel, connect the Units and set the master/slave selection connector as follows:

- Braking Units have a master/slave selection connector. Set the selection connector to the master setting on only one of the Braking Units (Braking Unit 1, below). Set the selection connector to the slave setting on the other Braking Units (Braking Units 2 and 3, below).
- Connect the thermal relays on the Braking Resistor Units in parallel and the thermal relays on the Braking Units in parallel. Wire correctly according to instructions in *5-5 Wiring between Units*.
- Use twisted-pair wires of 1 m or less to connect terminals 5 and 6 to terminals 1 and 2 of the Braking Units.
- Up to 10 Braking Units can be wired in parallel.

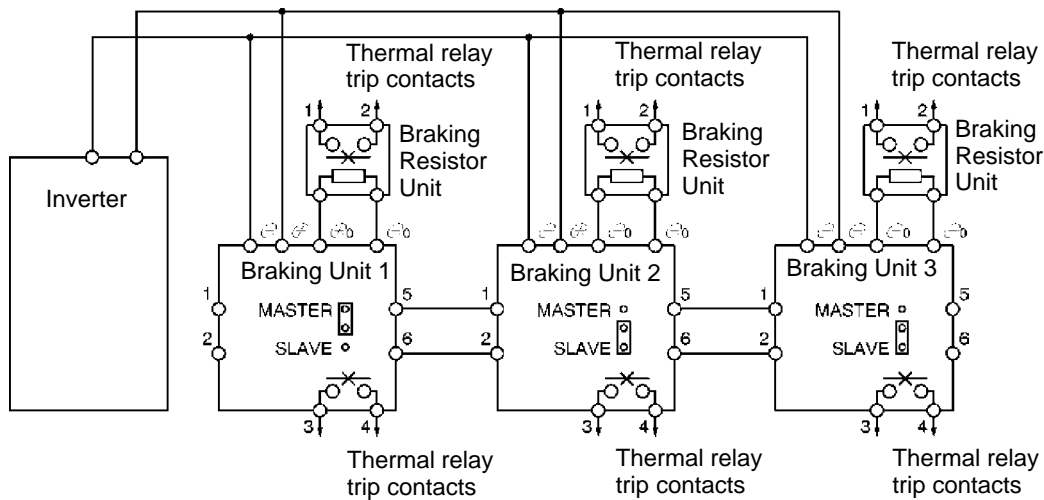

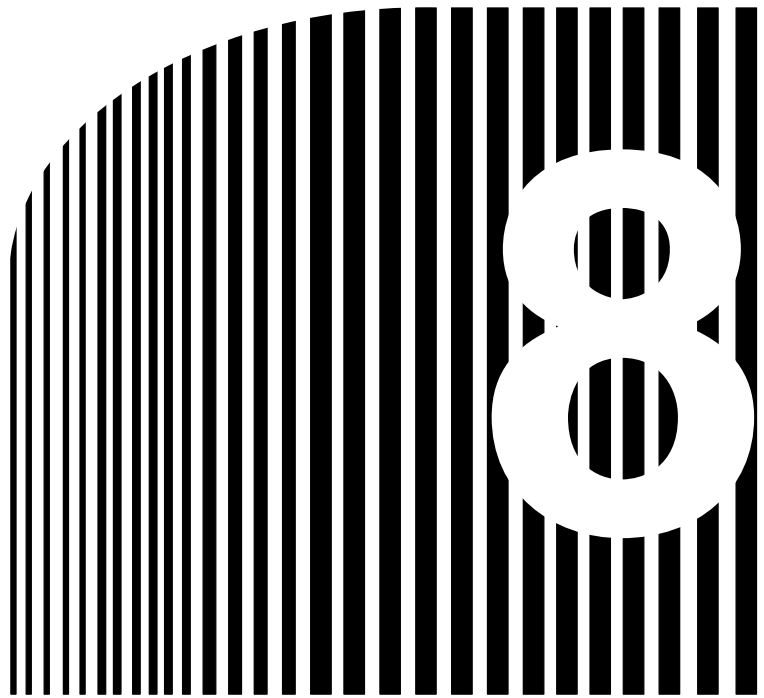

Chapter 8

• **Operation** •

Confirm that the desired braking characteristics are being obtained. The operation indicator on the Braking Unit will light when the Unit is operating. Use this indicator to confirm operation.

● High Voltages

 **WARNING** High voltages are present both inside the Braking Unit and on the terminal block. Always operate the Unit with the covers attached. Operation without the covers attached presents an immediate danger of electric shock.

● Parameters

The following Inverter parameters must be set when using a Braking Resistor Unit.

3G3FV-series Inverters

Set L8-01 (DB resistor protection) to 0 (Disabled: Braking resistor is not used or the Braking Resistor Unit is used).

Set L3-04 (Stall prevention during deceleration) to 0 (Disabled: Deceleration as set).

3G3HV-series Inverters

Set n079 (DB resistor protection) to 0 (Disabled: Braking resistor is not used or the Braking Resistor Unit is used).

Set n070 (Stall prevention during deceleration) to 0 (Disabled: Deceleration as set).

3G3EV-series Inverters

Set n33 (Stall prevention during deceleration) to 1 (Disabled: Deceleration as set).

Note 1. L8-01 or n079 is enabled when using a braking resistor without thermal relay trip contacts.

Note 2. Stall prevention (L3-04, n070, or n33) is enabled when a Braking Resistor Unit is not used and the deceleration time can not be reduced.

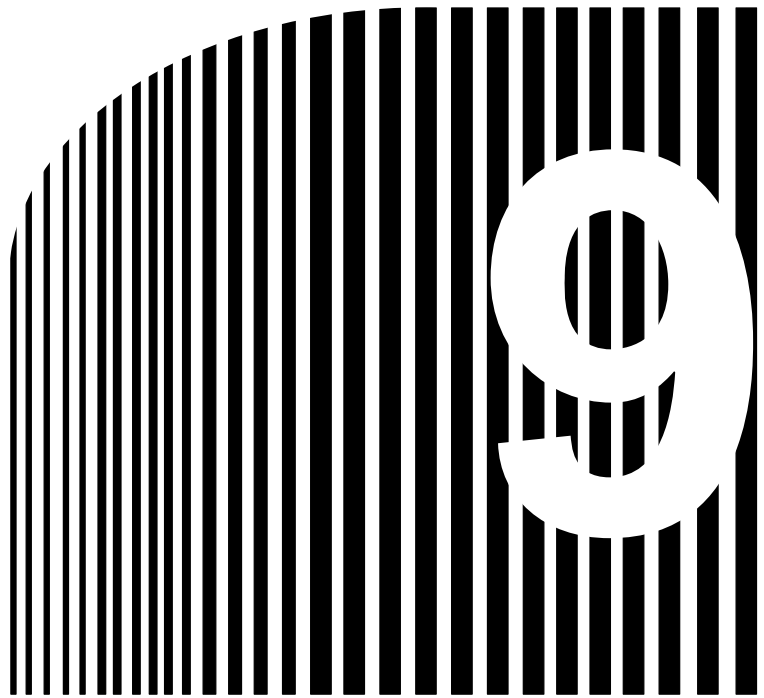

Chapter 9

• **Troubleshooting** •

Fault status	Cause	Corrective action
Braking Resistor Unit overload relay (or thermal overload protector) trips when not decelerating.	<ul style="list-style-type: none"> • Without Braking Unit The main circuit discharge transistor in the Inverter is short circuited.	Replace the Inverter.
	<ul style="list-style-type: none"> • With Braking Unit The main circuit discharge transistor in the Braking Unit is short circuited.	Replace the Unit.
	Improper Braking Unit power supply selection connector setting (The power supply voltage is greater than the voltage set on the power supply voltage selection connector.)	Set the power supply selection connector again.
Inverter trips at overvoltage (OV).	Insufficient Braking Resistor Unit capacity	Check the braking conditions again.
	Improper wiring	Check and repair the wiring.
	Braking Unit fault	Replace the Unit.
Braking Resistor Unit overload relay (or thermal protector) sometimes trips.	Insufficient Braking Resistor Unit capacity	Check the braking conditions again.
Braking Unit trips due to heat sink overheat.	Excessive start/stop switching frequency	Check the operating conditions again.
	Excessive load inertia	
	Improper combination of Braking Unit and Braking Resistor Unit	Check the combination.
	Ambient temperature above 40°C	Reduce the ambient temperature.

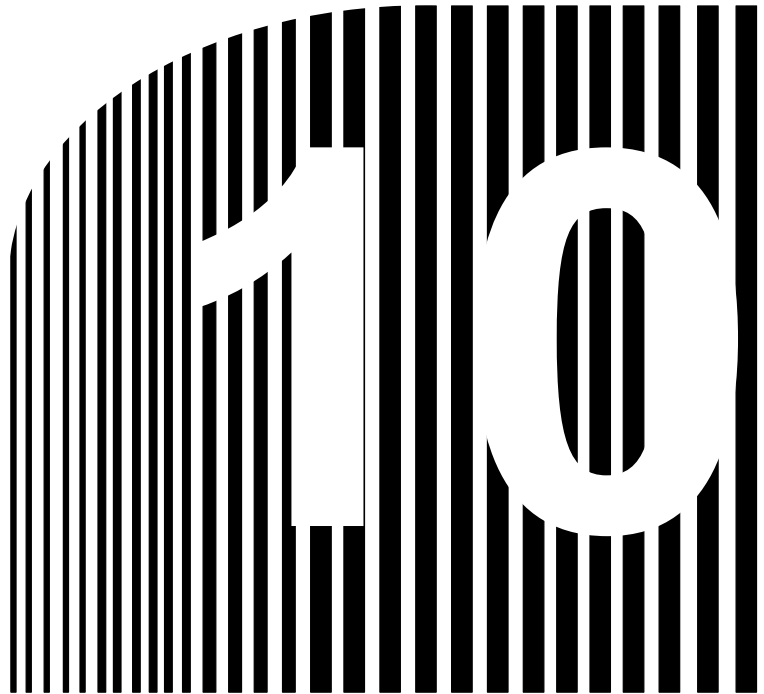

Chapter 10

• Specifications •

10-1 Braking Unit–Braking Resistor Unit Application Tables

10-2 Braking Unit Specifications

10-3 Braking Resistor Unit Specifications

10-1 Braking Unit–Braking Resistor Unit Application Tables

● 200 V Class

Inverter Max. appli- cable Motor Unit HP (kW)	Braking Unit		Braking Resistor Unit			Braking torque (10% ED) %
	Model 3G3IV- PCDBR□	Number used	Model 3G3IV- PLKEB□	Resistor speci- fications	Number used	
0.4 (0.5)	---	---	20P7	70 W, 200 Ω	1	220
0.75 (1)	---	---	20P7	70 W, 200 Ω	1	125
1.5 (2)	---	---	21P5	260 W, 100 Ω	1	125
2.2 (3)	---	---	22P2	260 W, 70 Ω	1	120
3.7 (5)	---	---	23P7	390 W, 40 Ω	1	125
5.5 (7.5)	---	---	25P5	520 W, 30 Ω	1	115
7.5 (10)	---	---	27P5	780 W, 20 Ω	1	125
11 (15)	2015B	1	2011	2,400 W, 13.6 Ω	1	125
15 (20)	2015B	1	2015	3,000 W, 10 Ω	1	125
18.5 (25)	2022B	1	2018	4,800 W, 8 Ω	1	125
22 (30)	2022B	1	2022	4,800 W, 6.8 Ω	1	125
30 (40)	2015B	2	2015	4,800 W, 10 Ω	2	125
37 (50)	2015B	2	2015	3,000 W 10 Ω	2	100
45 (60)	2022B	2	2022	4,800 W, 6.8 Ω	2	120
55 (75)	2022B	2	2022	4,800 W, 6.8 Ω	2	100
75 (100)	2110B	1	2022	4,800 W, 6.8 Ω	3	110
90 (120)	2110B	1	2022	4,800 W, 6.8 Ω	4	120
110 (150)	2110B	1	2018	4,800 W, 8 Ω	5	100

● 400 V Class

Inverter	Braking Unit		Braking Resistor Unit			Braking torque (10% ED) %	
	Max. applicable Motor Unit HP (kW)	Model 3G3IV-PCDBR□	Number used	Model 3G3IV-PLKEB□	Resistor specifications		Number used
0.4 (0.5)	---	---	---	40P7	70 W, 750 Ω	1	230
0.75 (1)	---	---	---	40P7	70 W, 750 Ω	1	130
1.5 (2)	---	---	---	41P5	260 W, 400 Ω	1	125
2.2 (3)	---	---	---	42P2	260 W, 250 Ω	1	135
3.7 (5)	---	---	---	43P7	390 W, 150 Ω	1	135
5.5 (7.5)	---	---	---	45P5	520 W, 100 Ω	1	135
7.5 (10)	---	---	---	47P5	780 W, 75 Ω	1	130
11 (15)	---	---	---	4011	1,040 W, 50 Ω	1	135
15 (20)	---	---	---	4015	1,560 W, 40 Ω	1	125
18.5 (25)	4030B	1	---	4018	4,800 W, 32 Ω	1	125
22 (30)	4030B	1	---	4022	4,800 W, 27.2 Ω	1	125
30 (40)	4030B	1	---	4030	6,000 W, 20 Ω	1	125
37 (50)	4045B	1	---	4037	9,600 W, 16 Ω	1	125
45 (60)	4045B	1	---	4045	9,600 W, 13.6 Ω	1	125
55 (75)	4030B	2	---	4030	6,000 W, 20 Ω	2	135
75 (100)	4045B	2	---	4045	9,600 W, 13.6 Ω	2	145
90 (120)	4220B	1	---	4030	9,600 W, 13.6 Ω	3	100
110 (150)	4220B	1	---	4030	6,000 W, 20 Ω	3	100
132 (165)	4220B	1	---	4045	9,600 W, 13.6 Ω	4	140
160 (200)	4220B	1	---	4045	9,600 W, 13.6 Ω	4	140
180 (240)	4220B	1	---	4045	9,600 W, 13.6 Ω	4	120
220 (300)	4220B	1	---	4037	9,600 W, 16 Ω	5	110
300 (400)	4220B	2	---	4045	9,600 W, 13.6 Ω	6	110

10-2 Braking Unit Specifications

■ 200 V Class Braking Units

Voltage		200 V class		
Model 3G3IV-PCDBR□		2015B	2022B	2110B
Output characteristics	Max. applicable motor capacity (kW)	15	22	110
	Max. discharge current (A) (peak value) (see note)	40	60	250
	Rated discharge current (A) (continuous)	15	20	80
	Braking start voltage	330/345/365/380 V ± 3 V		
	Max. hysteresis	Approx. 8 V		
Power supply	VDC	243 (1.35 × 200 × 0.9) to 400 V peak		
Protective functions	Cooling fins overheating	Thermostat protection		
	Power charging indicator	Charging indicator stays ON until bus voltage drops below 50 V.		
Environmental conditions	Location	Indoor (without no corrosive gases or dust)		
	Ambient temperature	−10 to 40 °C (no icing)		
	Storage temperature	−20 to 60 °C		
	Humidity	90% RH (no condensation)		
	Vibration	9.8 m/s ² (1G) at 10 to 20 Hz 2 m/s ² (0.2G) at 20 to 50 Hz		
Degree of protective		Wall-mounted enclosed structure (NEMA1)		
Heat loss (W)		32	38	64

Note Loading time rate for the maximum discharge current must be 10% ED or less for a maximum of 10 s.

■ 400 V Class Braking Units

Voltage		400 V class		
Model 3G3IV-PCDBR□		4030B	4045B	4220B
Output characteristics	Max. applicable motor capacity (kW)	30	45	220
	Max. discharge current (A) (peak value) (see note)	40	60	250
	Rated discharge current (A) (continuous)	15	18	80
	Braking start voltage	630/660/690/730/760 V ± 6 V		
	Max. hysteresis	Approx. 16 V		
Power supply	VDC	460 (1.35 × 380 × 0.9) to 800 V peak		
Protective functions	Cooling fins overheating	Thermostat protection		
	Power charging indicator	Charging indicator stays ON until bus voltage drops below 50 V.		
Environmental conditions	Location	Indoor (without no corrosive gases or dust)		
	Ambient temperature	-10 to 40 °C (no icing)		
	Storage temperature	-20 to 60 °C		
	Humidity	90% RH (no condensation)		
	Vibration	9.8 m/s ² (1G) at 10 to 20 Hz 2 m/s ² (0.2G) at 20 to 50 Hz		
Degree of protective		Wall-mounted enclosed structure (NEMA1)		
Heat loss (W)		54	59	71

Note Loading time rate for the maximum discharge current must be 10% ED or less for a maximum of 10 s.

10-3 Braking Resistor Unit Specifications

Model 3G3IV- PLKEB□	Specifications		Allowable average power con- sumption (W)	Allowable average cur- rent (effec- tive value) (A)	Allowable ambient temperature
20P7	200 V class	700 W 200 Ω	30	0.39	-10 to 50 °C
21P5		260 W 100 Ω	60	0.77	
22P2		260 W 70 Ω	89	1.1	
23P7		390 W 40 Ω	150	1.9	
25P5		520 W 30 Ω	220	2.7	
27P5		780 W 20 Ω	300	3.9	
2011		2,400 W 13.6 Ω	440	5.7	
2015		3,000 W 10 Ω	600	7.7	
2018		4,800 W 8 Ω	740	9.6	
2022		4,800 6.8 Ω	880	11.4	
40P7		400 V class	70 W 750 Ω	30	
41P5	260 W 400 Ω		60	0.39	
42P2	260 W 250 Ω		89	0.60	
43P7	390 W 150 Ω		150	1.0	
45P5	520 W 100 Ω		220	1.5	
47P5	780 W 75 Ω		300	2.0	
4011	1,040 W 50 Ω		440	3.0	
4015	1,560 W 40 Ω		600	3.9	
4018	4,800 W 32 Ω		740	4.8	
4022	4,800 W 27.2 Ω		880	5.7	
4030	6,000 W 20 Ω		1,200	7.7	
4037	9,600 W 16 Ω		1,500	9.7	
4045	9,600 W 13.6 Ω		1,800	11.5	

OMRON Corporation
Control Devices Division H.Q.
Shiokoji Horikawa, Shimogyo-ku,
Kyoto, 600-8530 Japan
Tel: (81)75-344-7109/Fax: (81)75-344-7149

Regional Headquarters

OMRON EUROPE B.V.
Wegalaan 67-69, NL-2132 JD Hoofddorp
The Netherlands
Tel: (31)2356-81-300/Fax: (31)2356-81-388

OMRON ELECTRONICS LLC
1 East Commerce Drive, Schaumburg, IL 60173
U.S.A.
Tel: (1)847-843-7900/Fax: (1)847-843-8568

OMRON ASIA PACIFIC PTE. LTD.
83 Clemenceau Avenue,
#11-01, UE Square,
Singapore 239920
Tel: (65)6835-3011/Fax: (65)6835-2711

OMRON (CHINA) CO., LTD.
Room 2211, Bank of China Tower,
200 Yin Cheng Zhong Road,
PuDong New Area, Shanghai, 200120 China
Tel: (86)21-5037-2222/Fax: (86)21-5037-2200

OMRON

Authorized Distributor: