

It's so small!



Side view type

Front view type

Paper/Label Both 2D & 1D code compatible

Ultra-small multi code reader

V400-R series

- Multi-code reading that automatically recognizes major paper/label 1D and 2D codes
- 1.3 Mega pixels (SXGA) CMOS image sensor
- Aiming feature (Green LED) to quickly condition the reading area for recognition
- Front view/Side view types available for flexible installation

Example of supported code types

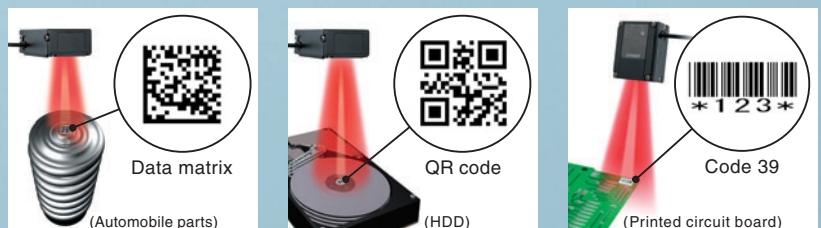

System configuration

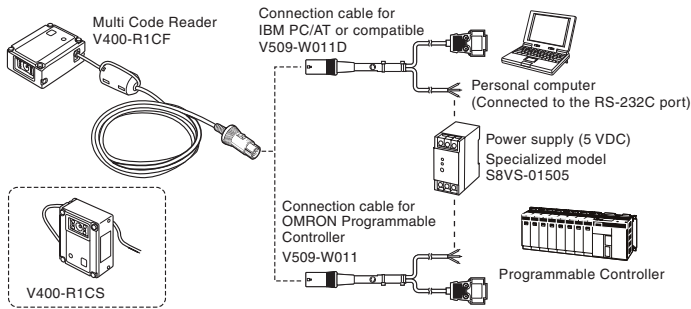

Item	Model	
Dedicated Cables (Order Separately)	SYSMAC D-sub 9-pin cable, 0.8m	V509-W011
	SYSMAC D-sub 9-pin cable, 5.0m	V509-W016
	IBM PC/AT or compatible D-sub 9-pin cable, 0.8m	V509-W011D
	IBM PC/AT or compatible D-sub 9-pin cable, 5.0m	V509-W016D

Dimensions (Unit: mm)

Multi Code Reader

Front view type V400-R1CF

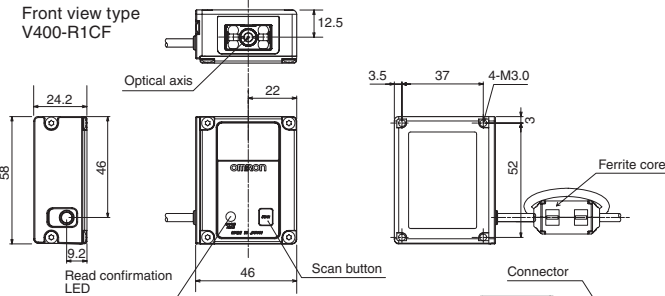

Side view type V400-R1CS

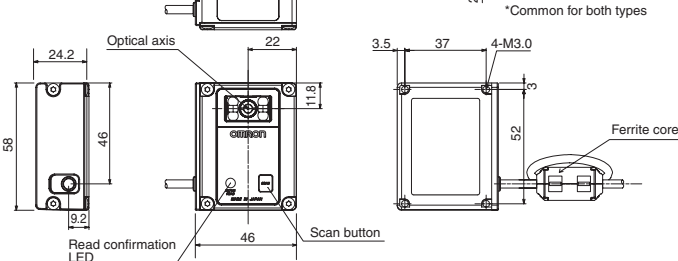

Mounting Bracket

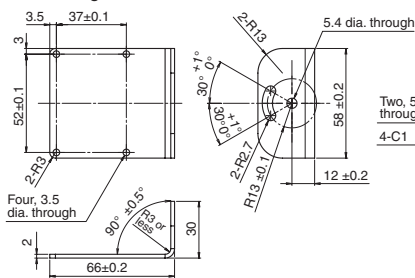

Mounting Base

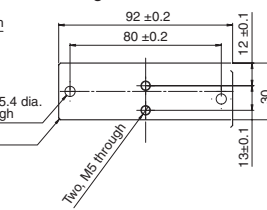

Specifications

Item	V400-R1CF	V400-R1CS
View direction	Front view	Side View
Applicable codes	2D code : QRCode, DataMatrix(ECC200), MicroQR, PDF417 Bar code : WPC(JAN/EAN/UPC-A/UPC-E), NW-7, ITF, STF(2 of 5bar), Code39, Code93, Code128, GS1 DataBar	
Resolution	Bar code : 0.1mm 2D code : 0.169mm	
Working distance (WD)	Approx.60mm	
Field of vision*	52 x 41	
Lighting	Red LED x 4 (wavelength 630nm)	
Image sensor	CMOS area sensor	
Effective pixels	1280 x 1024 pixels	
Power supply voltage	4.5 to 5.5 VDC	
Current consumption	Operation : 230mA Standby : 130mA	
Serial interface	RS-232C	
Ambient temperature	Operating : 0 to 45°C, Storage : -20 to 60°C	
Ambient humidity	Operating/storage : 25% to 85% (with no icing or condensation)	
Ambient environment	No corrosive gasses	
Weight	Approx.120g (Cables and accessories not included)	
Size	58 x 46 x 24.2	
I/O connector	DIN 8-pin connector	
Cable length	Approx.1.5m	

* At WD=60mm

Reading area

2D code

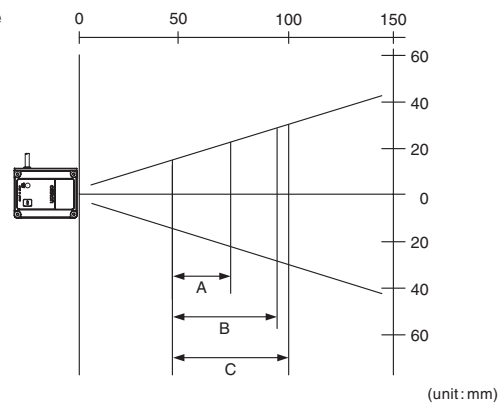

	Cell size	Reading distance	Field of view for that distance
A	0.169	45.0~70.0	31.5×21.5~47.0×32.0
B	0.339	45.0~90.0	31.5×21.5~59.3×40.4
C	0.508	45.0~100.0	31.5×21.5~65.4×44.6

*Reference value from using our standard label and testing environment

Bar code (typical examples)

Code type	Narrow bar width	Reading distance
Code39	0.1	45.0~70.0
Code128	0.2	45.0~80.0
JAN13	0.39	50.0~100.0

This document provides information mainly for selecting suitable models. Please read the *Instruction Sheet* carefully for information that the user must understand and accept before purchase, including information on warranty, limitations of liability, and precautions.

OMRON Corporation
Industrial Automation Company
Sensing Devices Division H.Q.
Application Sensors Division
Shiokoji Horikawa, Shimogyo-ku,
Kyoto, 600-8530 Japan
Tel: (81) 75-344-7068/Fax: (81) 75-344-7107

Regional Headquarters
OMRON EUROPE B.V.
Sensor Business Unit
Carl-Benz-Str. 4, D-71154 Nufringen,
Germany
Tel: (49) 7032-811-0/Fax: (49) 7032-811-199

OMRON Industrial Automation Global: www.ia.omron.com

OMRON ELECTRONICS LLC
One Commerce Drive Schaumburg,
IL 60173-5302 U.S.A.
Tel: (1) 847-843-7900/Fax: (1) 847-843-7787

OMRON ASIA PACIFIC PTE. LTD.
No. 438A Alexandra Road # 05-05/08 (Lobby 2),
Alexandra Technopark, Singapore 119967
Tel: (65) 6835-3011/Fax: (65) 6835-2711

OMRON (CHINA) CO., LTD.
Room 2211, Bank of China Tower,
200 Yin Cheng Zhong Road,
PuDong New Area, Shanghai, 200120, China
Tel: (86) 21-5037-2222/Fax: (86) 21-5037-2200

Authorized Distributor:

In the interest of product improvement,
specifications are subject to change without notice.

CSM_1_2_0612
Cat. No. Q158-E1

Printed in Japan